

UNOFFICIAL TRANSLATION

This text is an unofficial translation of the Dutch original. In case of any discrepancies, the Dutch original shall prevail.

Court of Appeal The Hague

Date 28 November 2017

DEFENCE ON APPEAL

in the matter of:

Case No. 200.197.079/01

THE RUSSIAN FEDERATION,
seated in Moscow, Russian Federation,
Appellee
counsel: prof. mr. A.J. van den Berg
local counsel: mr. J.A. Dullaart

versus:

HULLEY ENTERPRISES LIMITED,
Nicosia, Cyprus,

VETERAN PETROLEUM LIMITED,
Nicosia, Cyprus,

YUKOS UNIVERSAL LIMITED,
Douglas, Isle of Man,

Appellants, together referred to as: HVY
counsels: mrs. M.A. Leijten, M. Ynzonides en
A.W.P. Marsman
local counsel: mr. M.A. Leijten

Table of contents

I.	INTRODUCTION	8
A.	Structure of this Defence on Appeal	8
B.	Anticipation of the legal framework under Article 1065(1)(a) DCCP	9
C.	Summary of the main arguments Article 45 ECT (Jurisdiction Ground 1)	10
D.	The backgrounds; known and new facts and evidence	10
E.	The other grounds for setting aside	11
	(a) <i>HVY are not Investors and have not made an Investment within the meaning of Article 1(6) and (7) ECT (Jurisdiction Ground 2)</i>	12
	(b) <i>HVY's claims concern allegedly unlawful taxation measures and not taxes, and therefore fall outside the scope of the ECT pursuant to Article 21 ECT (Jurisdiction Ground 3)</i>	12
	(c) <i>Failure to comply with the mandate</i>	13
	(d) <i>Violation of the duty to state reasons</i>	14
	(e) <i>Contrary to public policy</i>	15
II.	GROUND FOR SETTING ASIDE 1 - NO VALID ARBITRATION AGREEMENT (ARTICLE 1065(1)(A) DCCP)	16
A.	Introduction	17
B.	The District Court interpreted Article 45(1) ECT correctly	21
	(a) <i>The ECT's entry into force requires ratification</i>	22
	(b) <i>Provisional application and the interpretation of Article 45(1) ECT</i>	27
	(c) <i>The District Court correctly ruled that Article 45 ECT provides for limited provisional application</i>	32
	(d) <i>The District Court's interpretation matches what had already been accepted as the only correct interpretation of Article 45(1) ECT at the time</i>	54
	(e) <i>The Tribunal's interpretation of the treaty leads to absurd consequences</i>	70
C.	The District Court correctly found that arbitration of HVY's claims is inconsistent with the Russian Constitution and Russian laws	71
	(a) <i>Introduction</i>	72
	(b) <i>It is inconsistent with the Russian Constitution to apply Article 26 ECT provisionally without the consent of Parliament</i>	78
	(c) <i>It is inconsistent with Russian Law to submit tax or expropriation disputes to arbitration</i>	91
	(d) <i>It is inconsistent with Russian laws for shareholders to bring a claim in connection with damage caused to the company</i>	119
D.	HVY's other – previously rejected or entirely new – arguments cannot succeed	125
	(a) <i>Introduction</i>	125
	(b) <i>The majority of the arguments of HVY cannot be discussed in these proceedings</i> ...	126
	(c) <i>The District Court and the Tribunal correctly ruled that a reliance on Article 45(1) ECT does not require a prior declaration pursuant to Article 45(2) ECT</i>	138
	(d) <i>HVY's previously rejected reliance on acquiescence and estoppel is untenable</i>	149

UNOFFICIAL TRANSLATION

This text is an unofficial translation of the Dutch original. In case of any discrepancies, the Dutch original shall prevail.

(e)	<i>The District Court correctly ruled that the pacta sunt servanda principle is not violated (ground 5.19)</i>	177
(f)	<i>HVY's interpretation of the words "not inconsistent" is untenable (new argument)</i>	181
(g)	<i>HVY's arguments regarding the broad powers of President Yeltsin fail (new argument)</i>	188
E.	Discussion of the separate grounds for appeal and statements.....	219
(a)	<i>Introduction</i>	219
(b)	<i>Ground for Appeal 1: the final conclusions and operative part of the Judgment</i>	220
(c)	<i>Ground for appeal 2.1: submitted documents</i>	220
(d)	<i>Ground for appeal 2.2: the burden of proof rests on HVY</i>	224
(e)	<i>Ground for Appeal 2.3: the viewpoint of investors</i>	232
(f)	<i>Ground for appeal 3: the reliance on acquiescence and estoppel</i>	233
(g)	<i>Ground for appeal 4: the interpretation of Article 45 ECT</i>	234
(h)	<i>Ground for appeal 5: inconsistency with Russian constitutional law</i>	238
(i)	<i>Ground for appeal 6: inconsistency with the statutory provision on arbitrability</i>	243
(j)	<i>Defence against HVY's expert opinions</i>	244
III.	BACKGROUND: THE UNLAWFUL ACQUISITION, EXPLOITATION, AND LOOTING OF YUKOS OIL COMPANY.....	247
A.	Introduction.....	248
B.	The unlawful conduct of the Russian Oligarchs and HVY.....	253
(a)	<i>Phase 1 - The Russian Oligarchs Obtained HVY's Yukos Shares by Fraud, Bribery and Collusion: Bribes Were Paid by YUL</i>	254
(b)	<i>Phase 2 - The Russian Oligarchs created Hulley, YUL and VPL to conceal control over Yukos Shares and Evade Dividend Taxes</i>	266
(c)	<i>Phase 3 - The Russian Oligarchs Abused Shell Companies to Commit Tax Fraud in the Russian Federation's Low-Tax Regions (1996-2004)</i>	278
(d)	<i>Phase 4 - The Russian Oligarchs Obstructed Tax Enforcement, While Simultaneously Stripping Billions of Dollars from Yukos Through HVY</i>	291
C.	The Russian Oligarchs' Continuous Deception Regarding Their Ownership and Control of HVY.....	296
(a)	<i>1996-2002 - The Russian Oligarchs Concealed Their Ownership of Yukos</i>	297
(b)	<i>2006-2016 - The Russian Oligarchs Revealed Their Beneficial Ownership of GML and HVY, But Falsely Concealed Their Continuous Control of GML and HVY</i>	301
D.	Conclusion.....	313
IV.	GROUND FOR SETTING ASIDE 1 (CONTINUED) - NO VALID ARBITRATION AGREEMENT (ARTICLE 1065(1)(A) DCCP).....	314
A.	Introduction.....	314
B.	Legal Framework.....	315
C.	Jurisdictional Ground 2 – The Tribunal lacked jurisdiction because the ECT does not protect HVY nor HVY's shares in Yukos.....	315

UNOFFICIAL TRANSLATION

This text is an unofficial translation of the Dutch original. In case of any discrepancies, the Dutch original shall prevail.

(a)	<i>Introduction</i>	317
(b)	<i>The ECT Does Not Protect HVY's Yukos Shares Because They Are, At Bottom, Investments By Russian Nationals In Russia</i>	318
(c)	<i>The ECT Does Not Protect HVY's Investments Because They Were Made In Violation Of Law</i>	358
(d)	<i>Conclusion: the Tribunal lacked jurisdiction because HVY and their shares in Yukos are not protected under the ECT</i>	385
D.	Jurisdiction Ground 3 - The Arbitral Tribunal had no jurisdiction pursuant to Article 21 ECT.....	385
(a)	<i>Introduction</i>	387
(b)	<i>The carve-out of Article 21(1) ECT excludes arbitration pursuant to Article 26 ECT on taxation measures</i>	389
(c)	<i>The term "taxation measures" in Article 21(1) ECT includes any legislative, executive and collecting measure</i>	391
(d)	<i>The term "taxes" does not include executive measures and collecting measures</i>	393
(e)	<i>The contested measures of the Russian Federation are taxation measures but not taxes</i>	397
(f)	<i>The carve-out of Article 21(1) ECT applies to any taxation measures that is sufficiently clearly connected with a taxation law or regulation</i>	398
(g)	<i>Even on the basis of the incorrect standard applied by the Tribunal, the taxation measures of the Russian Federation are subject to the carve-out of Article 21(1) ECT</i>	401
(h)	<i>The ECtHR judgments in 2011 and 2013 confirm that the measures of the Russian Federation concerned a legitimate exercise of the Russian Federation's power to levy taxes</i>	404
(i)	<i>The measures of the Russian Federation are consistent with internationally recognised tax policies and practices, including those of the Netherlands</i>	406
(j)	<i>Conclusion: on the basis of Article 21 ECT, the Tribunal had no jurisdiction in respect of HVY's claims</i>	407
V.	GROUNDS FOR SETTING ASIDE 2 AND 3 - NON-COMPLIANCE WITH THE MANDATE OF THE ARBITRAL TRIBUNAL AND THE COMPOSITION OF THE ARBITRAL TRIBUNAL (ARTICLE 1065(1)(C) AND (B) DCCP).....	409
A.	<i>Introduction</i>	409
B.	<i>Legal framework</i>	409
C.	Mandate Ground 1 - The Tribunal has failed to refer the expropriation dispute to the competent tax authorities	410
(a)	<i>Introduction</i>	412
(b)	<i>The provisions of Article 21(5) ECT</i>	412
(c)	<i>History, object and scope of Article 21(5) ECT</i>	413
(d)	<i>Course of proceedings and Tribunal's decision</i>	414
(e)	<i>Fallacies of the Tribunal; HVY's arguments cut no ice</i>	417
(f)	<i>Consequences for crucial parts of the Final Awards</i>	421

UNOFFICIAL TRANSLATION

This text is an unofficial translation of the Dutch original. In case of any discrepancies, the Dutch original shall prevail.

(g)	<i>Conclusion: the Tribunal has not complied with its mandate and acted in violation of public order by consciously ignoring Article 21(5) ECT.....</i>	422
D.	Mandate Ground 2 – The Tribunal violated its mandate by not allowing the Russian Federation an opportunity to set out its position on the Tribunal's own method for calculation damages.....	422
(a)	<i>Introduction.....</i>	424
(b)	<i>The debate between the parties and the Tribunal's conclusions.....</i>	428
(c)	<i>The Tribunal's own methodology.....</i>	432
(d)	<i>The valuation dates were determined in violation of Article 13 ECT.....</i>	440
(e)	<i>The Tribunal's use of its own methodology without hearing both parties had substantial consequences.....</i>	441
(f)	<i>Conclusion: the determination of the damage was an inadmissible surprise decision.....</i>	450
E.	Mandate Ground 3 – The Tribunal did not personally fulfil its mandate and consequently the Tribunal was incorrectly composited (Article 1065(1)(c) and (b) DCCP).....	450
(a)	<i>Introduction and overview of delegation reproach.....</i>	452
(b)	<i>The prohibition on delegation of the 'substantive' arbitral task.....</i>	467
(c)	<i>The scientific evidence that Valasek has written essential components of the Final Awards.....</i>	498
(d)	<i>Conclusion: the Arbitrators have, by delegating part of their task to their assistant, violated their mandate and/or fulfilled it with a 'fourth arbitrator'.....</i>	506
VI.	GROUND FOR SETTING ASIDE 4 - AWARDS ARE NOT ADEQUATELY REASONED.....	507
A.	Introduction.....	507
B.	Legal Framework.....	508
C.	Reasoning Ground 1 - The Tribunal failed to state sound reasons for its essential opinions in respect of estimating the amount of the damages.....	511
(a)	<i>Introduction.....</i>	512
(b)	<i>Flawed reasoning.....</i>	513
(c)	<i>Conclusion: the estimate of the amount of the damages by the Tribunal lacks (sound) reasons.....</i>	521
D.	Reasoning Ground 2 - The Arbitral Tribunal has not stated any sound reasons for its incorrect opinion that the case file does not contain evidence showing that the Mordovian companies of Yukos were sham companies, incorporated solely for the purpose of avoiding Russian taxes.....	521
(a)	<i>Introduction:.....</i>	523
(b)	<i>There is an abundance of evidence of the fraud Yukos committed in Mordovia which is furthermore identical to the evidence of the fraud Yukos committed in Lesnoy and Trekhgornyy.....</i>	527
(c)	<i>The opinion of the Tribunal is incomprehensible and unsubstantiated.....</i>	538
(d)	<i>Conclusion: an abundance of evidence, no tenable reason.....</i>	540

UNOFFICIAL TRANSLATION

This text is an unofficial translation of the Dutch original. In case of any discrepancies, the Dutch original shall prevail.

E.	Reasoning Ground 3 - Several of the Tribunal's findings are based on its own speculations; no sound reasoning.....	541
	(a) <i>Introduction</i>	542
	(b) <i>Speculation in respect of reattributing revenues of Yukos' sham companies to Yukos itself</i>	544
	(c) <i>Speculation about fines imposed on Yukos</i>	548
	(d) <i>Speculation about VAT assessments imposed on Yukos</i>	548
	(e) <i>Speculations about Yukos' bankruptcy proceeding</i>	549
	(f) <i>Speculation about sub rosa direction from Russian Federation to Rosneft</i>	550
	(g) <i>Conclusion: speculations do not amount to sound reasoning</i>	551
F.	Reasoning Ground 4 - The Tribunal's finding regarding the YNG shares is internally inconsistent; the reasoning is not sound.....	551
	(a) <i>Introduction</i>	552
	(b) <i>The unsubstantiated finding of the Tribunal that the YNG shares were sold for a price far below their fair value contradicts its own valuation of Yukos as a whole</i>	553
	(c) <i>The opinion on the YNG auction supported the award of the expropriation claim in the Final Awards</i>	554
	(d) <i>Conclusion: unsound reasoning because of internally inconsistent conclusion with regard to the YNG auction</i>	555
VII.	GROUND FOR SETTING ASIDE 5 - THE YUKOS AWARDS ARE CONTRARY TO THE PUBLIC POLICY (ARTICLE 1065(1)(E) DCCP).....	556
	A. <i>Introduction</i>	556
	B. <i>Legal framework</i>	557
	C. <i>Public Policy Ground 1 - The Tribunal's violation of the right of both sides to be heard and the right to equality of arms</i>	559
	D. <i>Public Policy Ground 2 - The Tribunal has violated public policy by basing its award on speculation</i>	561
	E. <i>Public Policy Ground 3 - The Tribunal relied on its own views with regard to what Russian law should have provided rather than on what Russian law actually provided</i>	564
	F. <i>Public Policy Ground 4 - The Tribunal's finding regarding the YNG shares is internally inconsistent and is based on the Tribunal's own speculation</i>	566
	G. <i>Public Policy Ground 5 - HVY's Fraud in the Arbitration Requires Set-Aside of the Yukos Awards on Public Policy Grounds</i>	568
	H. <i>Public Policy Ground 6 - Enforcement of the Yukos Awards would violate Public Policy regarding Fraud, Corruption, and other Serious Illegality</i>	573
	I. <i>Conclusion: Yukos Awards are contrary to the public policy</i>	577
VIII.	REMAINING ISSUES.....	578
	A. <i>Defence against several irrelevant biased allegations in the introduction of the Statement of Appeal</i>	578
	(a) <i>Allegations regarding the judiciary in Armenia</i>	579

UNOFFICIAL TRANSLATION

This text is an unofficial translation of the Dutch original. In case of any discrepancies, the Dutch original shall prevail.

(b)	<i>Allegations with regard to Mr. Aleksanyan and the alleged manipulation of witnesses</i>	581
(c)	<i>Allegations on purported inappropriate diplomatic pressure</i>	584
(d)	<i>Allegations relating to alleged mass propaganda</i>	587
(e)	<i>Allegations on purported disingenuous statements</i>	590
IX.	EXHIBITS, OFFER OF PROOF AND CONCLUSION	591
A.	Exhibits and Offer of Proof.....	591
B.	Conclusion	593
X.	ANNEX 1 - QUOTES FROM EVIDENCE ALREADY SUBMITTED IN THE ARBITRATIONS CONCERNING YUKOS' SHAM COMPANIES IN LOW-TAX REGIONS, INCLUDING MORDOVIA	595
XI.	LIST OF DEFINED TERMS	613
XII.	LIST OF (LEGAL) AUTHORITIES (SECONDARY)	628
XIII.	OVERVIEW OF EXPERT REPORTS AND WITNESS STATEMENTS	640
A.	Overview of expert reports Defence on Appeal [without annexes].....	640
B.	Overview of witness statements Defence on Appeal [without annexes]	640
C.	Overview of expert reports in First Instance and Defence on Appeal [with annexes].....	641
D.	Overview of witness statements in First Instance and Defence on Appeal [with annexes] ..	674
XIV.	OVERVIEW OF EXHIBITS	684

I. INTRODUCTION

A. Structure of this Defence on Appeal

1. In its judgment of 20 April 2016, the District Court in The Hague ("**District Court**") set aside the Yukos Awards on account of the lack of a valid arbitration agreement within the meaning of Article 1065(1)(a) DCCP ("**Judgment**").¹ HVY has put forward grounds for appeal against this judgment. In this Defence on Appeal, these grounds for appeal will first be addressed.
2. The Tribunal deemed itself competent because according to the Tribunal Article 26 of the Energy Charter Treaty ("**ECT**" or "**Treaty**") entailed an offer from the Russian Federation to submit the dispute of HVY with the Russian Federation to arbitrators. The District Court rightly held that the Russian Federation is not bound by the arbitration clause of Article 26 ECT in relation to this dispute, since the Russian Federation never ratified the ECT. Nor did the ECT enter into force from the Russian Federation's point of view. As a Signatory, the Russian Federation only undertook to provisionally apply the ECT *to the extent* that provisional application is not inconsistent with its national law. The District Court ruled that arbitration is inconsistent with Russian law, *inter alia* because public-law disputes according to Russian law are not arbitrable. The consequence is that the Russian Federation never agreed to arbitration. The Russian Federation will explain that the District Court's conclusion is correct and will also demonstrate that HVY's grounds for appeal against the Judgment are unfounded. The Judgment of the District Court must be upheld.
3. Subsequently the factual background of the dispute will be discussed. These are important for the various grounds for setting aside and will be described in an continuous story for the sake of clarity.
4. In the following chapters, the Russian Federation will discuss the grounds for setting aside that were advanced in the first instance. The Court of Appeal can, but is not obliged to, confine itself to hearing the Appellant's grounds for appeal. It may also, either immediately or in addition or instead, hear and rule on the respondent's other grounds of action still

¹ Meanwhile, the District Court in Brussels has expressly recognised the correctness and validity of the Judgment. According to the District Court in Brussels the fact that the Judgment was not irrevocable yet did not stand in the way of this. See District Court Brussels 8 June 2017 (**Exhibit RF-296**).

remaining as a result of the devolutive effect of the appeal proceedings.² In the unlikely event that this Court of Appeal first addresses HVY's grounds for appeal and is of the opinion that the provisional application of the ECT does not stand in the way of the Tribunal's jurisdiction, the other grounds for setting aside will be discussed again on the basis of the devolutive effect of the appeal. In addition, HVY's arguments advanced in its Statement of Rejoinder and Pleading Notes, which have not yet been contested in writing, will be discussed. Naturally, this does not alter the fact that everything the Russian Federation has argued in the first instance must be included in the context of the devolutive effect.

5. The Defence on Appeal will be concluded with, *inter alia*, an Offer of Proof, the Conclusion, a List of Defined Terms, a List of Sources, a List of Expert Opinions and a List of Exhibits.
6. The Russian Federation maintains everything it stated in the first instance and adds new evidence in this appeal. Insofar as necessary, it refers to the offers of evidence made in the first instance and in this Defence on Appeal.

B. Anticipation of the legal framework under Article 1065(1)(a) DCCP

7. Based on Dutch procedural law, HVY bears the burden to demonstrate that there is a valid arbitration agreement. If HVY cannot provide this incontrovertible evidence and doubts remain, the Yukos Awards must be set aside on account of the lack of a valid arbitration agreement. The fact that HVY were defendants in the first instance does not alter this. HVY were claimants in the Arbitrations and had to prove the existence of the arbitration agreement. That position does not change in these Setting Aside Proceedings.
8. Another procedural rule is that HVY's grounds for appeal that are in conflict with what the *Tribunal* has ruled cannot succeed. HVY cannot attack rulings of the Tribunal that are displeasing to them, because only positive rulings on jurisdiction can be addressed in setting aside proceedings. After all, this Court of Appeal may only assess whether the Tribunal has assumed jurisdiction on the correct grounds. Jurisdictional grounds rejected by the Tribunal cannot be reconsidered. Nor can this Court of Appeal put a different ground for jurisdiction under the arbitral award. The legal system does not offer room for

² See, *inter alia*, Bakels et al., *Asser Procesrecht 4, Hoger beroep*, no. 134. See also *Snijders/Wendels, Civiel appel*, no. 218.

this. The court can only assess and then reject or allow the claim for setting aside. This is different than in the chain District Court - Court of Appeal - Supreme Court, where the judgment or ruling can be adjusted by a higher instance in a variety of ways.

C. Summary of the main arguments Article 45 ECT (Jurisdiction Ground 1)

9. It has not been contested that the ECT never entered into force for the Russian Federation. After all, the Russian Federation never ratified or approved the ECT. It was merely a Signatory and was not a Contracting Party. For a Signatory the ECT is possibly *provisionally* applicable. The scope of the provisional application is explicitly limited pursuant to Article 45 ECT and depends on the Signatory's national law: *“to the extent that such provisional application is not inconsistent with its constitution, laws or regulations.”*
10. The Russian Federation never agreed to provisionally apply Article 26 ECT. The District Court correctly followed this position and correctly held in accordance with the rules of interpretation for treaties of Article 31 VCLT that the only correct interpretation of Article 45(1) ECT is that the Russian Federation *“was only bound by the treaty provisions reconcilable with Russian law”*.
11. The District Court rightly held that arbitration about this dispute on the basis of Article 26 ECT is inconsistent with the Russian constitution, laws or regulations: In this context the District Court held that the provisional application of Article 26 ECT is inconsistent with the principle of the separation of powers laid down in the Russian constitution. Moreover, arbitration is contrary to Russian law because tax and expropriation disputes under Russian law cannot be settled by arbitration.
12. HVY and the experts they engaged have not advanced any material based on which the District Court's conclusion can be disproved. Instead, HVY elaborately discuss (i) arguments already expressly dismissed by the Tribunal and (ii) newly conceived arguments. Such arguments – which needlessly complicate matters – cannot be addressed in these setting aside proceedings.

D. The backgrounds; known and new facts and evidence

13. The chapter about the backgrounds discusses issues including the illegal acquisition of the Yukos shares (the “Investment”) in the Russian Federation in 1995 and 1996 by Russian Oligarchs (the Russian nationals who created, own, and control HVY) through deceit,

collusion, the concealing of identities, bribery of the Red Directors, and other violations of the law; the recognised status of HVY as sham companies without any activities in the country of incorporation or elsewhere; the use of HVY by the Russian Oligarchs for a wide spectrum of illicit purposes, including to pay hundreds of millions of dollars in bribes to the Red Directors through sham contracts concluded by YUL, to channel the Oligarch's ill-gotten riches (including the illegally-obtained Yukos shares and illegal profits) out of the Russian Federation, to evade taxes on a large scale; and the continuous control of the Oligarchs over HVY and all group companies in the web of the Yukos group up to the trustees in the trusts that never had a say in the matter, as new evidence has demonstrated beyond doubt.

14. It also discusses how Yukos evaded taxes on an unprecedented scale under the Russian Oligarch's management, as confirmed by the ECtHR in two decisions of 2011 and 2013. Furthermore, it discusses how, via RTT (the secret in-house trust office of the Russian Oligarchs), the Russian Oligarchs maintained the web of companies, shifted it, had it disappear and controlled by straw men to conceal their illegal practices from the Russian Government (including the tax department) and the minority shareholders. A lot of new evidence has since come to light because the auxiliary persons of the Russian Oligarchs, such as Mr. Godfrey and Mr. Feldman, are now conducting proceedings against each other, as a result of which the true history has slowly been revealed. The witness statements are revealing and it has been established at this time that HVY have made false statements in the Arbitrations and had false statements made on their behalf. They therefore knowingly used false statements. This continued even before the District Court and even now before this Court of Appeal, as the Russian Federation demonstrates in this Defence on Appeal.

E. The other grounds for setting aside

15. As stated above, this Court of Appeal may also, either immediately or in addition or instead, hear and rule on the respondent's other grounds of action still remaining as a result of the devolutive effect of the appeal proceedings. In the unlikely event that this Court of Appeal first addresses HVY's grounds for appeal and finds that the District Court wrongly set aside the Yukos Awards on the basis of its interpretation of Article 45 ECT and the consequence lack of jurisdiction of the Tribunal, the below grounds for setting aside will be discussed again on the basis of the devolutive effect of the appeal proceedings.

(a) ***HVY are not Investors and have not made an Investment within the meaning of Article 1(6) and (7) ECT (Jurisdiction Ground 2)***

16. The Tribunal wrongfully applied both Article 1(6) ECT and Article 1(7) ECT, as the ECT does not apply to HVY because they are not “Investors”, nor does it apply to their shares in Yukos because they do not qualify as an “Investment” within the meaning of the ECT.
17. The Tribunal wrongly held that HVY are “Investors” – a view wrongly formed, in part, because HVY withheld evidence and made numerous misrepresentations concerning their identities. Since the Russian Oligarchs have full control over HVY and the full economic ownership of their Yukos shares, it is therefore a dispute between Russians and the Russian Federation. That is a U-roundtrip, i.e. an A-B-A dispute. The ECT provides no protection for disputes of a national against its own State. The ECT only protects foreign investors, which does not include the Russian Oligarchs controlling HVY.
18. The Tribunal also wrongly held that there was an "Investment" even though HVY did not invest any foreign capital in the Russian Federation. HVY obtained the Yukos shares through a web of related-party transactions involving shell companies all owned and controlled by the Russian Oligarchs. HVY never made any economic contribution to the Russian Federation, and indeed were used by the Oligarchs to unlawfully channel billions of dollars *out* of the Russian Federation. It furthermore follows from international law, but also from rules of Dutch public policy, that an Investment that was obtained illegally is never protected.
19. Since there was not any valid agreement to arbitrate with Russian nationals – fake foreign investors – over reinvested laundered funds – fake investments – the Yukos Awards must be set aside pursuant to Article 1065(1)(a) DCCP.

(b) ***HVY's claims concern allegedly unlawful taxation measures and not taxes, and therefore fall outside the scope of the ECT pursuant to Article 21 ECT (Jurisdiction Ground 3)***

20. The Tribunal wrongly assumed jurisdiction for HVY's claims with regard to the Russian Federation's taxation measures. The measures of the Russian Federation, which have been contested by HVY, qualify as taxation measures within the meaning of Article 21(1) ECT. Under the carve-out of Article 21(1) ECT, such measures fall outside the scope of the ECT and thus also outside the scope of the arbitration clause in Article 26 ECT. These “carved out” taxation measures of the Russian Federation are not brought back within the scope of

the ECT by the “claw-back” for expropriating taxes included in Article 21(5), because the concept of “taxes” in Article 21(5) does not include enforcement and collection measures. As HVY complain about the Russian Federation's enforcement and collection measures, the claw-back of Article 21(5) ECT does not apply.

21. Since there was no valid arbitration agreement, the Yukos Awards must be set aside pursuant to Article 1065(1)(a) DCCP.

(c) ***Failure to comply with the mandate***

22. The Tribunal failed to comply with its mandate on several points, which violations, either jointly or separately, must lead to the setting aside of the Yukos Awards pursuant to Article 1065(1)(c) DCCP.
23. First, the Tribunal, in violation of the mandatory instruction of Article 21(5) ECT, refused to submit the tax disputes to the competent tax authorities referred to in that Article.
24. Second, the Tribunal applied its own, novel, unexpected and unforeseeable methodology when calculating Yukos' equity value and the dividends allegedly lost by HVY. Both the valuation dates and the calculation methods were not known to the parties and did not follow from what was on the table. Since the Tribunal did not allow the parties to express their opinion before applying its own method, the determination of the damages qualifies as an inadmissible surprise decision. This is also contrary to public policy.
25. Third, it turns out a “fourth arbitrator”, Mr. Valasek, who had been presented as the “assistant” of chairman Fortier, has not acted as such and was involved with the substantive decision-making process of this case. Mr. Valasek spent a disproportionately large number of hours on the Final Awards in relation to the arbitrators themselves and the two secretaries (for which he charged almost one million Euros). This shows that Mr. Valasek made a contribution of a legally unauthorised size to the contents of the Final Awards. This legally unauthorised contribution is also reflected in independent studies by two linguistic experts. These studies show that it is more than 95% certain that Mr. Valasek alone wrote half or more of three chapters crucial to the outcome of the Arbitrations. The arbitrators must perform their task personally and not leave it to an assistant. Moreover, the Tribunal was not properly constituted because of this legally unauthorised contribution by Mr. Valasek, a “fourth” arbitrator. The Yukos Awards should be set aside for this reason as well, pursuant to Article 1065(1)(b) and (c) DCCP.

(d) *Violation of the duty to state reasons*

26. Moreover, the Tribunal also violated its duty to state reasons in various crucial decisions, which violations, either jointly or separately, must lead to the setting aside of the Yukos Awards pursuant to Article 1065(1)(d) DCCP
27. First, in determining the damages, the Tribunal failed to provide a well-founded justification for its self-conceived loss calculation methodology because it based this partly on grounds it rejected itself.
28. Second, the Tribunal ruled, completely incomprehensibly, that there was "*not any evidence*" that the Mordovian entities were sham companies. In the Arbitrations, however, an abundance of evidence was submitted of the sham character of the quasi-independent "trading partners" formally established in Mordovia but managed entirely from Moscow by Yukos, whereas, on the basis of identical evidence, the Tribunal furthermore ruled that fraud had been committed with the sham companies in Lesnoy and Trekhgorny. The Tribunal furthermore disregarded the ECtHR, which ruled on the basis of the evidence that had also been submitted to the Tribunal that all trading companies, including those in Mordovia, were sham companies and that the tax assessments imposed as a result were justified. Based on its incomprehensible finding, the Tribunal ruled (i) that the Russian Federation did not intend to collect taxes but intended to bring about Yukos' bankruptcy, (ii) there was expropriation under Article 13 ECT and (iii) the carve out of Article 21(1) ECT did not apply.
29. Third, the Tribunal speculated on what the Russian Federation might have done, instead of assessing what the Russian Federation *actually* did. At different instances decisive for its decisions, the Tribunal concluded that even if Yukos had acted in accordance with the law, the Russian Federation would have found another improper ground for imposing fines and letting Yukos go bankrupt.
30. Fourth, the Tribunal's opinion that the shares in YNG, which operated Yukos' largest production facility, were sold for a price "*far below*" their fair value is contrary to the Tribunal's own valuation of Yukos as a whole. The realised value for the YNG shares was in fact USD 300 million higher than the fair value of YNG calculated by the Tribunal.

(e) *Contrary to public policy*

31. Finally, the Yukos Awards should be set aside on each of the following grounds for being contrary to public policy pursuant to Article 1065(1)(e) DCCP.
32. The Tribunal violated the right of both parties to be heard and equality of arms by rendering an impermissible surprise decision on the calculation of the damages and by disregarding the mandatory obligation to refer the issue to the competent tax authorities pursuant to Article 21(5) ECT.
33. In addition, the Tribunal based considerations underlying its decisions (i) on its own speculations about what the Russian Federation might have done rather than what it actually did, (ii) on its own views on what Russian law should have provided rather than on what Russian law actually entails, and (iii) on its own speculation that the YNG auction was manipulated because the YNG shares were sold for a price “*far below*” their fair value.
34. Lastly, the contents of the Yukos Awards violate fundamental mandatory rules of Dutch law. In the present case, HVY, the Russian Oligarchs and Yukos (the latter two are rightly mentioned by the Tribunal in many places in the Yukos Awards in one breath with HVY) have committed extensive fraud, collusion, bribery and money laundering since the beginning of the acquisition of the shares in Yukos, and continued to do so thereafter until the present proceedings. In various places, the Tribunal turned a blind eye to this or used incomprehensible reasoning to circumvent this. The result of the Yukos Awards – rewarding HVY and therefore the Russian Oligarchs, who are the actors in the process of illegal acts and who falsely obtained the Yukos Awards through HVY – is contrary to fundamental values and standards of both Dutch and international law. The Dutch court must prevent this serious violation of public policy by setting aside the Yukos Awards.

II. GROUND FOR SETTING ASIDE 1 - NO VALID ARBITRATION AGREEMENT (ARTICLE 1065(1)(A) DCCP)

Essence of the reasoning

The Russian Federation did not consent to the arbitration scheme of Article 26 of the Energy Charter Treaty (“ECT”, the “Treaty”), While the Russian Federation did sign the Treaty, it never ratified it. Accordingly, the Treaty never entered into force for the Russian Federation (section II.B(a)).

Nor did the Russian Federation consent to the provisional application of Article 26 ECT on the basis of Article 45 ECT.

- The provisional application under Article 45 ECT is restricted, namely “*to the extent that such provisional application is not inconsistent with its constitution, laws or regulation*”. The District Court rightly concluded that the Russian Federation “*was only bound by the Treaty Provisions that are consistent with Russian law*” (section II.B).
- Arbitration of this dispute on the basis of Article 26 ECT is inconsistent with the Russian constitution, laws and regulations (section II.C):

The District Court correctly ruled that the provisional application of Article 26 ECT is inconsistent with the principle of the separation of powers laid down in the Russian constitution (section II.C(b));

The District Court correctly ruled that arbitration is inconsistent with Russian laws because tax and expropriation disputes are not arbitrable (section II.C(c)).

It is inconsistent with Russian laws for shareholders to bring their own claims in connection with damage caused to the company (section II.C(d)).

HVY’s Statement of Appeal primarily pertains to (i) already explicitly rejected arguments by the Tribunal and (ii) newly devised arguments. Those parts of the Statement of Appeal make this case needlessly complicated. They are irrelevant to the assessment of this dispute. The arguments and grounds for appeal of HVY that should not already be disregarded on procedural grounds should in any event be rejected on substantive grounds (section II.D, II.E).

A. Introduction

35. A State's consent to arbitration must be clear, unambiguous and voluntary.³ The key question in these proceedings is whether such clear and unambiguous consent by the Russian Federation can be derived from the arbitration clause of Article 26 of the ECT.
36. A government representative of the Russian Government signed the ECT. However, the Treaty was never approved or ratified by the Russian Parliament.⁴ Consequently, the Russian Federation merely qualifies as a Signatory, not as a Contracting Party.⁵ The Treaty did not enter into force for the Russian Federation.⁶ The Russian Federation has only applied the Treaty provisionally. The scope of the provisional application of the Treaty was explicitly limited in the Treaty itself.
37. In this case, the District Court in The Hague ruled that the Russian Federation did not consent to arbitration under the terms of Article 26 ECT. That Judgment of the Court is the key element in these appeal proceedings. HVY's Statement of Appeal raises numerous new

³ Compare in this context Article 1020 of the Dutch Code of Civil Procedure ("DCCP"). See also Snijders 2011, Article 1020 DCCP annotation 1: "*In light of Article 6 ECHR and Article 17 of the Constitution, the choice for arbitration must be unambiguous and voluntary for it to be legally valid. A concrete arbitration must therefore be based on an agreement between the parties that is aimed at arbitration. This requirement can also be found in Articles 1020 and 1065(1)(a) DCCP.*" The International Court of Justice held in *Bosnia-Herzegovina v Yugoslavia*, ICJ Order of 13 September 1993 (R-199), § 34 (<http://www.icj-cij.org/docket/files/91/7311.pdf>) that there must be an "*unequivocal indication*" of a "*voluntary and indisputable*" consent. See also the NAFTA case *Fireman's Fund v. Mexico*, ICSID Case No. ARB(AF)/02/01, Decision on the preliminary question, 17 July 2003, § 64 (http://www.italaw.com/sites/default/files/case-documents/ita0330_0.pdf) "*[a claimant] is not entitled to the benefit of the doubt with respect to the existence and scope of an arbitration agreement.*" See also *Plama Consortium Limited v. Republic of Bulgaria*, ICSID Case No. ARB/03/24, Decision on Jurisdiction, 8 February 2005, § 198 (RME-1007; **Exhibit RF-03.2.C-2.1007**) ("*an agreement [to arbitrate] should be clear and unambiguous.*"); *Daimler Financial Services AG v. Argentine Republic*, ICSID Case No. ARB/05/1, Award, 22 August 2012, § 175 (**Exhibit RF-81**): ("*it is not possible to presume that consent has been given by a state. Rather, the existence of consent must be established. (...) What is not permissible is to presume a state's consent by reason of the state's failure to proactively disavow the tribunal's jurisdiction. Non-consent is the default rule; consent is the exception.*"); see also *National Gas S.A.E. v. Arab Republic of Egypt*, ICSID Case No. ARB/11/7, Award, 3 April 2014, § 117 (**Exhibit RF-73**) "*Consent always is the essential condition precedent to arbitration and, indeed, to any form of consensual adjudication*".

⁴ Article 12, 14(1)(a), Vienna Convention on the Law of Treaties (hereinafter "VCLT"). For brevity's sake, only "*approval*" or only "*ratification*" will be referred to below, instead of "*approval or ratification*".

⁵ See the definition of Contracting Party, as included in the Treaty and cited by the District Court in ground 3.1 of the Judgment. The Russian Federation does not qualify as a "*Contracting State*". In 55 paragraphs of their Statement of Defence, HVY have mixed up the terms of Contracting State and Signatory at least 123 times (see SoR, §§ 48 and 55). HVY alleged that the Russian Federation is a Contracting State. This is incorrect, which they seem to have acknowledged in SoRej., footnote 34.

⁶ Judgment, ground 5.72. See also Article 39 ECT.

topics for the first time in years. This is confusing, and it needlessly complicates the case by diverting attention away from the points that are legally relevant. The core of the Judgment – which is up for assessment in the appeal proceedings – can be summarized as follows:

Introduction (ground 5.4)

The District Court states first and foremost that, according to established case law, the claim for setting aside an arbitral award on the ground that a valid arbitration agreement is lacking must not be reviewed with restraint. The District Court rules that the burden of proof of the existence of a valid arbitration agreement is on HVY.

Article 45 ECT (grounds 5.6-5.31)

The District Court recalls that the Russian Federation did not ratify the ECT. Articles 39 and 44 ECT make it clear that the entry into force of the Treaty is subject to ratification.⁷

"Article 39. Ratification, acceptance or approval

This Treaty shall be subject to ratification, acceptance or approval by signatories. Instruments of ratification, acceptance or approval shall be deposited with the Depositary.

Article 44, entry into force

For each state (...) which ratifies, accepts, or approves this Treaty or accedes thereto (...)it shall enter into force on the ninetieth day after the date (...) by such state (...) of its instrument of ratification, acceptance, approval or accession. (...)"⁸

The District Court subsequently discusses the provisional application of the Treaty in detail.⁹ The scope of the provisional application is explicitly limited. This follows from Article 45(1) ECT:

“Each signatory agrees to apply this Treaty provisionally pending its entry into force for such signatory in accordance with Article 44, to the extent that such provisional application is not

⁷ Judgment, ground 5.6.

⁸ The District Court cited these and other relevant provisions in ground 3 of the Judgment.

⁹ Judgment, grounds 5.7 et seq.

inconsistent with its constitution, laws or regulations." (emphasis added)

The District Court interprets Article 45 ECT in accordance with the rules laid down in Articles 31 and 32 Vienna Convention on the Law of Treaties 1969 ("VCLT").¹⁰ It discusses the meaning of the terms in Article 45 ECT, the context and the object and purpose of the Treaty in detail. It comes to the conclusion that the Russian Federation "*was only bound by the Treaty Provisions that are consistent with Russian law*".¹¹

The District Court did discuss the different arguments and objections of HVY in its assessment. For instance, it extensively reasoned why it rejected HVY's position that a reliance on Article 45(1) ECT required a prior declaration as included in Article 45(2) ECT.¹²

Article 26 ECT (grounds 5.32-5.94)

The District Court rules that the arbitration clause laid down in Article 26 ECT, from which the Tribunal derived its jurisdiction, is inconsistent with Russian law.¹³

To this end, the District Court considers, firstly, that HVY's claims relate to acts under public law (tax assessments, collection measures etc.). The District Court rules that Russian legislation does not allow disputes resulting from public-law legal relationships to be presented to arbitrators.¹⁴

Secondly, the District Court discusses the Russian Constitution in detail.¹⁵ It rules that the power to enter into treaty obligations that deviate from Russian laws is vested in the legislature. The District Court concludes that the Russian Constitution and the principle of the separation of powers laid down therein prevent a representative of the executive power from binding the Russian Federation to Article 26 ECT.

¹⁰ Judgment, ground 5.9.

¹¹ Judgment, ground 5.23.

¹² Judgment, grounds 5.24-5.31.

¹³ Judgment, grounds 5.32-5.65.

¹⁴ See in particular Judgment, grounds 5.36-5.41.

¹⁵ Judgment, grounds 5.67-5.94.

Final conclusion (grounds 5.95 et seq.)

The District Court comes to the conclusion that the Russian Federation never made an unconditional arbitration offer through the signing of the ECT:

“5.95. The findings in this judgment lead to the final conclusion that it follows from Article 45(1) ECT that the Russian Federation had not bound itself to the provisional application of (the arbitration regulations of) Article 26 ECT by the mere signature of the ECT. The Russian Federation consequently never made an unconditional offer for arbitration in the sense of Article 26 ECT. As a result, the defendants’ ‘notice of arbitration’ did not form a valid arbitration agreement.”

38. The District Court's decision will be discussed in detail in the following sections (see the schematic overview on the next page). As a preliminary matter, it will be set out that the ECT must be ratified for it to enter into force (see subchapter II.B of this Defence on Appeal). After all, the Treaty prescribes that States must express their consent to be bound by the Treaty through ratification. Subsequently, the interpretation of Article 45(1) ECT will be addressed. The Russian Federation will explain that the District Court correctly concluded that only treaty provisions that are consistent with Russian law must be applied provisionally (see §§ 63 et seq.). In addition, the Russian Federation will show that the District Court's interpretation is consistent with what the States had in mind during the negotiations on the ECT. The District Court's interpretation is fully consistent with the understanding of the Netherlands, the European Union and all of its current and/or former Member States, representatives of *inter alia* the United States, Finland and Japan, those who were involved in the negotiations regarding the ECT and the prevailing view in legal literature (see §§ 106 et seq.).
39. In subchapter II.C, it will be made clear that the District Court rightly ruled that arbitration of HVY's claims under Article 26 ECT is inconsistent with Russian law. In this context, the Russian Federation will (once again) elaborate three independent arguments, which can be briefly summarized as follows:
1. The District Court correctly ruled that it is contrary to the principle of the separation of powers laid down in the Russian Constitution and laws if the Russian government were to unilaterally accept the provisional application of Article 26 ECT on behalf of the Russian Federation (see §§ 141 et seq.). Indeed, treaties containing arbitration provisions, such as Article 26 ECT, need to be ratified.

UNOFFICIAL TRANSLATION

This text is an unofficial translation of the Dutch original. In case of any discrepancies, the Dutch original shall prevail.

2. HVY base their claims in the Arbitrations on the assertion that Russian tax assessments and collection measures constitute an unlawful expropriation. The District Court correctly ruled that it is inconsistent with Russian laws to arbitrate such (non-arbitrable) tax and expropriation disputes (see §§ 188 et seq.).
 3. HVY have instituted legal proceedings for a decrease in value or loss of their shares as a result of damage caused to the company Yukos. It is inconsistent with Russian laws to file such a “derivative” action (see §§ 242 et seq.).
40. Subchapter II.D and subchapter II.E will – lastly and for completeness’ sake – separately address the different arguments and grounds for appeal of HVY. Subchapter II.D will especially address the already rejected arguments by the Tribunal and entirely new arguments first raised by HVY after twelve years of litigation. These arguments are largely irrelevant to the assessment and should be disregarded on procedural grounds. Nevertheless, the Russian Federation will explain that these arguments should also be disregarded on substantive grounds. Subchapter II.E will address HVY’s grounds for appeal.

B. The District Court interpreted Article 45(1) ECT correctly

The Russian Federation refers to:		
<u>Arbitrations:</u>		
HEL Interim Award	Chapter VIII.A	marginal nos. 244-398
<u>Setting aside proceedings:</u>		
Writ	Chapter IV.C.b	§§ 133-186
SoD	Part I, Chapter 3.2.2	§§ 39-60
	Part II, Chapter 2.1.2	§§ 103-190
	Part II, Chapter 2.1.4	§§ 267-313
SoR	Chapter III.C.c	§§ 63-110
SoRej	Chapter 2.2	§§ 20-145
RF Pleading Notes	Chapter III	§§ 9-26
HVY Pleading Notes	Chapter 1.2.2	§§ 46-63
SoA	Part I, Chapter 4	§§ 228-413

Primary exhibits:	
<u>Arbitrations:</u>	
RF-352	Joint Statement by the EC, the Council and the Member States on the interpretation of Article 45 ECT
C-924	Report Charter Conference
RF-843	Interpretation Article 45 ECT, Japanese government
<u>Setting aside proceedings:</u>	
RF-27	Interpretation Article 45 ECT, R. Lefeber (VU)
RF-31	Interpretation Article 45 ECT, Finnish authorities
RF-38	Interpretation Article 45 ECT, Mr Bamberger
RF-249	Interpretation 45 ECT, fax Lise Weis
RF-272	Interpretation 45 ECT, fax Lise Weis
RF-239-RF-246	Documents concerning establishment of Russian text of Article 45 ECT

RF-D1 annexes HER-1-HER-5
RF-D3Interpretation Article 45 ECT by Dutch authorities
Pellet Expert Opinion**Essence of the reasoning**

The District Court interpreted Article 45(1) ECT correctly.

- While the Russian Federation did sign the Treaty, it never ratified it. It is not a Contracting Party. The Treaty never entered into force for the Russian Federation (section (a)).
- Article 45(1) ECT entails that signatories apply the ECT provisionally only *“to the extent that such provisional application is not inconsistent with its constitution, laws or regulations.”* (section (b)).
- The words “to the extent” in Article 45(1) ECT make clear that signatories provisionally apply part of the Treaty. The District Court rightly concluded that the Russian Federation *“was only bound by the Treaty Provisions that are consistent with Russian law”* (section (c)).
- This interpretation by the District Court is generally accepted. It corresponds to the understanding of:
 - the Netherlands (section (d)(i));
 - the European Union and its then Member States (section (d)(ii));
 - the representatives of the United States, Italy, the United Kingdom, Finland and Japan (section (d)(iii));
 - the Russian Federation (section (d)(iv));
 - important advisers and negotiators involved in the conclusion of the ECT (section (d)(v));
 - the interpretation generally accepted in legal literature (section (d)(vi)).
- Moreover, the all-or-nothing interpretation advocated by HVY attaches to Article 41(1) ECT the absurd and unrealistic consequence that governments of countless States acted in violation of their own laws by signing the Treaty (section (e)).

(a) *The ECT’s entry into force requires ratification*

41. Different phases can be distinguished in the formation of a treaty. First of all, the text of a treaty is negotiated and established definitively. The treaty is then signed. However, the signing of a treaty generally does not mean that the treaty actually enters into force for the States involved. The entry into force of a treaty ordinarily requires the completion of another phase. In that phase, States express their consent to the treaty through ratification.¹⁶ Ratification of a treaty is required under international law if the treaty provides such (Article 14 VCLT).¹⁷

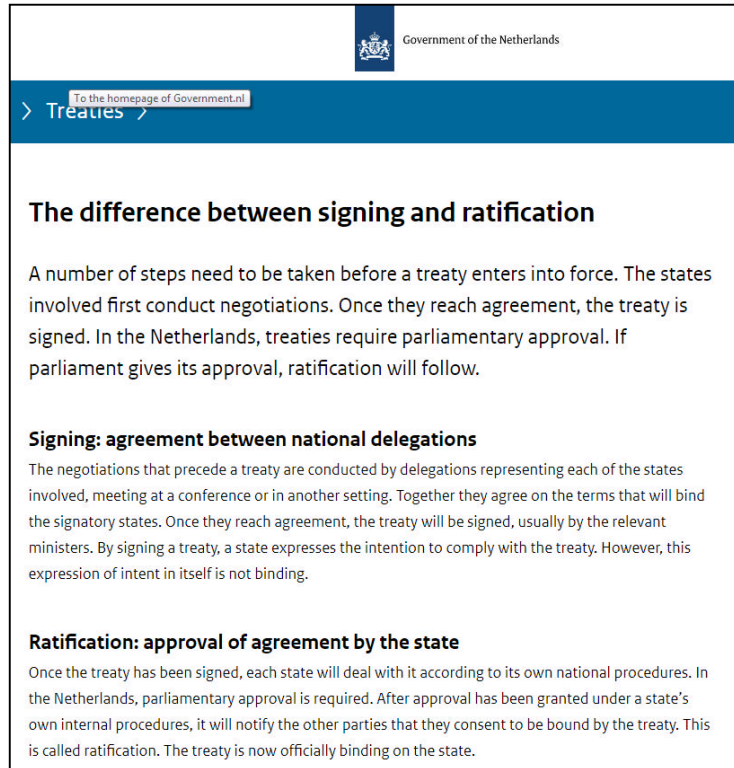

The screenshot shows a webpage from the Government of the Netherlands. At the top right is the logo and name 'Government of the Netherlands'. Below that is a blue navigation bar with the text '> Treaties >'. The main content area has a white background with a blue header for the article title: 'The difference between signing and ratification'. The text explains that a number of steps are needed before a treaty enters into force, starting with negotiations and signing. In the Netherlands, treaties require parliamentary approval. It then defines 'Signing: agreement between national delegations' as negotiations conducted by delegations representing each state, where they agree on terms to bind the signatory states. Finally, it defines 'Ratification: approval of agreement by the state' as the process where each state deals with the treaty according to its own national procedures, with parliamentary approval required in the Netherlands.

42. The distinction between signature and ratification is key in this case. This basic distinction was clearly explained by the legislator at the time the VCLT was ratified.¹⁸ This distinction

¹⁶ This Defence on Appeal will use the terms "approval" and "ratification" without intending any further substantive distinction.

¹⁷ See also Article 6 of the Russian FLIT, Judgment, grounds 5.69, 5.71 and 5.72. Article 14(1) VCLT provides: "1. The consent of a State to be bound by a treaty is expressed by ratification when: a) the treaty provides for such consent to be expressed through ratification; (...)" See also René Lefeber: "If so provided, a treaty is thus not necessarily applied provisionally by all negotiating States, but only by those negotiating States that actually sign the treaty and by other signatories." Original English text: "If so provided, a treaty is thus not necessarily applied provisionally by all negotiating States, but only by those negotiating States that actually sign the treaty and by other signatories. Such signature is, of course, not 'signature' according to Art. 12 VCLT (consent to be bound by signature), but as meant in Art. 14(c) VCLT (consent to be bound by signature subject to ratification)." René Lefeber, Provisional Application, in Max Planck Encyclopedia Of Public International Law (2011), § 5, **Exhibit RF-101**. See SoR, § 53 and Judgment, grounds 5.69, 5.71 in which HVY's assertion that the Russian Federation consented to the Treaty under Article 12(1)(a) VCLT was refuted with reference to exhibits.

¹⁸ Explanatory Memorandum on Approval of the Vienna Convention on the Law of Treaties established in Vienna on 23 May 1969, with Annex, *Parliamentary Papers II*, 1982/83, 17798, 3, p. 7: "Different phases can be distinguished in the formation of a treaty. The first phase involves negotiating a (draft) text for a treaty and accepting the text. In general, the second phase that follows is the final adoption or authentication of the text of the treaty, possibly by the signing of the treaty. After this phase, the treaty is «concluded». However, this does not mean that the treaty has also entered into force; this requires a next

is also explained in an accessible manner in manuals and on websites. By way of example, see a page from the website of the Ministry of Foreign Affairs reproduced shows here.¹⁹

43. The requirement that a treaty must be ratified is closely related to the principle of the separation of powers. This principle implies that within a political system, the legislative, executive and judicial powers are separated. This principle has its origin in the philosophical ideas of *inter alia* John Locke and Charles de Montesquieu and is reflected in the constitution of most, if not all, European States. For example, the principle of the separation of powers was leading in the formation of the Dutch Constitution of 1848.²⁰
44. A corollary of the principle of the separation of powers is that the powers of the executive are limited. Accordingly, the Dutch government cannot unilaterally enact laws. The same applies with regard to the formation of treaties. The Kingdom of the Netherlands cannot be bound by treaties "*without the prior approval of the States General*".²¹ The premise that the Netherlands cannot be bound by treaties without the approval of the States General (i.e. Dutch Parliament) has been set out in more detail in the Treaties (Approval and Publication) Kingdom Act (*Rijkswet goedkeuring en bekendmaking verdragen*, hereinafter "**RGBV**").²² In other States, such as France, Finland, Austria, Germany and the Russian Federation, (legislative) treaties require parliamentary approval, too.²³

phase to be completed. This third and final phase is the consent of a State to be bound by the treaty and its entry into force for that State. (On the entry into force of multilateral treaties, a distinction must be made between the entry into force of the treaty itself and its entry into force for a particular state, which moments often do not coincide)."

¹⁹ Source: <https://www.government.nl/topics/treaties/contents/the-difference-between-signing-and-ratification> (last consulted in November 2017).

²⁰ The current Dutch Constitution still makes a clear distinction between the powers of the government, the States General (i.e. Dutch Parliament) and the judiciary. See chapters 2, 3 and 6 of the Dutch Constitution.

²¹ Article 91 of the Dutch Constitution. In a general sense, see: C.B. Modderman, 'De Staten-Generaal en de totstandkoming van verdragen' [The States General and the formation of treaties], *TvCR* 2015, pp. 34-60.

²² According to parliamentary history, that law has the purpose of achieving "*the greatest possible control of parliament*". *Parliamentary Papers II* 1988/89, 21214 (R 1375), 3, p. 2. The RGBV was recently amended in order to "*increase the democratic legitimacy of closing, amending and terminating treaties*." *Parliamentary Papers II*, 2014/15, 34158 (R 2048), 3, p. 1 (Explanatory Memorandum), Bulletin of Acts and Decrees 2017/210.

²³ See *inter alia* Professor A. Pellet Legal Opinion on the Provisional Application of a Treaty under French Constitutional Law (Taking the Example of the Energy Charter Treaty) (13 December 2006) ("**Professor Pellet's 2006 Expert Opinion**") (introduced in the Arbitrations, **Exhibit RF-03.1.C-1.3.9**), §§ 4-10; Professor Y. Nouvel, Expert Opinion (French Law) (18 March 2016), ("**Professor Nouvel's Expert Opinion**") (**Exhibit RF-D10**), §§ 33-38, M. Koskenniemi Expert Opinion on the Provisional Application of International Treaties in the Finnish Constitutional Law Context, Especially with Regard to the Energy

45. The approval of a treaty is not a formality. The requirement of approval is a protective construction under treaty law that serves to safeguard the separation of powers. Professor Reisman, the expert engaged by HVY, put it as follows:

“Ratification of treaties in republican systems such as that found in the United States is a critical bulwark of separation of powers and checks and balances. If the international legal system henceforth assigns legal validity to unratified treaties, that bulwark will be breached.”²⁴

46. A long process of negotiations preceded the adoption of the text of the ECT. The ECT was ultimately signed by government representatives of multiple States on 17 December 1994. Wijers, the Minister of Economic Affairs at the time, signed the Treaty on behalf of the Netherlands. Mr Davydov, the deputy prime minister of the Russian government, signed the Treaty on behalf of the Russian government. The signing was merely a phase in the potential formation of the Treaty. That the signing was required is evident from Article 38 ECT:

“Article 38. Signature

This Treaty shall be open for signature at Lisbon from 17 December 1994 to 16 June 1995 by the states and Regional Economic Integration Organizations which have signed the Charter.”

47. The mere signing is insufficient to express the consent of the States to be bound by the ECT as Contracting Parties. On the contrary, States signed the ECT subject to ratification.²⁵ This is also apparent from the text of the Treaty. Article 39 ECT explicitly provides that the ECT requires ratification, acceptance or approval:

“Article 39

Charter Treaty (27 October 2006) ("**Koskenniemi's Expert Opinion**") (introduced in the Arbitrations, **Exhibit RF-03.1.C-1.3.4**), §§ 4-10, Professor K. Talus, Expert Opinion dated 18 March 2016, ("**Professor Talus's Expert Opinion**") (**Exhibit RF-D11**), §§ 18-23, Professor G. Nolte Opinion Concerning Provisional Application of Article 26 of the Energy Charter Treaty from an International and German Constitutional Law Perspective (31 October 2006) ("**Professor Nolte's 2006 Expert Opinion**") (introduced in the Arbitrations, **Exhibit RF-03.1.C-1.3.7**), §§ 38-48 in addition to the opinion of Professor Nolte submitted in the arbitration, the Russian Federation submits a more up-to-date expert opinion of Professor Nolte dated 18 March 2016 ("**Professor Nolte's 2016 Expert Opinion**") (**Exhibit RF-D12**), §§ 24 et seq. G. Hafner, Legal Opinion (30 December 2006) ("**Hafner's Expert Opinion**") (introduced in the Arbitrations, **Exhibit RF-03.1.C-1.3.11**), §§ 15-17; with regards to Russian law, see §§ 165-170.

²⁴ Michael W. Reisman, *Unratified Treaties And Other Unperfected Acts In International Law: Constitutional Functions*, 35 Vanderbilt J. Transnat'l L. 729 (2002), 743 (R-258). See also SoR, § 57.

²⁵ See Article 14(1)(c) VCLT, footnote 17 above.

This Treaty shall be subject to ratification, acceptance or approval by signatories. Instruments of ratification, acceptance or approval shall be deposited with the Depositary.”

48. Entirely in line with the above, Article 42 ECT provides that amendments to the ECT also require ratification, acceptance or approval.²⁶ For the Netherlands, for example, this means that “*amendments to the Treaty itself always require the approval of the States General.*”²⁷
49. Article 44 ECT shows that the Treaty cannot enter into force for a State until after the State concerned ratifies the ECT.²⁸ Briefly put, Article 44 ECT provides the following:

“Article 44 paragraphs 1 and 2

1. This Treaty shall enter into force on the ninetieth day after the date of deposit of the thirtieth instrument of ratification, acceptance or approval thereof, or of accession thereto, by a state (...)

2. For each state (...) which ratifies, accepts or approves this Treaty or accedes thereto after the deposit of the thirtieth instrument of ratification, acceptance or approval, it shall enter into force on the ninetieth day after the date of deposit by such state (...) of its instrument of ratification, acceptance, approval or accession. (...)”

50. Most States ratified the ECT, in conformity with Article 39 ECT, within a few years after signing. The Netherlands, for example, approved the ECT by means of a Kingdom Act.²⁹

²⁶ Article 42 ECT: "1. Any Contracting Party may propose amendments to this Treaty. 2. The text of any proposed amendment to this Treaty shall be communicated to the Contracting Parties by the Secretariat at least three months before the date on which it is proposed for adoption by the Charter Conference. 3. Amendments to this Treaty, texts of which have been adopted by the Charter Conference, shall be communicated by the Secretariat to the Depositary which shall submit them to all Contracting Parties for ratification, acceptance or approval. 4. Instruments of ratification, acceptance or approval of amendments to this Treaty shall be deposited with the Depositary. Amendments shall enter into force between Contracting Parties having ratified, accepted or approved them on the ninetieth day after deposit with the Depositary of instruments of ratification, acceptance or approval by at least three-fourths of the Contracting Parties. Thereafter the amendments shall enter into force for any other Contracting Party on the ninetieth day after that Contracting Party deposits its instrument of ratification, acceptance or approval of the amendments."

²⁷ *Parliamentary Papers II*, 1995/96, 24545 (R 1560), 3, p. 3 (Explanatory Memorandum).

²⁸ See Judgment, grounds 5.66-5.73, in which the District Court correctly explains that the binding force of the ECT is subject to ratification. The signing concerns at most a signature subject to ratification within the meaning of Article 14(1)(d) VCLT. The District Court correctly considered the following in ground 5.72 under Article 14 VCLT: "*The entry into force cannot take place by signing. This is not in dispute either.*" In the SoRej., footnote 134, HVY wrongly state that it is undisputed that Davydov could bind the Russian Federation pursuant to Articles 7(1) and 12(1)(a) VCLT. This is therefore incorrect, see also §§ 53, 138 of the SoR.

²⁹ *Parliamentary Papers II*, 1995/96, 24545 (R 1560), 3, p. 3 (Explanatory Memorandum). The Dutch Senate (*Eerste Kamer*) passed the proposal for the Kingdom Act on 14 May 1996 (*Parliamentary Papers I*, 1995/96, 24545 (R 1560), 31, p. 1522).

However, the ratification of a treaty is certainly not a mere procedural formality. It is quite conceivable that the internal constitutional or statutory procedures are not successfully completed in one or more States. In particular, it could turn out after the signing of the Treaty that there is not enough domestic political support to consent to a treaty. For example, Norway and Australia did sign the ECT, but never ratified it. The required approval was never obtained in the Russian Federation either. The Russian government did submit a legislative proposal for the approval of the ECT to the lower chamber of the Federal Parliament (the Duma). The Duma discussed the Treaty twice, but – due to substantive objections – never ratified the ECT in the end.³⁰

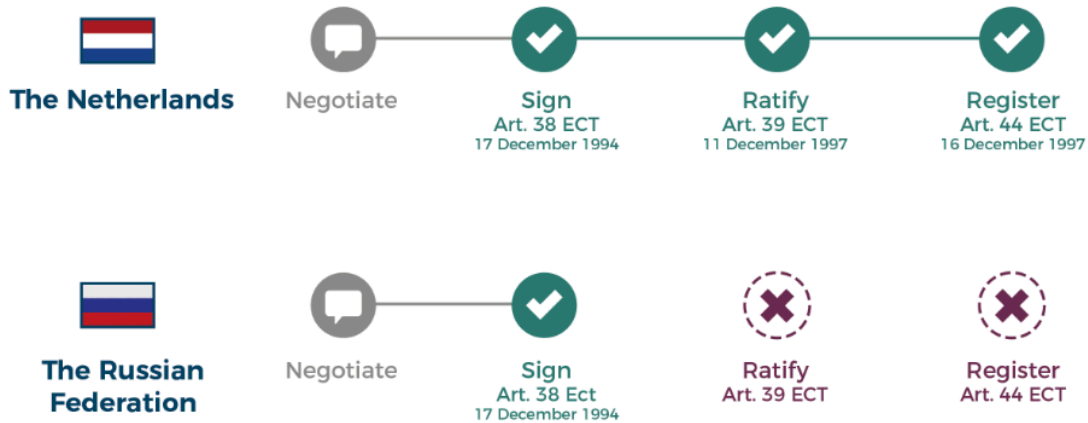

51. It is evident from the above that the ECT prioritizes ratification.³¹ The Russian Federation has not ratified the Treaty. It is not a Contracting Party and the Treaty never entered into force for the Russian Federation.

(b) *Provisional application and the interpretation of Article 45(1) ECT*

52. Because parliamentary approval of a treaty is a time-consuming affair, treaties sometimes determine that they should be provisionally applied by the signatories in anticipation of

³⁰ See Writ, § 117. See also § 311 below. The composition of the Duma changed between both moments in 1997 and 2001.

³¹ This is not disputed. See also Judgment, ground 5.6: "Before discussing the meaning of Article 45 ECT, the Court reminds the parties that the Russian Federation has not ratified the ECT. Article 39 ECT mainly pertains to ratification, as does Article 44, which relates to the entry into force of the Treaty. However, by way of exception, the Treaty also provides the option of 'provisional application', laid down in Article 45."

approval.³² The word “*provisional*” indicates that the treaty is being applied “*in anticipation of something more definite*”, namely the moment the State involved becomes a party to the treaty by ratification.³³

53. The principle of the separation of powers implies that a government’s power to apply treaties provisionally on behalf of a State is just as limited as the power to conclude treaties on behalf of a State. Traditionally, the premise under Dutch constitutional law is that the government can bring about a treaty's provisional application “*if the provisional application is limited to what the government can implement without requiring parliament's further cooperation.*”³⁴ This starting point was later laid down in Article 15(2) of the RGBV. This provision prohibits the government from bringing about the provisional application of a treaty if the treaty deviates from the law or necessitates such deviation from the law.³⁵ The government’s power to provisionally apply treaties on behalf of the State is limited in other States as well, including France, Germany, Austria, Finland and the Russian Federation.³⁶
54. That the governments’ powers to bring about the provisional application of a treaty are limited is in line with the constitutional principle of the separation of powers. Indeed, any other view would imply that a government would be able to unilaterally, i.e. without Parliament's consent, deviate from formally adopted legislation. It is well-known that the principle of the separation of powers is at odds with the desire to apply treaties

³² Writ, § 118.

³³ See *Parliamentary Papers II*, 1982/83, 17798 (R 1227), no. 3, p. 16.

³⁴ *Parliamentary Papers II*, 1988/89, 2214 (R 1375), 3, p. 21 (Explanatory Memorandum). See also H.H.M. Sondaal, *De Nederlandse Verdragspraktijk* (diss.) Den Haag: T.M.C. Asser Instituut, 1986, p. 9.

³⁵ The text of this provision reads as follows: “*With regard to a treaty that requires the approval of the States General before its entry into force, provisional application is not permitted with respect to provisions of that treaty that deviate from the law or [that necessitate such deviations].*” For a further description of Dutch law, see the enclosed expert opinion of Professor Heringa, a Professor of Constitutional Law at Maastricht University, *Voorlopige toepassing in het Nederlandse constitutionele recht*, dated 25 July 2017 (“**Professor Heringa’s Expert Opinion**”, **Exhibit RF-D1**), parts II-IV.

³⁶ HVY’s assertion in the SoA, § 425 that public bodies negotiating a treaty are thus also authorized to apply a treaty provisionally is simply incorrect. See, *inter alia*, Koskeniemi’s Expert Opinion (**Exhibit RF-03.1.C-1.3.4**), § 23, Professor Talus’s Expert Opinion (**Exhibit RF-D11**), §§ 26-30, Professor Nolte’s 2006 Expert Opinion (**Exhibit RF-03.1.C-1.3.7**), § 38, Professor Nolte’s 2016 Expert Opinion (**Exhibit RF-D12**), §§ 20-31, 51, Hafner’s Expert Opinion (**Exhibit RF-03.1.C-1.3.11**), §§ 22-26, Professor Pellet’s 2006 Expert Opinion (**Exhibit RF-03.1.C-1.3.9**), §§ 34-35, Professor Nouvel’s Expert Opinion, §§ 39-69 (**Exhibit RF-D10**). Russian law is addressed in greater detail in chapter II.C(b)(i) et seq.

provisionally prior to the Parliament's possible approval.³⁷ For example, multiple States indicated the same during meetings of the United Nations General Assembly's Legal Committee in 2012 and 2013.³⁸

55. In order to accommodate constitutional requirements, provisional application is sometimes completely waived. In other cases, such requirements are met because States agree that they will apply a treaty provisionally only in part. A good example is the recently-signed EU-Canada Comprehensive Economic Trade Agreement ("**CETA treaty**"). Large parts of this treaty have been applied provisionally since 21 September 2017.³⁹ Other parts, including the (controversial) provisions in the CETA treaty that pertain to investment dispute resolution through arbitration, are not applied provisionally.⁴⁰
56. Treaties sometimes stipulate that each signatory will apply a treaty only provisionally to the extent that this is consistent with the national law of that signatory (*limitation clause*).⁴¹ By way of example, reference can be made to Article 68(1) of the Agreement on an International Energy Programme that was concluded in 1974:

“Notwithstanding the provisions of Article 67 [entry into force], this Agreement shall be applied provisionally by all Signatory States, to the extent possible not inconsistent with their legislation, as from 18th November, 1974 following the first meeting of the Governing Board.”⁴² (emphasis added)

57. A treaty provision such as Article 68 of the Agreement on an International Energy Programme is perfectly acceptable under international law.⁴³ Such a provision prevents that

³⁷ See H.H.M. Sondaal, *De Nederlandse Verdragspraktijk* (diss.) Den Haag: T.M.C. Asser Instituut, 1986, p. 179. Sondaal indicates that a treaty provision which obliges a party to apply a treaty provisionally before parliamentary approval has been granted is problematic "*from a constitutional point of view*". This also played a role in the formation of the ECT.

³⁸ See *inter alia* Writ, § 119.

³⁹ See Article 30.7 of the CETA Treaty.

⁴⁰ See the Declaration from the Council of the European Union, Comprehensive Economic and Trade Agreement (CETA) between Canada, of the one part, and the European Union and its Member States, of the other part, 27 October 2016, Statement 36: "*CETA aims at a major reform of investment dispute resolution (...) All of these provisions having been excluded from the scope of provisional application of CETA, the Commission and the Council confirm that they will not enter into force before the ratification of CETA by all Member States, each in accordance with its own constitutional procedures.*"

⁴¹ See the many examples mentioned in the Writ, § 120, and SoR, §§ 71, 213.

⁴² See (R-275). See also Second Memorial on Jurisdiction and Admissibility, § 53.

⁴³ See Professor Nolte's expert opinion, "Estoppel, Acquiescence and Good Faith in the Context of the Provisional Application of the Energy Charter Treaty by the Russian Federation", dated 9 November 2017 ("**Professor Nolte's 2017 Expert Opinion**", **Exhibit RF-D2**), § 8, with reference to a recent Report

conflict may arise between international treaty obligations and the national law of the signatories. Such a provision prevents that a representative of the government signing for the provisional application exceeds his or her internal powers.⁴⁴

58. During the formation of the ECT, the government leaders were aware of the fact that their powers are limited under national law. In order to meet constitutional limitations, they chose an approach that corresponds to (and is inspired by⁴⁵) Article 68 of the Agreement on an International Energy Programme. Such a provision was ultimately included in Article 45(1) ECT.
59. Article 45(1) ECT reads – in the Dutch and English versions – as follows:

“Each signatory agrees to apply this Treaty provisionally pending its entry into force for such signatory in accordance with Article 44, to the extent that such provisional application is not inconsistent with its constitution, laws or regulations.”

of the UN Commission for International Law, *Report of the Commission on the work of the sixty-ninth session* (2017), A/72/10 (http://legal.un.org/docs/?path=../ilc/reports/2017/english/chp5.pdf&lang=EFSRAC), p. 130. Draft Guideline 11: *Agreement to provisional application with limitations deriving from internal law of States or rules of international organizations*

The present draft guidelines are without prejudice to the right of a State or an international organization to agree in the treaty itself or otherwise to the provisional application of the treaty or a part of the treaty with limitations deriving from the internal law of the State or from the rules of the organization.”

⁴⁴ See for example Michael Polkinghorn and Laurent Gouiffes, "Provisional application of the Energy Charter Treaty: the conundrum" in Graham Coop (ed.) *Energy Dispute Resolution: Investment Protection, Transit and the Energy Charter Treaty*, 2011, pp. 249-282 (**Exhibit RF-227**), p. 259: "Terms subjecting the provisional application of treaties to national legislation similar to Article 45(1) of the ECT are not new. Such terms are motivated by the desire of the representatives of negotiating states to apply the treaty (provisionally) without infringing on the limits of their powers imposed by national laws in this respect." Original English text: "Terms subjecting the provisional application of treaties to national legislation similar to Article 45(1) of the ECT are not new. Such terms are motivated by the desire of the representatives of negotiating states to apply the treaty (provisionally) without infringing on the limits of their powers imposed by national laws in this respect."

⁴⁵ The provision from the Agreement on an International Energy Programme was explicitly discussed in the formation of Article 45 ECT. See the fax from Lise Weis to Hungary, Romania and Norway regarding provisional application dated 18 January 1993, **Exhibit RF-228**: Translation of the original text: "For the purpose of redrafting provisions on Provisional Application to the Energy Charter Treaty, an Interim Agreement to the Treaty based on the wording of the IEA International Energy Program has been considered. Please note that the countries concerned (except your own) are parties to that agreement." Original English text: "For the purpose of redrafting provisions on Provisional Application to the Energy Charter Treaty, an Interim Agreement to the Treaty based on the wording of the IEA International Energy Program has been considered. Please note that the countries concerned (except your own) are parties to that agreement." See also the Fax from Lise Weis (Energy Charter Secretariat) to G. Tanja, G. Houttuin and A. Young dated 10 January 1994 on alternative wordings for the article on provisional application of the ECT (**Exhibit RF-229**).

“Each signatory agrees to apply this Treaty provisionally pending its entry into force for such signatory in accordance with Article 44, to the extent that such provisional application is not inconsistent with its constitution, laws or regulations.”

60. The correct interpretation of Article 45(1) is at the centre of these setting aside proceedings on appeal. Both the Arbitrations and the proceedings in the first instance paid particular attention to the interpretation of the final phrase: *“to the extent that such provisional application is not inconsistent with its constitution, laws or regulations.”* The Tribunal – and later the District Court⁴⁶ – refer to this phrase as the **“Limitation Clause”**.
61. According to the Tribunal, Article 45(1) ECT has an all-or-nothing nature: Either the *“entire Treaty is applied provisionally”*, if the provisional application as such is possible in the State in question, or *“it is not applied provisionally at all”*, if the provisional application of treaties as such is ruled out.⁴⁷ The Tribunal ruled that the Russian Federation had signed the ECT and was obliged to apply the Treaty provisionally in its entirety, including the arbitration rules. The Tribunal summarized its findings as follows:

“394. In this chapter, the Tribunal has found that:

(...)

c) The Limitation Clause of Article 45(1) negates provisional application of the Treaty only where the principle of provisional application is itself inconsistent with the Constitution, laws or regulations of the signatory State; and

d) In the Russian Federation, there is no inconsistency between the provisional application of treaties and its Constitution, laws or regulations.

395. Accordingly, the Tribunal has concluded that the ECT in its entirety applied provisionally in the Russian Federation until 19 October 2009, and that Parts III and V of the Treaty (including Article 26 thereof) remain in force until 19 October 2029 for any investments made prior to 19 October 2009. Respondent is thus bound by the investor-State arbitration provision invoked by Claimant.”⁴⁸

⁴⁶ See Judgment, ground 5.7: *“The District Court will, in accordance with the terminology used in the Interim Awards, refer to this proviso as the “Limitation Clause”.*

⁴⁷ HEL Interim Award, marginal 311. See also HEL Interim Award, marginal nos. 303-329, and SoD, §§ II.105 et seq.

⁴⁸ HEL Interim Award, marginal no. 394.

62. The District Court rejected the Tribunal's interpretation and set aside the Yukos Awards. Following the Russian Federation's arguments, the District Court ruled that the scope of the provisional application was limited. As briefly explained above, the District Court ruled that Article 45(1) ECT implies that signatory states apply the ECT provisionally to the extent that this is not inconsistent with their own national legal system. This may result in a signatory applying certain specific treaty provisions provisionally, while other treaty provisions are excluded from the provisional application. In the words of the District Court: the Russian Federation was "*only bound (...) by the Treaty Provisions that are consistent with Russian law.*"⁴⁹ The findings of the Tribunal and the District Court will be discussed in more detail below.

(c) ***The District Court correctly ruled that Article 45 ECT provides for limited provisional application***

(c)(i) *Introduction: applicable rules of interpretation (ground 5.9)*

63. The District Court correctly ruled that Article 45 ECT must be interpreted in accordance with the mechanism laid down in Articles 31 and 32 VCLT.⁵⁰ According to the general rule of interpretation in Article 31(1) VCLT, a treaty shall be interpreted "*in good faith*", "*in accordance with the ordinary meaning to be given to the terms of the Treaty in their context and in the light of its object and purpose.*" Subsequent agreement relating to the treaty, or subsequent practice in the application of the treaty, which establishes the agreement between the States regarding the treaty's interpretation, should also be included in the interpretation pursuant to Article 31(2) and (3)(b) VCLT. Pursuant to Article 32 VCLT, supplemental means of interpretation may be invoked to confirm the meaning resulting from the application of Article 31 VCLT or to determine the meaning when the interpretation leaves the meaning ambiguous or obscure, or leads to manifestly absurd or unreasonable results. Belonging to the supplemental means of interpretation are the preparatory works (*travaux préparatoires*) in the formation of a treaty.

(c)(ii) *The ordinary meaning of Article 45(1) ECT (grounds 5.10-5.12)*

64. When interpreting Article 45 ECT, the District Court looked in particular at the words "*to the extent*" in Article 45(1) ECT:

⁴⁹ Judgment, ground 5.23.

⁵⁰ Judgment, ground 5.9. This is not disputed. See also, for example, SoA § 242.

“Each signatory agrees to apply this Treaty provisionally pending its entry into force for such signatory in accordance with Article 44, to the extent that such provisional application is not inconsistent with its constitution, laws or regulations.” (emphasis added)

65. According to the District Court, the ordinary meaning of the wording in Article 45(1) ECT indicates that signatories provisionally apply parts of the Treaty that are consistent with national law. In the words of the District Court:

"5.10. In interpreting Article 45 paragraph 1 ECT, the ordinary meaning of phrases is paramount. This particularly concerns the word ‘extent’, which the Oxford Thesaurus of English defines as ‘degree, scale, level, magnitude, scope, extensiveness, amount, size; coverage, breadth, width, reach and range.’ This dovetails with the Russian Federation’s stated description of the words ‘to the extent’ and which it derived from the Oxford English dictionary (second edition, 1989) and Webster’s Third International Dictionary of the English Language (1961): ‘to the extent’: ‘space or degree to which anything is extended’, ‘width of application, operation, etc. scope’, ‘range (as of inclusiveness or application) over which something extends’ and ‘the limit to which something extends’.

5.11. The term ‘to the extent’ in common parlance signifies a degree of application, scope or – formulated slightly differently – a differentiation. This meaning is also expressed in several other language versions of the treaty. For instance, in the German-language version, the term is translated as ‘*in dem Maße*’, in the French-language version as ‘*dans la mesure où*’ and in the Dutch-language version as ‘*voor zover*’.

5.12. Separate from their context, the ordinary meaning of these words is more indicative of the accuracy of the explanation put forward by the Russian Federation. After all, in the interpretation of the Tribunal – in which the word ‘if’ would be more fitting – the Limitation Clause is limited to one form of irreconcilability with national law, namely a ban on provisional application itself. (...)

66. The District Court established the ordinary meaning of the terms in the Treaty correctly.⁵¹ It follows from the semantic interpretation of the Limitation Clause that the scope of the provisional application is limited. The words "*to the extent*" make it clear that the treaty is applied provisionally by signatories. The words "*to the extent that this provisional application is not inconsistent with (...)*" make it clear that it relates to whether the provisional application is inconsistent with national laws and regulations in specific

⁵¹ See Professor Alain Pellet’s expert opinion on Article 45 of the Energy Charter Treaty, dated 10 November 2017, ("**Professor Pellet’s 2017 Expert Opinion**", **Exhibit RF-D3**), §§ 7-10. See also S. Pritzkow, *Das völkerrechtliche Verhältnis zwischen der EU und Russland im Energiesektor*, Springer, 2011, p.62 (**Exhibit RF-230**). Pritzkow discusses different language versions and establishes that the words "*to the extent*" are inconsistent with the all-or-nothing approach accepted by the Tribunal.

cases.⁵² In specific cases, the exact scope of provisional application by any State depends on the consistency of *separate provisions* of the ECT with the Constitution, laws or regulations of the State concerned.⁵³

67. In this context, the District Court referred to the ordinary meaning of the words “*to the extent*” as it is described in dictionaries. The District Court considered that this is also demonstrated by the wording chosen in the other (authentic) language versions of the Treaty. The wording in, among others, German, French, Italian and Dutch have the very same meaning (“*in dem Maße*”, “*dans la mesure où*”, “*nei limiti in cui*”, “*voor zover*”).⁵⁴ Similar words have been deliberately chosen in the authentic Russian language version as well, as will be explained below in § 99.
68. To the contrary, the Tribunal ruled – even though neither of the parties argued this – that the word “*such*” in Article 45(1) ECT is of decisive importance in the interpretation of the provision. According to the Tribunal, this shows that Article 45(1) ECT calls for provisional application of the entire Treaty, unless provisional application of treaties as such is ruled out in the national legal system (*all-or-nothing*):

“303. The Tribunal finds that neither party has properly parsed the Limitation Clause of Article 45(1). (...)

304. For the Tribunal, the key to the interpretation of the Limitation Clause rests in the use of the adjective ‘*such*’ in the phrase ‘*such provisional application*’. (...) The phrase ‘*such provisional application*’, as used in Article 45(1), therefore refers to the provisional application previously mentioned in that Article, namely the provisional application of ‘*this Treaty*’. (...)

305. (...) Accordingly, Article 45(1) can therefore be read as follows:

(1) Each signatory agrees to apply this Treaty provisionally pending its entry into force for such signatory in accordance with Article 44, to the extent that the provisional application of this Treaty is not inconsistent with its constitution, laws or regulations.

(...) 308. There are two possible interpretations of the phrase ‘*the provisional application of this Treaty*’: it can mean either ‘*the provisional application of*

⁵² See also §§ 162 (and 111, 150, 157) of the SoR. However, contrary to what HVY and the Tribunal believe, it is not about whether the principle of provisional application as such is consistent with Dutch law.

⁵³ See Writ, §§ 137-143, and SoR, §§ 67-70.

⁵⁴ Pursuant to Article 50 ECT, the English, French, German, Italian Russian and Spanish texts are authentic.

the entire Treaty’ or ‘the provisional application of some parts of the Treaty’. The Tribunal finds that, in context, the former interpretation accords better with the ordinary meaning that should be given to the terms, as required by Article 31(1) of the VCLT. Indeed, without any further qualification, it is to be presumed that a reference to ‘this Treaty’ is meant to refer to the Treaty as a whole, and not only part of the Treaty.” (emphasis added)⁵⁵

69. This all-or-nothing interpretation, which HVY also advocate⁵⁶, does not correspond with the ordinary meaning of the treaty provision. This interpretation implies that the word "*such*" in Article 45 ECT, to which the Tribunal attributed a lot of meaning, in fact becomes meaningless. The word "such" could, in that case, just as well have been omitted. The District Court rejected this interpretation by the Tribunal. The District Court ruled that the imaginary additions proposed by the Tribunal to the text of Article 45 ECT do not clarify anything:

"5.12 (...) The Tribunal has specifically acknowledged that the drafters of a treaty or legislative provision often use the term ‘to the extent’ to indicate that a provision can only be applied to the extent to which the subsequent words are complied with. However, considering the context in which this term should be placed, the Tribunal attached decisive importance to the adjective ‘such’. According to the Tribunal, the words ‘such provisional application’ only refer to the term ‘this Treaty’ mentioned earlier in Article 45 paragraph 1, and it concerns whether or not ‘such provisional application of this Treaty’ is not contrary to national law. The court holds that this notional addition does not provide clarity. This reference to the treaty, which is evident – another interpretation is after all inconceivable – does not provide clarity on the question whether the provisional application can only relate to the Treaty as a whole, and therefore to the provisional application principle, or only parts of the treaty, meaning particular treaty provisions. Special significance can therefore not be attached to the reference to ‘this Treaty’ in the interpretation of the Limitation Clause.”

70. In essence, the interpretation of Article 45 ECT proposed by HVY, therefore reads that the Treaty should be applied as a whole if the principle of provisional application as such is completely ruled out. This is a substantial reformulation of the treaty text. That interpretation completely deprives the words "*to the extent*" of their meaning. As the

⁵⁵ HEL Interim Award, marginal nos. 304-308.

⁵⁶ The Russian Federation contests the assertion in §§ 290 (and 307, 320-324) of the SoA, which has not been explained in detail, that the word "*such*" implies that the point is whether the principle of provisional application as such is in accordance with Russian law. This interpretation, as also accepted by the Tribunal, is incorrect, as will be explained below. See, among others, §§ 72 and 87-92 below.

UNOFFICIAL TRANSLATION

This text is an unofficial translation of the Dutch original. In case of any discrepancies, the Dutch original shall prevail.

District Court rightly noted⁵⁷, the words “if”, “in the event that” or “unless” befit the Tribunal’s interpretation. HVY try to resolve this in these appeal proceedings by asserting that, linguistically, “to the extent” means (or could mean) the same as “if”.⁵⁸ This is incorrect⁵⁹ and, moreover, incompatible with the intention of the negotiating States. At the time of the negotiations, the words “to the extent” were very deliberately chosen. It was explicitly indicated in that respect that this formulation implies something different than “if” (see §§ 97 et seq. below).

(c)(iii) *The context of Article 45(1) ECT (grounds 5.13-5.16)*

71. Pursuant to the provisions of Article 31 VCLT, the context is important when interpreting the words “to the extent” in Article 45(1) ECT. Article 45 ECT contains a separate comprehensive arrangement on the provisional application of the Treaty.⁶⁰ The provision as a whole is relevant to the interpretation of the words “to the extent” in Article 45(1) ECT.⁶¹
72. The District Court considered Article 45 ECT as a whole. In this context, the District Court rightly remarked that Article 45(1) ECT also expressly concerns the inconsistency with secondary legislation (“regulations”).⁶² This means that Article 45(1) ECT is not limited to the question whether the principle of provisional application is accepted as such. After all, a prohibition on the provisional application of treaties is usually the result of constitutional requirements or laws in a formal sense.⁶³ It is difficult to imagine a prohibition on the principle of provisional application of treaties that is included in secondary legislation,

⁵⁷ See Judgment, ground 5.12: “in the interpretation of the Tribunal – in which the word “if” would be more fitting (...)”.

⁵⁸ SoA, §§ 305-306.

⁵⁹ HVY do not cite any (English-language) dictionaries from which the ordinary meaning of the words “to the extent” as advocated by them emerges. In Dutch, too, “to the extent” means something different than “if” or “in the event that”. In the digital Van Dale dictionary, “to the extent” is defined as “up to a certain point” or “within a certain limit”.

⁶⁰ See also SoA, §§ 363-366, where HVY also discussed other parts of Article 45 ECT. The incorrect conclusions drawn by HVY in SoA, § 363, have already been refuted in SoR, § 203.

⁶¹ See Professor Pellet’s 2017 Expert Opinion (**Exhibit RF-D3**), §§ 43-57.

⁶² See Judgment, ground 5.13. See also the Writ, § 143.

⁶³ HVY make it appear as if the District Court ruled in ground 5.13 that “regulations” are always lower in the hierarchy than “laws” (SoA, § 343). The District Court has not adopted such a general position. The District Court assumed that it is difficult to imagine that an important subject such as concluding treaties is supposedly not laid down in the Constitution or in the law in a formal sense.

such as a ministerial regulation or municipal bylaws.⁶⁴ However, it is quite likely that separate treaty provisions are inconsistent with regulations. In the words of the District Court:

"5.13. However, what the court does deem relevant for the context-related interpretation is first and foremost the circumstance that Article 45 paragraph 1 ECT links the provisional application to the irreconcilability with not only the 'constitution' and 'laws', but expressly also to 'regulations'. The Russian Federation rightly pointed out that a ban on the provisional application of treaties as such usually results from constitutional requirements and may be enshrined in a formal act. It is, however, inconceivable that a ban on the provisional application of a treaty can be laid down in delegated legislation, given the principal nature of a ban. But it is conceivable that a test of compatibility of individual treaty provisions is laid down in delegated legislation. (...)"

73. This opinion of the District Court is in line with the opinion of the expert engaged by HVY in the Arbitrations, Professor Reisman. In 2011, the expert concluded the following in a scholarly publication:

"The last phrase in Article 45(1), namely 'its constitution, laws and regulations', also compels the conclusion that Article 45(1) refers to provisional application of various obligations of the Treaty. (...) It is, to say the least, difficult to imagine how an issue as important as the authority of a state to provisionally apply a treaty would be decided by 'regulation'. By contrast, arrangements for specific matters covered by the ECT would normally be effected within a state not only by authorizations, or prohibitions expressed in the constitution and laws of a state, but also in regulations dealing with particular issues addressed in the Treaty."⁶⁵

⁶⁴ This is at most conceivable in dictatorships lacking a fundamental separation of the powers. It is therefore telling that the only example HVY managed to find concerns secondary legislation issued by General Franco (see SoA, § 346, and Schrijver's Expert Opinion, § 62). What HVY and Schrijver state in this context is furthermore incorrect and misleading. The Spanish decree 801/1972 that was drawn up at the time was intended to adjust Spanish regulations to the VCLT and to take measures for internal procedures regarding the administration, registration and publication of treaties. The decree only contains two provisions about the manner in which treaties must be provisionally applied. Article 20(2) determines that the government must inform parliament about the decision to provisionally apply a treaty. Article 30 determines that the treaty must be published in the official Bulletin of Acts and Decrees. This secondary legislation does not determine anything regarding the power to provisionally apply treaties. After all, this arises from Article 14 of the Ley Constitutiva de las Cortes de 1942 and Article 6 en 9 of the Ley Orgánica del Estado de 1967. This statutory provision arranges for the power of the government to conclude treaties. The decree is no more than a single regulation to support constitutional regulations. After the democracy in Spain was restored, a federal law was still enacted to promote the unity of the legislation regarding the conclusion of treaties.

⁶⁵ Michael W. Reisman, Mahnoush H. Arsanjani, Provisional Application Of Treaties In International Law: The Energy Charter Awards, in: The Law of Treaties Beyond the Vienna Convention (Enzo Cannizzaro ed. 2011), p. 93 (**Exhibit RF-21**) as also referred to in the SoR, § 71.

74. The District Court furthermore discussed the provisions of Article 45(2) ECT. This treaty provision contains an exception based on which a signatory can fully waive provisional application by submitting a declaration to that end. Article 45(2)(c) ECT reads that in such a case, Part VII⁶⁶ of the ECT should nevertheless be provisionally applied "*to the extent that such provisional application is not inconsistent with its laws or regulations*".

“Article 45. Provisional application

1 Each signatory agrees to apply this Treaty provisionally pending its entry into force for such signatory in accordance with Article 44, to the extent that such provisional application is not inconsistent with its constitution, laws or regulations.”

2 a. Notwithstanding paragraph (1) any signatory may, when signing, deliver to the Depositary a declaration that it is not able to accept provisional application. The obligation contained in paragraph (1) shall not apply to a signatory making such a declaration. (...)

c. Notwithstanding subparagraph (a), any signatory making a declaration referred to in subparagraph (a) shall apply Part VII provisionally pending the entry into force of the Treaty for such signatory in accordance with Article 44, to the extent that such provisional application is not inconsistent with its laws or regulations.” (emphasis added)

75. Article 45(2) ECT contains the same “to the extent” wording as Article 45(1) ECT and is based on it as well.⁶⁷ The wording in Article 45(2)(c) ECT naturally concerns the provisional application of a part of the Treaty. The District Court rightly held that a consistent interpretation of Article 45(1) ECT and Article 45(2) ECT supports the position of the Russian Federation:

“5.14 Regarding the context in which the explanation of the Limitation Clause should take place, Article 45 paragraph 2 ECT is also relevant. At the time of signing, a state can submit a declaration that it is not able to accept provisional application (Article 45 paragraph 2 under a ECT). For such situations, Article 45 paragraph 2 under c provides for the Signatory to nevertheless comply with the provisional application ‘to the extent that such provisional application is

⁶⁶ This part of the Treaty comprises Articles 33-37 ECT and pertains to "*structure and institutions*".

⁶⁷ See the Memo: State of affairs regarding CT articles which have not been addressed yet, dated 13 August 1993 (Ministry of Economic Affairs) (**Exhibit RF-231**) " Art. 50 (provisional application): the proposed new text comes from a previous proposal that was submitted by [omitted] (...) Point must be addressed again in the ad-hoc consultations. [omitted] the preliminary relief judge has been informed. [omitted] must point to this legal problem, after which a hearing in a legal subgroup will be the obvious step (for example, same addition as in paragraph 1: 'to the extent not inconsistent with constitutional requirements')." See also §§ 93-96 below.

not inconsistent with its laws and regulations’ of Part VII of the Treaty (‘Structure and Institutions’). (...)

5.15. Since the provisional application in Article 45 paragraph 2 under c remains limited to Part VII, this alone does not make it evident that in this provision the principle of provisional application is designated as a relevant criterion. After all, such a principle can only concern a treaty as a whole; and it is not conceivable that it regards part of a treaty. This was also acknowledged in the Interim Awards under 311 in the consideration that the Limitation Clause entails an ‘all or nothing’ approach: either the entire Treaty is applied provisionally, or not at all. If Article 45 paragraph 2 under c does cover the provisional application principle, as put forward by the defendants, it is furthermore difficult to understand why this provision lacks ‘the constitution’ as assessment criterion. In light of this, it must be assumed that Article 45 paragraph 2 under c, which makes the scope of the provisional applications exclusively conditional on compatibility of Part VII with legislation, primary or delegated, also covers the specific treaty provisions from that part. The court does not agree with the Tribunal’s explanation if that explanation differs from the interpretation in this section.

5.16. In this respect, the Russian Federation rightly pointed out that in their approach the defendants have lost sight of the interaction between paragraphs 1 and 2 of Article 45 ECT. In their vision (...), a Signatory may only invoke the Limitation Clause if its national laws prohibit provisional application as such and if it has submitted a declaration in the sense of Article 45 paragraph 2. Invocation of the Limitation Clause, which relies on incompatibility of the principle of provisional application with the Constitution and other laws and regulations, appears to be difficult to reconcile with the obligation of Article 45 paragraph 2 under c to, in that case, still apply Part VII ‘to the extent that such provisional application’ is not contrary to said laws and regulations.

5.17. In short, the Tribunal interpreted the Limitation Clause in a way that significantly deviates from the meaning that must be assigned to the corresponding words in Article 45 paragraph 2 under c ECT. In the opinion of the court, there is no proper ground for this deviation. A consistent explanation of both paragraphs supports the interpretation of the Limitation Clause, in the opinion of the Russian Federation.”

76. The District Court’s ruling is correct. Indeed, HVY’s position comes down to the fact that the “to the extent” wording that is included in Article 45(1) ECT should be interpreted differently than the exact same wording in Article 45(2) ECT.⁶⁸ Moreover, it emerges from the *travaux préparatoires* that the “to the extent” wordings of Article 45(2) ECT pertain to specific treaty provisions; and not to the principle of provisional application as such (see § 93 below).

⁶⁸ See also Writ, §§ 144-147, and SoR, §§ 76-78, in which HVY’s previous assertions now repeated in SoA, §§ 364-366, were already refuted.

77. Article 45 ECT contains a comprehensive arrangement on the provisional application. Parts thereof – such as Article 45(3) ECT⁶⁹ – are irrelevant for the interpretation of the Limitation Clause. No relevance attaches either to other treaty provisions that cover different subjects altogether. For that reason, HVY's references to Article 20 ECT (transparency)⁷⁰ and more specifically Article 32 ECT (transitional arrangements)⁷¹ cannot contribute much to a further understanding of Article 45(1) ECT.⁷² Article 32 ECT, for example, has nothing to do with provisional application, consequent to which it must be left out of consideration in the interpretation of Article 45 ECT. Article 32 ECT allows States who ratified the Treaty a transitional period during which they can suspend their obligations under Articles 6, 7, 9, 10, 14, 20 and 22 ECT.⁷³ The idea behind Article 32 ECT was that former Soviet states who ratified the treaty would be allowed a longer transitional period. These States still extensively applied Soviet-era laws and had to adjust their legislation. They were granted some respite to bring their laws into line with the legislation of modern market economies.⁷⁴

⁶⁹ Contrary to what HVY argue in, *inter alia*, SoA, §§ 249-252 and 314, the interpretation advocated by them does not follow from the text of Article 45(3) ECT either. Article 45(3) pertains to the termination of the provisional application. Article 54(3) ECT contains no further provisions regarding the scope of the provisional application and the question of whether signatories should observe transparency in this regard.

⁷⁰ With regard to the (alleged) relevance of Article 20 ECT, see §§ 300 et seq. below.

⁷¹ Article 32 ECT allows States who ratified the Treaty a limited transitional period during which they can suspend some specific (and, in this context, irrelevant) treaty provisions. Briefly put, Article 32 ECT reads as follows: "*Article 32. Transitional arrangements*

1 In recognition of the need for time to adapt to the requirements of a market economy, a Contracting Party listed in Annex T may temporarily suspend full compliance with its obligations under one or more of the following provisions of this Treaty (...):

Article 6(2) and (5)

Article 7(4)

Article 9(1)

Article 10(7) – Specific measures

Article 14(1)(d) – related only to transfer of unspent earnings

Article 20(3)

Article 22(1) and (3)".

⁷² See Professor Pellet's 2017 Expert Opinion (**Exhibit RF-D3**), §§ 56-57.

⁷³ The long explanations in SoA, §§ 350-362, are irrelevant and misleading. With regard to the arrangement of Article 32 ECT, see also § 320 below.

⁷⁴ See Professor Pellet's 2017 Expert Opinion (**Exhibit RF-D3**), §§ 56-57. HVY's suggestion in SoA, §§ 350-362, that Article 32 ECT is supposedly relevant in the interpretation of Article 45 ECT is both

(c)(iv) Object and purpose of the ECT (ground 5.19)

78. Based on Article 31 VCLT, the object and purpose of a treaty are important in its interpretation. The District Court's interpretation of Article 45(1) ECT is in line with the object and purpose of the Treaty.⁷⁵ The objective of provisions such as Article 45(1) ECT is, on the one hand, to facilitate the swiftest possible application of a treaty in anticipation of ratification, and, on the other hand, to accommodate the constitutional problems that come with provisional application of treaties in many States (see §§ 41 et seq. below).⁷⁶
79. Making provisions for potential constitutional problems is exactly what the United States had in mind when it proposed to limit the scope of the provisional application of the ECT (see §§ 87 et seq. below). The District Court was well aware of these objectives and correctly held that:

“5.19 (...) a provision such as the Limitation Clause provides for the solution of conflicts between states' national laws and international obligations that ensue from the provisional application of treaties (...).”

80. Article 45 ECT therefore conforms to the purpose of the Treaty (that is mentioned in the preamble) to (i) shape and expand the international cooperation in the energy sector as soon as possible and also (ii) to establish (in due time) a sound and binding international legal basis for such a cooperation⁷⁷:

“Recalling that all signatories to the Concluding Document of the Hague Conference undertook to pursue the objectives and principles of the European Energy Charter and implement and broaden their cooperation as soon as possible by negotiating in good faith an Energy Charter Treaty and Protocols, and desiring to place the commitments contained in that Charter on a secure and binding international legal basis,” (emphasis added)

incorrect and misleading (see SoR, § 79). For example, HVY cite their expert, Professor Schrijver, who asserts that, supposedly, there was a "*duplication*". Apparently, Schrijver believes that Articles 32 and 45 ECT cover the same subjects. That is incorrect. Article 32 ECT pertains solely to some specific treaty provisions that are not directly relevant in this context. Moreover, Article 32 ECT is in fact meant for States that have approved the ECT. Article 45 ECT and Article 32 ECT contain completely separate arrangements and have completely different purposes.

⁷⁵ See the Judgment, ground 5.19, where the District Court in particular discusses the incorrect opinion of the Tribunal that Articles 26 and 27 VCLT were allegedly violated.

⁷⁶ Writ, § 148, and SoR, §§ 93-96 and 102. Professor Pellet's 2017 Expert Opinion (**Exhibit RF-D3**), §§ 58-64.

⁷⁷ In SoA, §§ 293-299 and 308-309, HVY only emphasize the aspect that States wanted to promote collaboration. They wrongly ignore the constitutional objections that were at hand at the time and the primacy of the Treaty's ratification based on Article 39 ECT.

81. In this context, see a publication of Professor Gazzini from 2015. Gazzini wrote:

“Interpreting Article 45(1) in the sense of admitting partial provisional application would have been perfectly in line with the object and purpose of Article 45, namely making the ECT rapidly applicable between signatories and achieving the broadest possible participation, while accommodating the needs of recalcitrant parties by safeguarding them against the acceptance of commitments inconsistent with their domestic law (and probably giving them time to eliminate such inconsistencies). This is clearly confirmed by the fact that Article 45(1) refers to the constitution, laws and regulations of signatory parties. Significantly, the preamble of the Treaty proclaims the intention of the contracting parties '[t]o implement and broaden their co-operation as soon as possible by negotiating in good faith an Energy Charter Treaty and Protocols, and desiring to place the commitments contained in that Charter on a secure and binding international legal basis.’⁷⁷⁸

82. HVY repeatedly suggest that the purpose of Article 45(1) ECT lies in safeguarding transparency and reciprocity.⁷⁹ As will be explained in more detail in §§ 298 et seq., there is no basis whatsoever for this suggestion and the District Court rightly rejected it.⁸⁰

(c)(v) *State Practice (ground 5.21)*

83. Based on Article 31(3) VCLT, subsequent practice in the application of a treaty (state practice) must be considered in the interpretation of a treaty. The District Court left state practice out of consideration in its opinion about Article 45(1) ECT. As will be explained in §§ 108-121 below, there is a broad consensus – supported by all states involved⁸¹ – about the interpretation of Article 45(1) ECT. This demonstrates that state practice unmistakably supports the District Court's interpretation.⁸² In this context, see for example

⁷⁸ T. Gazzini, "Yukos Universal Limited (Isle of Man) v. The Russian Federation, Provisional Application of the ECT in the Yukos Case" ICSID Review, Vol. 30, No. 2 (2015) pp. 293-302, p. 299 (**Exhibit RF-232**). See also T. Gazzini, *Interpretation of International Treaties*, Hart Publishing 2016, pp. 71-74 (**Exhibit RF-233**).

⁷⁹ See SoD, § II.280, and SoA §§ 244, 248-269, 308-309, 320, 367-368 and 370-374.

⁸⁰ See Judgment, ground 5.28, in which the District Court held that HVY's policy views are no reason to accept obligations not included in the Treaty: "*The argument of the defendants regarding the object and purpose of the ECT can be largely reduced to the already mentioned desirability of transparency and therefore does not lead to a different opinion. The principle of reciprocity mentioned by the defendant in that respect (...) also does not succeed*". See also SoR, §§ 208-214.

⁸¹ The opinion in the Judgment, ground 5.21, must be specified to this extent. Many of the documents the Russian Federation will discuss are actually documents that were shared with all relevant states before or after the negotiations. As an example, we point to the amendments to the Russian text that will be discussed below, which amendments were approved – after signing – by the entire conference.

⁸² Writ, §§ 155-170. See also SoR § 92, wherein it is explained that, when interpreting treaties in practice, international courts regularly take into account documents as referred to by the Russian Federation.

the many statements issued by States pursuant to Article 45(2) ECT. As explained in Professor Pellet's expert opinion, this later application of the Treaty confirms the interpretation that "*provisional application of the Treaty may be only partial 'to the extent that' it does not relate to provisions incompatible with the domestic law of the concerned Party.*"⁸³

(c)(vi) *The travaux préparatoires (ground 5.22)*

(c)(vi)(i) *The ruling of the District Court regarding the travaux préparatoires*

84. The ordinary meaning of the terms in the Treaty in their context and in light of the subject and purpose of the treaty clarify that the interpretation that has been accepted by the District Court is correct. The District Court held that based on Article 31 VCLT, such an interpretation does not lead to an unclear or obscure meaning. Therefore, according to the text of Article 32 VCLT, the *travaux préparatoires* need not be discussed.
85. Nevertheless, the District Court concluded, as it was permitted to do under Article 32 VCLT that the *travaux préparatoires* endorse its interpretation. Indeed, Article 32 VCLT provides that "[r]ecourse may be had to supplementary means of interpretation, including the preparatory work of the treaty and the circumstances of its conclusion, in order to confirm the meaning resulting from the application of article 31", and international courts and arbitral tribunals commonly rely on the *travaux préparatoires* to confirm an interpretation under Article 31 VCLT, even where that interpretation results in a clear meaning.⁸⁴ The District Court's recourse to the *travaux préparatoires* was particularly appropriate in this case, where the interpretation of Article 45(1) ECT has been central to the dispute for over a decade. The District Court held:

"5.22. Another question to be answered concerning the interpretation of Article 45 paragraph 1 ECT is whether significance should be attached to the

⁸³ See Professor Pellet's 2017 Expert Opinion (**Exhibit RF-D3**), § 71. Original English text: "*I have the impression that the subsequent practice of the ECT rather confirms the interpretation defended in this Opinion according to which the provisional application of the Treaty may be only partial 'to the extent that' it does not relate to provisions incompatible with the domestic law of the concerned Party.*"

⁸⁴ See, e.g., *Territorial Dispute (Libyan Arab Jamahiriya/Chad)*, Judgment of 3 February 1994, I.C.J. Reports 1994, p. 6, at 27, § 55 ("The Court considers that it is not necessary to refer to the *travaux préparatoires* to elucidate the content of the 1955 Treaty; but, as in previous cases, it finds it possible by reference to the travaux to confirm its reading of the text"); *Compañía de Aguas del Aconquija S.A. and Vivendi Universal v. Argentine Republic*, ICSID Case No. ARB/97/3, Decision on Annulment dated 3 July 2002, § 69; *Aguas del Tunari, S.A. v. Republic of Bolivia*, ICSID Case No. ARB/02/3, Decision on Respondent's Objection to Jurisdiction dated 21 October 2005, § 266.

travaux préparatoires of the ECT, as mentioned by the Russian Federation. From Article 32 VCLT it follows that if application of the interpretation rules contained in Article 31 leaves the meaning ambiguous or obscure or leads to a result that is manifestly absurd or unreasonable, use may be made of supplemental means of interpretation, specifically of (data from) the preparatory work referred to here. There is no ground to apply this supplemental means of interpretation; the court holds that the explanation – in accordance with Article 31 VCLT – does not lead to an ambiguous or obscure meaning or to a result that is manifestly absurd or unreasonable. Superfluously, the court would like to point out the statement of the Russian Federation concerning the addition of the term ‘regulations’ to the draft text of the Limitation Clause. Mr Bamberger, chairman of the legal advisory committee to the Conference on the ECT, answered the question of the Secretary-General of the Conference on the ECT about the addition of this term as follows:

‘the effect is to suggest that relatively minor impediments in the form of regulations, no matter how insignificant they may be, can be the occasion for failing to apply the Treaty provisionally when in fact those regulations could be brought into conformity without serious effort.’⁸⁵

86. The District Court’s ruling is correct.⁸⁶ To clarify and supplement the District Court’s ruling, the Russian Federation will discuss the formation of Article 45 ECT in detail (it refers also to the timeline on the next page). In addition, it will discuss a number of additional documents that have only recently been made available to third parties by the ECT Secretariat.

⁸⁵ Translation of the quote cited by the District Court.

⁸⁶ See, inter alia, Writ, §§ 171-173. The statement in SoA, § 343, that the District Court allegedly held that the term "*regulations*" always refers to secondary legislation is incorrect. The District Court has not done this.

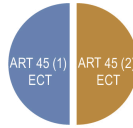

Formulation Article 45 ECT

2 AUGUST 1991

The United States propose to restrict the scope of application of the ECT by adding to Article 45(1) ECT: "*to the extent that their laws allow*".
(DoA, § 87)

14 DECEMBER 1993

Different States indicate that they cannot agree to the principle of provisional application as such. In Article 45(2) ECT a separate "opt-out" arrangement is added by means of which provisional application can be **fully** abandoned. Japan proposes to add similar "*to the extent*" wording to Article 45(2)(c) ECT because it is having problems with one specific institutional treaty provision.
(DoA, §§ 93-94)

10 NOVEMBER 1994

Craig Bamberger (legal adviser ECT) emphasizes that the words "*not inconsistent*" do not have the same meaning as "*subject to*" (DoA, § 99)
According to Lise Weis (legal adviser ECT) the words "*to the extent*" mean that parts of the Treaty can be provisionally applied even if other parts are not applied
(DoA, § 132)

14 DECEMBER 1994

The Joint EC Statement reads that Article 45 ECT does not impose any obligations that go beyond what is compatible with the internal law of the signatories. No statement has to be submitted for this purpose (DoA, § 114)



17 DECEMBER 1994

SIGNING OF THE ECT

17 MAY 1995

In the Russian text of the Treaty the words "*to the extent*" are translated as "*insofar as*". The authentic text and conscious choice of words were (later) approved by the States (DoA, §§ 101-103).

(c)(vi)(ii) *The formation of Article 45(1) ECT: the proposal of the United States clarifies that Article 45(1) ECT does not concern the principle of provisional application as such.*

87. At the time of the ECT's formulation, the government representatives were aware that – based on their own constitutional rules – the ECT could not be applied provisionally without parliamentary consent. The United States already indicated in 1991 that this problem can be repaired by limiting the scope of the provisional application:

“‘Provisional’ application of the Protocol⁸⁷ is not possible in the U.S., where a treaty or legislation is required before such a document can come into force. This could be fixed with: ‘to the extent that their laws allow’ or some similar language.”⁸⁸

88. During the plenary negotiations in 1993, the United States indicated that provisional application is an “exceptional phenomenon” and that one cannot act as if a treaty has already entered into force if it is provisionally applied:

“[W]e need to recognize that provisional application is a rather extraordinary thing. Almost every country represented in this room, if not every country represented in this room, does have internal legal and in many cases constitutional requirements before treaties or international agreements like treaties may enter into force for it. And one has to take the existence of those requirements very seriously. One cannot simply, through a provisional application regime act as if indeed the treaty were already in force and that the process of, say, ratification were a mere formality.” (emphasis added by counsel)⁸⁹

89. At the time, it was clear that many countries could not provisionally apply specific ECT provisions. For example, a representative of the United States indicated that the American constitutional system opposes provisional application of the treaty provision that entails an obligation to contribute to the costs of international institutions. Article 37 ECT provides that Contracting Parties must bear the costs of the ECT Secretariat according to a certain allocation formula. Provisional application of such a treaty provision is allegedly opposed to the American Congress' right to approve and amend budgetary policy:

⁸⁷ The draft text of the Treaty was called the "Basic Protocol" at the time.

⁸⁸ European Energy Charter Conference Secretariat, 6/91, CONF 4 Restricted Note from Secretariat (United States) (**Exhibit RF- 234**).

⁸⁹ Transcript of Energy Charter Conference, Session of December 14, 1993 (United States Representative), 4 (C-924).

“Quite apart from the question of the ultimate resolution of whether there should be institutions, the difficulty of participating in the financing of a provisional organization is particularly acute for the United States. We cannot under our law do it for more than a certain period and so, certainly, we could not provisionally apply the Treaty in respect to the United States in that connection.”⁹⁰ (emphasis added).

90. The fact that entering into a financial obligation could infringe the right to approve and amend budgetary policy of the Parliament was a reason for concern for more States. For example, both Italy⁹¹ and Japan⁹² indicated at the time of the negotiations that the provisional application of Article 37 would not be acceptable for them for that reason.
91. At the time of the negotiations about the text of the ECT the United States, Canada and Norway proposed to limit the scope of the provisional application by signatories.⁹³ The idea behind this was that in this way the constitutional limitations that prevent each of the governments involved from provisionally applying the ECT as a whole under their own legislation would be met. The proposal of the United States was to limit the provisional application “to the extent permitted by its constitution or laws”:

"[W]e do not have any legal difficulty with provisional application per se, so long as it is carefully qualified to ensure that no party is obliged to do, or to refrain from doing, anything for which that party's constitution or law requires an appropriately ratified treaty. Our law, for example, generally speaking prohibits expenditure of funds to pay the U.S. share of the expenses of an international organization absent the express approval of the Congress. For such reasons language along the lines 'to the extent permitted by its constitution or laws' is essential to any provisional application obligation."⁹⁴

⁹⁰ Session of December 14, 1993 (United States Representative) (C-924), 4. SoR, § 97. See also Writ, §§ 145 and 171, with reference to, *inter alia*, **Exhibit RF-113** and C-924.

⁹¹ Fax from Italy to the European Energy Conference Secretariat dated 27 July 1994, Re: Inclusion of Italy in Annex PA (**Exhibit RF-235**): "*Italy cannot consent to the provisional application of the Treaty since Article 80 of the Italian Constitution lays down, inter alia, that international treaties which provide for arbitration, confer juridical [sic.] powers or impose financial burdens must be ratified by Parliament.*"

⁹² European Energy Charter, Room doc. 15, remarks of the Japanese delegation to Article 45 ECT, dated 8 March 1994 (**Exhibit RF-236**): "*We cannot apply Article 37 of Part VII unconditionally after signature, because our domestic legislation prohibits the Japanese Government from committing itself beyond its competence to make payments regarding treaties which have not yet been concluded.*"

⁹³ The United States, Canada and Norway proposed at the time to reformulate and add the provision about provisional application (then Article 41): "*to the extent that such provisional application is not inconsistent with their national laws*". See C-859 and R-466.

⁹⁴ U.S. Department of State: Fax from T. Borek to Energy Charter Secretariat (24 February 1994), 1 (R-844). SoR, § 97. See also Writ, §§ 145 and 171, with reference to, *inter alia*, **Exhibit RF-113** and C-924.

92. The fax that is referred to above shows that the United States has explicitly indicated that it does not object to the principle of provisional application as such. They only wanted to guarantee that a party would not be obliged to do or omit something in respect of which the laws of that party require a treaty that has been correctly ratified. The foregoing quote therefore demonstrates that the words “to the extent” do not concern the inconsistency of the provisional application of the ECT as such with national law (the so-called all-or-nothing interpretation), but inconsistency of specific obligations (such as Article 37 ECT) with national law (the so-called peacemeal interpretation).⁹⁵

(c)(vi)(iii) *The formation of Article 45(2) ECT clarifies that Article 45(1) ECT provides for partial provisional application*

93. For most States, such as the Netherlands, France and the Russian Federation, the text proposed by the United States offered sufficient guarantees to accommodate the constitutional requirements.⁹⁶ Some States deemed the provisional application of treaties such as the ECT undesirable altogether. For example, during the negotiations about the ECT, Switzerland, Austria, Canada, Hungary, Japan, Norway and Romania indicated that they could not or would not be willing to provisionally apply the Treaty.⁹⁷ Some States pointed to political policy considerations, while other States pointed specifically to the role of their national parliaments.⁹⁸

⁹⁵ The statement of HVY in SoA, §§ 329-331, that the *travaux préparatoires* demonstrate that Article 45 ECT concerns the principle of provisional application is therefore incorrect. The quotes referred to above show that the United States had an approach in mind that is entirely in line with the District Court's interpretation. As will be explained above, this cannot be concluded from a Japanese proposal either. On the contrary: the documents that were drawn up in this context support the District Court's interpretation.

⁹⁶ For the Netherlands, see, for example, §§ 23-24 of Professor Heringa's Expert Opinion (**Exhibit RF-D1**).

⁹⁷ For example, Switzerland, Austria, Hungary, Japan, Norway and Romania indicated that provisional application as such was not acceptable to them. See C-879 (General Comment): Original English text: "*Six delegations (CH, A, H, J, N, RO) stated that provisional application was not acceptable to them for different reasons but in most cases for constitutional reasons.*" See C-911 with respect to Switzerland. See also C-924, p. 3-5. The Portuguese Republic indicated that it was not able to provisionally apply the Treaty "for constitutional reasons" see C-904. See also the Memorandum of Jeff Pierson to Mrs Steeg dated 20 December 1993, Re: European Energy Charter Treaty Negotiations 14-18 December 1993 (**Exhibit RF-237**): "*Norway began this discussion by once again proposing deletion of the article, since it 'cannot accept the principle of provisional application,' since it would require consent of the parliament. (...) Hungary, Romania, Japan, Austria and Switzerland also voiced concerns about the parliamentary impact, especially in the sense that there should not be any obligation to apply terms provisionally. Canada then stated the obvious: it will be difficult to accept Article 50 before it is known what will go into the treaty!*" See C-922 for (various) lists with countries that have indicated that they do not want to provisionally apply to ECT.

⁹⁸ See also (**Exhibit RF-237**). This memorandum reports on the plenary sessions of 14-18 December 1993: "*Hungary, Romania, Japan, Austria and Switzerland also voiced concerns about the parliamentary impact, especially in the sense that there should not be any obligation to apply terms provisionally.*"

94. In order to meet such objections and internal political considerations, a separate “*opt out*” arrangement was proposed at a much later time during the negotiations. This arrangement made it possible for States to opt out of provisional application altogether. Such an arrangement was included in Article 45(2) ECT.⁹⁹ Ultimately, two separate arrangements were provided: (1) the arrangement of Article 45(1) ECT that provides for limited and/or partial provisional application and (2) the arrangement of Article 45(2) ECT that enabled the States not to provisionally apply the Treaty at all. In the latter case, the Treaty only provided for the provisional application of Part VII of the ECT (institutional provisions, Articles 33-37 ECT):

“2a. Notwithstanding paragraph (1) any signatory may, when signing, deliver to the Depositary a declaration that it is not able to accept provisional application. The obligation contained in paragraph (1) shall not apply to a signatory making such a declaration. (...)

c. Notwithstanding subparagraph (a), any signatory making a declaration referred to in subparagraph (a) shall apply Part VII provisionally pending the entry into force of the Treaty for such signatory in accordance with Article 44, to the extent that such provisional application is not inconsistent with its laws or regulations.” (emphasis added)

95. Documents that concern the formation of Article 45(2)(c) ECT confirm that the “to the extent” wording in Article 45(1) ECT refers to specific treaty provisions.¹⁰⁰ This is demonstrated by, among other things, Japanese proposals that – contrary to what HVY argue¹⁰¹ – have been accepted with some adjustments. Japan proposed to add wordings

⁹⁹ Article 50(2) of the draft text. In this context, see also II.D(c)(ii) et seq. below.

¹⁰⁰ Among other things, Article 45(2) ECT was discussed during the negotiations that took place from 7 until 11 March 1994. These meetings were summarized as follows: “*Article 50, Provisional Application. A substantial amount of preparatory work on this subject, including the exploration of alternative approaches such as a separate agreement, had been done by the Conference Secretariat prior to this meeting. Moreover, in recognition of the legal and political problems of the participating countries, it was expected that any obligation to apply the Treaty provisionally pending its entry into force would be made subject to the laws of the Treaty signatories. The article was given needed form, however, by a Japanese proposal which was well received in the Conference. The proposal would retain the provisional application article in the Treaty. Under the article a signatory which did not choose to apply the full treaty provisionally could elect not to do so (...)*” Memorandum from Craig Bamberger to Ms Steeg and Mr Ferriter dated 15 March 1994, Re: European Energy Charter Plenary of 7-11 March, (**Exhibit RF-238**), p. 6.

¹⁰¹ The far-reaching conclusions that HVY believe they can draw in SoD, §§ 332-334, based on a Japanese text proposal, are incorrect. Unlike what HVY and Professor Schrijver assert, the Japanese proposal in question was never explicitly rejected. On the contrary, the Japanese proposal they discussed was later accepted with a few adjustments. The essence of this earlier proposal was that States should be given the opportunity to refrain from the provisional application of the Treaty altogether. This proposal was accepted: after all, Article 45(2) ECT was implemented in the end at the insistence of Japan (see §§ 94 et seq. above). Therefore, it cannot be deduced from the first text proposal in any way that States explicitly

similar to the “*to the extent*” wording in Article 50(1) ECT to Article 50(2) of the former draft text (later Article 45(2) ECT). The background was that Japan had a problem with one specific treaty provision which it claimed it could not apply provisionally.¹⁰² This concerned Article 37 ECT, based on which it would be obliged to contribute to the costs of the Secretariat:

“We have a constitutional problem in relation to paragraph (2) of CONF 91, which lacks the phrase ‘accordance with their laws and regulations’. We cannot apply Article 37 of Part VII unconditionally after signature, because our domestic legislation prohibits the Japanese Government from committing itself beyond its competence to make payments regarding treaties which have not yet been concluded.

(...) Therefore, we propose to replace paragraphs (1) and (2) of Article 50 (CONF91) with the following paragraphs (1) to (3) (...)

(3) Notwithstanding paragraph (2) above, signatories making declarations referred to in paragraph (2) above shall apply Part VII of this Treaty provisionally in accordance with their laws and regulations pending its entry into force in accordance with Article 48.”¹⁰³

96. By way of example, a declaration of Italy can be referred to as well. At the time of the negotiations, Italy indicated in a letter that it will issue a declaration that it cannot provisionally apply the Treaty “at all”. In the letter, signatories that provisionally apply the Treaty based on Article 45(1) ECT are referred to as States “*who do apply provisionally at least some part of the Treaty*”.¹⁰⁴

(c)(vi)(iv) *The formation of Article 45(1) ECT: “to the extent” means something entirely different than “if”*

rejected the interpretation accepted by the District Court. HVY submit not a single document demonstrating that, supposedly, that was the reason Japan’s very first text proposal was not accepted.

¹⁰² This also clarifies that the far-reaching conclusions which HVY believes it can draw in SoA, §§ 332-334, based on a Japanese text proposal that was never accepted, do not hold. On the contrary: Japan shares the opinion of the District Court. See also § 120 below.

¹⁰³ Remarks of the Japanese delegation to Article 45 ECT (**Exhibit RF-236**) (emphasis as in original text).

¹⁰⁴ Letter of the permanent representation of Italy to the Secretary General of the European Energy Conference dated 1 September 1994, (C-1012 and C-908). Writ, § 169. Original English text: “*With reference to your letter of August 31st, I am glad to inform you that my authorities agree that the inclusion in Annex PA is necessary only for certain States who do apply provisionally at least some part of the Treaty. Italy will therefore make a declaration at the time of the signature for not being able (for constitutional reasons) to accept provisional application, ‘in toto’, The request to be listed in Annex PA is than not relevant any more.[sic.]*” This immediately makes it clear that HVY’s statements regarding the position Italy allegedly adopted cannot hold (SoA, § 339).

97. HVY asserts that the Treaty as a whole should be applied provisionally if the principle of provisional application as such is not ruled out. To that end they argue, that “to the extent” could mean the same as “if”.¹⁰⁵ This interpretation is hardly substantiated and not in line with the ordinary meaning of the chosen wording and is furthermore incompatible with the intention of the negotiating parties (see § 70 above).
98. First of all, at the time of the negotiations, the European Communities made it clear during a plenary session that the wording “to the extent that” differs from the words “if that”. According to the European Community, the wording in Article 45 ECT¹⁰⁶ implies that the ECT had to be provisionally applied to the extent possible, meaning insofar as permitted by existing laws:

“(…) the language in the existing earlier versions has done two things It has said that signatories who can, whose constitution allows it may apply provisionally the Treaty and, then, by using the expression ‘to the extent that’, not ‘if that’, ‘if to the extent that such provisional application’, not ‘if such provisional application’. It has in addition suggested that there could be provisional application as far as feasible, that is as much as the provisional application as the existing laws and regulations and constitution allow it. This is the way paragraph I of Article 50 CONF 82 can be read (…)¹⁰⁷”

99. Second, see also a fax of Mr Craig Bamberger, the chairman of the Legal Advisory Committee to the ECT Conference, and consequently the most important adviser of the Conference (see also §§ 133 and 147 et seq. below). On 10 November 1994 he wrote that the words “*not inconsistent*” do not mean the same as the words “*subject to*”:

“the obligation is undertaken ‘to the extent not inconsistent with(...)’. This is not quite the same as ‘subject to’.”¹⁰⁸

100. Third, when the Russian text was drawn up, the words “to the extent” and the manner in which they had to be “translated” into Russian were discussed in detail. By the end of the negotiations, it became clear that it was impossible to have all six authentic texts ready for

¹⁰⁵ SoA, §§ 305-306, see also Schrijvers’ expert opinion (HVY), § 58. See also § 70 above.

¹⁰⁶ More specifically: Article 50 of the draft text at the time. The numbering changed shortly before the Treaty was signed.

¹⁰⁷ Report Plenary Sessions dated 10 March 1994, (C-924), p. 25.

¹⁰⁸ Fax from Craig Bamberger to Lise Weis, Re: Clive’s Draft Memo on Provisional Application dated 10 November 1994 (**Exhibit RF-239**).

the signing of the Treaty.¹⁰⁹ In order to expedite the formation of the Russian text and safeguard its quality, the Russian Federation was requested and found willing to provide a contribution by providing linguistic experts.¹¹⁰

101. At the ECT Secretariat's request, the Russian experts looked at the text critically and, based thereon, made many dozens of suggestions and asked the ECT Secretariat several questions.¹¹¹ One of the questions specifically pertains to the translation of the words "to the extent" in Article 45 ECT. The linguistic experts wondered whether this wording should be translated as "insofar as" or as "if":

"P. 71. Para. (2)(c). '...to the extent that' was translated as 'insofar as'. We changed it for 'if'. We would like to double-check (if that changes the meaning?). [This correction has not been included in the text yet.]"¹¹²

102. The ECT Secretariat has adopted most of the Russian experts' linguistic corrections. In response to the question how the words "to the extent" should be "translated", the ECT Secretariat wished to maintain the Russian wording for "insofar as". This is evident from a letter from Mr Sorokin (ECT Secretariat) to Minister Shatalov (Russian Federation) dated 17 May 1995:

"(...) Given the experts' recommendations, we were unable to agree with the corrections (...) in eight cases (...). These concern our following commentaries (...) Article 45(2)(c), p. 78) (...) Based on expert opinions, WE

¹⁰⁹ Letter from Lise Weis to Clive Jones dated 21 October 1994 (**Exhibit RF-240**).

¹¹⁰ Letter from Clive Jones (ECT Secretariat) to A. Shatalov (Deputy Minister of the Ministry of Fuel and Energy of the Russian Federation) dated 20 October 1994 (**Exhibit RF-241**). Original English text: *"Sometime in the second half of November there will be a meeting of Legal linguistic experts arranged by the Council of the European Union's legal service to ensure that the six different language versions of the Treaty and Final Act are fully compatible. This is purely a linguistic exercise which involves no change in policy or substance. Although the Council does, I understand, have Russian 'mother tongue' experts on its staff, it would I believe be useful if you could send two or three Russian government officials to this meeting. The purpose of this letter is to invite your representatives to attend."*

¹¹¹ Letter from Ivanov (Deputy Minister of the Ministry of Foreign Affairs of the Russian Federation) to Shatalov (Deputy Minister of the Ministry of Fuel and Energy of the Russian Federation) dated 30 March 1995 (**Exhibit RF-242**). English translation of the original Russian text: *"We have carefully reviewed the commentaries of the Secretariat of the European Energy Charter to the proofs of the Russian text of the Energy Charter Treaty (ECT) and related documents, prepared by the translators of the Ministry of Foreign Affairs of Russia. Please find enclosed further commentaries.(...) [W]e consider it practicable to create, as part of the newly created Interagency Committee for the Implementation of ECT Provisions, a group of experts from among the economists and lawyers that could study the Secretariat's commentaries. We believe that without this, the preparation of the final Russian text of the Treaty, especially given its forthcoming submission to the State Duma for ratification, is impossible."*

¹¹² See (**Exhibit RF-242**). English translation of the original Russian text.

RECOMMEND CONSIDERING THE FOLLOWING TRANSLATION OF
THE RESPECTIVE TEXT AS FINAL”¹¹³

103. The Russian authorities agreed. The amended Russian text of the Treaty, in which the words “to the extent” were “translated” to the Russian “insofar as”, was approved on 1 June 1995 by four high-ranking government officials, including the Minister of Finance and the Minister of Foreign Affairs of the Russian Federation.¹¹⁴ After approval, the ECT Secretariat presented the Russian text to the other States.¹¹⁵ This Russian text was subsequently approved by the Conference and is considered an authentic text of the Treaty.¹¹⁶
104. The formation of the Russian authentic text of the Treaty shows not only that the wording “to the extent” in Article 45(1) ECT does not mean the same as “if”, it also shows that the representatives of the Russian Federation and the ECT Secretariat expressly emphasized that position at the time.

(c)(vii) Conclusion

105. The District Court concluded that “the normal meaning of the term ‘to the extent’ in paragraph 1 - also given the context - leads to an interpretation (...) whereby the possibility

¹¹³ Letter from Sorokin (ECT Secretariat) to Shatalov (Minister of the Russian Federation) dated 17 May 1995 (**Exhibit RF-243**). The quote in the main text was translated directly from Russian. English translation of the original Russian text.

¹¹⁴ Approval of the Russian translation of the ECT Treaty dated 1 June 1995 (**Exhibit RF-244**). The receipt of the final Russian text of the Treaty was signed by four separate Russian ministers and/or high-ranking officials, to wit V.V. Zotov (Minister of Finance), Yu. A. Yershov (National Research Institute for Foreign Economic Relations), Ye. K. Mikhailova (Central Bank of the Russian Federation) and V.N. Prosin (Minister of Foreign Affairs).

¹¹⁵ Memorandum of the ECT Secretariat on the final text of the Treaty dated 29 June 1995 (**Exhibit RF-245**). English translation of the original Russian text: "*The final texts of the Energy Charter Treaty (including Annexes and Decisions), the Protocol on Energy Efficiency and the Final Act of the Charter Conference in English were circulated on 18 January (document CC 2), while the texts in Spanish, Italian, German and French were circulated on 3 March (document CC 6). Texts in Russian signed in Lisbon, are enclosed hereto (the set is dated 17 December 1994). The Secretariat, as instructed by, and acting on behalf of the Depository, notes the significant mistakes identified in the Russian text of the Energy Charter Treaty signed in Lisbon on 17 December 1994. It is suggested that these mistakes be corrected in accordance with the italicized notes in the enclosed version of 16 June 1995. In case of any objections to these corrections, please inform the Secretariat by 31 July 1995.*"

¹¹⁶ The Russian text is authentic pursuant to Article 50 ECT. That the text, amended and approved at a later date, is the authentic text is confirmed in a letter from Sorokin (ECT Secretariat) to Shatalov (Deputy Minister of the Ministry of Fuel and Energy of the Russian Federation) dated 28 August 1995 (**Exhibit RF-246**). English translation of the original Russian text: "*According to the Document CC 28 dated 28 June of this year, as no Contracting Party informed the Secretariat of its comments and objections to the distributed Russian language translation of the ECT and the connected documents before 31 July of this year, that text is considered to be authentic.*"

of provisional application (...) depends on the compatibility of separate treaty provisions with national law.¹¹⁷ The District Court subsequently rightly concluded that the Russian Federation was only bound by the treaty provisions that are compatible with Russian law.¹¹⁸

(d) ***The District Court's interpretation matches what had already been accepted as the only correct interpretation of Article 45(1) ECT at the time***

106. HVY have repeatedly asserted that the interpretation of the Treaty as accepted by the District Court is “*not serious*” and “*highly questionable*”.¹¹⁹ HVY argue without any further substantiation that this interpretation has been “*fabricated*” and “*made up*” by the Russian Federation after the commencement of the Arbitrations with the mere purpose to “*evade its obligations under the ECT*”.¹²⁰
107. In reality, the District Court's interpretation had been universally accepted as the only correct interpretation of Article 45 ECT long before the Arbitrations commenced. This interpretation of the District Court corresponds to the understanding of Article 45 ECT by

¹¹⁷ Judgment ground 5.18.

¹¹⁸ Judgment, ground 5.22.

¹¹⁹ SoD, §§ 1.59, I.63 and II.190. “*Let us repeat that this cannot be regarded as a serious interpretation of Article 45(1) ECT. It is an interpretation that was created only to evade responsibility for the destruction of Yukos.*” In enforcement proceedings in Belgium, they have construed the opinion of the District Court as “*highly questionable*”. Conclusions Additionnelles Quant au font dated 1 June 2016, (translation of the original French text): “*180. The reasoning of the District Court in The Hague is highly questionable. The District Court completely disregards the generally acknowledged principles of international law, derives Article 45 ECT (which nevertheless prescribes a provisional application of the ECT) of any effect, allows the Russian Federation to avoid its international responsibility even though it signed the ECT and supported a provisional application in tempore non suspecto, and interprets Russian law in a manifestly incorrect manner by relying only on expert advice entered into the proceedings by the Russian Federation.*” Original French text: “*180. Le raisonnement suivi par le Tribunal de première instance de La Haye est hautement critiquable. Il fait totalement fi des principes bien établis du droit international, ôte tout effet à l'article 45 du TCE (lequel prévoit pourtant expressément l'application provisoire du TCE), permet à la Fédération de Russie d'échapper à ses responsabilités internationales alors qu'elle a signé le TCE et soutenu son application provisoire in tempore non suspecto et interprète le droit russe d'une manière manifestement erronée sur le seul fondement des avis d'experts invoqués par la Fédération de Russie pour les besoins de la cause.*”

¹²⁰ SoD, §§ 59-60: “*When HVY subsequently commenced the Arbitrations in 2005 and claimed significant compensation therein, the Russian Federation, eleven years after it had signed the ECT, made a turnaround that caused quite a stir. The Russian Federation fabricated the interpretation of Article 45 ECT in the Arbitrations only to evade the obligations by virtue of the ECT (...)*” SoA, p. 54 “*The position of the Russian Federation (...) was made up by the (lawyers of) the Russian Federation after HVY had initiated the Arbitrations.*” SoA, § 140 “*In the context of the Arbitrations, the Russian Federation then concocted the defence that it did not apply Article 26 ECT provisionally at all.*” SoA, § 544: “*[t]he Russian Federation simply made up its arguments based on Article 45(1) ECT and Russian law after its dispute with HVY had arisen in order to evade an independent review by the Arbitral Tribunal (...)*”.

(i) the Netherlands, (ii) the European Union and all its member states at the time, (iii) representatives of the United States, Italy, the United Kingdom, Finland and Japan, (iv) the Russian Federation before the Arbitrations were initiated, (v) the individuals that were involved in the negotiations on the ECT and (vi) the prevailing view in legal literature.

(d)(i) The Netherlands agrees with the opinion of the District Court

108. Dutch officials who were involved in the conclusion of the ECT agree with the District Court's interpretation.¹²¹ As further substantiation of this position, the Russian Federation submits an expert opinion of Professor Heringa, Professor of Constitutional Law at the University of Maastricht.¹²² Professor Heringa describes the relevant Dutch legislation. In his expert opinion, he refers to a number of documents that were drawn up at the time which demonstrate that (i) the Netherlands relied on the Limitation Clause, (ii) assumed that it would only provisionally apply part of the Treaty and (iii) was of the opinion that no prior declaration was required to rely on Article 45(1) ECT.¹²³
109. Professor Heringa refers to various internal documents that were drawn up by Dutch officials at the time and which concern provisional application of the Treaty. A memorandum of 31 March 1994 directed to the European Cooperation Department (of the Ministry of Foreign Affairs) demonstrates that the Netherlands could agree to the provisional application of the Treaty precisely because of the fact that the scope of provisional application was limited:

¹²¹ The Russian Federation therefore vigorously contests the unsubstantiated statement that the Netherlands agrees with HVY's interpretation (see SoA, §§ 316-317).

¹²² Professor Heringa's Expert Opinion (**Exhibit RF-D1, HER-6**), wherein Heringa addresses provisional application in Dutch constitutional law.

¹²³ Heringa concludes in § 34: *"My conclusion is that both under Dutch law and from the perspective of the Dutch negotiators and from the EU perspective the scope of Article 45 ECT as instrument of provisional application is limited by the extent to which there is a breach of national law. Both Article 45 ECT and Dutch constitutional law do the same thing, to wit assuming that provisional application will only be applied insofar as this is allowed under national constitutional law, so that in the Netherlands this treaty and this provision were entirely in conformity with national law."* Heringa writes the following in §33 about the necessity of a prior statement: *"As can be established, the general opt-out is a heavy remedy under Dutch law. Under Dutch law the limitations of provisional application can be sufficed with insofar as this application is in breach of the rights of parliament (exceeds the powers of the executive power/government) or can result in a breach of national provisions. This can be met by means of an overall opt-out. This may be an obvious option for other states, in view of their constitutional regulations. In the context of this treaty, for the Netherlands such a nuclear option was not necessary given the clause that the automatic provisional application only applies if and insofar as it does not lead to applications that are in breach of national law."* (**Exhibit RF-D1, HER-6**).

“Further to the discussions about the draft Energy Charter (ECT), the following was stated on our part:

Art. 50 (provisional application) has meanwhile been intensively discussed in the plenary conference. The current text of March 1994 (version 7) is approaching its final form. Previous contacts with JURA [unreadable] have demonstrated that the Netherlands does not have any problems with the substance of the article, because paragraph 1 includes the phrase “to the extent that such provisional application is not inconsistent with its laws, regulations or constitutional requirements”. (emphasis added)¹²⁴

110. A Memorandum of 22 April 1994 sent by the Treaties/Treaties Preparation Department to the European Cooperation Department clarifies that provisional application can only extend to specific treaty provisions. Only the treaty provisions with regard to which the government had independent authority qualified to be provisionally applied. The reason for this is that “*the rights of the Parliament*” cannot be assumed.

“Article 50 [Article 45 in the final version] of the Energy Charter Treaty determines that ‘the Signatory State agrees to apply this Treaty provisionally pending its entry into force based on Article 49, to the extent that such provisional application is not inconsistent with its laws, regulations or constitutional requirements.’

(...) Provisional application is possible under constitutional use, if the interest of the Kingdom demands this. The Government must notify Parliament of this interest.

It should therefore not be a problem for the Kingdom if Article 50 is included in its current form. The second and third paragraphs of Article 50 seem to be irrelevant in this context.

It must be noted that the provisional application can only extend to the provisions of the Treaty based on which the Government has independent authority. The Government cannot assume the rights of Parliament.¹²⁵
(emphasis added by counsel)

111. A letter of the Head of the Parliamentary Affairs Section dated 6 September 1994 also demonstrates that the obligation to provisionally apply the ECT based on Article 45 ECT

¹²⁴ Part 1, no. 7 (Part 4 no. 6), Note for the *DES* (European Cooperation Department?) dated 31 March 1994, Professor Heringa’s Expert Opinion (**Exhibit RF-D1, HER-1**).

¹²⁵ Part 1, no. 6 (Part 3 no. 36 and Part 4 no 5), Memorandum dated 22 April 1994 of *DVE/VV* [Treaties/Treaties Preparation Department] to *DES/OB* [European Cooperation Department?], no. 122/94, subject “Provisional application of the Energy Charter Treaty”, Professor Heringa’s Expert Opinion (**Exhibit RF-D1, HER-3**).

(Article 50 of the draft text) was in any case limited to issues falling under the existing authority of the government:

“With reference to our telephone conversation today, I confirm the following. The intention is to submit the ECT and Energy Efficiency Protocol to parliament for explicit approval (as provided by law). (...)

In the section on provisional application, it must also be accounted for why the Netherlands also takes on the 20-year obligation pursuant to Article 50(3)(b), provided that this falls within the existing power of the government, just like the provisional application itself (...). I furthermore refer to the memorandum which the assistant JURA sent to you.” (emphasis added)¹²⁶

112. The government of the Netherlands has furthermore made it known – through the appropriate diplomatic channels¹²⁷ – that the Netherlands agreed with a joint declaration of the European Union and its Member States at the time, which declaration will be discussed below.

(d)(ii) *The European Union and its member states agree with the District Court's interpretation*¹²⁸

113. The ECT partly concerns policy areas that are part of the European Union's exclusive jurisdiction and partly concerns policy areas that are part of the member states’

¹²⁶ Part 3, no. 32, Letter to the Head of the Parliamentary Affairs Section of the Ministry of Foreign Affairs dated 6 September 1994 to the General Energy Policy Department of the Ministry of Economic Affairs, Professor Heringa’s Expert Opinion (**Exhibit RF-D1, HER-2**).

¹²⁷ Notice of the Ministry of Foreign Affairs dated 8 December 1994 to the PR EU Brussels (Permanent Representative of NL at the EU) document BZ 11.4 "Starting point: *The Netherlands finds it important that the Energy Charter Treaty will be signed on 17 December next. With regard to the decision-making regarding the provisional application, the following applies: Formulation as proposed by the Commission in point 6 of com 94 557 final has been approved, preferably with addition of the articles as mentioned in the advice of the Legal Department of the Council in jur.291/ener. 153. (...)*" Notice of the Ministry of Foreign Affairs dated 24 November 1994 to the PV EU Brussels BZ 11.7 (Professor Heringa’s Expert Opinion; **Exhibit RF-D1, HER-4**): "2 *The Netherlands considers provisional application of the ECT highly desirable. The Netherlands itself intends to commence with provisional application. The Community should do this as well. The Netherlands can therefore consent to the decision for provisional application – as stated in annex I – which the Council will make in due course. (...) Finally, the Netherlands can consent to the interpretative statement which the chairmanship has proposed in footnote 5.*" Part 3, no. 5, PV EU Brussels, subject: "16th partial report 1635e COREPER I, 14 December 1994" (R-352): "The new formal Council Resolutions for provisional application (docs. 12008/94 and 12012/94) are adopted, so that they can be handled as A-point at the Environmental Council of 15 December 1994."

¹²⁸ See also Writ, §§ 161 et seq., and SoR, §§ 86 et seq., which also elaborately discuss the manner in which the Tribunal handled the Joint EC Declaration.

jurisdiction.¹²⁹ It concerns a so-called "*mixed agreement*".¹³⁰ For this reason, the European Communities participated in the negotiations and signed the Treaty.¹³¹

114. The decision of the European Communities to provisionally apply the ECT was adopted during the meeting of the Council of the European Union of 15 and 16 December 1994.¹³² During this meeting, a joint declaration of the Council of the European Communities and the Commission of the European Communities and the twelve member states at the time was approved ("**Joint EC Statement**").¹³³ With regard to the interpretation of Article 45 ECT, this declaration reads that this provision does not impose any obligations that go further than what is compatible with the internal laws of the signatories:

“The Council, the Commission and the Member States agree on the following declaration: (...) Article 45(1) (...) does not create any commitment beyond what is compatible with the existing internal legal order of the Signatories (...)”¹³⁴

115. A statement of the European Commission to the Council of Europe and the European Parliament demonstrates that the Commission is of the opinion that the words “to the extent” mean the same as the words “for so far as”.

¹²⁹ See CJEU 16 May 2017, ECLI:EU:C:2017:376, §§ 290-293.

¹³⁰ See *Parliamentary Papers II*, 1995/96, 24545 (R 1560), 3, p. 18 for the exact delegation of authority between the Community and the member states. See also Writ, § 167 and SoR, § 89.

¹³¹ See C-2 and the signatures that are included at the end. See furthermore Statement submitted by the European Communities to the Secretariat of the Energy Charter pursuant to Article 26(3)(b)(ii) of the Energy Charter Treaty (OJ L 69/115 of 9 March 1998): "*The European Communities and their Member States have both concluded the Energy Charter Treaty and are thus internationally responsible for the fulfillment [sic.] of the obligations contained therein, in accordance with their respective competences.*"

¹³² Council of the European Union Approval of List "A" Items, Doc. 6418/95 (Apr. 7, 1995), 1 (R-353), concerning the approval of the Draft Minutes of the 1817th meeting of the Council (Environment) (December 15-16, 1994), Doc. 11980/94 (R-354), who in turn approve the "A" Items list including the "A" Item Note quoted below.

¹³³ "A" Item Note from the Permanent Representatives Committee to the Council of the European Union, Doc. 12165/94, Annex 1 (December 14, 1994), 3 (R-352). See also *Projet de Procès-Verbal*, 1817 Conseil PV stst11980ft94 (**Exhibit RF-247**), "2. *Approbation de la liste des points "A" doc. 11988/94 PTS A 67 + ADD 1 Le Conseil a approuvé les points "A" tels qu'ils figurent à la liste reprise au doc. 11988/94 PTS A 67 et son addendum 1.*" and Addendum 1 a la liste des points A, p. 2 no. 11. 1817 Conseil Pts A add (**Exhibit RF-248**), containing a reference to the Joint EC Declaration (no. 12165/94 ENER 161 EUROR 229 NIS 187).

¹³⁴ 1994 Joint EC Statement, (R-352) Unofficial translation from English: "*The Council, the Commission and the Member States agree on the following declaration: (...) Article 45(1) (...) does not create any commitment beyond what is compatible with the existing internal legal order of the Signatories (...)*". (emphasis added).

"The Treaty shall enter into force when thirty signatories will have ratified it. In the meantime, a provision on provisional application of the Treaty by the signatories is provided for insofar as [for sofar as] allowed by their constitution, laws or regulations."¹³⁵

116. In short: the European Communities, the Commission, the European Council and the then member states, including the Netherlands, are of the opinion that only provisions of the ECT that are compatible with national law will be provisionally applied.¹³⁶ This is consistent with the interpretation of the District Court.
117. Special weight should be attributed to the aforementioned documents in the interpretation of the ECT. After all, the ECT is part of European law. The European Court of Justice previously ruled in the *Dior* case that provisions in a mixed agreement (such as Article 45 ECT) must be interpreted by the member states and the judicial authorities in a uniform manner.¹³⁷ It would be inconsistent with EU law if an interpretation of Article 45 ECT would be accepted in these setting aside proceedings that is incompatible with the uniform interpretation of Article 45 ECT as jointly established by the European Communities and its member states.¹³⁸

¹³⁵ Proposal for a Decision of the Council concerning the signing of the Treaty regarding the European Energy Charter and the provisional application thereof by the European Community, COM/94/405DEF - CNS 94/021Z, Official Journal No. C 344 of 06/12/1994 page 0001. For the full text, see: European Commission, Communication from the Commission to the Council and the European Parliament on the signing and provisional application by the European Communities of the European Energy Charter Treaty, COM(94) 405 final (September 21, 1994), Annex 6, (**Exhibit RF-33**) (emphasis added).

¹³⁶ The Council of the European Union approved the text of the amendment to the trade related provisions of the Energy Charter Treaty on July 13, 1998 and described the (scope of the) provisional application as follows: "*Whereas since the day of its signature the Energy Charter Treaty has been applied, to the extent possible, on a provisional basis and will continue to be so applied to the extent possible, by those signatories who have not yet ratified the Treaty (...)*" Council Decision of July 13, 1998 approving the text of the amendment to the trade related provisions of the Energy Charter Treaty and its provisional application agreed by the Energy Charter Conference and the International Conference of the Signatories of the Energy Charter Treaty, 98/537/EC, L 252/21 (**Exhibit RF-34**) (emphasis added).

¹³⁷ CJEU 14 December 2000, case nos. C-300/98 and C-392/98, ECLI:EU:C:2000:688 (*Dior*), par. 37: "*Since Article 50 of the TRIPs is a procedural provision that must be similarly applied to all situations that fall within its scope, which situations can be both of a national-law and community-law nature, it is required for the performance of that obligation both for practical and legal reasons that the authorities of the member states and the Community interpret it in a uniform manner.*"

¹³⁸ HVY tried to enforce the Yukos Awards in France even after the said awards had been set aside. In response, a French court rendered an interim decision on 27 June 2017, suggesting to submit a request for a preliminary ruling to the ECJ about the interpretation of Article 45 ECT. After this interim decision was rendered, HVY withdrew the proceedings in France.

(d)(iii) *Representatives of many States, including the United States, Italy, the United Kingdom, Finland and Japan, agree with the District Court's interpretation*

118. As explained above, the interpretation of Article 45 ECT that is accepted by the District Court is in line with the different statements of representatives of the United States.¹³⁹ It is clear that the United States, Canada and Norway, when they made a first text proposal for Article 45(1) ECT, wanted to bring about that the provisional application would be limited to parts of the Treaty so that a conflict with national law would never arise.
119. At the time of the negotiations on the ECT, other states also made it clear that they are of the opinion that Article 45 ECT provides for a partial provisional application of the Treaty. Italy referred to the States that provisionally applied the Treaty based on Article 45(1) ECT as States “*who do apply provisionally at least some part of the treaty*”.¹⁴⁰
120. During the plenary negotiations, Japan indicated to other States that the text of Article 45 ECT¹⁴¹ entails that it will differ from country to country “*how much of this Treaty*” will be provisionally applied.¹⁴² Japan also stated this afterwards to the Secretariat in writing¹⁴³:

“According to the present draft, provisional application means to ‘apply provisionally to the extent that such provisional application is not inconsistent with laws and constitutional requirements.’ This, in other words, means that the extent to which this Treaty applies will differ from country to country according to their constitutions and legislations.” (emphasis added)¹⁴⁴

121. After signing the Treaty, government representatives continued to express the view that only part of the Treaty was to be applied provisionally. For example, the Finnish government clearly interpreted Article 45(1) ECT to contain the obligation to apply

¹³⁹ See §§ 87-92 above.

¹⁴⁰ See § 95 above.

¹⁴¹ Then: article 50 of the draft text.

¹⁴² Plenary session dated 14 December 1993, C-924, p. 3: “*Japan: (...) In addition to the reason given by the Norwegian delegation, we think this will create a very untransparent situation among the rights and obligations among signatory or Contracting Parties, because we see great variety in the domestic legislation of each signing countries, and each country doesn't know how much of this Treaty will be applied to each country.*”

¹⁴³ The far-reaching conclusions that HVY believe they can draw in SoD, §§ 332-334, based on a Japanese text proposal, are incorrect. See § 95 above.

¹⁴⁴ Writ, § 172. Letter from Japanese Mission to the European Communities to Energy Charter Secretariat (20 January 1994), 2 (R-843).

specific treaty provisions provisionally “*in so far as the provisions of the treaty are not inconsistent with the legislation of the signatories*”.¹⁴⁵

122. The Minister for Foreign Affairs of the United Kingdom made it clear to the House of Commons in 2006 that Article 45 ECT has as a result that a State (such as the Russian Federation) only takes on some obligations:

“The obligations of the Energy Charter Treaty (ECT) on a signatory depend on whether it has ratified the treaty, is applying provisionally or has opted out of provisional application. The Russian Federation has not ratified the Treaty but has agreed to provisional application in accordance with Article 45 of the Treaty. This places some obligations on the Russia [sic] Federation, but only to the extent that such provisional application is not inconsistent with its constitution, laws or regulations.”¹⁴⁶

(d)(iv) The Russian Federation made it clear that the scope of the provisional application was limited

123. HVY argue that the interpretation accepted by the District Court was allegedly “*made up*” by the Russian Federation after the Arbitrations had been initiated.¹⁴⁷ They even argue that the Russian Federation allegedly stated prior to the Arbitrations that it provisionally applied the Treaty *in its entirety*.¹⁴⁸ This is incorrect. Such a statement cannot be found in any of the documents cited by HVY.¹⁴⁹ That HVY's statements are totally unfounded is, at a glance, clear in the following overview.

¹⁴⁵ Writ., § 160 and SoR, § 85. Finnish Government Proposal to the Parliament regarding the ratification of the ECT, HE 46/1997, § 4.1 (**Exhibit RF-31**), (emphasis added by counsel). For more details, see Professor Talus's Expert Opinion, §§ 45 and 51-55 (**Exhibit RF-D11**).

¹⁴⁶ Writ, § 177. House of Commons Hansard Written Answers, pt. 3, column 1045 W *et seq.* (February 7, 2006), 1 (R-365) (emphasis added).

¹⁴⁷ See § 106 above.

¹⁴⁸ See SoA, §§ 3.2 and 3.3.

¹⁴⁹ In this context, see also Professor Nolte's 2017 Expert Opinion (**Exhibit RF-D2**), §§ 60-74, where these documents are discussed in detail. Most documents referred to by HVY are irrelevant; it only concerns short remarks which merely demonstrate that the Russian Federation has signed the Treaty and will consequently provisionally apply it based on Article 45 ECT. See SoA, § 161 (where a brief remark on a website is discussed), and SoA, § 165 (with reference to a statement for the benefit of a meeting of 17 and 18 December 2002). HVY have not cited even a single source wherein the Russian Federation stated that it provisionally applied the Treaty as a whole. The wording chosen by HVY is therefore always very careful. It comes down to the fact that the Russian Federation allegedly did not explicitly say that it has problems with the provisional application of the Treaty as a whole. See, for example, SoA, §§ 153-156. However, given the explicit text of Article 45 ECT, the provisional application of the Treaty as a whole was never the intention. HVY attempt, to no avail, to use such statements – such as a remark on a website – of the Russian Federation to argue that the Russian Federation can no longer rely on Article 45 ECT due to estoppel (see §§ 310 *et seq.* below). In the arbitration proceedings *Achmea v. Slovak Republic*, Achmea invoked estoppel and pointed out in that context that the official website of Slovakia wrongly

UNOFFICIAL TRANSLATION

This text is an unofficial translation of the Dutch original. In case of any discrepancies, the Dutch original shall prevail.

stated that an investment treaty was still in force. The Tribunal rejected Achmea's reliance on estoppel and considered in that respect that the Tribunal's competence could not be stretched on that ground. (*Achmea B.V. (formerly Eureko B.V.) v. The Slovak Republic*, PCA Case No. 2008-13, Award on Jurisdiction, Arbitrability and Suspension, 26 October 2010, §§ 61-63, 100-108, 219, available at: <https://www.pcacases.com/web/sendAttach/775>).

The Statement of Appeal's evident inaccuracies

During the negotiations about the ECT the Russian Federation provided "Annex A" and "Annex T" lists several times which demonstrate that more than twenty specific Russian laws are an impediment for the treaty obligations of the ECT (DoA, § 320).

In a memorandum dated 8 July 1997, the Russian Federation made it clear for the benefit of a plenary meeting of the ECT Conference that in each separate case an analysis must be made of the exact scope of the provisional application (DoA, § 125).

The Explanatory Memorandum regarding the proposal to enforce the ECT from 1996 confirms that the ECT adopts rules that deviate from existing legislation

During the parliamentary debate of the ECT in 2001 the parliament noted that the ECT is in breach of existing Russian legislation (DoA, § 316).

The Russian Federation confirms in a report that it offered to the ECT Secretariat in 2004 that the Treaty provides for provisional application, but only insofar as this is not in breach of legislation of separate signatories (DoA, § 128).

The conclusions of the Duma on 26 January 2001 were as follows (C-156, p. 60):

The ECT's entry into force will have the following positive consequences:

- it will grant Russia additional opportunities to resolve disputes on an international level on issues of the transit of Russian energy resources and foreign investments;

Mr Ter-Sarkisyants indicated during the case hearing in the Duma on 26 January 2001 (C-156, p. 75):

First of all, I would like to state that we support the ratification of the Treaty. From the point of view of oil transportation and transit this decision has been thoroughly thought through. Let me emphasize that we are talking about oil transit here. In our work, we routinely have to face purely practical issues that have to be addressed. The notorious tariff issues for transit across Ukraine and gas offtake in Ukraine. We believe that these issues could be resolved through a mechanism provided by the Energy Charter, rather than by means of useless negotiations. For example, the Friendship project was suspended just for this reason, and there are no available mechanisms for its resolution at present. We contacted the Secretariat of the Charter on this issue. We received an official written response: "Dear colleagues, we admit that Ukraine is acting improperly and that its acts contradict both the spirit and letter of the Energy Charter, the Protocol, and the Treaty; however, we cannot consider this matter now because you have not ratified the Charter ." That is it, and the issue was closed.

Explanatory Memorandum of the legislative proposal of the ECT (C-143)

Prior to the entry into force of the ECT, the majority of the Contracting Parties agreed to apply the treaty on a provisional basis. In this respect, it was decided that such provisional application of the ECT would be implemented to the extent that it would not be inconsistent with the constitution, laws and regulations of the country in question.

The ECT contains a number of legally binding provisions, based on the GATT provisions, that have yet to be reflected (or fully reflected) in the Russian legislation. This concerns the provisions relating to customs duties; protective and anti-dumping measures; duties with regard to the export and import of goods; subsidies; state enterprises; implementation of technical norms and standards; etc.

Memorandum of the Russian Federation to the ECT Secretariat and other States dated 8 July 1997 (C-925)

Provisional application means putting the treaty into effect, applying its provisions in reality i.e. performing actions foreseen in the treaty to the extent provided for in the treaty

Analysis of provisional (till entry into force) application of international treaties by the Russian Federation shows that in each specific case a detailed study of the legal scope of provisional application of the treaty is necessary.

HVY Statement of Appeal:

178. In brief, the Russian Federation itself repeatedly and unambiguously concluded and confirmed that the provisions of the ECT, therefore including Article 26 ECT, were fully consistent with its national laws. It follows from the above that the Russian Federation considered itself provisionally bound to the ECT and all of its provisions, including the arbitration clause of Article 26 ECT. **Not only did the Russian Federation make this apparent directly to its treaty partners,** for example by communications in the context of the ECT, but also to the investors of these treaty partners, for example by announcements on the website of its Ministry of Foreign Affairs and **in official public documents.**

180. However, the Russian Federation has not managed to mention a single authority dating from before HVY initiated the Arbitrations that corroborates that the full provisional application of the ECT in the Russian Federation had ever been in doubt. The Russian Federation has apparently not been able to come up with a single member of parliament, **government official, politician,** legal scholar, economist, expert in the field of foreign policy, or in whatever other field, who ever questioned **the full provisional application of the ECT,** or Article 26 in particular.

The Russian Federation now asserts that arbitration pursuant to Article 26 ECT is inconsistent with its 1993 Constitution, other laws of the Russian Federation, and all sorts of unwritten principles of Russian law. If there were really so many and such fundamental defects inherent in the provisional application of Article 26 ECT, it is incomprehensible that nobody pointed this out at the time, **not even during discussions in the State Duma.**

At the time of the ECT's formulation, the Russian government members made a conscious decision to use wording that makes it clear that the Treaty would be partially provisionally applied (DoA, § 124).

The State Duma emphasized in the parliamentary debate in 1997 that there are conflicts between specific treaty provisions and the federal laws (DoA, § 322).

The defects in the provisional application of Article 26 ECT were specifically addressed during the parliamentary debate in 2001 (DoA, § 152).

During the oral hearing in the Duma on 17 June 1997, Professor Bystrov expressed concerns about the fact that Article 26 ECT would affect the immunity of the Russian Federation. If parliament wanted to adhere to the existing system, a provision to the Treaty had to be created (DoA, § 152).

124. In reality, the Russian Federation repeatedly indicated prior to the Arbitrations that the scope of the provisional application based on Article 45 ECT was limited. During the formation of the Russian text, four high-ranking members of the Russian government deliberately agreed to use wording that makes it clear that parts of the Treaty would be provisionally applied. A suggestion to translate the words “to the extent” as “if” was rejected (see § 100 above). The Russian authentic text was then approved by the entire Conference.
125. In a memorandum dated 8 July 1997 for the benefit of a plenary hearing of the ECT Conference, the Russian Federation clarified its legislation regarding provisional application.¹⁵⁰ It is emphasized in the memorandum that the scope of the provisional application is determined by the treaty itself.¹⁵¹ This memorandum also indicates that there is an important distinction between provisional application on the one hand and the implementation of a treaty that has entered into force on the other hand. The Russian Federation makes it clear in this memorandum that an analysis of the exact scope of the provisional application must be made in each specific case:

“The analysis shows that provisional application until entry into force and implementation of the treaty is not the same. (...)

Analysis of provisional (till entry into force) application of international treaties by the Russian Federation shows that in each specific case an extensive study of the scope of provisional application of the treaty is necessary.”¹⁵²

126. Since the memorandum was written in view of the ECT, there cannot be any doubt about the fact that the Russian Federation confirmed shortly after signing (again) that the scope of the provisional application based on Article 45(1) ECT was limited.¹⁵³

¹⁵⁰ According HVY, the Russian Federation did not give “any indication” in the memorandum that the provisional application of the ECT would be limited in any way (see SoA, § 164). That statement is incorrect.

¹⁵¹ Memorandum of 8 July 1997, C-925. Original English text: “*Provisional application means putting the treaty into effect, applying its provisions in reality i.e. performing actions foreseen in the treaty to the extent provided for in the treaty.*”

¹⁵² Memorandum of 8 July 1997, C-925. English translation of the original Russian text.

¹⁵³ As Professor Stern indicated in her dissenting opinion, the wording employed in this note confirms the position of the Russian Federation: “*confirms the understanding by the Russian authorities that provisional application of a treaty was different from implementation of a treaty in force. It also suggests that one has to look at the different provisions of the treaty (‘a detailed study of the legal scope of provisional application’) to see which rules are and which rules are not consistent with the Russian legal*

127. The Russian Federation also repeatedly indicated in other official documents that it would only provisionally apply the Treaty to the extent that this is not inconsistent with its own legislation. See, for example, the Explanatory Memorandum, which was drawn up by the government in view of the approval of the ECT by the Duma.

“Prior to the entry into force of the ECT, the majority of the Contracting Parties agreed to apply the treaty on a provisional basis. In this respect, it was decided that such provisional application of the ECT would be implemented to the extent that it would not be inconsistent with the constitution, laws and regulations of the country in question.”¹⁵⁴

128. In this context, please see a report of the Minister of Energy of the Russian Federation offered to the ECT Secretariat in 2004.¹⁵⁵ In the foreword of the report, the Russian Federation makes it clear that while it has signed the Treaty, the Duma has not ratified it for substantive reasons. The Russian Federation confirms that the Treaty provides for provisional application, but only insofar as this is not inconsistent with the legislation of the separate signatories.¹⁵⁶

129. The fact that the scope of the provisional application was limited was discussed during the public hearing of the Treaty in the Russian Parliament. Professor Yershov, the chairman of the Russian delegation who was negotiating on the ECT submitted a report to the Duma. In that report, Yershov clarifies that the scope of the provisional application of the treaty was limited. He points out that "*under the terms of the ECT, such provisional application is*

order." *Yukos Capital S.à r.l. (Luxembourg) v. The Russian Federation*, PCA Case No. 2013-31, Interim Award on Jurisdiction, 18 January 2017, Dissenting Opinion of Professor Brigitte Stern, § 76.

¹⁵⁴ Explanatory Memorandum, C-143, p. 1, English translation of the original Russian text.

¹⁵⁵ SoA, §§ 167 et seq. and C-8.

¹⁵⁶ Russian Federation, Investment Climate and Market Structure in the Energy Sector (C-008), p. 5.

English translation of the original Russian text:

"FOREWORD

The Russian Federation (RF) signed the Energy Charter Treaty (ECT) on December 17, 1994. The Russian Federation agreed to apply the ECT on a provisional basis pending its ratification by RF. Under the ECT such a provisional application is possible to the extent that it is not inconsistent with the constitution, laws or regulations of the relevant country.

The Government of the Russian Federation presented the ECT to the State Duma for ratification on August 26, 1996 but the Treaty has not been ratified yet. The reasons for nonratification of the ECT include, inter alia, dissatisfaction with the results of the ongoing negotiations on the ECT Transit Protocol and lack of initiative on the part of the Energy Charter Conference governing bodies with a view to developing a number of new protocols. In particular, it concerns a gas protocol, which would facilitate resolution of investment problems that producers face in connection with the gas market liberalisation policies in the West European countries."

*made to the extent that such provisional application is not inconsistent with [the respective country's] constitution, laws or regulations".*¹⁵⁷ The other conclusions which HVY connect to Professor Yershov's report¹⁵⁸ were therefore rightly rejected by the District Court.¹⁵⁹

(d)(v) *The District Court's interpretation corresponds with the interpretation of the individuals that were involved in the ECT negotiations*

130. The treaty interpretation accepted by the District Court furthermore entirely corresponds with the interpretation of the most important advisers and negotiators involved in the conclusion of the ECT.
131. Mr Sydney Fremantle was the highest British government official involved in the conclusion of the ECT. He was the chairman of the working group that had drawn up the first draft of the ECT.¹⁶⁰ Mr Fremantle argues that Article 45 ECT was intended to cover inconsistencies between specific treaty provisions and national law.¹⁶¹ As early as August 1994, he sent a fax message to ambassador Rutten, the chairman of the plenary meeting, wherein he pointed out that the arbitration clauses of the Treaty would probably not be applied provisionally.¹⁶²
132. Ms Lise Weis¹⁶³ and Mr Craig Bamberger were closely involved in the conclusion of the ECT as legal advisers of the ECT Secretariat. On 10 November 1994, Ms Weis sent a fax

¹⁵⁷ See Yershov's document, C-153, § 1.7, p. 24.

¹⁵⁸ HVY believe that the report implies that the entire ECT, or in any case Article 26 ECT, is compatible with Russian law. HVY write that Yershov draws a conclusion further to an "analysis" wherein he allegedly discusses Article 26 ECT "in detail" (see SoD, § II.206, SoRej., § 89, and SoA, §§ 175-176). However, that conclusion does not follow from the report (see also SoR, § 118). If one looks at Yershov's report, it becomes clear that Yershov merely indicates in an introductory paragraph that once the ECT has entered into force, no further concessions are required that could not be placed in the current legal framework (see the wording "(...) under the ECT"). The quote is in no way related to Article 26 ECT, a provision that is only briefly touched upon in the closing paragraphs of Yershov's text. See also Professor Nolte's 2017 Expert Opinion (**Exhibit RF-D2**), §§ 60-74.

¹⁵⁹ Judgment, ground 5.61.

¹⁶⁰ Writ, §§ 176 and 190, SoR, § 107.

¹⁶¹ Fremantle's expert opinion, Opinion concerning the provisional application of the Energy Charter Treaty, 21 January 2007 ("**Fremantle's Expert Opinion**", submitted in the Arbitrations, **Exhibit RF-03.1.C-1.3.3**), §§ 32-52.

¹⁶² See Annex A to Fremantle's Expert Opinion (**Exhibit RF-03.1.C-1.3.3**): "*most national and sub-national laws provide for disputes under those laws to go to the local courts, not through international arbitration unless there is a special provision.*" See also Fremantle's Expert Opinion, § 34: "*expected that few if any States would be applying the arbitration articles provisionally.*" See also § 146 below.

¹⁶³ Lise Weis worked at the Energy Charter Conference Secretariat. She participated in most meetings of the Legal Sub Committee.

to Mr Bamberger regarding the interpretation of Article 45 ECT. According to Ms Weis, the words “to the extent” mean that parts of the Treaty will be provisionally applied, even if other parts cannot be applied (emphasized as in the original):

“Craig,

Re: Provisional Application, Article 45(1), (2)(a) and (2)(b)

1. Article 45(1) states that each signatory agrees to apply the Treaty provisionally to the extent not inconsistent with its constitution, laws or regulations.

To me, this language carries the notion that each signatory will make an effort to apply the Treaty provisionally. Furthermore, the expression ‘to the extent’ implies that the signatory will apply certain parts of the Treaty provisionally even if it is unable to apply other parts. The actual extent of provisional application for each signatory will, however, not be clear to the other signatories. (...)”¹⁶⁴

133. Mr Bamberger was the chairman of the legal advisory committee of the Conference on the European Energy Charter.¹⁶⁵ Mr Bamberger’s writings on Article 45 ECT demonstrate that he assumes that States would provisionally apply parts of the Treaty.¹⁶⁶ According to Bamberger, the provisional application of the arbitration provisions would be “especially problematical”.¹⁶⁷ It is telling that HVY hired Mr Bamberger as an expert, but ultimately have not submitted an expert opinion drafted by him on the backgrounds and interpretation of Article 45 ECT.¹⁶⁸
134. Finally, Mr Martynov, who participated in the negotiations on the ECT on behalf of the Russian Federation, confirmed that Article 45 ECT provides for the provisional application of parts of the Treaty. According to Mr Martynov, it was clear at the time that “*Russia*

¹⁶⁴ Fax from Lise Weis to Craig Bamberger dated 10 November 1994, Re: provisional application, (**Exhibit RF-249**).

¹⁶⁵ See also §§ 99 and 147 of this SoD. See Writ, §§ 173 and 179-183.

¹⁶⁶ See, *inter alia*, his statement during the negotiations on the ECT. Session of March 7, 1994 (Mr Craig Bamberger), 11-12 (C-924): “*the effect is to suggest that relatively minor impediments in the form of regulations, no matter how insignificant they may be, can be the occasion for failing to apply the Treaty provisionally when in fact those regulations could be brought into conformity without serious effort.*” See also C. S. Bamberger, Epilogue: The Energy Charter Treaty As A Work In Progress, in *The Energy Charter Treaty – An East-West Gateway for Investment and Trade* (T. Wälde, ed. 1996), 602.

¹⁶⁷ C.S. Bamberger, *Adjudicatory Aspects of Transit Dispute Conciliation Under The Energy Charter Treaty*, 3 TDM (April 2006), 16 (R-866): “*may be especially problematical as concerns the acceptance of legally binding resolution in an international forum of disputes over domestic matters.*”

¹⁶⁸ Writ, § 183, and SoR, §§ 107-109.

would not be able to provisionally apply the provisions in the ECT that concern dispute resolution by means of international arbitration.”¹⁶⁹

(d)(vi) *The District Court's interpretation corresponds with the interpretation that is generally accepted in legal literature*

135. The District Court's interpretation of Article 45 ECT is in line with international literature that had appeared before the Arbitrations commenced.¹⁷⁰ For example, Dr René Lefeber (Vrije Universiteit Amsterdam) already wrote in 1998 that Article 45 ECT means that the obligations that arise under international law depend on the content of national law:

“A treaty may, of course, put limits to its own provisional application. Thus, a treaty may provide that its provisional application is subject to national law which means that, in case of conflict, national law prevails over the treaty. The 1994 ECT, for example, provides that it is to be applied provisionally by a state ‘to the extent that such provisional application is not inconsistent with its constitution, laws or regulations’ (Art. 45(1)).”¹⁷¹

136. In his 2011 doctoral thesis, Mr Pritzkow remarks that the all-or-nothing-interpretation proposed by HVY and accepted by the Tribunal was never discussed prior to the Arbitrations.¹⁷² It was not until after the Arbitrations had been initiated that articles appeared wherein this interpretation was discussed. For example, Ms Banifatemi, one of HVY's lawyers, wrote a chapter in a handbook in which she argued that the principles of

¹⁶⁹ A. Martynov, Opinion Concerning Provisional Application of the Energy Charter Treaty (December 14, 2006) ("**Martynov's Expert Opinion**") (submitted in the Arbitrations, **Exhibit RF-03.1.C-1.3.6**), §§ 4-6.

¹⁷⁰ Fawcett already wrote in 1953 that the parties can limit the scope and effect of a Treaty. James Fawcett, 'The Legal Character of International Agreements', 50 BYIL 381, p. 390-91 (1953) (R-396): "*Certain provisions in international agreements appear to negative any intention to create legal relations. These are provisions which in one way or another leave it to the parties themselves to determine the extent to the obligations they have assumed and the mode of performance. For example, an undertaking qualified by the words 'subject to the law in force' would, if it is submitted, create no international obligation at all; for it would enable any party to appeal successfully to municipal law against any attempt by another party to enforce the obligation.*"

¹⁷¹ René Lefeber, The Provisional Application Of Treaties, in: Essays On The Law Of Treaties: A Collection Of Essays In Honour Of Bert Vierdag (Jan Klabbers and René Lefeber, eds. 1998), 89 (**Exhibit RF-27**) as referred to in the SoR, § 101.

¹⁷² S. Pritzkow, *Das völkerrechtliche Verhältnis zwischen der EU und Russland im Energiesektor*, Springer, 2011, p.62 (**Exhibit RF-230**), translation of the original text: "*The Ad-hoc Tribunal in the Yukos proceedings proposed a – previously never discussed – all-or-nothing interpretation as regards this standard. (...) However, this interpretation of Article 45(1) ECT should be rejected.*" Original text: "*Das Ad-hoc-Tribunal in de Jukos-Fällen hat hinsichtlich dieser Norm einen – zuvor niemals diskutierten – All-or-Nothing-Approach vertreten. (...) Dieses Verständnis des Art. 45 Abs. 1 ECT ist allerdings abzulehnen.*"

transparency and reciprocity were of great importance in the formation of Article 45 ECT.¹⁷³

137. The interpretation of Article 45 ECT that is accepted by the Tribunal has been very critically received in legal literature.¹⁷⁴ For example, Messrs Thomas Roe and Matthew Happold believe the Tribunal's interpretation to be "far from logical".¹⁷⁵ Mr Tarcisio

¹⁷³ Yas Banifatemi, "Provisional application of the Energy Charter Treaty: the negotiation history of Article 45" in Graham Coop (ed.) *Energy Dispute Resolution: Investment Protection, Transit and the Energy Charter Treaty*, 2011, pp. 192-210 (**Exhibit RF-250**). Incidentally, the article was criticized in the introduction of the specific part of the manual by Professor Crawford: "*Ms. Banifatemi places particular emphasis on the principle of transparency and accountability which she considers an underlying theme of the negotiations. The Yukos tribunal did not seem to follow this line of reasoning however, noting 'the distinction which must be made between what may have been said to be desirable during the negotiations and what, eventually, became legally required in the Treaty.'*" James Crawford, Introductory Remarks, in: Graham Coop (ed.) *Energy Dispute Resolution: Investment Protection, Transit and the Energy Charter Treaty*, 2011, p. 188 (**Exhibit RF-251**). See also SoR, §§ 208 et seq., which demonstrates that Banifatemi's interpretation of the law should not be followed.

¹⁷⁴ In this context, see the aforementioned very extensive doctoral thesis S. Pritzkow, *Das völkerrechtliche Verhältnis zwischen der EU und Russland im Energiesektor*, Springer, 2011, pp. 62 et seq. (**Exhibit RF-230**). U. Klaus, "The Gate to Arbitration, The Yukos Case and the Provisional Application of the Energy Charter Treaty in the Russian Federation" *Transnational Dispute Management* 2005, Vol 2(3) (**Exhibit RF-252**): "*The second interpretation seems more plausible; the purposes of a limitation in provisional application, as in Art. 45 (1) ECT, is to avoid possible internal conflicts between the treaty's provisions and national regulations during a transitional period. A check of national law only with regards to its consistency with the legal concept of provisional application would be insufficient to achieve this aim. Therefore in the author's view, the concept of provisional application as well as the substantial provisions must be consistent with national regulations.*" A. Quast Mertsch, *Provisionally Applied Treaties: Their Binding Force and Legal Nature*, 2012, (**Exhibit RF-121**), p. 208, footnote 151: "*The extent to which the ECT is provisionally applied varies. According to the first option, the ECT as a whole is provisionally applied (Article 45(1)), yet due to the limitation clause the actual extent to which this is done may vary from signatory to signatory (since a signatory agrees to apply the ECT provisionally 'to the extent that such provisional application is not inconsistent with its constitution, laws or regulations').*" (emphasis added). T. Gazzini, 'Yukos Universal Limited (Isle of Man) v. The Russian Federation, Provisional Application of the ECT in the Yukos Case' *ICSID Review*, Vol. 30, No. 2 (2015) p. 293-302, p. 301. (**Exhibit RF-232**): "*The crucial finding of the Award, namely that the limitation clause under Article 45(1) relates to the compatibility in principle of the whole ECT with domestic law, on the contrary, is not convincing. The Tribunal seems to have neglected several important literal elements and read far too much into the word 'such'. The choice to take into account only the English version of the ECT, moreover, is questionable as the other equally authentic version could have displayed useful indications. Perhaps most importantly, the Tribunal failed to explain the reasons why it reduced the compatibility test under Article 45(1) to a matter of principle.*"

¹⁷⁵ Thomas Roe and Matthew Happold, *Settlement of Investment Disputes under the Energy Charter Treaty*, Cambridge 2011, p. 76 (**Exhibit RF-253**): "*(...) it is not at all obvious why a state which agrees to apply 'the entire Treaty' provisionally, but only 'to the extent that such provisional application [of the entire Treaty] is not inconsistent with its constitution, laws or regulations' must thereby be taken to have agreed to apply the entire Treaty provisionally unless provisional application of the entire Treaty is impermissible in principle under its constitution, or under a law or (improbably, as Russia pointed out) a regulation.*"

Gazzini qualified the Tribunal's interpretation as "underdeveloped" and "superficial".¹⁷⁶ In this context, we refer to an article of Professor Reisman. In the Arbitrations, he defended HVY's position as an expert, without actually discussing the words "to the extent" in detail.¹⁷⁷ Later however, Professor Reisman observed in an academic article that the explanation advocated by HVY deprives the words "to the extent" of their meaning and makes these words redundant:

"If Article 45(1) had been intended to refer to the notion of the permissibility of the provisional application of a treaty as such, it would not have been necessary to introduce the phrase 'to the extent'. Domestic law either permits or does not permit provisional application of treaties; there would be no function for the words 'to the extent'. If the intention in Article 45(1) had been to refer to permissibility of provisional application of a treaty as such, the phrase, 'to the extent', would have been replaced with words such as 'if' or 'where'. The phrase, 'to the extent', is meaningful only if it refers to the various obligations in the ECT." (emphasis added)¹⁷⁸

(e) *The Tribunal's interpretation of the treaty leads to absurd consequences*

138. The position of HVY leads to the conclusion that virtually all signatories of the ECT should provisionally apply the Treaty as a whole. If this opinion is followed, the States should also implement separate provisions of the ECT that are inconsistent with national legislation. This interpretation is diametrically opposed to the interpretation the United States had in mind when it proposed a first wording for the Limitation Clause in 1991.
139. In HVY's opinion, Minister Wijers, who signed the Treaty on behalf of the Netherlands¹⁷⁹, apparently acted in breach of Dutch legislation and the Constitution. After all, the Dutch Government is not authorized to declare a treaty that deviates from formal laws to be provisionally applicable. It beyond dispute that the ECT deviates from existing Dutch

¹⁷⁶ T. Gazzini, *Interpretation of International Treaties*, Hart Publishing 2016, p. 71 (**Exhibit RF-233**): Original English text: "*The Yukos v Russian Federation case provides an example of underdeveloped or superficial literal analysis.*"

¹⁷⁷ See Professor Reisman's expert opinion as submitted in the Arbitrations in the jurisdiction phase.

¹⁷⁸ M. H. Arsanjani and W. M. Reisman, Provisional Application of Treaties in International Law: The Energy Charter Treaty Awards, in *The Law of Treaties Beyond the Vienna Convention* (2011), 92 (Exhibit RF-21).

¹⁷⁹ See the letter regarding the signing of the Treaty by the Kingdom of the Netherlands dated 13 December 1994 (**Exhibit RF-254**).

legislation with regard to numerous important points, including the far-reaching arrangements on arbitration.¹⁸⁰

140. HVY's all-or-nothing interpretation also implies that countless other governments that signed acted in breach of their own laws and constitution.¹⁸¹ The submitted expert opinions demonstrate that in that case they would have violated their own powers.¹⁸² The treaty interpretation proposed by HVY therefore leads to the absurd conclusion that the governments of, inter alia, the Netherlands, France, and the Russian Federation all acted in violation of their own laws and constitutions by signing the ECT.

C. The District Court correctly found that arbitration of HVY's claims is inconsistent with the Russian Constitution and Russian laws

The Russian Federation refers to:		
<u>Arbitrations:</u>		
HEL Interim Award	Chapter VIII.A.4.c	marginal nos. 106-179, 234-293
<u>Setting aside proceedings:</u>		
Writ	Chapter IV.C.c	§§ 187-244
SoD	Part II, Chapter 2.1.3	§§ 191-266
SoR	Chapter III.C.d	§§ 111-185
SoRej	Chapter 2.2.3	§§ 75-125
RF Pleading Notes	Chapter III.2	§§ 16-18
HVY Pleading Notes	Chapter 1.2.1	§§ 32-45
SoA	Part I, Chapter 6	§§ 540-604
<u>Primary exhibits:</u>		
<u>Arbitrations:</u>		
Fremantle Opinion Annex A	Fax demonstrating that the expectation is that not a single state will provisionally apply Article 26 ECT	
R-866	Mr Craig Bamberger expected that the provisional application of Article 26 ECT would be problematic	
<u>Setting aside proceedings:</u>		
RF-51-RF-61	Treaties demonstrating a consistent and very conservative policy towards arbitration on the part of the Russian Federation	

¹⁸⁰ See Professor Heringa's Expert Opinion, § 22: "*This conclusion also excludes that in case of provisional application binding arbitrations are created or legal regimes are otherwise created that deviate from the constitutional rules on jurisdiction, the right to access to the court and the existing rules of legal action.*"

¹⁸¹ See also Writ, § 158, and the Russian Federation's Plea Notes dated 9 February 2016, § 25.

¹⁸² See, *inter alia*, with regard to France and Finland: Professor Pellet's 2006 Expert Opinion (**Exhibit RF-03.1.C-1.3.9**), §§ 23-27 and 37, Professor Nouvel's Expert Opinion (**Exhibit RF-D10**), §§ 98-100, Koskeniemi's Expert Opinion (**Exhibit RF-03.1.C-1.3.4**), §§ 23-24, Professor Talus's Expert Opinion (**Exhibit RF-D11**), § 53. See Writ, §§ 158 et seq., Professor Nolte's 2006 Expert Opinion (**Exhibit RF-03.1.C-1.3.7**), §§ 29-38 and 65, and Professor Nolte's 2016 Expert Opinion (**Exhibit RF-D12**), § 72, original English text: "*If the terms of the ECT were such that the German government considered that it was required to commit to provisionally apply the ECT in its entirety, the German government would have been constitutionally unable to commit, by its signature, to such provisional application.*"

RF-256-RF-263

Travaux préparatoires, showing that arbitrations was a controversial treaty provision during the ECT negotiations**Essence of the reasoning**

- The arbitration clause in Article 26 ECT violates the sovereignty and immunity of States. At the time of the negotiations, Article 26 ECT was one of the most controversial treaty provisions. It was presumed at the time that “*few if any States would be applying the arbitration articles provisionally*” (see § 143-147).
- It was generally known at the time of the negotiations that the Russian Federation – like other Eastern European States – has a long tradition of and consistent treaty practice in exercising great restraint with respect to national and international arbitration (see § 148-153).
- In the Arbitration the Russian Federation has advanced three independent arguments on the basis of which arbitration of the present dispute is inconsistent with Russian law.

(a) **Introduction**

141. As explained above, the District Court rightly found that the Russian Federation “*was only bound by the Treaty Provisions that are consistent with Russian law.*” The next question is whether arbitration of HVY’s claims pursuant to Article 26 ECT “*is inconsistent with (...) [the] constitution, laws or regulations*” of the Russian Federation.
142. During the negotiations on the ECT, multiple States expressed their objections to the proposed arbitration arrangement, as the arbitration clause in Article 26 ECT is a far-reaching treaty provision. This treaty provision violates the sovereignty and immunity of States.¹⁸³
143. The United States of America considered it undesirable that disputes concerning taxation measures of the separate States could be submitted to arbitrators.¹⁸⁴ It believed that the

¹⁸³ See Professor Nolte’s 2006 Expert Opinion (**Exhibit RF-03.1.C-1.3.7**), §§ 23, 39 and the literature cited there.

¹⁸⁴ See the letter from A. Larson (USA) to Mr Rutten (Chairman) dated 28 July 1994 (**Exhibit RF-255**). See, for example, the letter from Fremantle to Chairman Rutten dated 2 August 1994 on the sovereignty of the United States of America regarding tax disputes (**Exhibit RF-256**): “*Indeed the terms of the proposed unilateral declaration on Article 24 [in the final version: Article 26 ECT] lead to conclusion that the provisions of the ECT will apply to the sub-federal entities through the US legal system. Accordingly the*

Treaty would never be ratified by their Senate for that reason. This was why representatives of the United States chose to announce at an early stage that they could not consent to the text.¹⁸⁵ During a press conference on 13 October 1994, the American ambassador explained this decision as follows:

“This [Energy Charter Treaty] draft text subjects our states' tax policies, for example, to a dispute settlement process that would give foreign investors a privileged forum in which to challenge those tax policies – over and above what domestic companies might have. We have to make certain that our states' prerogatives are protected. Quite frankly, it would be from our perspective counterproductive to present to the Senate a treaty which we know in advance, because of this provision, will simply not be ratified.”¹⁸⁶

144. Other states also expressed objections to the arbitration scheme. For example, Canada believed that tax disputes should not be arbitrated.¹⁸⁷ Norway indicated that it wanted a reservation on the whole arbitration article for constitutional reasons.¹⁸⁸ During the plenary negotiations, Norway indicated that the arbitration clause entails a waiver of state sovereignty. In such a case, the Norwegian Constitution requires the approval of the Treaty

US sub-federal concern cannot be in relation to the substance of Article 24 but only to the dispute resolution procedures. The EU has accepted that there is no problem in substance regarding US sub-federal tax measures. It is therefore sufficient to answer to the US difficulties on Article 24 if we can provide a mechanism under which they can avoid international arbitration on disputed sub-federal tax measures and instead rely on their own federal and state courts.”

¹⁸⁵ See the fax from Mr Larson (USA) to Mr Rutten (Chairman) dated 2 September 1994 (**Exhibit RF-257**), Letter from Mr S. Donnaly (USA) to Mr Rutten (ECT Chairman) dated 7 September 1994 (**Exhibit RF-258**): “We have made a quick review of your proposed Understandings with respect to Articles 24/26 and 50 and regretfully have concluded that such an approach would not meet U.S. concerns. Our position remains as conveyed in Ambassador Larson's September 2 letter; we believe that our proposals of July 28 constitute a fair and constructive solution. It is essential that the first ECT adequately address U.S. needs for subfederal exceptions and exclude U.S. subfederal taxation measures. Your proposal would not do this; it would bind the U.S. subfederal authorities to the obligations of Articles 24 and 26 without exception.”

¹⁸⁶ Press release by Ambassador Eizenstat dated 13 October 1994 (**Exhibit RF-259**).

¹⁸⁷ Letter from the Canadian delegation to the Energy Charter Conference Secretariat dated 19 March 1992 (**Exhibit RF-260**): “Canada cannot agree that disputes regarding tax matters be referred to an arbitral tribunal nor that they can be discussed through diplomatic channels”. For more on this, see also BA-13 Basic Agreement, 19 June 1992, Article 23, General comment (R-849): “CDN cannot agree that disputes regarding tax matters be referred to an international tribunal. (...)”. The same comment can be found in later versions, too.

¹⁸⁸ BA-35 Basic Agreement 9 February 1993, Article 23, Specific comments, 23.1 (**Exhibit RF-261**): “23.1 N general reservation on the whole Article. N reserve involves Constitutional matters (...)” For a similar text, see also the later versions such as BA-37 and CONF 56, Draft ECT – Second version, 1 May 1993.

- by a 3/4 majority, which would be politically infeasible.¹⁸⁹ Canada and Norway neither applied the Treaty provisionally nor ratified the Treaty.¹⁹⁰
145. During the (heated) negotiations, the European Commission indicated that none of its member states were very pleased about the proposed arbitration provision.¹⁹¹ Moreover, several States separately indicated that the arbitration clause would present them with “*constitutional difficulties*”.¹⁹² For example, Italy indicated that its Constitution precludes the provisional application of treaties containing such arbitration clauses.¹⁹³ It is explained in the Arbitrations and in these Setting Aside Proceedings that the provisional application of Article 26 ECT is also at odds with the national laws of France, Finland and Germany.¹⁹⁴
146. Mr Fremantle stated that, at the time, he “*expected that few if any States would be applying the arbitration articles provisionally*”.¹⁹⁵ He also communicated this to the chairman of the ECT Conference by fax at the time. Mr Fremantle wrote that, in most jurisdictions, statutory regulations provide that, in principle, investment disputes may only be submitted

¹⁸⁹ Plenary, 25 May 1993, Audio file M25051993EN1_6, minute 10-22.

¹⁹⁰ Canada never signed the Treaty. Norway signed the ECT and issued a statement within the meaning of Article 45(2) ECT. Norway never ratified the Treaty thereafter.

¹⁹¹ Memorandum (IEA/OLC(93)26 from Bamberger to Steeg & Ferriter on negotiations of 1-6 February 1993. Summary of status on dispute resolution (including investor-state) treaty text. (**Exhibit RF-262**): “*The EC Commission said it had no firm position On Article 23 as yet, but that none of its members was very happy with it. Norway objected most strenuously to the article, submitting objections so sweeping that Fremantle declined to address them individually and said he would refer them collectively to the Plenary.*”

¹⁹² Report of working group 2 Basic Agreement 21-27 February 1993, p. 8 (**Exhibit RF-263**), Request made under the Dutch Government Information (Public Access) Act (*Wob*), Part 4, no. 4[b]): “*(...) [state] furthermore pointed to problems that had apparently also arisen during the EEA negotiations with respect to international arbitration, which [state] claims would present not only [state] but also [state 2] with constitutional difficulties for article 23.*” In this connection, see Norway’s aforementioned comments (see § 141).

¹⁹³ See the letter dated 27 June 1994 to the ECT Secretariat (C-905): “*Italy cannot consent to the provisional application of the Treaty since Article 80 of the Italian Constitution lays down, inter alia, that international treaties which provide for arbitration, confer judicial powers or impose financial burdens must be ratified by Parliament.*” Article 80 of the Italian Constitution provides (original English text): “*Art. 80 Parliament shall authorise by law the ratification of such international treaties as have a political nature, require arbitration or a legal settlement, entail change of borders, spending or new legislation.*”

¹⁹⁴ Professor Pellet’s 2006 Expert Opinion (**Exhibit RF-03.1.C-1.3.9**), §§ 33-36, Professor Nouvel’s Expert Opinion (**Exhibit RF-D10**), §§ 81-89, Koskenniemi’s Expert Opinion (**Exhibit RF-03.1.C-1.3.4**), §§ 26-30, Professor Nolte’s 2006 Expert Opinion (**Exhibit RF-03.1.C-1.3.7**), §§ 50, 62-65, and Professor Nolte’s 2016 Expert Opinion (**Exhibit RF-D12**), §§ 61, 72 and 74.

¹⁹⁵ Fremantle’s Expert Opinion (**Exhibit RF-03.1.C-1.3.3**), § 34.

to the domestic courts. According to him, this means that the signatories are not obliged to apply the provisions on dispute resolution provisionally:

“Most national and subnational laws provide that disputes under those laws go to the local courts, not to international arbitration, unless there is a special provision to that end. Consequently, I imagine that, generally speaking, provisional application will not bind the signatories to Articles 30 and 31 [in the later final text: Articles 26 and 27 ECT].” (emphasis added by counsel)¹⁹⁶

147. Mr Fremantle’s view was shared by Mr Bamberger, chairman of the legal advisory committee to the Energy Charter Conference. Mr Bamberger emphasized that provisional application “*may be especially problematical as concerns the acceptance of legally binding resolution in an international forum of disputes over domestic matters.*”¹⁹⁷
148. HVY believe that the constitutional, institutional and civil-law objections that the United States of America, Canada, Norway and Italy, among others, raised at the time were not at play in the Russian Federation at all. They believe that the far-reaching arbitration mechanism of Article 26 ECT, which could not be applied provisionally in countries such as Germany, France and the Netherlands, would be perfectly acceptable in the Russian Federation. In this light, HVY make it appear as if the Russian legal system is the most arbitration-friendly legal system of them all.¹⁹⁸
149. The reality is that the Russian Federation – like other Eastern European States – has a long tradition of exercising great restraint with respect to international arbitration in national laws and regulations. The same applies to the willingness to resolve international investment disputes through arbitration. See, for example, the Agreement on the Promotion and Reciprocal Protection of Investments between the Netherlands and the USSR. The Dutch Minister explained to the Dutch House of Representatives in a Memorandum dated 7 February 1990 that arbitration was met with great resistance. As a result, the investment treaty ultimately included an arbitration clause with a very limited scope. Most investment disputes (including disputes concerning expropriation) could not be arbitrated:

¹⁹⁶ Fremantle’s Expert Opinion (**Exhibit RF-03.1.C-1.3.3**), Annex A.

¹⁹⁷ See R-866, 16.

¹⁹⁸ See SoA, Chapter 6 (§§ 540 et seq.). See also SoD, Part I, §§ 69-72 and SoD, Part II §§ 229 et seq., with reference to the Tribunal’s ruling.

The Soviet delegation initially objected in principle to the inclusion of an arrangement as regards an international dispute resolution procedure for disputes between an investor and the host country. Ultimately, the Soviet delegation agreed to a list of disputes to which such an arrangement would apply. These concern the free transfer (Article 4) and the amount and/or the compensation procedure in the event of expropriation or nationalisation (Article 6). Not arbitrable are the decisions to expropriate or nationalise, as the Soviet delegation considered this to be a violation of its national sovereignty. Disputes regarding the fair and just treatment of investments cannot be arbitrated either. (...)¹⁹⁹ (emphasis added)

150. The investment treaty between the Russian Federation and the Netherlands that entered into force on 20 July 1991 is one of the first investment treaties of the, at that time, USSR. In the early 1990s, the Russian Federation applied a robust policy whereby it concluded a number of very similar investment treaties (see also §§ 441 et seq. below).²⁰⁰ All these treaties had in common that they only offered very limited room for the arbitration of disputes.²⁰¹
151. Arbitration of a dispute such as the present dispute was not only inconsistent with the (then-applicable) laws of Norway, Canada, Germany and France, among others, but was also, at all relevant times, incompatible with Russian law.²⁰² This means that the Russian Federation was not obliged to provisionally apply Article 26 ECT.
152. At an early stage in the negotiations, representatives of the Russian Federation have indicated to other States that investment disputes are solely resolved by the domestic courts (see § 330 below). Afterwards, it was also explicitly stipulated that Article 26 ECT was inconsistent with Russian law and was not applied provisionally. One of these occasions was the public parliamentary hearing of the legislative proposal to ratify the ECT. In 1997, for instance, Professor Bystrov stated to the Duma that the Russian Law on the Subsoil does not provide for “*the resolution of disputes, for example, in the Arbitration Institute of*

¹⁹⁹ Agreement with the USSR on the Promotion and Reciprocal Protection of Investments, *Parliamentary Papers II*, 1989/90, 21462 (Kingdom Act 1383), 1 (Memorandum accompanying the letter of the Minister dated 7 February 1990). (emphasis added).

²⁰⁰ In that same period, the USSR also concluded several other treaties with other States, including the United Kingdom, Spain, Switzerland, Korea and Belgium, that would also enter into force in 1991.

²⁰¹ See Writ, § 228, and the investment treaties cited and submitted therein as **Exhibits RF 51-60**. See also Writ, footnote 242, (**Exhibit RF-48**).

²⁰² SoR, §§ 64-65, 149 and 151. The substance of the relevant Russian legislation has not changed between 1994 and today. Contrary to what HVY assert (SoA, § 312), arbitration of their claims was inconsistent with Russian law, including Russian constitutional law, at all relevant times.

the Chamber of Commerce in Stockholm”.²⁰³ In 2001, the vice-chairman of Transneft stated to the Duma that the Treaty must first be ratified before disputes could be resolved through arbitration. The final conclusions of the Duma in 2001 show that it was generally assumed that only the Treaty’s ratification and entry into force would result in additional options “*to resolve disputes on an international level on issues of (...) foreign investments (...)*”. For an extensive description of the parliamentary hearing, see §§ 326-335 below.²⁰⁴

153. In the Arbitration the Russian Federation has advanced three independent arguments on the basis of which arbitration of this dispute is inconsistent with Russian law. These can be (briefly) summarized as follows:

- (a) The District Court correctly ruled that it is contrary to the principle of the separation of powers laid down in the Russian Constitution and laws for the Russian government were to unilaterally accept the provisional application of Article 26 ECT on behalf of the Russian Federation. Indeed, treaties containing arbitration provisions, such as Article 26 ECT, need to be ratified (see subsection (b) below).²⁰⁵
- (b) HVY base their claims on the assertion that Russian tax assessments and collection measures constitute an unlawful expropriation. The District Court correctly ruled that it is inconsistent with Russian laws to submit such non-arbitrable tax or expropriation disputes to arbitration (see subsection (c) below).²⁰⁶
- (c) HVY have instituted legal proceedings for a decrease in value or loss of their shares as a result of damage caused to the company Yukos Oil. It is inconsistent with Russian laws to file such a “derivative” action (see subsection (d) below).²⁰⁷

²⁰³ See §§ 326-335 below.

²⁰⁴ The Russian Federation hereby contests HVY’s assertions in SoA, § 545.

²⁰⁵ See Writ, §§ 186-204, SoR, §§ 129-149.

²⁰⁶ This follows from Russian laws such as the Tax Code, the Law governing Attachments and Executions, the Bankruptcy Act, the Codes of Civil Procedure and the federal Laws on Arbitral Tribunals. Writ, §§ 208-240 and SoR, §§ 152-182.

²⁰⁷ Writ, §§ 241-244 and SoR, §§ 183-185.

154. The District Court considered the Russian Federation’s first and second argument well-founded; it did not discuss the third argument. The three arguments are discussed once more below.

(b) *It is inconsistent with the Russian Constitution to apply Article 26 ECT provisionally without the consent of Parliament*

The Russian Federation refers to:		
<u>Arbitrations:</u>		
-	-	-
<u>Setting aside proceedings:</u>		
Writ	Chapter IV.C.c	§§ 191-204
SoD	Part I, Chapter 3.2.2	§§ 61-67
	Part II, Chapter 2.1.3	§§ 215-218
SoR	Chapter III.C.d	§§ 57, 141-142
SoRej	Chapter 2.2.3	§§ 92-104
RF Pleading Notes	Chapter III.3	§§ 20-22
HVY Pleading Notes	Chapter 1.2.1	§§ 25-37
SoA	Part I, Chapter 5.5	§§ 491-503

Primary exhibits:	
<u>Arbitrations:</u>	
	Nussberger Expert Opinion
<u>Setting aside proceedings:</u>	
RF-44-RF-48	Russian regulations from which the requirement of ratification by Parliament emerges Avtonomov Expert Opinion

Essence of the reasoning

In the Arbitration the Russian Federation has advanced three independent arguments on the basis of which arbitration of the present dispute is inconsistent with Russian law. The first argument is that the provisional application of Article 26 ECT is inconsistent with the separation of powers principle.

- The classic principle of the separation of powers is explicitly and prominently anchored in the Russian Constitution of 1993 (section (b)(i)(i)).
- The powers of the executive are restricted by the Constitution and federal legislation (section (b)(i)(iii)).
- The powers of the government with regard to the conclusion of treaties are limited (section (b)(i)(iv)).
- The government cannot unilaterally deviate from the Constitution or from federal laws by assigning adjudicatory powers to arbitrators (section (b)(ii)).
- The provisional application of Article 26 ECT (without parliamentary approval)

is – as is generally accepted in case law and legal literature – contrary to the constitutional separation of the executive, legislative and judiciary powers (section (b)(iii)).

(b)(i) The separation of powers under Russian constitutional law

(b)(i)(i) The new Constitution of 1993 is based on the separation of powers

155. In the Arbitration the Russian Federation has advanced three independent arguments on the basis of which arbitration of the present dispute is inconsistent with Russian law. The first argument is that the provisional application of Article 26 ECT is inconsistent with the separation of powers principle.
156. The Constitution of the Soviet Union of 1936, as last amended in 1977, provided for the concentration of state power. Article 93 of the Constitution of 1977 determined that the Soviets had to manage all economic, social and cultural development sectors. Soviets were authorized to make the required decisions in this context and were also responsible for the execution and implementation thereof. Article 108 of the 1977 Constitution provides that the highest state power was held by the Supreme Soviet of the Union (Parliament). The Constitution of 1977 also assigned an important role to the Communist Party, which effectively dominated the Supreme Soviet.²⁰⁸
157. After the dissolution of the Soviet Union there was a broad consensus that the concentration of state power that had existed up to that time was undesirable.²⁰⁹ The generally accepted opinion was that a new constitutional order had to provide for a separation of powers. The parties that drew up the new Russian Constitution of 1993 were to large degree influenced by the works of the French philosopher Charles de Montesquieu. Afterwards they emphasized several times that all draft texts of the new Russian

²⁰⁸ See A. Nussberger's expert opinion dated 17 January 2007, titled "Opinion Concerning the Provisional Application of the Energy Charter Treaty by the Russian Federation" (**Nussberger's Expert Opinion, Exhibit RF-03.1.C-1.3.8**), p. 16. In this context, see the hearing transcript dated 20 November 2008, p. 62, and the sources referred to there. Compare also Article 6 of the Constitution, which provided that the Communist party played a leading social role.

²⁰⁹ See Nussberger's Expert Opinion (**Exhibit RF-03.1.C-1.3.8**), pp. 16 et seq. See Professor Avtonomov's expert opinion dated 6 November 2017, titled "The Position of Provisionally Applicable, Unratified Treaties Under the 1993 Constitution of the Russian Federation and the Hierarchy of Legal Norms" (**Professor Avtonomov's Expert Opinion, Exhibit RF-D4**), §§ 35-40.

Constitution provide for a further elaboration of the notion of the separation of powers that had been fleshed out by Montesquieu.²¹⁰

158. The principle of the separation of powers is explicitly and prominently anchored in the Constitution of 1993.²¹¹ In this context, the District Court correctly referred to the provision in Article 10 of the Russian Constitution.²¹² This provision makes it clear that state power in the Russian Federation is exercised by three separate and independent powers, i.e. the legislative, executive, and judicial powers:

“State power in the Russian Federation shall be exercised on the basis of its division into legislative, executive and judicial. The legislative, executive and judicial authorities shall be independent.”²¹³

159. The principle of the separation of powers is further elaborated in the other provisions of the Russian Constitution. The authority of each of the three powers is further described in the Russian Constitution, with each of the three units having its own respective chapter.²¹⁴

(b)(i)(ii) *The primacy of the Russian Constitution and federal legislation*

160. In the hierarchy of legal standards, in the Russian legal system the Russian Constitution has a leading role. The Russian Constitution is ranked higher than treaties, federal laws and secondary legislation. If treaties or acts are in breach of the Constitution, they will be disregarded as being unconstitutional or will be declared inapplicable. In the Russian Federation the Constitutional Court must assess whether treaties, acts, decrees and secondary legislation are constitutional.
161. Federal laws have a very prominent place in the Russian regime. The Russian Constitution determines that the people are sovereign (Article 3 Constitution). The Russian Parliament represents the sovereign people. In the Constitution, the Parliament is defined as the

²¹⁰ See in this regard Nussberger’s Expert Opinion (**Exhibit RF-03.1.C-1.3.8**), pp. 15 et seq., Professor Avtonomov’s 2017 Expert Opinion (**Exhibit RF-D4**), §§ 31, 34.

²¹¹ In this context, see SoR, §§ 136-137. See also the commentaries cited in SoR, § 141 and Nussberger’s Expert Opinion (**Exhibit RF-03.1.C-1.3.8**), pp. 16-17.

²¹² Judgment, ground 5.75. This, by itself, is not contested; see also SoA, § 492.

²¹³ English translation.

²¹⁴ The Russian Constitution devotes a separate chapter to each of the powers. See chapters 4 and 6 (Executive Power), 5 (Legislative Power), and 7 (Judicial Power) of the Constitution. That the principle of the separation of powers is explained in detail in the Constitution is not in dispute. See also SoA, § 498.

“representative and legislative power of the Russian Federation” (Article 94 Constitution). The primacy of federal legislation is therefore inextricably linked to the fact that it is concluded with the permission of the Parliament that was chosen democratically.²¹⁵ In this context, the restriction applies that federal laws may not and cannot be in breach of the Russian Constitution.²¹⁶

(b)(i)(iii) *The powers of the executive power are restricted by federal legislation.*

162. Article 15(2) of the Russian Constitution stipulates, in general terms, that “[t]he bodies of state authority (...) shall be obliged to observe the Constitution of the Russian Federation and laws.”²¹⁷

163. Article 110 of the Russian Constitution provides that the government exercises the executive power.²¹⁸ Article 114 of the Constitution lists some specific powers of government, including the power to implement the foreign policy. However, entirely in line with the principle of the separation of powers, the powers of government are limited by federal laws. The government can independently issue decrees and take decisions. However, the government cannot deviate from federal laws adopted with the assistance of the Parliament when exercising its powers. This follows, inter alia, from Article 115 of the Constitution²¹⁹:

“1. On the basis and for the sake of implementation of the Constitution of the Russian Federation, federal laws, normative decrees of the President of the

²¹⁵ See Professor Avtonomov’s Expert Opinion (**Exhibit RF-D4**), §§ 46-48 and the sources of law cited there.

²¹⁶ See Article 15(1) and 76(3) of the Russian Constitution. See Professor Avtonomov's Expert Opinion, (**Exhibit RF-D4**), §§ 39-41. For example, Professor Avtonomov quotes a former judge of the Constitutional Court who describes the matter as follows, original English text: “...this body [the Federal Assembly] is designed to express the will of the multi-national people of the Russian Federation that is the holder of sovereignty and the sole source of power in Russia.”

²¹⁷ See (R-163). English translation: “The bodies of state authority (...) shall be obliged to observe the Constitution of the Russian Federation and laws.”

²¹⁸ Article 110(1) Russian Constitution (R-163), English translation of the original Russian text: “Executive power in Russia shall be exercised by the Government of the Russian Federation.”

²¹⁹ See for example also Article 2 of the 1997 Constitutional Law On the Government of the Russian Federation (17 December 1997), (R-427), English translation of the original Russian text: “Article 2. The Legal Framework of Activities of the Government of the Russian Federation The Government of the Russian Federation shall carry on its activities on the basis of the Constitution of the Russian Federation, the federal constitutional laws, the federal laws and the norm-setting decrees of the President of the Russian Federation.”

Russian Federation the Government of the Russian Federation shall issue decisions and orders and ensure their implementation.²²⁰

164. The Russian Constitution also assigns executive powers to the Russian President. For example, Article 86 of the Russian Constitution provides that the power to execute the foreign policy mainly lies with the Russian President. In addition, the Russian President has the power to issue decrees. Entirely in line with the principle of the separation of powers, the powers of the Russian President are limited by federal laws. For example, Article 90 of the Constitution prescribes that decrees of the President cannot be in breach of federal laws (see also § 401 below).

(b)(i)(iv) *The District Court rightly ruled that the separation of powers implies that the powers of the government with regard to entering into obligations (ground 5.84).*

165. The primacy of federal legislation and the principle of the separation of powers also extends to the manner in which treaty obligations are entered into.²²¹ All treaties deviating from federal statutes must be ratified by means of a federal law. In this way, the consent of the “sovereign” parliament is expressed through the treaty. Without ratification, a treaty cannot prevail over federal laws (see also §§ 419 et seq. below).²²²

166. Article 106 of the Russian Constitution of 1993 provides that federal laws on “*the approval and denunciation of international treaties and agreements of the Russian Federation*” must be passed by the Parliament of the Russian Federation.²²³ This basic premise is further developed in federal laws.

167. In 1978, the former Soviet Union adopted the law on the procedure for the conclusion, implementation and denunciation of international treaties. Article 12 of this law provides

²²⁰ Article 115(1) of the Russian Constitution (R-163). English translation of the original Russian text.

²²¹ See § 425 for an example whereby the government wrongly failed to present a treaty to Parliament. This was deemed to be in breach of the provisions of Article 115 of the Constitution.

²²² **Exhibit RF-264**, Yu. A. Tikhomirov, "The Implementation of International Legal Acts in the Russian Legal System", *Russian Law Journal*. 1999. No. 3-4. English translation of the original Russian text ("*The law serves as the form of 'sovereign acknowledgment' of the incorporation of an international act into the legal system.*").

²²³ See Judgment, grounds 5.78-5.83, with reference to SoR, § 141. This has not been contested; see also SoA § 444.

that “(...) *treaties providing for rules different from those contained in the USSR legislative acts are subject to ratification (...)*”²²⁴

168. A similar arrangement is included in the Federal Law on International Treaties (“FLIT”), which entered into force shortly after the signing of the ECT. Article 6(2) FLIT provides that State organs may only render a decision to grant consent to be bound by a treaty if they thereto act in accordance with their constitutional competences.²²⁵ Article 15 FLIT provides that Parliamentary approval is required for “*international treaties whose implementation requires the amendment of existing legislation or enactment of new federal laws, or that set out rules different from those provided by law*”.²²⁶
169. Consequently, the Russian government is only authorized to enter into treaty obligations on behalf of the Russian Federation within the limits of the Constitution and existing (federal) laws.²²⁷ When a treaty is different from existing legislation or requires the enactment of new legislation, the treaty requires the approval of the Russian Parliament. On this point, Russian law is largely similar to the laws of other European States, such as the Netherlands, France and Germany (see §§ 41-54 above).²²⁸

²²⁴ Article 12 of the law of 1978 “*on the procedure for the conclusion, implementation and denunciation of international treaties of the USSR*”. English translation of the original Russian text: “*International treaties of the USSR on friendship, cooperation and mutual assistance, treaties on reciprocal renunciation of force or threats of force, peace treaties, treaties on territorial delimitation with other States, treaties providing for rules different from those contained in the USSR legislative acts, are subject to ratification. (...)*” This has not been contested; see also SoA, footnote 295. See Professor Avtonomov’s Expert Opinion (**Exhibit RF-D4**), § 58.

²²⁵ State authorities may only take a “*decision on consent (...) to be bound by international treaties (...) in accordance with the competence established by the Constitution of the Russian Federation, this federal law, and other laws of the Russian Federation.*”

²²⁶ English translation of Article 15 FLIT. In this context, see also SoR, §§ 143-144.

²²⁷ In this context, see also Article 21 of the Federal Constitutional Law No. 2-FKZ of 17 December 1997 (R-427), English translation of the original Russian text: “*Article 21. Powers of the Government of the Russian Federation in the Sphere of Foreign Policy and International Relations. The Government of the Russian Federation shall (...) while acting within its respective powers enter into international treaties of the Russian Federation, ensure the compliance with the Russian Federation’s commitments under international treaties as well as supervise the compliance by other members of the said treaties with their commitments (...)*”. See § 425 for an example whereby the government had exceeded its powers and the treaty consequently had no priority over federal laws within the Russian legal system.

²²⁸ Apparently, HVY believe that the Russian legal system is completely different from the legal system of the Netherlands (see SoA, §§ 420 and 448). This assertion is incorrect.

170. In light of the foregoing, the District Court rightly ruled that the principle of the separation of powers in the Russian Federation means that the powers of the government to conclude treaties are limited:

“5.84. The cited experts and commentators support the standpoint of the Russian Federation that the Federal Parliament plays a vital role in the constitutional system in effectuating international treaties that deviate from or supplement Russian legislation. The court follows this standpoint. The approval of the binding force of international treaties— especially if a treaty deviates from or adds new provisions to national legislation – cannot be viewed as anything other than the creation of new legislation. Following from this and based on the principle of the separation of powers, the authority to create new legislation is exclusively accorded to the legislature.”

(b)(ii) The District Court correctly ruled that the provisional application of Article 26 ECT is inconsistent with the principle of the separation of powers laid down in the Russian constitution and laws (grounds 5.74-5.94)

171. When the ECT was signed in December 1994, the Russian Federation had no specific constitutional or statutory arrangement on the provisional application of treaties.²²⁹ This means that in the Russian Federation – as was the case in the Netherlands for a long time²³⁰ – the government’s authority to unilaterally consent to the provisional application of a treaty on behalf of the Russian Federation had to be established on the basis of constitutional and statutory provisions.²³¹
172. Similarly, in the Netherlands, the government cannot unilaterally amend the statutory provisions on arbitration. For example, the Dutch government cannot issue a general administrative order that deviates from the provisions on arbitration in the Dutch Code of Civil Procedure. Moreover, the powers of public bodies to agree to arbitration are limited in the Netherlands. For example, a Municipality cannot agree with a construction company that the question whether a zoning plan should be amended will be answered exclusively by arbitrators.²³² The same applies in the Russian Federation. As has been explained in

²²⁹ Article 23(1) of the Russian FLIT first entered into force after the signing of the ECT.

²³⁰ See Professor Heringa’s Expert Opinion (**Exhibit RF-D1**), parts II-IV.

²³¹ See also the case law cited in § 421 below.

²³² See in a general sense H.J. Snijders, Groene Serie (2013), Article 1020, annotation 5: “*Not every matter can be arbitrated (...) the powers of legal persons under public law to enter into arbitration agreements [are] limited (...)*” K.J. de Graaf, Schikken in het bestuursrecht (doctoral thesis) Groningen: Bju 2004, pp. 16-28. “*The Netherlands are a democratic state under the rule of law. Even though this is open for discussion, this statement essentially means that the actions of the government vis-à-vis the citizen are bound to the law. The intervention of the government in the freedom of the citizens must be predictable*”

detail below, the powers of the Russian government are determined but also limited by the existing constitutional and legal framework.²³³ Consequently, the Russian government can only introduce or apply a binding general arbitration scheme if there is sufficient constitutional or legal basis to do so. Furthermore, the government is bound to existing federal legislation and cannot unilaterally reverse it or otherwise brush it aside. The government cannot independently strip the judiciary of powers and assign these powers to third parties.

173. In theory, it is conceivable that the Russian Parliament could delegate the power to consent to (the provisional application of) an investment treaty with a general arbitration scheme on behalf of the Russian Federation to the government through federal law. In Professor Asoskov's expert opinion it is explained that there are strict rules in the Russian Federation for the delegation of legislative powers.²³⁴ The delegation of power under public law by the Parliament is only possible by means of federal law. Furthermore, it is required that the powers that are delegated are described in a clear and precise manner.²³⁵ The power to provisionally apply or approve an investment treaty with an arbitration scheme was never delegated.²³⁶ As a result thereof, there is no constitutional or legal basis under which the government could unilaterally implement a binding arbitration rules that deviate from the

and not random. This requires that the government's power is divided and is bound to fixed and clear general rules. The democratic organisation of the state contributes to the legitimacy of these rules, whereas independent case law gives citizens the possibility to have government action tested against the law. (...) Finally a special implication of the principle of legality that an agreement cannot infringe the statutory division of with powers under public law. Administrative law has a specific arrangement for delegation powers under public law (section 10.1.2 General Administrative Law Act). Transferring these powers by means of an agreement is therefore impossible, so that an arbitrator or a third party charged with giving a binding opinion does not have the power to have its judgment or binding opinion apply as a decision. A decision that has already been made cannot be set aside by a third party other than the administrative court. The fact that an administrative authority has undertaken to exercise a power in a manner to be determined by a third party is at odds with the principle of legality. In that case, it is not the administrative authority itself but a third party that renders a decision about the manner in which power is exercised. (...)". (emphasis added)

²³³ See § 162 above and §§ 419 et seq. below.

²³⁴ See Professor Anton V. Asoskov's expert opinion dated 10 November 2017 (**Professor Asoskov's 2017 Expert Opinion, Exhibit RF-D5**), §§ 119-122.

²³⁵ For example, in federal law No. 76 of 26 December 1994 Russian Parliament assigned the power to the Russian Government to ratify treaties by means of which the Russian States provides or attracts financing. In the specific law, the conditions under which the government may exercise these powers are precisely described. In essence, the government can only exercise these powers within the limits of the government loan programme that is annually approved by Parliament.

²³⁶ HVY do not argue either that the power to provisionally apply or ratify investment treaties has been explicitly delegated to the government by means of a federal law.

existing procedural legislation. The same applies for the lack of power of the Russian government to agree to “ad hoc” arbitration about a tax or expropriation dispute.

174. Moreover, the government’s power to consent to the provisional application of a treaty is explicitly limited in Russian legislation. Article 23(2) FLIT provides that a decision to apply a treaty that differs from federal laws provisionally for longer than six months must be passed in the form of a federal law.²³⁷ This means that such decisions must be submitted to the Duma for approval.²³⁸ In the assessment of this case, the District Court rightly attributed significance to this internal²³⁹ rule of Russian law.²⁴⁰ This statutory provision

²³⁷ Seen in isolation, it is correct that the FLIT was not in force when the Russian Federation signed the ECT on 17 December 1994 and that the whole law as such has no retroactive effect (Writ, § 197). What is most confusing is that HVY constantly adopt different and conflicting positions on the applicability of the FLIT (see §§ 392 et seq. below). As concerns the applicability of – very specifically – Article 23(2) of the FLIT and the assertions in SoA, §§ 421, 424, 504-516, reference is made for the sake of brevity to Writ, §§ 197, 199, Nussberger’s Expert Opinion (**Exhibit RF-03.1.C-1.3.8**), pp. 35-36, Order of the President No. 370-RP (August 7, 1995) (C-141), translation of the original text: “*1. The Ministry of Foreign Affairs of Russia and other federal agencies of executive power jointly with the Ministry of Foreign Affairs of Russia or by agreement with it shall submit respectively to the President of the Russian Federation or to the Government of the Russian Federation proposals for submitting to the State Duma according to Article 23(2) of the Federal Law on International Treaties of the Russian Federation within a 6-month period from the date of entry of international treaties into force by virtue of this Law, the decision concerning consent to the obligatoriness for the Russian Federation of which is subject to adoption in the form of a federal law and the provisional application of which by the Russian Federation has commenced before the entry into force of the said Law.*”

²³⁸ Translation of the original text: “(...) *If an international treaty (...) provides for the provisional application of the treaty or a part thereof (...), then this treaty shall be submitted to the State Duma within six months from the start of its provisional application. The term of provisional application may be prolonged by way of a decision taken in the form of a federal law (...).*” Article 23(2) FLIT (**Exhibit RF-47**), English translation of the original Russian text: “(...) *If an international treaty – the decision on the consent to the binding character of which for the Russian Federation is, under this Federal Law, to be taken in the form of a Federal Law – provides for the provisional application of the treaty or a part thereof, or if an agreement to that effect was reached among the parties in some other manner, then this treaty shall be submitted to the State Duma within six months from the start of its provisional application. The term of provisional application may be prolonged by way of a decision taken in the form of a federal law according to the procedure set out in Art. 17 of this Federal Law for the ratification of international treaties.*” In this context, see also the memorandum dated 8 July 1997, drawn up specifically in view of the ECT (C-925). Original English text: “(...) *[F]or six months from the date of the beginning of the provisional application, the treaty should be submitted to the State Duma. Thereby, as follows from Art. 23(2) of the Law, a proposal can be made to ratify the treaty or to prolong its provisional application.*”

²³⁹ Like the separation of powers principle anchored in the Russian Constitution, Article 23(2) FLIT is an internal rule of Russian national law. It is correct that, generally speaking, a violation of the rule included in Article 23(2) FLIT does not automatically result in the immediate termination of the provisional application under international law (SoA, § 520, see also SoA, §§ 530 et seq.). Generally, the question whether internal national requirements are met is irrelevant to the question whether the Russian Federation is obliged to provisionally apply the treaty in question under international law. In this specific case, Article 45 ECT provides that signatories will apply the Treaty provisionally to the extent that it is compatible with national laws and regulations.

²⁴⁰ See Judgment, ground 5.94: “5.94. *The provisions of Article 23 paragraph 2 FLIT, which is a supplement to the general rule of Article 23 paragraph 1 FLIT, do not affect this opinion. Based on this second*

confirms that it is contrary to the principle of the separation of powers if the Russian government were to consent, on behalf of the Russian Federation, to the provisional application of the entire Treaty without any qualification.

175. The District Court thus rightly ruled that the provisional application of a treaty that differs from federal laws requires parliamentary consent.²⁴¹ Any other opinion would in fact allow the government to deviate from existing legislation and would therefore disregard the entire principle of the separation of powers.

176. The District Court correctly concluded²⁴² that treaties such as the ECT, which differ from Russian legislation, require ratification before they can be applied. Such treaties cannot be applied on the basis of a mere signature. The provisional application of Article 26 ECT is therefore inconsistent with the Russian Constitution and the principle of the separation of powers enshrined therein:

“5.93. The constitutional limitations discussed above require that treaties that deviate from or supplement national Russian laws cannot be applied based only on their signature, but require prior ratification. In accordance with this, these limitations also apply if treaties, like the ECT, are applied provisionally. (...) The Constitution and the principle of the separation of powers enshrined therein preclude a representative of the executive from being able to bind the Russian Federation to Article 26 ECT. This means, as is also argued by the experts Avakiyan (Opinion of 21 February 2006, pages 8 and 9) and Baglay (Opinion, page 5), as well as A. Martynov in an opinion of 14 December 2006, who at the time participated in the negotiations on the ECT on behalf of the Ministry of Foreign Economic Relations of the Russian Federation, that provisional application of Article 26 ECT is contrary to the constitutional separation of the executive, legislative and judiciary powers.” (emphasis added)

paragraph, a treaty that must be ratified by federal law and which provides for the provisional application must be submitted to the Federal Parliament within six months. Although it should be ruled that provisional application of the arbitration clause was incompatible with the Constitution and the ensuing principle of the separation of powers from the outset – given the assessment framework of Article 45 paragraph 1 ECT and the significance attached therein to the Constitution – it is agreed that the provisional application was no longer in accordance with the Constitution after the six-month term. (...) [I]n the absence of approval of the legislature, the Limitation Clause precluded a longer provisional application of Article 26 ECT than the six months. (...)”

²⁴¹ See Judgment, grounds 5.74-5.95, in particular ground 5.93.

²⁴² See also Writ, §§ 191-207, and SoR, §§ 129-149 and the sources of law cited therein.

(b)(iii) *The District Court's ruling is in line with numerous of sources of Russian law*

177. The District Court's ruling that the provisional application of Article 26 ECT is inconsistent with the separation of powers principle laid down in the Russian constitution and laws contains 21 grounds. These include many references to Russian legislation, decisions by higher Russian courts, Russian legal literature and expert opinions. The District Court's ruling stands in stark contrast to the Tribunal's opinion, which is rather scanty in this respect, in which the limited governmental powers to provisionally apply treaties on behalf of the Russian Federation is not really discussed. In the words of the District Court, the Tribunal "*did not formulate a specific opinion*" on the separation of powers principle.²⁴³
178. The District Court's judgment is in line with what officials of the Russian Federation expressed to other States both before and after the 1993 Constitution entered into force. The important role of the Russian Parliament that ultimately had to ratify the Treaty was emphasised several times during the negotiations. When representatives of the ECT Secretariat and the EC visited Moscow in June 1993, they were told that the Russian government was getting too far ahead. On this occasion, members of the Parliament have indicated that the powers of the government were limited and that it was important to involve the Parliament more actively in the negotiations.²⁴⁴ To ensure a timely involvement of Parliament, Mr Kalistratov, a prominent member of the Russian Parliament, attended the negotiations.²⁴⁵ He was introduced by Minister Shatalov as a negotiator and an important

²⁴³ Judgment, ground 5.74.

²⁴⁴ Mr Clive Jones, the Secretary General of the ECT Secretariat described it as follows in his report (European Energy Charter Treaty Conference Secretariat, Note for the file, subject: visit to Moscow 15-17 June 1993, 18 June 1993) (**Exhibit RF-265**): "*Mr Rutten said that we fully recognised the importance of the Supreme Soviet's role and the ratification process. (...) Mr Kalistratov said that the Supreme Soviet had so far been excluded from the work on the Treaty. They should receive all documents and participate in the Conference discussions. (...) Mr Zorkaltsev said that the Russian Government was getting 'too far ahead' in the negotiations. They did not have full authority to negotiate.*"

²⁴⁵ Kalistratov had already explained in bilateral talks with representatives of the European Union that the government underestimated the importance of Parliament. He already announced back then that he would personally attend the next plenary session. Report of unofficial negotiations between the Russian Federation and the European Commission (**Exhibit RF-266**), § 3: "*Mr KALISTRATOV put a new accent on the government's declarations as he states that the Russian government was gravely underestimating the Parliament's importance. (...) [H]e stressed the paramount importance of regions, territories and autonomous republics in Russia, as these detain the largest deposits of energy. Within the present constitutional struggle, they might get more power and independence from Moscow. He announced that he would personally come to the next charter plenary. The Community Chairman welcomed the Supreme Soviet's involvement and proposed to continue oral contacts with Mr KALISTRATOV.*"

energy expert at the plenary session of 28 June 1993.²⁴⁶ Later, the Russian government confirmed several times that it was necessary to inform the Russian Parliament in a timely manner and involve it in the formation of the ECT. To that end, seminars were organised and other measures were taken in cooperation with the ECT Secretariat.²⁴⁷

179. The opinion of the District Court is entirely in line with Russian case law and literature. After all, it is generally assumed that the principle of the separation of powers that is laid down in the Constitution and the law does not allow an unlimited application of non-ratified treaties. This is consistent with the hierarchy of legal standards as follows from Article 15(2) of the Russian Constitution. Moreover, only treaties that have been ratified prevail over federal laws within the Russian legal system (see Article 15(4) of the Russian Constitution and §§ 419-434 below).
180. For the sake of brevity, the Russian Federation refers to the following expert opinions, in which dozens of other sources of law are cited:

- (a) Nussberger Expert Opinion. Professor Angelika Nussberger (current vice president of the European Court of Human Rights) was Professor and director at the Institute for Eastern European Law of the University of Cologne. She has written many publications that concern Russian constitutional law. In her expert report dated 17 January 2007, she addresses the historical backgrounds of the Russian Constitution in detail.²⁴⁸ She explains the principle of the separation of powers. Prof. Nussberger clarifies that only treaties that have been ratified prevail over federal laws within the Russian legal system (see in particular §§ 419-434 below).

²⁴⁶ Plenary, 28 June 1993, Audio file P28061993EN1_19, minute 28.

²⁴⁷ Clive Jones Report (Secretary-General of the ECT Secretariat), European Energy Charter Treaty Conference Secretariat, Note for the file, subject: visit to Moscow 15-17 June 1993, dated 18 June 1993. Report of discussions with various Russian representatives (**Exhibit RF-265**). See also Message No. 174, Charter Seminar For Parliamentarians September 1993 dated 1 July 1993 (**Exhibit RF-267**). See, for example, the message of A. Shatalov (Deputy Minister of the Ministry of Fuel and Energy of the Russian Federation) to C.S. Maniatopoulos of 10 October 1994 (**Exhibit RF-268**): "*[I]t appears reasonable to my mind to start in February-March 1995 actions aimed at reaching the Russian Parliamentarians as well as policy-making people in the Presidential Staff and the Government a view to getting them practically acquainted with the rights and obligations of the Member Countries of the Charter and their anticipated impact on the economic developments in Russia.*"

²⁴⁸ See Nussberger's Expert Opinion (**Exhibit RF-03.1.C-1.3.8**) on the provisional application of the ECT by the Russian Federation.

- (b) Baglay's Expert Opinion. M.V. Baglay was a judge of the Constitutional Court of the Russian Federation.²⁴⁹ In his expert opinion dated 26 February 2006, Baglay explains that the ECT is a legislative treaty that deviates from federal laws and requires approval from Parliament. Baglay makes clear that the government is not allowed to bring about that the Russian Federation must apply such international treaties before having been ratified.
- (c) Avakiyan's Expert Opinions. Professor S.A. Avakiyan, head of the Constitutional and Administrative Law Department of Moscow State University's faculty of law.²⁵⁰ Avakiyan explains in his expert opinions, submitted in the Arbitrations, that the application of a legislative treaty prior to its ratification is contrary to the Russian Constitution.
- (d) Professor Avtonomov's Expert Opinion Professor Avtonomov is a renowned Professor of constitutional law who has written many international publications. He serves as a member of the UN-Committee on the Elimination of Racial Discrimination and as an advisor to the Russian Parliament. In his expert opinion, he discusses the hierarchy of Russian legislation and the principle of the separation of powers in detail.²⁵¹ He explains that unratified treaties applied provisionally do not prevail over federal legislation (see in particular §§ 419-434 below).

181. After the District Court in The Hague rendered its reasoned judgment, HVY adopted entirely new positions. In essence, they argue that the 1993 Constitution allegedly introduced a "*super-presidential democracy*". They ultimately derive the conclusion that the President is authorised to provisionally bind the Russian Federation to treaties independently and without any limitation. One does not find such a statement in the very extensive procedural documents and expert opinions which HVY have submitted in the Arbitrations. As has been set out in §§ 257-267 and 268-277, HVY are not entitled to

²⁴⁹ Baglay's expert opinion dated 26 February 2006, titled "Opinion on Provisional Application of International Treaties According to the Constitution of the Russian Federation" (**Baglay's Expert Opinion**), submitted in the Arbitrations, Exhibit RF-03.1.C-1.1.1.

²⁵⁰ Avakiyan's expert opinions dated 21 February 2006, titled "Expert Opinion on the Constitutional Legal Aspects of the Conclusion and Application of International Treaties of the Russian Federation" (**Avakiyan's First Expert Opinion**), submitted in the Arbitrations, Exhibit RF-03.1.C-1.1.4, and dated 29 June 2006, titled "Expert Comments" (**Avakiyan's Second Expert Opinion**), submitted in the Arbitrations, Exhibit RF-03.1.C-1.3.1.

²⁵¹ Professor Avtonomov's Expert Opinion (Exhibit RF-D4).

present these new and partly deviant assertions about President Yeltsin and the 1993 Constitution only at this stage. Moreover, these new statements are not relevant for the assessment in this case either because the Russian President was not involved in the signing of the ECT at the time. The ECT was signed by a government representative. For the sake of completeness, the Russian Federation will nevertheless explain in § 390 et seq. of this Defence on Appeal that HVY's new statements are substantively incorrect as well.

(b)(iv) *Conclusion*

182. The principle of the separation of powers that is enshrined in the Constitution entails that upon the conclusion of legislation the primacy of the legislator must be respected. The Russian government is bound to federal legislation (see Articles 15(2) and 115 of the Constitution). The government is not allowed to issue secondary legislation that deviates from federal law. The government cannot enter into treaty obligations if such obligations deviate from federal laws either. Treaties that deviate from federal laws must be approved by the Parliament.
183. The provisional application of Article 26 ECT leads to a change or addition to existing procedural legislation. This provision furthermore infringes upon the powers of the courts that are laid down in the constitution and the law. The Russian government is not authorised – without the consent of the Parliament – to effectuate that the Russian Federation provisionally applies such an arbitration scheme.
184. The Russian Federation is applying the Treaty provisionally “*to the extent that such provisional application is not inconsistent with its constitution, laws or regulations*” (Article 45 ECT). Because the provisional application of Article 26 ECT is in breach of the principle of the separation of powers in this case, HVY cannot invoke Article 26 ECT and no valid arbitration agreement existed.

(c) *It is inconsistent with Russian Law to submit tax or expropriation disputes to arbitration*

The Russian Federation refers to:		
<u>Arbitrations:</u>		
HEL Interim Award	Chapter VIII.A.4.c	marginal nos. 370-379
<u>Setting aside proceedings:</u>		
Writ	Chapter IV.C.c	§§ 205-240
SoD	Part I, Chapter 3.2.2.	§§ 68-75
	Part II, Chapter 2.1.3	§§ 229-259
SoR	Chapter III.C.d	§§ 152-184

UNOFFICIAL TRANSLATION

This text is an unofficial translation of the Dutch original. In case of any discrepancies, the Dutch original shall prevail.

SoRej	Chapter 2.2.3	§§ 108-112
RF Pleading Notes	Chapter III.2	§ 18
HVY Pleading Notes	Chapter 1.2.1	§§ 38-45
SoA	Part I, Chapter 6.3	§§ 570-592

Primary exhibits:	
<u>Arbitrations:</u>	
	Professor Kostin’s Expert Opinion (which demonstrates that the present dispute is not arbitrable in the Russian Federation)
<u>Setting aside proceedings:</u>	
RF-50	Professor Asoskov’s 2014 Expert Opinion (which demonstrates that the present dispute is not arbitrable in the Russian Federation)
RF-D5	Professor Asoskov’s 2017 Expert Opinion (which demonstrates that the present dispute is not arbitrable in the Russian Federation)
RF-D6	Professor Marochkin’s Expert Opinion (which demonstrates that the present dispute is not arbitrable in the Russian Federation)
RF-D7	Professor Yarkov’s Expert Opinion (which demonstrates that the present dispute is not arbitrable in the Russian Federation)

Essence of the reasoning

In the Arbitration the Russian Federation has advanced three independent arguments on the basis of which arbitration of the present dispute is inconsistent with Russian law. The second argument is that the provisional application of Article 26 ECT is inconsistent with the rule of law that public-law disputes are not arbitrable.

- This dispute pertains to the exercise of public-law authority. Therefore, the dispute is a dispute under public law (section (c)(ii)).
- The District Court correctly ruled that public-law disputes are not arbitrable under Russian law (section (c)(iii)).
- The rule of law that public-law disputes are not arbitrable also applies to international investment disputes (section (c)(iv)).
 - International investment disputes do not constitute a separate category of disputes that are always arbitrable.
 - The Laws on Foreign Investments confirm that public-law investment disputes are not arbitrable.
 - The legislator can formulate an exception to the rule that public-law investment disputes are not arbitrable. HVY were, however, unable to point out any applicable statutory exception or an exception under treaty law.
 - This case in any event does not concern an international investment dispute under

the scope of the Laws on Foreign Investments.

- Thus, arbitration of the legal claims instituted by HVY is inconsistent with Russian laws prescribing that, among other things, tax disputes and expropriation disputes are not arbitrable. As a result, HVY cannot rely on Article 26 ECT and no valid arbitration agreement was concluded.

(c)(i) Introduction

185. In the Arbitration the Russian Federation has advanced three independent arguments on the basis of which arbitration of the present dispute is inconsistent with Russian law. The second argument relates to the fact that Article 26 ECT allows for the arbitration of certain, further specified investment disputes that relate to taxes, execution and expropriation. This mechanism is inconsistent with Russian law. After all, Russian laws provide that tax disputes, execution disputes and expropriation disputes are resolved by the domestic courts. Arbitration of the legal claims brought by HVY is therefore inconsistent with Russian law. As a consequence, Article 26 ECT is not applied provisionally and cannot imply an offer for arbitration.
186. Below, in section (c)(ii), it will be explained that this dispute pertains to the exercise of public-law authority and that the dispute is consequently of a public-law nature. After, it will be explained that, in the Russian Federation (and elsewhere), disputes such as the present one that concern taxes, expropriations, execution and bankruptcy have to be resolved by the domestic court. Such disputes are not arbitrable (see section (c)(iii)).
187. HVY do not really dispute that their claim relates to the exercise of public-law authority. Nor do they dispute that tax disputes and expropriation disputes are not arbitrable under Russian law. Their central argument seems to be that there exists an exception for this international investment dispute. It is explained in section (c)(iv) that Russian legislation shows the opposite.

(c)(ii) This dispute pertains to the exercise of public-law authority (ground 5.41)

188. HVY based their claim on the assertion that Russian tax assessments and the subsequent collection and enforcement measures with respect to Yukos Oil constituted an unlawful

expropriation.²⁵² HVY’s reproaches pertain to the manner in which primarily the Russian Federation’s tax authorities used their powers under public law. In its assessment of the merits of the dispute, the Tribunal considered it decisive that (i) the Russian tax authorities wrongfully imposed VAT assessments and (ii) the Russian authorities wrongfully collected taxes by selling the shares in the capital of the production company Yuganskneftegaz under execution.²⁵³

189. The District Court ruled that it is “*beyond doubt*” that this dispute pertains to the exercise of public-law authority by state bodies of the Russian Federation:

“5.41 (...) The legislative provisions discussed above in any case do not provide for the option of arbitration for disputes arising from a legal relationship between the Russian Federation and (foreign) investors, in which the public-law nature of the Russian Federation’s actions in that relationship is predominant and in which an assessment of the exercise of public-law authorities by Russian Federation state bodies is concerned. In the opinion of the court, it is beyond doubt that such a dispute exists in the current cases. The conduct for which the defendants reproach the Russian Federation cannot be designated as acts carried out by the Russian Federation as an equal party or private-law party. (...)”

As has been considered above, the Arbitration is connected to the previously described mode of action of the Russian Federation, which, in the view of the defendants, constitutes a breach of Article 13 (and Article 10) ECT. The Arbitration concerned a dispute that had arisen from a public-law legal relationship and that centred on compensation for damage caused by the actions of the government. (...)” (emphasis added)

190. The District Court’s ruling is correct. The expert opinion of Professor Asoskov provides an explanation of the manner in which a distinction is made in the Russian Federation between public-law and private-law disputes. A public-law dispute is a dispute (i) involving a public-law legal entity and (ii) relating to the exercise of powers under public law (*jure imperii*).²⁵⁴ In this specific case, the Russian Federation used its powers under public law vis-à-vis Yukos in order to levy and collect taxes. Accordingly, this dispute is of a public-law nature.

²⁵² See the Hulley Statement of Claim, 3 February 2005, §§ 59-76, 80-87 and 101-121. See SoR, § 156, and Professor Asoskov’s 2014 Expert Opinion (**Exhibit RF-50**), which was not substantively disputed on this point. The unsubstantiated assertions to the contrary in the SoRej., §§ 107 and 115, are incorrect.

²⁵³ See Final Awards, marginal no. 1579. Incidentally, this assessment was and is disputed on substantive grounds.

²⁵⁴ Professor Asoskov’s 2017 Expert Opinion (**Exhibit RF-D5**), §§ 11, 13, 21, 53-59, Professor Asoskov’s 2014 Expert Opinion (**Exhibit RF-50**), §§ 25-35.

191. HVY argue that the tax and collection measures by the Russian Federation qualify as an unlawful expropriation. They therefore brought a claim for compensation of damage on the basis of Article 13 ECT. They believe that a choice for particular law provisions entails that their claim cannot be regarded as a public-law claim.²⁵⁵ That said opinion is not correct. What matters is whether this case concerns the exercise of public-law authority.
192. Claims seeking to annul an administrative decree are not the only claims that fall under public law. In the Russian Federation, it is possible for private parties to bring a claim for damages against the State even without claiming annulment of a decree. However, as Professor Asoskov elaborates in his expert opinion, such claims submitted for the purpose of obtaining damages on account of the unlawful exercise of powers under public law are also of a public-law nature.²⁵⁶ Consequently, the exact legal basis of a claim is therefore irrelevant for the question of whether it should be regarded as a claim under public law. Under Russian law, the choice for a specific claim basis (e.g. Article 13 ECT, Article 1 FP-EHCR or the unlawful deed under civil law) does not cause a public-law tax or expropriation dispute to change colour all of a sudden.
193. In other words, the claimant's exact claim or basis thereof is not decisive to whether a dispute should be regarded as a dispute under public law. One cannot convert a public-law procurement dispute into a private-law dispute by invoking a civil-law doctrine. For example, the relationships between municipalities and private parties that pertain to the public procurement of goods or services are generally of a public-law nature. This means that disputes relating thereto are not arbitrable under Russian law, not even if a private party bases its claim (primarily) on an imputable failure to meet one's obligations under an agreement.²⁵⁷

²⁵⁵ The assertion in SoA, §§ 551-558, that a claim based on part III ECT "therefore" does not pertain to alleged violations of Russian public law, is incorrect. Indeed, the bottom line of the entire substantive colouring of their claim and the Tribunal's assessment on the merits is that the use of public-law authorities would be incorrect and in violation of Russian laws and regulations. Contrary to what HVY assert, they have most certainly demanded compensation for alleged violations of Russian public law. The Tribunal has also most certainly ruled on alleged violations of Russian tax law and execution law (in this context, see also §§ 243 and 244 below). One cannot transform a non-arbitrable dispute under public law into an arbitrable dispute under civil law by taking the position that public-law conduct results in a violation of Article 6:162 DCC, Article 1 FP-EHCR or Article 13 ECT. See for an elaborate rebuttal also Professor Asoskov's 2017 Expert Opinion (**Exhibit RF-D5**), §§ 53-76.

²⁵⁶ See Professor Asoskov's 2017 Expert Opinion (**Exhibit RF-D5**), § 67.

²⁵⁷ Resolution by the Presidium of the Russian Supreme Court in Commercial Matters dated 28 January 2014, No. 11535/13 in Case no. A40-148581/12, A40-160147/12, A40-148581/12-25-702 (**Exhibit RF-270**): "*Relations arising from award of contracts are distinguished by a combination of the following*

(c)(iii) *The District Court correctly ruled that public-law disputes are not arbitrable under Russian law (grounds 5.35-5.41)*

194. Public-law disputes, in principle, cannot be submitted to arbitration in most if not all jurisdictions.²⁵⁸ In the Netherlands, for example, most tax disputes (but also bankruptcy and execution disputes) cannot be freely determined by the parties. Consequently, they cannot be arbitrated.²⁵⁹ Professor Scheltema, the intellectual father of the Dutch General Administrative Law Act, wrote:

“(…) [I]n administrative law, the rule is that rights and obligations are not up to the free determination/at the disposal of the parties, or of the government in particular. Therefore, alternative adjudicators cannot have the final say in most administrative-law disputes. Government agencies cannot delegate the powers vested in them to take administrative decisions and the control over the rectitude of those decisions cannot be attributed to others than those to whom those powers are assigned. For example, it cannot be that a tax dispute is assigned to an arbitration tribunal to decide whether a certain service falls under the low VAT rate. If such a decision were binding, it would result in substantial objections when a different decision is reached in other cases, for instance because the case law of the court provides for a different approach. This could stretch or bend the principle of equality in a negative way.” (emphasis added)²⁶⁰

195. The same applies in the Russian Federation. Disputes pertaining to tax assessments, collection measures, enforcement measures, bankruptcy or expropriation by a State are not arbitrable.²⁶¹ In the expert opinions of Professor Asoskov²⁶² and Professor Kostin²⁶³,

specific features: the contract is concluded for the public benefit by a special public body (a state or municipal formation or public establishment), the purpose of its conclusion is to satisfy state or municipal needs, with financing of such needs from respective treasuries. Thus, the contracts executed in accordance with the procedure provided in the Government Procurement Law have a public basis, pursue public interest and are intended to achieve the result necessary for public purposes for the satisfaction of public needs ensured, which is achieved by means of expenditure of public funds. The concentration of so many elements of public interest in one legal relationship make it impossible to recognize the disputes arising from contracts as solely private-nature disputes between private persons that may be adjudicated on a private basis - by arbitral tribunals.”

²⁵⁸ See Writ, § 190. With respect to Germany, see Professor Nolte’s 2016 Expert Opinion (**Exhibit RF-D12**), § 61.

²⁵⁹ See also Article 1020(3) DCCP; Asser, *Procesrecht*/Asser 3 2013, 103, Snijders 2013, Article 1020 DCCP, note 5a. K.J. de Graaf, *Schikken in het bestuursrecht* (diss.) Groningen 2004, p. 27.

²⁶⁰ M. Scheltema, "Toepassing in de Algemene wet bestuursrecht", in: I.C. van der Vlies & S. Pront-Van Bommel (red.), *Van toetsing naar bemiddeling*, Deventer: Kluwer 1997, pp. 75-80, p. 76 (emphasis added).

²⁶¹ Writ, §§ 208-240 and SoR, §§ 150-182.

reference is made to a vast number of specific legal provisions from which this emerges.²⁶⁴ These provisions either appoint the domestic court as the exclusive adjudicator²⁶⁵, or indicate the limited – i.e. only civil-law – instances in which arbitration is permitted. By way of example, a number of these provisions are cited here²⁶⁶:

Statutory provisions designating the domestic court as the exclusive adjudicator:

Article 428 of the Code of Civil Procedure of 1964:

“A claimant or a debtor may file a complaint, and a prosecutor may file a challenge, against court bailiff actions related to the enforcement of a decision or a refusal to perform such actions. Such a complaint or challenge shall be submitted to the court to which that court bailiff is attached or to the judge who made the decision (...).”²⁶⁷

Article 17 of the Law of 27 December 1991 on the Principles of Taxation (No. 2118-1):

“[p]rotection of the rights and interests of taxpayers and the State is exercised by judicial or other procedure provided for by the legislation of the Russian Federation”²⁶⁸

Article 138(1) of the Tax Code (1998):

“the acts of tax authorities, the actions or failure to act of their officials may be challenged before a higher tax authority (higher tax official) or in court.”²⁶⁹

²⁶² See Professor Asoskov’s 2014 Expert Opinion (**Exhibit RF-50**). See also the brief additional report dated 20 October 2015 (**Exhibit RF-203**). Professor Asoskov drew up a new additional opinion for the appeal proceedings (**Exhibit RF-D5**).

²⁶³ See A.A. Kostin, "Opinion on Certain Issues of Arbitrability", dated 21 February 2006, (**Kostin’s Expert Opinion**, submitted in the Arbitrations, **Exhibit RF-03.1.C-1.1.3**).

²⁶⁴ The provisions confer exclusive jurisdiction on a specific court or judge. The Russian Federation contests HVY’s assertion that it was not argued that "*Russian law has a specific provision*" that impedes arbitration (SoA, §§ 549 and 569).

²⁶⁵ To eliminate any possibility of confusion: Russia’s legal system differs from the Dutch legal system in that it does not include any comparable specialist administrative courts (such as the Dutch *Raad van State*, or Council of State). Disputes under administrative law are often handled by the regular courts.

²⁶⁶ See also Professor Asoskov’s 2014 Expert Opinion (**Exhibit RF-50**), §§ 13-21, and the subsequent references to the tax laws, among others. See also Professor Asoskov’s 2017 Expert Opinion (**Exhibit RF-D5**), §§ 24-25 and 46-52, and the legal literature and commentaries cited by Professor Asoskov.

²⁶⁷ English translation of the original Russian text.

²⁶⁸ English translation of the original Russian text.

²⁶⁹ English translation of the original Russian text.

Article 90 of the Federal Law on an Execution Proceeding (1997, No. 199-FZ):

“A claimant or a debtor may file a complaint against court bailiff actions related to the execution of an enforcement document issued by an arbitrazh court (...) to the arbitrazh court at the court bailiff’s location (...). In all other instances a complaint against enforcement actions or a refusal to perform enforcement actions by a court bailiff (...) shall be filed with a court of general jurisdiction at the court bailiff’s location (...).”²⁷⁰

Statutory provisions showing that only civil-law disputes are arbitrable:

Article 27 of the Code of Civil Procedure of 1964:

“In cases provided by law or by international treaties, a dispute arising from civil law relationships, upon agreement of the parties, may be submitted for resolution by an arbitral tribunal (...).”²⁷¹

Article 1(2) of the International Arbitration Law of 1993:

“The following kinds of disputes can be submitted for international commercial arbitration by agreement between the parties: disputes arising from contractual and other civil law relationships arising from the maintenance of foreign trade and other international economic relations, if the commercial enterprise of at least one of the parties is located abroad...”²⁷²

Article 21 of the Code of Civil Procedure in Commercial Matters (Arbitrazh²⁷³) of 1992:

“By agreement of the parties, an economic dispute that has arisen or may arise and that falls within the jurisdiction of arbitrazh courts can be submitted to arbitration before an arbitrazh court has commenced the proceedings.”²⁷⁴

Article 23 of the Code of Civil Procedure in Commercial Matters (Arbitrazh) of 1995:

“By agreement of the parties, a dispute that has arisen or may arise and that arises out of civil law relations and falls within the jurisdiction of arbitrazh

²⁷⁰ English translation of the original Russian text.

²⁷¹ English translation of the original Russian text.

²⁷² English translation of the original Russian text.

²⁷³ The Russian terminology is not always clear to outsiders. An Arbitrazh Court in the Russian Federation is similar to a District Court. So, an Arbitrazh Court is not an arbitral tribunal.

²⁷⁴ English translation of the original Russian text.

courts can be referred to arbitration before it has been resolved by an arbitrazh court.²⁷⁵

Article 1(2) of the Law on Arbitral Tribunals:

“By agreement of the parties to arbitration proceedings (hereinafter referred to as the parties), any dispute resulting from civil law relations may be referred to the arbitration tribunal, unless otherwise provided by the federal law.”²⁷⁶

196. It is also generally assumed in literature that disputes relating to legal relationships under public law, bankruptcy and execution disputes are not arbitrable.²⁷⁷ In 2014, for example, Khvalei wrote a comparative law review article. In this article, Khvalei explains, among other things, that disputes with the State regarding taxation and bankruptcy are not arbitrable under Russian law:

“[D]isputes with the tax authorities concerning payment of taxes are not arbitrable under Russian law, as they arise out of administrative relations. (...)”

In principle, disputes between shareholders of a company and state authorities in connection with the establishment, restructuring and liquidation of legal entities are of a public-law character, and therefore not arbitrable. (...)

The RF Law ‘On Insolvency (Bankruptcy)’ states that bankruptcy cases are reviewed by state arbitrazh courts and may not be referred to arbitration. (...)

[A]fter the court declares a debtor bankrupt and opens bankruptcy proceedings, all claims of creditors relating to monetary obligations may be made only in the framework of bankruptcy proceedings (...) the bankruptcy receiver is also not entitled to submit disputes under transactions which he or she signs during liquidation of the company to arbitration.²⁷⁸

197. Several judicial authorities have confirmed that public-law disputes are not arbitrable.²⁷⁹

For example, the Constitutional Court of the Russian Federation ruled on 26 May 2011:

²⁷⁵ English translation of the original Russian text.

²⁷⁶ English translation of the original Russian text.

²⁷⁷ See Professor Asoskov’s 2017 Expert Opinion (**Exhibit RF-D5**), §§ 46-52 and 69, which also discusses sources of law that were not referred to earlier in these proceedings.

²⁷⁸ Vladimir Khvalei, "Constitutional Grounds for Arbitration and Arbitrability of Disputes in Russia and other CIS Countries", *Journal of Eurasian Law*, 2014 (**Exhibit RF-269**), pp. 165, 168, 169 and 176.

²⁷⁹ See for instance the decision of the Russian Supreme Court in Commercial Matters dated 28 January 2014, No. 11535/13, **Exhibit RF-270**. The Russian Federation contests HVY’s assertion that there is no rule of Russian law that seeks to categorically exclude ‘public-law’ disputes from the entire spectrum of disputes that can be settled by arbitration (SoA, § 566). That rule does exist, as is apparent from the statutory provisions, case law and literature cited above (see Professor Asoskov’s 2017 Expert Opinion (**Exhibit RF-D5**), §§ 46-52). Incidentally, this more general point is not relevant to this case, because it

“The reference to the civil-law nature of a dispute as its arbitrability criterion means that, in the existing system of legal regulation, referral of disputes arising from administrative and other public-law relations to arbitration is not permitted (...)”²⁸⁰

198. The District Court correctly ruled that, in this case, HVY have not contested that disputes of a public-law nature cannot be resolved by arbitration under Russian law:

“5.36. In examining the meaning of these two legislative provisions, the court will first discuss the standpoint of the Russian Federation that other Russian laws have never allowed for arbitration for disputes arising from public-law legal relations. In this context, the Russian Federation pointed out provisions from various Russian laws, a number of which were in force prior to the signing of the ECT while others entered into force more recently. (...)”

5.37. In addition, both Asoskov and Kostin listed legislative provisions which make arbitration conditional on the nature of the dispute. (...)”

5.38. Both Asoskov (in sections 23 and 24 of his expert’s report) and Kostin (on page 3 of his expert’s report) have concluded that public-law disputes cannot be settled by arbitration, referencing various quotations from Russian legal literature.

(...) 5.41. The court follows the analysis in the experts’ reports based on the legal provisions and the references to the Russian doctrine and jurisprudence cited in the two experts’ reports. Incidentally, the defendants did not contest this interpretation of the legal provisions discussed above. (...)” (emphasis added)

(c)(iv) *The rule of law that public-law disputes are not arbitrable also applies to international investment disputes*

(c)(iv)(i) *Introduction*

199. The Russian Federation did not ratify the ECT. As a consequence, Article 26 ECT never entered into force for the Russian Federation. Article 26 ECT contains an arbitration mechanism that (perhaps) makes it possible to submit certain specified investment disputes relating to taxes, enforcement measures and expropriation to arbitration. As has been explained in the foregoing, such disputes are not arbitrable. Arbitration of the legal claims brought by HVY is therefore inconsistent with Russian law.

has not been disputed that the statutory provisions referred to above prove that disputes relating to tax, execution, bankruptcy or expropriation are not arbitrable.

²⁸⁰ Ruling of the Constitutional Court No. 10-P of 26 May 2011, as discussed in Professor Asoskov’s 2017 Expert Opinion (**Exhibit RF-D5**), §§ 46 and 115. English translation of the original Russian text. Incidentally, this ruling was repeated verbatim in a later ruling of the Constitutional Court RF No. 5-O of 15 January 2015.

200. The relevant laws and regulations discussed above make no exception for cases involving a foreign party. Nor do the relevant laws and regulations accept a special rule for investment disputes. In chapter six of their Statement of Appeal, HVY nevertheless argue that the ordinary statutory rules are irrelevant, because international investment disputes are supposedly subject to a special and different regime. To that end, they rely primarily on the Russian Laws on Foreign Investments of 1991 and 1999. It will be explained below (i) that there are no special rules for international investment disputes, (ii) that the laws of 1991 and 1999 in fact confirm that public-law disputes are not arbitrable and that these laws offer no independent basis to submit investment disputes to arbitrators, (iii) that the latter is also evident from the established Russian treaty practice, and (iv) that this dispute in any event is not an international investment dispute.

(c)(iv)(ii) International investment disputes do not constitute a separate category of disputes that are always arbitrable (ground 5.41)

201. HVY assert that there is an exception to the main rule codified in formal laws, stating that disputes arising from public-law juridical acts are not arbitrable, namely all international disputes under a treaty.²⁸¹ According to them, the prohibition on submitting public-law disputes to arbitration within Russian law is “*irrelevant*”, because supposedly this prohibition is only effective within the context of the Russian legal system.²⁸² HVY believe that the Russian statutory provisions containing that prohibition – the Tax Code, Law on Attachments and Executions, Bankruptcy Act, Codes of Civil Procedure, the Civil Code, and Federal Laws on Arbitral Tribunals, and their predecessors – “*do not pertain to*” international arbitration proceedings.²⁸³

202. The District Court rejected HVY’s position. To that end, the District Court considered, among other things, that the aforementioned 1993 International Arbitration Law explicitly provides that only civil-law disputes may be decided by arbitrators. The District Court considered:

“5.41 (...) In this context, [the defendants] limited their defence to the argument that the legal provisions relate only to arbitration within the Russian Federation’s national legal system. Even if their defence were correct – which

²⁸¹ See also SoA, §§ 559, 560 and 599.

²⁸² SoD, Part II, § 258, SoRej., §§ 108-109, and SoA, §§ 553-558.

²⁸³ SoD, Part II, § 254, and SoA, §§ 550-565.

in any case does not hold for the 1993 International Arbitration Law of 1993, which explicitly concerns cases in which one of the parties is not established in the Russian Federation – this does not alter the fact that the Russian legislation mentioned here limits the option of arbitration to civil-law disputes.”

203. The District Court’s ruling is correct.²⁸⁴ Article 1 of the International Arbitration Law explicitly provides that only “*disputes arising from contractual and other civil law relationships*” can be resolved through international arbitration. The comments on this law confirm that this means that disputes with the State about public-law affairs are not arbitrable, not even if they are in any way related to international trade or investments. By way of example, it is pointed out in comments on individual articles of this statutory provision that disputes with customs authorities about customs duties are not arbitrable:

“If a dispute, although arising in the course of foreign trade, has a public-, rather than private-law, nature (for instance, a dispute between an exporter or importer of goods and a customer authority concerning the payment of customs charges), it cannot be accepted for settlement by international commercial arbitration, even though it were agreed so by both parties to the dispute”. (emphasis added)²⁸⁵

204. HVY assert that investment disputes between private investors and the State based on a treaty form an entirely separate category. They are of the opinion that such “international” disputes can never be designated as public-law disputes.²⁸⁶ This assertion fails and is not in any way supported in Russian legislation. There is no such third category of international disputes. Investment disputes are dealt with in exactly the same way as national disputes. They are resolved according to exactly the same legal rules that also apply in other cases. This follows clearly from the applicable Russian laws as well. By way of example, reference can be made to the following decision of a Russian Court of Appeal in which the legislation on this point is summarized clearly and concisely.

“In accordance with Article 4(2) of the RSFSR Law dated 26 June 1991 No. 1488-1 “On Investment Activities in the RSFSR”, the investments made by foreign individuals and legal entities in the RSFSR territory shall be regulated

²⁸⁴ See SoR, §§ 153-158.

²⁸⁵ Commentary on the Law of the Russian Federation “On International Commercial Arbitration”: an article-by-article, scientific practical commentary / edited by Prof. A.S. Komarov, S.N. Lebedev, V.A. Musin. St. Petersburg, 2007, pp. 26-27, as cited in Professor Asoskov’s 2017 Expert Opinion (**Exhibit RF-D5**), § 29.

²⁸⁶ SoA, §§ 550-569.

by this Law and the RSFSR Law “On Foreign Investments”, as well as by other legislative acts applicable in the RSFSR territory.

According to Article 6(1) of the RSFSR Law dated 26 June 1991 No. 1488-1 "On Investment Activities in the RSFSR", entities involved in investment activities shall comply with the norms and standards whose establishment procedure is determined by the legislation of the USSR, the RSFSR, and republics within the RSFSR.

Besides, as follows from Article 15(1) of the same Law, the state shall guarantee protection of investments, including foreign ones, in accordance with the legislation applicable in the RSFSR territory.

Thus, provisions of Russian legislation on bankruptcy shall be applied to the legal relationship between the Bank being a legal entity constituted and based in Austria and Bummash Company, in connection with the bankruptcy of the latter.

The circumstance that the Bank is a foreign legal entity does not affect the content of such relationship and does not require ensuring the Bank’s interests in a legal treatment being different from the one applied to other bankruptcy creditors.” (emphasis added)²⁸⁷

205. It is generally assumed in Russian literature and case law that international investment disputes between investors and the State can and must also be subdivided into disputes that can and disputes that cannot be arbitrated.²⁸⁸ In his expert opinion, Professor Asoskov discusses various examples of concrete cases in which courts designate international (investment) disputes with the States as disputes of a public-law or a civil-law nature, and in which they subsequently adjudicate the disputes on the basis of the (procedural) rules governing such disputes.²⁸⁹ In exceptional cases, it is conceivable that disputes with the State resulting from civil-law relationships between the State and an investor are designated as disputes under private law. Such disputes are, in principle, arbitrable. Most investment disputes, however, are of a public-law nature. Investment disputes with the State that relate to the issue of a permit, tax assessment, unequal treatment or expropriation

²⁸⁷ See Exhibit RF-271, Resolution of the Seventeenth Commercial Court of Appeal of 29 December 2012, No. 17AP-4510/11. English translation of the original Russian text.

²⁸⁸ See Professor Asoskov’s 2014 Expert Opinion (Exhibit RF-50), §§ 67-71, Professor Asoskov’s 2017 Expert Opinion (Exhibit RF-D5), §§ 68-69, in which Asoskov refers to the works of Krupko and Doronina, among others. The assertion in SoA, §§ 550-569, to wit that disputes involving a reliance on international treaties form their own category and by definition cannot qualify as public-law disputes, is nonsense. There is no basis whatsoever for this assertion in law or literature.

²⁸⁹ See Professor Asoskov’s 2017 Expert Opinion (Exhibit RF-D5), §§ 62-66.

must be designated as disputes governed by public law.²⁹⁰ Such investment disputes are not arbitrable under Russian law.

206. The essence of this case is that the underlying dispute pertains to Russian taxes imposed by the Russian authorities on a Russian business. Such a dispute is not arbitrable under Russian law, which is evident from very specific and clear statutory provisions.²⁹¹ That the claimants in this case are three letterbox companies with their official seats outside the Russian Federation does not alter this. None of the aforementioned laws formulate an exception for parties that coincidentally have their registered office outside the Russian Federation. That such an exception does not follow from an applicable treaty either is explained below (see §§ 229-232).²⁹²

(c)(iv)(iii) *The Laws on Foreign Investments confirm that public-law disputes are not arbitrable and offer no independent basis to submit investment disputes to arbitration (grounds 5.42-5.64)*

Introduction

207. The Russian Federation provisionally applies the Treaty "*to the extent that such provisional application is not inconsistent with its constitution, laws or regulations*" (Article 45 (1) ECT). Numerous provisions of Russian law showing that this dispute, which pertains to the exercise of public-law powers (such as imposing taxes), is non-arbitrable are cited above. This means that arbitration of this dispute pursuant to Article 26 ECT is inconsistent with Russian law. This is confirmed by the Laws on Foreign Investments.
208. In 1991, the USSR issued a Fundamentals Act pertaining to foreign investments. This Fundamentals Act was implemented in 1991 on the level of the Russian Soviet Federative

²⁹⁰ See Professor Asoskov's 2017 Expert Opinion (**Exhibit RF-D5**), §§ 68-69.

²⁹¹ This was even acknowledged; see SoA, § 566. HVY's assertion that there is no specific statutory regulation on the basis of which investment disputes are not arbitrable is incorrect and, moreover, irrelevant. The essence is that it concerns disputes pertaining to taxation, execution, bankruptcy and alleged expropriation. Naturally, the mere assertion that a taxation measure is also an expropriation within the meaning of Article 13 ECT does not mean that a tax dispute suddenly changes and is no longer based in public law. See also § 191 above.

²⁹² For a refutation of the incorrect legal interpretations underlying HVY's assertions, the Russian Federation refers to the expert opinion by Professor Asoskov. For an elaboration of the defence against SoA, §§ 550-569, see, among other things, Professor Asoskov's 2017 Expert Opinion (**Exhibit RF-D5**), §§ 73-76, where Professor Stephan's expert opinion is discussed. Professor Asoskov explains that Professor Stephan basically refers only to examples relating to conflicts between states and/or international organisations.

Socialist Republic by means of the Law on Foreign Investments.²⁹³ In 1999, the Russian Federation issued a renewed version of the Law on Foreign Investments. The Fundamentals Act and the 1991 and 1999 Laws on Foreign Investments confirm that disputes regarding sovereign actions of government are not arbitrable absent a ratified treaty.²⁹⁴

The Fundamentals Act of 1991

209. The Fundamentals Act was intended as a guideline that should be used by the individual states of the Soviet Union in the enactment of legislation.²⁹⁵ This Fundamentals Acts therefore shows some similarities with European guidelines that are implemented by member states of the European Union in their national legislation.
210. The Fundamentals Act makes a clear distinction between (i) public-law disputes that must be resolved exclusively by the domestic courts (Article 43(1)), and (ii) disputes arising from private-law relationships that may possibly be submitted to arbitration (Article 43(2)):

“1. Disputes between foreign investors and the State are subject to consideration in the USSR in courts, unless otherwise provided by international treaties of the USSR.

2. Disputes of foreign investors (...) with Soviet State bodies acting as a party to relationships regulated by civil legislation (...) are subject to consideration in the USSR in courts or, upon agreement of the parties, in arbitration proceedings (...).²⁹⁶

211. Of course, the Fundamentals Act of 1991 is important in the interpretation of the Law on Foreign Investments of 1991.²⁹⁷ After all, the Law of 1991 discussed below concerns an

²⁹³ Judgment, ground 5.23. See also Writ, § 223, and SoR, § 169.

²⁹⁴ See Writ, §§ 222-232, and SoR, §§ 164-173. The Russian Federation disputes the statements in SoA §§ 574-588.

²⁹⁵ The Fundamentals Act of 5 July 1991, No. 2302-1 (R-902).

²⁹⁶ English translation of the original Russian text.

²⁹⁷ See Professor Asoskov’s 2017 Expert Opinion (**Exhibit RF-D5**), §§ 98-101. HVY wrongfully argue that the laws of 1991 and 1999 should not be read in conjunction with the Fundamentals Act (SoA, §§ 688-691). However, as HVY’s expert acknowledges, the Fundamentals Act was intended to make it clear to the republics that were part of the Soviet Union that they had to implement laws that were in line with the principles enshrined in this Fundamentals Act (SoA, § 690). Consequently, it makes sense to involve this Fundamentals Act in the interpretation of the law of 1991. That the Soviet Union was dissolved in December 1991 does not affect the fact that the Fundamentals Act is highly important in the interpretation of the Law of 1991. By way of comparison: if the United Kingdom were to leave the European Union, the interpretation of some laws would still be based on the underlying European directives.

implementation of the Fundamentals Act at the level of one of the member states of the Soviet Union.

The Law on Foreign Investments of 1991

212. The Law on Foreign Investments of 1991 confirms that disputes relating to expropriation should be resolved exclusively by the regular domestic courts.²⁹⁸ In this respect, the Law is entirely in accordance with the Soviet Union's treaty practice at the time.²⁹⁹

213. Specifically, Article 7(3) of the Law of 1991 provides that decisions by government bodies on the expropriation of foreign investments can be contested "*in the RSFSR courts*".³⁰⁰ Hence, Article 7(3) of the Law of 1991 leaves no doubt that HVY's claims on the basis of Articles 13 and 26 ECT are inconsistent with Russian law:

"Decisions of governmental bodies on expropriation of foreign investments may be contested in the RSFSR courts."³⁰¹

214. It follows from Article 7 that the domestic court has exclusive jurisdiction to hear expropriation disputes.³⁰² By way of example, Asoskov refers to a comment from 1992, which makes it clear that – if an investor wants to appeal to a decision on an objection – this appeal must be lodged with the District Court:

"In accordance with the law of the RSFSR [on foreign investments, 1991] (Art. 7), foreign investments may be requisitioned in public interests in exceptional cases stipulated by legislative acts. The Law of the RSFSR does not specify the public authority competent to take requisition decisions.

²⁹⁸ The Law on Foreign Investments of 4 July 1991, No. 1545-1.

²⁹⁹ Professor Asoskov's 2017 Expert Opinion (**Exhibit RF-D5**), §§ 87-89. See also § 149 above. For a more detailed description of the Russian treaty practice, see §§ 441 et seq.

³⁰⁰ Law on Foreign Investments (1991), Article 7(3) (Professor Asoskov's 2014 Expert Opinion (**Exhibit RF-50**), Annex 30): "*Decisions of governmental bodies on expropriation of foreign investments may be contested in the RSFSR courts.*" See also SoR, § 165.

³⁰¹ Original English text.

³⁰² HVY's assertion in SoA, § 696, that Article 7(3) creates no exclusive jurisdiction is incorrect and is hereby contested. This assertion is only supported by the view of Professor Stephan, the expert who was engaged by HVY itself and who (wrongly) attributes significance to the word "may". As explained by Professor Asoskov in his expert opinion, this view of Stephan is incorrect and is not supported by the Russian legislation and literature (see Professor Asoskov's 2017 Expert Opinion (**Exhibit RF-D5**), §§ 82-86). The word "may" is used repeatedly in these and other laws and only makes it clear that an investor is not obliged to challenge a decision. The word "may" thus indicates that the investor has a choice to apply to the domestic court. If an investor wishes to do so, only the domestic court will be competent to hear the dispute.

However, it establishes that the authority where such actions should be appealed shall be the court.³⁰³

215. Article 9 of the Law of 1991 confirms that only private-law disputes can be submitted to arbitrators. Article 9 of the Law of 1991 implements Article 43 of the Fundamentals Act. Article 9(1) confirms that investment disputes are resolved exclusively by the domestic courts.³⁰⁴ However, disputes with the State that pertain to civil-law relationships can, in principle, be submitted to arbitration. This – as is generally assumed – follows from Article 9(2) of the Law of 1991.³⁰⁵

“1. Investment disputes, including disputes over the amount, conditions and procedure of the payment of compensation, shall be resolved by the Supreme Court of the RSFSR or the Arbitrazh Courts³⁰⁶ of the RSFSR, unless another procedure is established by an international treaty in force in the territory of the RSFSR.

2. Disputes of foreign investors and enterprises with foreign investments against RSFSR State bodies, disputes between investors and enterprises with foreign investments involving matters relating to their operations, as well as disputes between participants of an enterprise with foreign investments and the enterprise itself shall be resolved by the RSFSR courts, or, upon agreement of the parties, by an arbitral tribunal, or, in cases specified by the laws.” (emphasis added)³⁰⁷

216. The Tribunal ruled – without further analysis or substantiation – that the text of Article 9 of the Law of 1991 is “*crystal clear*” and supposedly shows that all investment disputes are always arbitrable.³⁰⁸ The District Court addressed the interpretation of Articles 7 and 9 of this law in detail, with reference to relevant Russian literature. The District Court rightly³⁰⁹ concluded that disputes regarding public-law actions of government must be submitted to

³⁰³ English original text. See Khlestova’s comment, as referred to in Professor Asoskov’s 2017 Expert Opinion (**Exhibit RF-D5**), § 86.

³⁰⁴ Law on Foreign Investments (1991), Article 9(3) (Professor Asoskov’s 2014 Expert Opinion (**Exhibit RF-50**), Annex 30). See also Writ, § 230, SoR, § 172, and Professor Asoskov’s 2014 Expert Opinion (**Exhibit RF-50**), §§ 81-95. Along the same lines, see: Professor Asoskov’s 2017 Expert Opinion (**Exhibit RF-D5**), §§ 90-104.

³⁰⁵ See Professor Asoskov’s 2014 Expert Opinion (**Exhibit RF-50**), §§ 75-79, and Professor Asoskov’s 2017 Expert Opinion (**Exhibit RF-D5**), §§ 79-104.

³⁰⁶ In Russian, the term Arbitrazh Courts is used. For the record: this concerns domestic courts.

³⁰⁷ English translation of the original Russian text.

³⁰⁸ HEL Interim Award, marginal no. 370.

³⁰⁹ See also SoR, §§ 166-170.

the domestic courts on the basis of Article 9(1) of the Law of 1991.³¹⁰ Articles 7 and 9 thus confirm that arbitration of this dispute is inconsistent with Russian laws. The District Court rightly concluded that Article 9 does not provide an “*independent legal basis for arbitration*”:

"5.51. Based on the considerations stated here, the court concludes that Article 9 paragraph 1 concerns (civil-law) disputes arising from legal relations between foreign investors and the Russian Federation in which the public-law nature predominates. The scope of application of Article 9 paragraph 2, on the other hand, is limited to investment disputes of a predominantly civil-law nature. This is in line with the distinction made by Russian jurisprudence and doctrine, as described in section 5.36 et seq. in this judgment. The Tribunal did not acknowledge this distinction. Instead, it limited itself to the representation of Article 9 paragraph 2 in the Interim Awards and subsequently drew the conclusion that disputes between an investor and a state can be settled by arbitration according to Russian law. The court deems this opinion incorrect. (...) The Arbitration concerned a dispute that had arisen from a public-law legal relationship and that centred on compensation for damage caused by the actions of the government. This finding means that the option of arbitration is not determined by Article 9 paragraph 2, as was the reasoning of the Tribunal, but by the first paragraph of Article 9. In view of the fact that Article 9 paragraph 1 favours proceedings before the Russian court for civil-law disputes arising from public-law legal relationships and only provides for other modes of dispute resolution if a treaty provides for it, this provision does not offer an independent legal basis for arbitration between the defendants and the Russian Federation."

217. The District Court's decision is correct and is essentially endorsed by Professor Stephan, the expert of HVY. He recognizes that the Law of 1991 provides no independent offer of submitting investments disputes to arbitrators (“*[i]t did not provide a free-standing consent for international arbitration*”).³¹¹

The Law on Foreign Investments of 1999

218. With the introduction of the Law on Foreign Investments of 1999, the legislator did not intend to introduce substantive changes that relate to dispute resolution through arbitration. Consequently, the Laws of 1991 and 1999 largely support the same approach.³¹²

³¹⁰ Article 9(1) makes it clear that a treaty that entered into force for the Russian Federation may contain an exception to the main rule that investment disputes are not arbitrable. The ECT never entered into force for the Russian Federation; see Article 44 ECT. HVY's assertions in SoA, §§ 581-582, are incorrect. In this context, see also Professor Asoskov's 2017 Expert Opinion (**Exhibit RF-D5**), §§ 113 et seq.

³¹¹ Stephan's Expert Opinion, § 190 (HVY Exhibit D3).

³¹² Professor Asoskov's 2017 Expert Opinion (**Exhibit RF-D5**), § 106.

219. Unlike the Law of 1991, the Law on Foreign Investments of 1999 does not contain any specific provision demonstrating which investment disputes are arbitrable.³¹³ It merely contains a general reference to other federal laws and treaties.³¹⁴ Article 10 of the Law of 1999 provides the following:

“A dispute of a foreign investor arising in connection with its investments and business activity conducted in the territory of the Russian Federation shall be resolved in accordance with international treaties of the Russian Federation and federal laws in courts, arbitrazh courts or through international arbitration (arbitral tribunal).”³¹⁵

220. The Tribunal ruled that the Laws on Foreign Investments are “*crystal clear*” and show that all disputes between an investor and a State are always arbitrable.³¹⁶ However, as the District Court rightfully remarked, the Tribunal did not devote even a single separate consideration to Article 10 of the Law on Foreign Investments of 1999 or its interpretation.³¹⁷

221. In grounds 5.52-5.58 of the Judgment, the District Court rules that Article 10 of the Law on Foreign Investments of 1999 contains only a general reference to federal laws and treaties. In other words: investment disputes are resolved in the same manner and in accordance with the same rules as any other dispute. Entirely in accordance with the Russian literature cited by it, the District Court concludes that Article 10 of the Law on Foreign Investments of 1999 offers no independent legal basis for international arbitration to resolve disputes between an investor and a State:

“5.53. The Tribunal did not devote a separate consideration to the meaning of Article 10. Here, too, the Tribunal limited itself to the opinion that, based on Article 10, disputes between an investor and a state, such as is the case in the current proceedings, can be settled by arbitration. The court does not share this opinion either, for the following reasons. (...)”

³¹³ The Russian Federation contests the assertions in SoA, §§ 586-587, the essence of which is that Article 10 supposedly does offer an independent basis for arbitration.

³¹⁴ See also Writ, § 230, SoR, §§ 172-173, Professor Asoskov’s 2014 Expert Opinion (**Exhibit RF-50**), §§ 81-95, and Professor Asoskov’s 2017 Expert Opinion (**Exhibit RF-D5**), §§ 105-110.

³¹⁵ Federal Law no. 160-FZ "On Foreign Investments in the Russian Federation" (9 July 1999), Article 10 (Professor Asoskov’s 2014 Expert Opinion (**Exhibit RF-50**), Annex 31, English translation of the original Russian text) (emphasis added).

³¹⁶ HEL Interim Award, marginal 370.

³¹⁷ Judgment, ground 5.53.

(...) 5.56. Article 10 is characterised by a general reference to both treaties and federal laws that could create authorities for regular courts to settle disputes involving foreign investors, but also for ‘arbitrazh tribunals’ and for international arbitration between foreign investors and the Russian state. Article 10 therefore does not create a direct legal basis for the arbitration of disputes on obligations of Part III of the ECT, but rather makes the option of arbitration conditional upon the existence of a provision in treaties and federal laws to that effect. The court agrees with the Russian Federation that the nature of Article 10 provides for a ‘blanket provision’ or a *mutatis mutandis* clause (‘*schakelbepaling*’ in Dutch). This interpretation of Article 10 is in line with the perceptions in Russian doctrine mentioned by Asoskov. (...)

5.58. Based on the foregoing, the court arrives at the opinion that Article 10 of the Law on Foreign Investments 1999 does not provide a separate legal base for the arbitration of disputes between an investor and a state in international arbitral proceedings, as provided for in Article 26 ECT. Therefore, the court does not follow the Tribunal’s opinion that such disputes, and therefore also the current dispute, can be arbitrated based on Russian law.” (emphasis added)

222. The District Court’s decision is correct and is essentially endorsed by Professor Stephan, the expert of HVY. He recognizes that the Law of 1999 does not contain any independent legal basis that makes it possible to submit international investment disputes to arbitrators (“*it does not by its own terms mandate international arbitration of investment disputes*”).³¹⁸

The Russian Federation has confirmed on multiple occasions that the Laws on Foreign Investments do not provide for international arbitration (ground 5.64)

223. The Russian government confirmed on multiple occasions prior to the Arbitrations that the Laws on Foreign Investments do not provide for arbitration. See, for example, (a translation of) the Explanatory Memorandum to the Parliament for the legislation to approve an investment treaty with Argentina:

“Considering that the Agreement contains provisions different from those provided by the Russian legislation, it is subject to ratification in accordance with 15(1)(a) of the Federal Law (...) ‘on International Treaties of the Russian Federation’ (...)

The key issues by virtue of which the above Agreement is subject to ratification are as follows (...)

the settlement in an international arbitration court of investment disputes between one Party and an investor of the Other Party, as well as disputes

³¹⁸ Stephan’s Expert Opinion (HVY Exhibit D3), § 207.

between the Parties concerning the interpretation and application of the Agreement (...)

the Federal Law No. 1545-1 of July 4, 1991 ‘On Foreign Investment in the RSFSR’ does not provide for a mechanism of settlement of such type of dispute by international arbitration”. (emphasis added)³¹⁹

224. Similar quotes can be found in parliamentary papers pertaining to investment treaties concluded with South Africa, Japan, Macedonia, Egypt, Syria and Yemen, among others.³²⁰ Unlike the Tribunal, the District Court addressed the parliamentary history of such treaties in detail. On the basis thereof, the District Court concludes in ground 5.64 that the Laws on Foreign Investments do not provide for arbitration in the cases referred to in Article 26 ECT:

“5.64. These explanatory notes support the opinion that the Law on Foreign Investments in the versions of 1991 and 1999 does not contain a legal provision for arbitration in cases as referred to in Article 26 ECT, such as the current case. (...) The provided parliamentary notes can only be taken to mean that the versions of the Law on Foreign Investments of 1991 and 1999 do not contain any type of legal basis for investment arbitrations such as the ones in these proceedings. If arbitration had been permitted under this law, the arbitration provisions in the investment treaties concluded by the Russian Federation would not have been designated as ‘provisions different from those provided by the Russian legislation’ and ratification would not have been deemed necessary. (...)” (emphasis added)

(c)(iv)(iv) *Public-law investment disputes are not arbitrable under Russian law, unless a federal law or an approved treaty provides for an exception (ground 5.64)*

Exceptions must follow unambiguously from an act or treaty

225. Naturally, a law passed by the Duma or a treaty ratified by the Duma³²¹ can create an exception to the rule codified in procedural law that tax disputes, execution disputes and

³¹⁹ Explanation of the Issue of ratification of the Agreement between the Government of the Russian Federation and the Government of Argentina concerning the Promotion and Reciprocal Protection of Investments (25 October 1999) (R-402), original English text (emphasis added).

³²⁰ See Writ, §§ 232-234, SoR, §§ 177-182, and Professor Asoskov’s 2017 Expert Opinion (**Exhibit RF-D5**), §§ 127-130.

³²¹ See SoR, §§ 163-174. This is confirmed by the BIT practice, see SoR, §§ 175 et seq. Of course, the treaty must be ratified. In this context, see Professor S. Yu. Marochkin’s expert opinion discussed below, "Interpretation to references to ‘International Treaties’ in the Russian Federation’s 1991 and 1999 Statutes on Foreign Investment", dated 24 October 2017 (**Professor Marochin’s Expert Opinion, Exhibit RF-D6**).

bankruptcy disputes are not arbitrable.³²² In general, exceptions must be laid down unambiguously in formal laws or ratified treaties and the scope of such exceptions must be interpreted restrictively.³²³

226. Moreover, the Russian Federation also made it clear multiple times prior to the institution of the Arbitration Proceedings in 2005 that international investment disputes must be submitted to the domestic courts.³²⁴ For example, the Minister of Energy of the Russian Federation offered an official report to the ECT Secretariat in 2004. In clear wording, the report makes it clear that, in the Russian Federation, only the domestic courts are authorised to take cognisance of disputes.³²⁵ Exceptions should follow from a law or ratified treaty.³²⁶
227. In other words: without a well-defined exception or an exception under treaty law, it is inconsistent with Russian law to submit a public-law investment dispute for arbitration.³²⁷ In this case, it is therefore up to HVY to demonstrate the existence of an exceptional provision in a federal act or ratified³²⁸ treaty that offers an independent legal basis for

³²² Compare the statements in SoA, §§ 593-595.

³²³ See Professor Marochkin's Expert Opinion (**Exhibit RF-D6**), section C. See Professor Asoskov's 2017 Expert Opinion (**Exhibit RF-D5**), §§ 115, 116, 119-126.

³²⁴ Contrary to what HVY believe, the Russian Federation never guaranteed that all investment disputes are arbitrable (SoA, § 588). In fact, several documents confirm that disputes must be resolved by the domestic courts (see § 330 below).

³²⁵ HVY believe that, in this report, the Russian Federation confirmed that "*all investment disputes may be resolved by arbitration*" (SoA, § 168). That is incorrect. The reliance on this memorandum in SoA, § 588 holds no water either. The report confirms that investment disputes must be resolved in a manner corresponding with the laws and treaties of the Russian Federation. Russian Federation, Investment Climate and Market Structure in the Energy Sector (C-008), p. 53: "*(...) Any disputes of foreign investor arising in connection with effecting investments or his or her business activity in the territory of the Russian Federation shall be settled according to the international agreements and federal laws of the Russian Federation in court or arbitration or in the international court of arbitration.*"

³²⁶ Russian Federation, Investment Climate and Market Structure in the Energy Sector (C-008), p. 36. "4.2. National legal system 4.2.1. General provisions (...) Justice in the Russian Federation is administered only by courts established in accordance to the Constitution of the Russian Federation and the Federal Constitutional Law mentioned above. The creation of extraordinary courts and courts that are not envisaged by this Law is not permitted. (...) The creation of extraordinary courts and courts that are not envisaged by this Law is not permitted (...)."

³²⁷ HVY's assertion that the Russian Federation concludes investment treaties with arbitration clauses and that it is therefore compatible with Russian law to subject all investment disputes to arbitration even without a treaty to that effect is consequently incorrect (SoA, §§ 596-598).

³²⁸ See also SoR, §§ 164 et seq., Professor Asoskov's 2014 Expert Opinion (**Exhibit RF-50**), §§ 69 et seq. The ECT did not enter into force for the Russian Federation (see Article 44 ECT). Had the ECT been ratified and entered into force, this would of course have provided, in a permissible manner, an exception to the formal main rule in Article 9(1) of the Law of 1991, among others, that tax disputes must be

submitting the present (public-law) dispute to arbitrators. They have not succeeded in this, as will be explained below. The reason for this is simple: there is no such exceptional provision.

HVY were unable to demonstrate any statutory exception or an exception under treaty law on the basis of which this dispute is arbitrable

228. Russian legislation does not contain any exceptional provision on the basis of which the present dispute would be arbitrable. Such a provision does not exist in the Laws on Foreign Investments cited repeatedly by HVY.³²⁹ As HVY's expert acknowledges, these laws contain no independent basis or offer to submit public-law (investment) disputes to arbitrators.³³⁰
229. HVY were also unable to point out a ratified treaty that offers a legal basis for submitting the present dispute for arbitration. Russian law has well-defined and restrictive exceptional provisions under treaty law. The Russian Federation is a party to a number of investment treaties ratified by the Russian Parliament, which treaties in specific cases provide for a limited widening of options to submit disputes to arbitration. The arbitration scheme in the investment treaty between the Netherlands and the Russian Federation, discussed above, is a clear example of that.³³¹ However, such treaties do not apply in this case and HVY have not relied on them either.
230. HVY argue that the existence of (other) well-defined exceptions under treaty law entails that Russian law "*in a general sense*" allows international (public-law) disputes to be resolved under a treaty.³³² They believe that arbitration on a public-law dispute under Article 26 ECT is "therefore" allowed under Russian law. This reasoning does not hold water for several reasons.

submitted to the domestic courts. HVY's assertions in SoRej., §§ 109 and 111, SoD, §§ 254 and 258, and SoA, §§ 581-582, are incorrect. The Tribunal's considerations in HEL Interim Award, marginal nos. 370 and 381-385, are also incorrect. In this context, see also Professor Marochin's Expert Opinion (**Exhibit RF-D6**).

³²⁹ See Writ, §§ 232-234, and SoR, §§ 177-182.

³³⁰ See also §§ 207-221 above.

³³¹ See § 149 above. For a more detailed description of the Russian treaty practice, see §§ 441 et seq.

³³² See SoA, §§ 598-600.

231. First: HVY presume that the Russian Federation is bound by Article 26 ECT. They pretend that Article 26 ECT has come into force and conclude on the basis thereof that “therefore” there exists a valid exception to the legal rule that public-law disputes are not arbitrable. With such a circular reasoning, HVY fail to recognize that the question whether Article 26 ECT should be applied is a question pending resolution before this Court. Pursuant to Article 45 ECT, the Russian Federation is merely applying the Treaty provisionally “*to the extent that such provisional application is not inconsistent with its constitution, laws or regulations*”. Russian laws do not permit the resolution of this public-law dispute through arbitration. This means that, pursuant to Article 45 ECT, the Russian Federation is not required to provisionally apply Article 26 ECT in this case.
232. Second: HVY furthermore fail to recognize that a valid exception to the statutory rule that public-law disputes are not arbitrable can be created only if a treaty has been ratified and has entered into force. This by itself already follows from the hierarchy of legal rules within the Russian legal system. The government cannot unilaterally bring about a deviation from federal law. This also follows from Article 15(4) of the Russian Constitution (see §§ 419-434 below). The ECT was not ratified and did not enter into force, and may therefore not create exceptions to federal laws.
233. Third: As is apparent from the expert opinions of Professors Marochkin and Asoskov, it follows from the Laws on Foreign Investments that the ECT in any event cannot formulate a “legal exception” to the main rule that tax disputes and expropriation disputes are not arbitrable³³³: After all, the ECT was not ratified and consequently does not have priority:
- (a) Articles 9(1) and (3) of the Law of 1991 explicitly provides that disputes are resolved under federal laws and treaties that have entered into force on the Russian Federation’s territory. The ECT has neither been ratified nor entered into force in the territory of the Russian Federation. HVY are apparently trying to escape the unambiguous text of Article 9 of the Law of 1991 by

³³³ See for example Professor Asoskov’s 2017 Expert Opinion (**Exhibit RF-D5**), § 39: “[I]n the commentary to Article 1(2) of the Civil Procedural Code of the Russian Federation, it is noted that the priority over the rules of this Code is given only to the rules of an international treaty, by which the consent to be bound was expressed in the form of a federal law: “[A] court, in disposal of legal proceedings, may not apply the provisions of the law regulating the relevant legal relations if an international treaty effective for the Russian Federation, the consent to be bound by which was given by the Russian Federation in the form of a federal law, lays down other rules than those provided in the law. In these instances, the provisions of the international treaty of the Russian Federation shall apply.” (emphasis added)

suddenly – after twelve years of litigation – employing an entirely different translation of the Russian word “действующих”.³³⁴ Regardless of the propriety of this change of course, Professor Marochkin’s elaborate expert opinion demonstrates that the legislator intends to refer to treaties to which the Russian Federation has expressed its consent to be bound.³³⁵ In a case like this, ratification by federal law is therefore required. Because the ECT has not been ratified, the Treaty cannot formulate a valid exception to the main rule that public-law disputes are not arbitrable.

- (b) Article 10 of the Law of 1999 provides that disputes are resolved in accordance with the current federal legislation and “*international treaties of the Russian Federation*”. As Professor Marochkin explains in his expert opinion, the term “*international treaties of the Russian Federation*” has been defined in Article 2 FLIT. This definition demonstrates that it concerns treaties in respect of which consent was given to be bound by the treaty. In this case, that means that ratification by the Russian Parliament in a federal law is required. Since the ECT was not ratified, it does not qualify as an international treaty of the Russian Federation.³³⁶ Article 10 thereby confirms that this dispute is not arbitrable.

³³⁴ The Russian text uses the word " Действующим". In the Arbitrations, HVY submitted a frequently-used English translation of the Law of 1991 (C-1537). The translation they submitted at the time is a more or less official translation that was already drafted in 1991 and that has been reprinted and used extensively. In the said translation, the Russian words have been translated into English as "*international agreement in force*." In the first instance, HVY repeatedly cited this translation (see, among others, SoD I.69, § II.233, and footnotes 503 and 505). Now, after twelve years of litigation and without any further explanation, HVY suddenly opt for an entirely different translation: "*an international treaty in effect*" (see SoA, § 577, footnote 430). There is no reason to do so. The official Russian-language version of the Vienna Convention on the Law of Treaties employs the terms "действующих положений" and "в силе", which are both translated as "*in force*". HVY apparently follow a translation devised by Professor Stephan himself. Because Professor Marochkin discusses Professor Stephan’s report, the English translation of the counter report also uses the "*in effect*" translation. There was no substantive consideration underlying this practice. In any event, it is apparent from Professor Marochkin’s report, it is crystal clear – irrespective of which translation one chooses – that the legislator intended to refer to treaties in respect of which the Russian Federation expressed its consent to be bound by the treaty (Professor Marochin’s Expert Opinion, **Exhibit RF-D6**, section C.1).

³³⁵ Professor Marochin’s Expert Opinion (**Exhibit RF-D6**), §§ 15-62. The exact formulation in Article 9 of the Law of 1991 was – as demonstrated by the legislative history – carefully selected. The intention was to make it clear that it concerns treaties to which either the USSR or the Russian Federation has given its consent to be bound.

³³⁶ Professor Marochin’s Expert Opinion (**Exhibit RF-D6**), §§ 15-44 and 62-66.

(c) It should be noted that the above is in line with the general manner in which laws are designed in the Russian Federation. Russian federal laws often seek to regulate a certain subject matter comprehensively. As a result, many federal laws contain provisions the essence of which is that a specific statutory provision may be deviated from by treaty. In literature, it is generally assumed that such provisions are, strictly speaking, redundant given the text of the Constitution. For example, Professor Makovskiy wrote that Article 15(4) of the Russian Constitution is “*unnecessarily repeated in many dozens of statutes*”.³³⁷ Such statutory provisions – like Article 9 of the Law of 1991 and Article 10 of the Law of 1999 – refer back to the complete hierarchy of standards as apparent from Article 15 of the Constitution (see §§ 232 and 419-434). Consequently, they refer only to treaties that have been approved by the Parliament.³³⁸

234. Finally: The Russian Federation made it clear that the ECT cannot provide a basis for submitting disputes for arbitration (see in particular §§ 326-335 below). As discussed previously, the Russian Federation prepared a report in 2004 and sent it to the ECT Secretariat.³³⁹ This report was intended to give investors insight into Russian laws and regulations. The report makes it clear that it follows from Russian legislation that disputes with the State can be settled exclusively by the domestic courts. However, the report does indicate that investment treaties of the Russian Federation can provide for arbitration. The report itself contains a long list of all the relevant investment treaties pertaining to the energy sector. It is telling that the ECT is not mentioned on the list.³⁴⁰ The report clarifies that treaties deviating from Russian (federal) legislation must be ratified.³⁴¹ The ECT was

³³⁷ See Professor Makovsky, as cited in Professor Asoskov’s 2017 Expert Opinion (**Exhibit RF-D5**), § 35: “*In this regard, Professor A.L. Makovskiy, who is one of the developers of the Russian Federation’s Civil Code and many other legislative acts, observes that Article 15(4) of the Constitution of the Russian Federation ‘has become unnecessarily repeated in many dozens of statutes, enacted in individual instances.’*”

³³⁸ See Professor Asoskov’s 2017 Expert Opinion (**Exhibit RF-D5**), §§ 31-35 and 117-118.

³³⁹ See § 226 above.

³⁴⁰ Russian Federation, Investment Climate and Market Structure in the Energy Sector (C-008), p. 33. HVY constantly seem to assume that Article 26 ECT applies in full. That is of course impossible. The question is whether the provisional application of Article 26 ECT is compatible with Russian law. That is not the case, because Russian law provides that public-law disputes must be submitted to the domestic courts.

³⁴¹ The report also emphasises that treaties deviating from existing legislation must be ratified. Russian Federation, Investment Climate and Market Structure in the Energy Sector (C-008), p. 34: “(...) In

not ratified. The report from 2004 therefore confirms that the provisional application of Article 26 ECT is inconsistent with Russian law.

(c)(iv)(v) *This case in any event does not concern an international investment dispute under the scope of the Laws on Foreign Investments*

235. This is a case of Russian Oligarchs against the Russian Federation, relating to tax measures imposed in Russia on a Russian company. There was never any “foreign investment” by a “foreign investor” on Russian territory (see also chapters III and IV.C below). The Laws on Foreign Investments of 1991 and 1999 – which HVY explicitly rely on – do not even apply in this case. This is where HVY’s most important grounds for appeal fail. For this reason alone, this Court of Appeal can brush the entire sixth chapter of the Statement of Appeal and the expert opinion of Professor Stephan aside as irrelevant.³⁴²
236. The Laws on Foreign Investments of 1991 and 1999 seek – as demonstrated by the preamble – to attract foreign capital goods.³⁴³ Consequently, they apply only when an investor contributes foreign capital in the territory of the Russian Federation. Article 2 of the law of 1999 provides: “Foreign investment means the injection of foreign capital in an object of business activity in the territory of the Russian Federation (...)”³⁴⁴ The Russian Federation refers to the expert opinion of Professor A.G. Lisitsyn-Svetlanov, the substance of which is not disputed by HVY, which shows that there is only question of a foreign investment if assets have actually been injected in the territory of the Russian Federation and have therefore led to an increase of capital in the territory of the Russian Federation.³⁴⁵ According to established Russian case law, as is apparent from Professor V.V. Yarkov’s

accordance with the Constitution of the Russian Federation, ratification of international treaties of the Russian Federation is carried out by adopting a federal law. International treaties and agreements of the Russian Federation that result in changing or modifying the legislation in force or the adoption of new federal laws providing rules other than those stipulated by laws in force, are subject to ratification.”

³⁴² Stephan Expert Opinion (HVY Exhibit D3).

³⁴³ See Professor V. Yarkov’s expert opinion, dated 27 November 2017 (**Professor Yarkov’s Expert Opinion, Exhibit RF-D7**), §§ 10, 14.

³⁴⁴ Article 2 of the Law on Foreign Investments of 1999 (R-178), English translation of the original Russian text (emphasis added). See also Article 2 of the Law of 1991 (R-176): “Foreign investments are all types of assets and intellectual valuables injected by foreign investors into objects of business and other types of activity.” (emphasis added).

³⁴⁵ Expert Opinion of Professor A.G. Lisitsyn-Svetlanov dated 22 February 2006 (**Lisitsyn-Svetlanov’s Expert Opinion**, submitted in the Arbitrations, **Exhibit RF-03.1.C-1.1.2**), previously cited in the Writ, § 220.

expert opinion, there is no question of an “investment” if shares are transferred with a view to avoiding or evading taxes.³⁴⁶

237. The Russian Federation has stated – and HVY have not contested – that HVY never made an actual investment in the Russian Federation that injected assets in the territory of the Russian Federation (see also chapters III and IV.C below).³⁴⁷ On the contrary, Hulley, Veteran and YUL were in fact incorporated to fraudulently³⁴⁸ withdraw money from the Russian Federation and place it in tax havens. This way, billions worth of dividend payments were drained from the Russian Federation in late 2003 (see also §§ 607-614 below).³⁴⁹
238. In the first instance proceedings, HVY devoted – in their own words – “*barely any*”³⁵⁰ attention to the statement that the Laws on Foreign Investments are not applicable. The Russian Federation's argument was supposedly, “*clearly inadequate in so many respects*”.³⁵¹ The only casual remark that HVY made in this context in the first instance is that “*Article 26 is the legal basis for the arbitration of HVY’s claims*”³⁵² and that the Laws on Foreign Investments “*do not prohibit anything (...) that is allowed under the ECT*”.³⁵³ This argument is incomprehensible and the Russian Federation cannot find any reasoning or defence in it.³⁵⁴ Apparently, HVY simply assume that Article 26 ECT applies in full. In doing so, they (again) fail to recognise that the question of whether Article 26 ECT applies

³⁴⁶ See Professor Yarkov’s Expert Opinion, (**Exhibit RF-D7**), § 29.

³⁴⁷ Writ, §§ 219-221, 255(b), and SoR, § 161. If any money was ever invested, this was money that originated from the Russian Federation. At most, this was a circulation of funds that never led to an increase of assets in the Russian territory.

³⁴⁸ The Tribunal established that Hulley filed fraudulent tax returns to evade dividend taxes due; see Final Award, marginal 1620. In this context, see also the extensive expert opinion of Professor S. van Weeghel, Professor of International Tax Law at the University of Amsterdam, dated 29 January 2007 (submitted by the Russian Federation in the Arbitrations to the Respondent’s Second Memorial on Jurisdiction), which shows that Hulley and Veteran wrongfully relied on the tax treaty between Cyprus and the Russian Federation.

³⁴⁹ Final Awards, marginal nos. 840, 844 and 869. The Tribunal explains that Yukos Oil distributed approximately USD 2 billion in interim dividend for 2003. Hulley and Veteran received the lion’s share thereof. On 8 December 2003, Yukos Oil paid the dividend to Hulley.

³⁵⁰ SoD, Part II, footnote 499.

³⁵¹ In the SoD, this argument is touched on in only a single footnote (SoD, Part II, footnote 499), while the defence against this argument in the SoRej. contains only three sentences (see SoRej., § 116, first bullet).

³⁵² SoRej., § 116, first bullet.

³⁵³ SoD, Part II, footnote 499.

³⁵⁴ See SoR, § 161.

must in fact first be resolved. They ignore the essential preliminary question: is Article 26 ECT inconsistent with the Russian “*constitution, laws or regulations*”? This question cannot be answered on the basis of the Treaty text alone. The defence cannot serve either as a refutation of the assertion that the arbitration of acts governed by public law is not permitted (see §§ 207-224 above).³⁵⁵ What matters is that the opinion of the Tribunal (and HVY’s argument) already fails because it is based on Laws on Foreign Investments that do not apply here.

239. The Russian Federation's point (that the Laws on Foreign Investments do not apply) went uncontested by substantiating arguments in the first instance. In the appeal, HVY have not addressed the scope of application of the Laws on Foreign Investments at all, nor (given the two-statement rule) can HVY now remedy this shortcoming in their Statement of Appeal.

(c)(v) *Conclusion*

240. Article 26 ECT contains an arbitration mechanism that makes it possible to submit certain disputes that pertain to acts under public law (such as tax disputes, execution disputes and expropriation disputes) to arbitration. Because the Russian Federation did not ratify the ECT, Article 26 ECT never entered into force for the Russian Federation.
241. The Russian Federation is applying the Treaty provisionally “*to the extent that such provisional application is not inconsistent with its constitution, laws or regulations*” (Article 45 ECT). Russian laws provide that public-law disputes (such as tax disputes, execution disputes and expropriation disputes) may be resolved exclusively by the domestic courts. Arbitration of the legal claims brought by HVY is therefore inconsistent with Russian law. As a result, HVY cannot rely on Article 26 ECT and therefore no valid arbitration agreement was concluded.

(d) ***It is inconsistent with Russian laws for shareholders to bring a claim in connection with damage caused to the company***

The Russian Federation refers to:

Arbitrations:

HEL Interim Award

Chapter VII.A.4.c

marginal no. 372

³⁵⁵ Incidentally, the assertion that these laws “*prohibit something or prohibit nothing*” is not relevant. It is up to HVY to point out an exception based on which this tax and expropriation dispute would still be arbitrable in spite of explicit prohibitory provisions. No such exceptions can be found in these laws.

UNOFFICIAL TRANSLATION

This text is an unofficial translation of the Dutch original. In case of any discrepancies, the Dutch original shall prevail.

Final Awards	Chapter X.D	marginal nos. 1579-1580
<u>Setting aside proceedings:</u>		
Writ	Chapter IV.C.c	§§ 241-244
SoD	Part II, Chapter 2.1.3	§§ 260-266
SoR	Chapter III.C.d	§§ 183-185
SoRej	Chapter 2.2.3	§§ 123-124
RF Pleading Notes		
HVY Pleading Notes		
SoA		

Primary exhibits:		
<u>Arbitrations:</u>		
	Sukhanov	Expert Opinion
<u>Setting aside proceedings:</u>		
	Timmermans & Simons	Expert Opinion

Essence of the reasoning

In the Arbitration the Russian Federation has advanced three independent arguments on the basis of which arbitration of the present dispute is inconsistent with Russian law. The third and final argument is that the provisional application of Article 1 and 26 ECT is inconsistent with the legal rule that shareholders cannot claim damages on account of damage inflicted to the company by third parties.

- Russian law does not afford shareholders the right to claim compensation for a drop or loss in value of shares due to damage caused to the company by third parties.
- The Russian Federation is merely applying the Treaty provisionally “*to the extent that such provisional application is not inconsistent with its constitution, laws or regulations*”. Russian laws prohibit shareholders from bringing a claim such as HVY’s. As a result, HVY cannot rely on Article 1 ECT in conjunction with Article 26 ECT and therefore no valid arbitration agreement was concluded.

(d)(i) *Russian law does not allow HVY to claim compensation for damage allegedly caused to Yukos Oil*

242. The third independent ground showing that arbitration of the present dispute is inconsistent with Russian law relates to Russian liability law and corporate law. Under Russian law, a shareholder cannot bring a legal claim in connection with damage caused to the

company.³⁵⁶ The Russian Federation’s assertions on this point have not been genuinely contested by HVY. No defence was put forward in the first instance that needs to be addressed in these proceedings because of the devolutive effect of this Appeal. Nor does the Statement of Appeal provide any defence. In light of the, “in principle strict rule”, HVY cannot correct this shortcoming in their Statement of Appeal any more by putting forward new arguments at a later stage in these proceedings (two-statement rule). This Court of Appeal can therefore simply conclude, based on this independent ground, that arbitration of HVY’s claims is inconsistent with Russian law.

243. In this case, it is beyond doubt that HVY have brought claims pertaining to special impairment or loss of their shares as a result of damage allegedly caused to Yukos Oil exclusively. This is also apparent from the Tribunal’s assessment. In the assessment of this case on the merits, the Tribunal itself attributed decisive importance to (i) the VAT assessment imposed on Yukos Oil by the Russian Federation, and (ii) the sale under execution of Yukos Oil’s shares in the capital of the production company Yuganskneftgaz.³⁵⁷

244. The Tribunal explicitly ruled that there was no expropriation of shareholders in this case. According to the Tribunal, the key issue in this case concerns the damage allegedly caused to Yukos Oil:

“Respondent has not explicitly expropriated Yukos or the holdings of its shareholders, but the measures that Respondent has taken in respect of Yukos, set forth in detail in Part VIII, in the view of the Tribunal have had an effect ‘equivalent to nationalization or expropriation’”. (emphasis added)³⁵⁸

245. In many civil law systems, shareholders of companies cannot bring claims on account of impairment or loss of shares due to damage caused to a company. The Dutch Supreme Court, for example, ruled in the *ABP v. Poot* case:

³⁵⁶ Given the devolutive effect of the appeal, the Russian Federation’s assertions in this context in the first instance are also relevant. See also Writ, §§ 241-244, and SoR, §§ 183-185.

³⁵⁷ Final Awards, marginal 1579. The Tribunal ruled that without these two measures, Yukos Oil would not have gone bankrupt. It has been explained elsewhere in this Defence on Appeal that the Tribunal’s ruling holds no water in this regard. The tax assessments and collection measures by the Russian Federation were a natural reaction to the most flagrant case of tax evasion in modern history.

³⁵⁸ Final Awards, marginal 1580.

“[...] companies with limited liability are legal persons that independently participate in legal transactions as carriers of their own rights and duties [...] even if they are controlled by a single person (sole shareholder and sole director). The assets of the company are separated from those of its shareholders. If a third person inflicts damage to a company (...), only the company is entitled to claim compensation of the damage inflicted to it from the third person.

That financial damage incurred by the company will, as long as it remains uncompensated, cause a decrease in the value of the shares of the company. In principle, however, the shareholders themselves are not entitled to claim damages for the loss that they suffered from the aforementioned third party. (...)³⁵⁹

246. Nor can shareholders, under Russian law, bring a claim for compensation of financial damage inflicted to the company due to impairment or loss of their shares.³⁶⁰ For the sake of brevity, the Russian Federation refers to the expert opinion of Professor Sukhanov, Professor of Corporate Law at the Lomonosov Moscow State University. In his expert opinion of 22 February 2006, he explained that it follows from the Russian Civil Code and the Law on Public Limited Companies that the right to bring a claim is reserved to the person whose rights have been infringed or denied. Sukhanov explains that, under Russian law, a company fills an independent position and may independently contest damage inflicted to the company. A shareholder cannot bring a legal claim against a third person with which this shareholder has no direct legal relationship.³⁶¹ Professor Sukhanov’s conclusions read as follows:

“13. (...) [U]nder the current Russian legal rules, the shareholder lacks the possibility to bring claims against persons (entities) that have caused damages to the joint stock company in which it participates. (...)

20. (...) [T]he fact that participation of a legal entity (including a joint stock company) in proprietary relations may result in damages affecting proprietary interests of its participants (shareholders) cannot in itself serve as a ground for the latter to seek compensation for the damages inflicted upon the joint stock company directly from the third persons, with whom the shareholders do not have any legal relations.

21. From the point of view of current Russian law, the joint stock company, as well as its shareholders are legally independent subjects - owners of their

³⁵⁹ Supreme Court 2 December 1994, *NJ* 1995, 288 (*ABP/Poot*) ground 3.4.1, as also cited in Writ, § 241.

³⁶⁰ See Writ, §§ 241-244, and SoR, §§ 183-185.

³⁶¹ See also Dr Timmermans and Professor Simons’ expert opinion dated 3 November 2017 (**Timmermans and Simons’ Expert Opinion, Exhibit RF-D8**), §§ 44-48.

property. This provision prevents the shareholders from bringing claims against counter-parties of the joint stock company, i.e. persons (entities) with whom they have no proprietary (civil) relations, seeking compensation of the damages caused to the property of the relevant joint stock company.”³⁶²

247. The Tribunal brushed aside the arguments of the Russian Federation³⁶³ without any substantiation. The Tribunal did not consider the fact that the scope of provisional application of the Treaty was limited by Russian laws and regulations. The Tribunal merely ruled as follows:

“On the issue of standing, the Tribunal concludes that Claimant is claiming for violation of its own rights under the ECT, not the rights of Yukos. The Tribunal agrees with Claimant’s characterization of its claim, which is not a derivative action, but an action for the direct loss by Claimant of its shares and their value.”³⁶⁴

248. The Tribunal's ruling that HVY filed a claim on account of “*direct loss*” is incomprehensible. The Tribunal explicitly acknowledged that there was no expropriation of shareholders themselves (see § 244 above). Against that background, it cannot be understood why there would be “*direct loss*” under Russian law.³⁶⁵ The ruling furthermore fails to acknowledge that claims such as HVY’s, regardless of how the Tribunal qualifies them, are inconsistent with Russian law.³⁶⁶

249. To further substantiate the fact that the Tribunal’s assessment is incorrect, the Russian Federation refers to an expert opinion by Dr W.A. Timmermans and Professor W. Simons, enclosed.³⁶⁷ In short, they confirm the accuracy of Professor Sukhanov’s expert opinion:

“39. (...) Article 225.8 of the RF APK states that a shareholder can only bring a law suit if such is provided for *expressis verbis* by a federal law (...)

³⁶² Professor Sukhanov’s expert opinion (**Sukhanov’s Expert Opinion**, submitted in the Arbitrations, **Exhibit RF-03.1.C-1.1.5**).

³⁶³ See the Hulley First Memorial On Jurisdiction, §§ 110-113. The Russian Federation’s arguments are summarised in HEL Interim Award, §§ 71 (no. 21), 145-149, 358 (third bullet), 360 and 363-364. Similar arguments were included in the Arbitrations of YUL and VPL.

³⁶⁴ Original English text.

³⁶⁵ See Timmermans and Simons’ Expert Opinion, (**Exhibit RF-D8**), §§ 19-33. They conclude that the loss suffered by shareholders, which is the result of (alleged) unlawful conduct vis-à-vis the company, cannot be designated as direct loss under Russian law.

³⁶⁶ See Writ, §§ 241-244, and SoR, §§ 183-185.

³⁶⁷ Timmermans and Simons’ Expert Opinion, (**Exhibit RF-D8**).

42. Outside the scope of the limited number of actions defined by law, a shareholder does not have an express right, under the law, to pursue his own direct interest when claiming damages. A remedy, such as an action to claim damages (ubytki) resulting from a diminution of share value due to a defendant's behaviour, has not been provided for under Russian law. (...)

47. Fully in line with the Expert Report of Professor Sukhanov, there is a broad consensus in the Russian-language legal literature that shareholders cannot bring claims for depreciation of the value of their shares against third persons who committed allegedly wrongful acts against the joint-stock company. See e.g. the works - (cited in arbitrary order) - of Yarkov, Chernyshov, Dedov, Gureev, Dolinskaia and Faleev, Zhurbin, Nagoeva, and Osipenko (...)

48. The underlying claims of HVY seem to constitute an action (...) against a third party (the Russian Federation) for depreciation of the value, or loss, of their shares due to actions taken against Yukos. We conclude that there is a broad consensus that such actions are not allowed under Russian law.³⁶⁸

250. The Russian Federation's positions and Professor Sukhanov's expert opinion were not substantively contested by HVY in the first instance or on appeal. As a consequence, HVY cannot rely on any arguments presented in the first instance (devolutive effect). Nor can they now add to the defences in their Statement of Appeal (two-statement rule). In the first instance, HVY only mentioned in passing that, under Article 1(6) and (7) ECT and Article 26 ECT, an investor may bring its "own" claim on account of the loss in value of shares.³⁶⁹ This is a circular reasoning.³⁷⁰ Apparently, HVY simply assume that Article 1 and Article 26 ECT apply in full as if the Treaty had entered into force. In doing so, they fail to recognise the actual question under consideration: does Article 45 ECT mean that HVY can rely on the broad powers that Articles 1 and 26 ECT confer on shareholders to bring claims on account of impairment or loss of shares? As stated, the answer to this question is no.

(d)(ii) Conclusion

251. Articles 1 and 26 ECT contain an arrangement that – in specific cases – does enable shareholders to bring a claim on account of impairment or loss of shares. Because the Russian Federation did not ratify the ECT, these treaty provisions never entered into force

³⁶⁸ The quote in the main text is from Timmermans and Simons' Expert Opinion (**Exhibit RF-D8**), §§ 39, 42 and 47-78.

³⁶⁹ SoD § II.262 and SoRej. § 124.

³⁷⁰ See also SoR, § 185.

for the Russian Federation. The Russian Federation was merely applying the Treaty provisionally “to the extent that such provisional application is not inconsistent with its constitution, laws or regulations” (Article 45 ECT). Russian laws prohibit shareholders from bringing a (derivative) claim such as HVY’s. As a result, HVY cannot rely on Article 1 in conjunction with Article 26 ECT and therefore no valid arbitration agreement was concluded.

D. HVY’s other – previously rejected or entirely new – arguments cannot succeed

Essence of the reasoning

These appeal proceedings pertain to whether the District Court’s finding that the Tribunal had no jurisdiction to take cognisance of this dispute is based on sound grounds. HVY’s Statement of Appeal primarily contains arguments that the Tribunal previously irrevocably rejected, as well as newly devised arguments. Such arguments are irrelevant to the assessment, and only complicate this case needlessly.

- The majority of HVY’s arguments must be disregarded in view of the limited nature of these setting aside proceedings. In setting aside proceedings under Article 1065 (1)(a) DCCP, a court may only review the Arbitral Tribunal’s positive decisions on jurisdiction (section (b)).

Grounds for jurisdiction rejected by the Tribunal may not be addressed in the setting aside proceedings.

Grounds for jurisdiction not previously put forward in the Arbitrations may not be addressed in the setting aside proceedings.

- The arguments of HVY fail on substantive grounds as well.

The District Court correctly ruled that a reliance on Article 45(1) ECT does not require a prior declaration pursuant to Article 45(2) ECT (section (c)).

A reliance by HVY on acquiescence and estoppel is untenable (section (d)).

HVY’s reliance on the *pacta sunt servanda* principle cannot succeed (section (e)).

HVY’s interpretation of the words “not inconsistent” is untenable (section (f)).

HVY’s arguments regarding the broad powers of President Yeltsin fail (section (g))

(a) ***Introduction***

252. A State’s consent to arbitration must be “clear and unambiguous”. The key question in these proceedings is whether such clear and unambiguous consent by the Russian

Federation is implied in the arbitration clause of Article 26 ECT. As explained above, the District Court in The Hague rightfully ruled that the Russian Federation did not consent to arbitration under the terms of Article 26 ECT. The Judgment of the District Court of The Hague is correct and should be upheld.

253. In this chapter, the Russian Federation discusses the different arguments advanced by HVY. The majority of those must be disregarded in view of the limited nature of a setting aside proceeding. The Russian Federation will successively discuss the following topics:

- (a) The majority of HVY's arguments with respect to the Tribunal's jurisdiction cannot be discussed in these setting aside proceedings (see §§ 254 et seq. below).
- (b) The District Court correctly ruled that a reliance on Article 45(1) ECT does not require a prior declaration (see §§ 280 et seq. below).
- (c) HVY's reliance on acquiescence, estoppel and the *pacta sunt servanda* principle is untenable and was rightly rejected by the Tribunal (previously rejected argument, see §§ 305 et seq. below).
- (d) The District Court rightly rejected the reliance on the *pacta sunt servanda* principle (see §§ 365 et seq. below).
- (e) HVY's interpretation of the words "not inconsistent" is untenable (new argument, see §§ 371 et seq. below).
- (f) HVY's arguments regarding the broad powers of President Yeltsin fail (new argument, see §§ 387 et seq. below).

(b) ***The majority of the arguments of HVY cannot be discussed in these proceedings***

(b)(i) *Introduction: the scope of the setting aside proceedings is limited*

254. The setting aside proceedings are not appeal proceedings where the disputes between the parties can be discussed in full. It does not offer a full re-examination to correct all prior mistakes and omissions. This applies to both the claimant and the defendant in the setting aside proceedings.

255. It will be explained below that the legal system does not allow a party to the proceedings to appeal to the court against a "negative" ruling on the jurisdiction – the rejection of a ground for jurisdiction advanced by it – of an arbitral tribunal. Such a ruling constitutes an

established fact in setting aside proceedings. Only a ruling by which an arbitral tribunal assumed jurisdiction can be contested in setting aside proceedings by the defendant in the arbitration (the Russian Federation). The domestic court in setting aside proceedings cannot replace the ground for jurisdiction assumed by the arbitral tribunal with a different ground for jurisdiction.

256. It will furthermore be explained that HVY is not allowed to introduce entirely new arguments in the setting aside proceedings. Two key arguments should be disregarded for that reason. This primarily follows from the statutory framework: in setting aside proceedings the judge only scrutinizes the decision on the basis of which the tribunal assumed jurisdiction. As a result, wholly new grounds for jurisdiction – that the Tribunal did not and could not assess – cannot be dealt with in setting aside proceedings. Moreover, (i.e. in the alternative) the same conclusion follows from the principles of due (arbitral) process. The main idea behind Dutch legislation – that has been expressly codified in the mean time – is that parties should raise grounds for jurisdiction timely during the arbitration. If a party fails to do so, his right to do so at a later point in time has elapsed.

(b)(ii) The District Court correctly ruled that HVY cannot file a cross claim to against a ruling on jurisdiction that is unfavourable to them (ground 5.25)

257. It follows from the legal system that it is only possible to contest a “positive decision on jurisdiction” given by an arbitral tribunal. After all, Article 1052(4) and (5) and Article 1065 DCCP show that only decisions whereby an arbitral tribunal *assumes jurisdiction* can be contested in setting aside proceedings.³⁷¹

“Article 1052

(...) 4. The decision whereby the arbitral tribunal assumes jurisdiction can be contested only in conjunction with a subsequent full or partial final award and only by means of the legal remedies stated in Article 1064(1).

5. If the arbitral tribunal declines jurisdiction, the ordinary court will have jurisdiction to take cognisance of the case (...)

Article 1065

1. Setting aside is possible only on one or more of the following grounds: a. No valid arbitration agreement exists (...)"

³⁷¹ See SoR, § 189, with reference to Article 1052(5) DCCP, Meijer, *T&C Rv [Text & Commentary DCCP]*, Article 1052 DCCP, annotation 6d.

258. The legal system is in line with the central idea that the fundamental right of access to the court is only affected when an arbitrator assumes jurisdiction. Only in those cases must the jurisdiction of arbitrators be assessed fully by the court.³⁷² Also see the Expert Opinion of Professor Snijders:

"53. As the District Court found at 5.25, our arbitration law, as enshrined in particular in the legal system laid down in Article 1052(4) and (5) DCCP, only provides for the possibility for domestic courts to review the correctness of a tribunal's 'positive' jurisdiction decisions (in their entirety). Only these decisions require intervention by a domestic court insofar as those decisions are incorrect: the issue is to protect the fundamental right to access to justice (as dispensed by the domestic courts). It must be possible for domestic courts to review whether that fundamental right was in fact waived on the ground on which the tribunal assumed jurisdiction."³⁷³

259. However, if an arbitral tribunal *declines* jurisdiction, Articles 1052(5) and 1067 DCCP provide that the ordinary court will have jurisdiction to take cognisance of the case. In that case, setting aside proceedings are not necessary to safeguard the access to the domestic courts. Setting aside proceedings therefore cannot be instituted (as follows from Article 1052(5) DCCP).³⁷⁴ The ordinary court will have to follow the ruling of the incompetent arbitral tribunal.³⁷⁵ The Explanatory Memorandum to the Dutch Arbitration Act 1986, which applies in this case, is clear on this as well³⁷⁶:

³⁷² See Supreme Court 26 September 2014, ECLI:NL:HR:2014:2837 (*Ecuador/Chevron & Texaco*).

³⁷³ Cf. Professor Snijders' Expert Opinion, §53 (Exhibit RF-D9).

³⁷⁴ This does not even take into account the fact that, under the old, applicable Arbitration Act, it is not uncontroversial to consider a declaration declining jurisdiction a judgment or award. Following the view that a declaration declining jurisdiction is not a judgment or award, such a declaration is by definition not contestable and/or not open to any legal remedy. Even following the other view, a declaration declining jurisdiction is only considered a judgment or award when it comes to the enforcement – the order for costs. See Snijders, *Nederlands Arbitragerecht*, 2011, Art. 1052 DCCP, annotation 5 and Meijer, *T&C Rv*, Art. 1052 DCCP, annotation 6a.

³⁷⁵ All this can also be derived from the new Arbitration Act (2015), where the *remission* to the arbitral tribunal during setting aside proceedings (when the court of appeal believes there is a ground for setting aside that can be remedied) is impossible if there is no arbitration agreement. For this, see the parliamentary history on the Arbitration Act 2015, p. 161: "*An arbitral award that can be set aside shall not be remitted if there is no valid arbitration agreement. In that case, the parties have not agreed to valid arbitration, thereby removing one of the requirements for arbitration and making remission to arbitration impossible.*" Neither the arbitral tribunal nor the ordinary court in setting aside proceedings can remedy the lack of a valid arbitration agreement. In addition, the domestic court is required to adopt the tribunal's opinion on this point.

³⁷⁶ Meijer & Van Mierlo, *Parliamentary History Arbitration Act*, Art. 1052, p. 723. See also The Hague District Court, 15 August 2010, ECLI:NL:RBSGR:2012:BX6825: "4.7. *The court believes that this part of Adria's claim [for setting aside] is admissible, as it does not seek a remedy against a declaration declining jurisdiction. Indeed, Adria's complaint is based on the assertion that the arbitral tribunal committed a procedural error whereby it reconsidered a previous decision that had already acquired*

“According to the fifth paragraph, the jurisdiction of the ordinary court is revived in case the arbitral tribunal declines jurisdiction. Therefore, no proceedings before the domestic court whereby it is requested to rule that the arbitral tribunal does have jurisdiction.”

260. See also Professor Snijders and Professor Meijer:

“d. The proceedings are started before an arbitral tribunal, which declines jurisdiction. This is the only case in which the domestic court must respect that decision and therefore does not have the final word or at least no word different than the arbitral tribunal’s with regard to jurisdiction. Unless agreed otherwise, the domestic court has jurisdiction in that case. See Art. 1052(5) DCCP.”³⁷⁷

"44. Given that, under Article 1052(5) DCCP, the domestic court is required to adopt the tribunal's opinion, as discussed above at §18(d) with regard to tribunals' opinions on their lack of jurisdiction in general, this serves to prevent any incongruence between tribunals and the domestic courts. It also promotes harmony between justice as dispensed by the courts and private justice, ultimately to the benefit of all. It does not prejudice any fundamental interest regarding access to justice as dispensed by the domestic courts – in fact, the domestic court only adopts the tribunal's decision declining jurisdiction, which then grants jurisdiction to the court."³⁷⁸

“After all, the arbitral tribunal’s ruling declining jurisdiction is final. The ordinary court plays no part in that assessment. Unless agreed otherwise, a declaration declining jurisdiction means that the ordinary court has jurisdiction” (Art. 1052(5) DCCP).³⁷⁹

261. The following example serves as an illustration of this legal system as it applies in the present case:

- (a) Briefly and simply put, HVY have raised two grounds for jurisdiction allegedly derived from Article 45 ECT: ground A (the Russian Federation did not issue a declaration pursuant to Article 45(2) ECT and is therefore bound to arbitration) and ground B (the Russian Federation must apply Article 26 ECT provisionally pursuant to Article 45(1) ECT).

authority of res judicata between the parties. Adria's claim therefore pertains to the arbitral tribunal honouring a prior decision rather than contesting the declaration declining jurisdiction itself. That the decision reconsidered by the arbitral tribunal pertains to the jurisdiction of the arbitral tribunal does not change this fact."

³⁷⁷ H.J. Snijders, *Nederlands Arbitragerecht*, 2011, Art. 1052 DCCP, annotation 1.

³⁷⁸ Professor Snijders' Expert Opinion, §18(d) and §44 (**Exhibit RF-D9**).

³⁷⁹ Meijer 2011, 11.4.4.4, p. 911.

- (b) The Tribunal rejected ground A. The Tribunal declined jurisdiction on that ground. The Tribunal did assume jurisdiction on ground B.
- (c) Thus, had only ground A been raised, the Tribunal would have declined jurisdiction and this would not have been open to appeal according to the law. The same applies if the Tribunal had declined jurisdiction on both grounds. Indeed, a declaration declining jurisdiction cannot be appealed. Hence, the court cannot rule any differently than the Tribunal did.
- (d) Naturally, this does not change because the Tribunal rejected ground A but assumed jurisdiction on ground B. If ground for jurisdiction B is then lost (because the arbitral award is set aside on that point, as in this case), that leaves only the *lack* of jurisdiction on ground A. This declaration declining jurisdiction cannot be appealed according to the law.³⁸⁰

262. The full and incautious review under ground (a) of Article 1065(1) DCCP means that the ordinary court will fully *review* the arbitral tribunal's positive decision on jurisdiction; was *that* decision on jurisdiction on that ground correct or not? That is where the court's responsibility ends.³⁸¹ The ordinary court cannot shove a different ground for jurisdiction under the arbitral award just like that.³⁸² It remains – as the word itself implies – merely a *review*. The ordinary court indeed only assesses whether the tribunal has given a correct judgment on its jurisdiction. There can be no question of an entirely new, independent

³⁸⁰ This is different only if the Tribunal assumed "positive" jurisdiction on yet another independent ground.

³⁸¹ Contrary to HVY's assertion (see SoA, §637), the 'provisional' ruling does not apply in cases where the tribunal has rejected a particular ground for jurisdiction: in these cases, the regular court is required to adopt the Tribunal's ruling. See also Professor Snijders's Expert Opinion, §46 (**Exhibit RF-D9**): "*As the foregoing implies, that view is incorrect in cases where the tribunal has rejected a particular ground for jurisdiction. The domestic court cannot subsequently assume that the tribunal after all did have jurisdiction on that ground that the tribunal itself had rejected.*"

³⁸² In this respect, it holds that the position taken by Advocate-General Wesseling-van Gent in her Opinion preceding Supreme Court 27 March 2009, ECLI:NL:HR:2009:BG4003, as referred to in § 638 of the SoA, needs to be qualified. The Supreme Court did not adopt this position, as it did not discuss part 3 of the cassation complaint. Contrary to the opinion of the Advocate-General, the Supreme Court deemed Part 2 of the cassation complaint well-founded. The decision in the case *Nusselder/Liquidatiekas* (NJ 1993/97) does not provide support the quote in the Advocate-General's opinion on which HVY rely. Moreover, the specific complaint in cassation and the negative opinion in this context of the Advocate-General related to something different from what HVY suggest, i.e. a requalification by the Court of Appeal asserted and disputed by the claimant (HPB) of what it construed as the ground indicated by the Tribunal regarding the binding force of the arbitral clause: 'joining' instead of 'taking over' the contractual relationship with the defendant (claimant in the arbitration). See also Professor Snijders' Expert Opinion, (**Exhibit RF-D9**), §§47 and 59..

assessment of the jurisdiction of a tribunal based on explicitly rejected (or new, later-conceived or previously undiscussed) arguments.³⁸³

263. This also relates to the fact that *no* devolutive effect applies in setting aside proceedings in respect of what has been advanced in the arbitration on the jurisdiction of the Tribunal.³⁸⁴ In such proceedings, the dispute will not be passed on to the ordinary court again in full – which is contrary to a regular appeal against a court decision.³⁸⁵ The ordinary court can only *assess* and then reject or allow the claim for setting aside.
264. Once it has been established that the Tribunal has assumed jurisdiction on a false ground, the arbitral award will have to be set aside. This is also in line with the case law on the subject of setting aside, which provides that a judgment *by definition* must be set aside once a violation of the principle of hearing both sides of the argument has been established, such regardless whether this violation actually affected the final outcome.³⁸⁶
265. Therefore, HVY cannot claim the setting aside of parts of the Yukos Awards that are unfavourable to them. It follows from the same legal system that it cannot argue either that the Tribunal wrongly declined jurisdiction on the basis of grounds of jurisdiction they did not previously put forward (see also § 268 et seq.). If a claim by HVY for (partial) setting aside would even be possible – which it is not – it alternatively holds that they should have included this claim in their first written statement in the first instance, as stipulated in

³⁸³ The position to the contrary in the SoA, § 641, is incorrect. See, for example, also the Court of Appeal in The Hague 31 March 2015, ECLI:NL:GHDHA:2015:713 (*Slotervaartziekenhuis*): "For the interpretation and assessment of the arbitral award, the contents of that arbitral award must be taken as a starting point. The answer to the question whether the Tribunal could have independently arrived at the same final assessment, lacks any relevant in this context."

³⁸⁴ Cf. Professor Snijders' Expert Opinion, §18(d) and §44 (**Exhibit RF-D9**).

³⁸⁵ Cf. Professor Snijders' Expert Opinion, §18(d) and §44 (**Exhibit RF-D9**): "It should also be considered here that by its very nature the setting-aside remedy of Articles 1064 et seq. DCCP does not carry a devolutive effect [i.e. technical Dutch procedural term]. To paraphrase this in less formal terms: use of this legal remedy does not, in principle, puts the entire case before the domestic court. Moreover, the positive aspects of the devolutive effect certainly do not apply (...)"

³⁸⁶ Cf. Supreme Court 18 June 1993, ECLI:NL:HR:1993:ZC1003, NJ 1994, 449 (*Van der Lely et al./VDH*). See SoR, §§ 350-354, for more details on this. See also the example used by Professor Snijders in his Expert Opinion, (**Exhibit RF-D9**) §50, where (in setting-aside proceedings), having found valid the complaint that the tribunal had applied an incorrect legal standard for its decision (Article 1065(1)(c) in conjunction with Article 1054 DCCP), the domestic court cannot uphold the arbitral award, if needed by amending the reasoning, on the basis of the argument that applying the correct standard for the decision would have yielded the same outcome.

Article 1064(5) DCCP.³⁸⁷ For that reason too, the new grounds for jurisdiction first raised by HVY after the proceedings in the first instance should be disregarded (see also § 268 below).

266. Professor Snijders concludes in his expert opinion:

"66. Only a decision by the tribunal on the basis of which it assumed jurisdiction to decide the case, including the ground given for that decision, can be challenged by reason that no valid arbitration agreement is in place within the meaning of Article 1065(1)(a) DCCP. In part in light of Article 1052(4) and (5) and Article 1064(5) DCCP, the setting-aside proceedings do not allow for an opinion on the question of whether the tribunal could have assumed jurisdiction based on another ground that the tribunal rejected or that was not put forward before the tribunal (and that was therefore not addressed in the arbitration)."³⁸⁸

267. It follows from the above that the District Court rightfully³⁸⁹ ruled that the legal system of setting aside proceedings means that HVY cannot direct any grounds for setting aside against a ruling on jurisdiction that is unfavourable to them:

"5.25 (...) The Tribunal did not follow the reasoning of the defendants and therefore did not base its competence on the absence of such a declaration [within the meaning of Article 45(2) ECT]. In accordance with the legal system of reversal proceedings, from which it follows that the grounds for reversal are stated in the writ and which has determined that a ground for reversal can only be directed against a positive arbitral decision on jurisdiction (Section 1064 subsection 5 and Section 1065 subsection 1 preamble and under a DCCP), there appears to be no room in these proceedings to form an opinion on the question whether or not the Tribunal could have assumed its jurisdiction based on another argument it rejected." [text between brackets added]

(b)(iii) The setting aside proceedings offer no room for new arguments that could have already been raised in the arbitration proceedings

268. In the Arbitrations, both parties extensively addressed the jurisdiction of the Tribunal. Apparently, HVY have since come up with additional arguments and have set those out

³⁸⁷ The Russian Federation disputes the assertions to the contrary in SoA, §§ 643.

³⁸⁸ See Professor Snijders' Expert Opinion § 66, (**Exhibit RF-D9**).

³⁸⁹ See also SoR, §§ 188-189. See also Professor Snijders' Expert Opinion, §45 (**Exhibit RF-D9**): "In light of the foregoing, therefore, it may be concluded that par. 5.25 does in fact reflect a correct interpretation of the law" and §67: "The District Court's findings at 5.25 as quoted in §2 seem entirely correct to me (in conjunction with the District Court's findings at 5.24, also quoted there)."

these for the very first further in their Statement of Appeal. These arguments and grounds cannot be dealt with.

269. First, as discussed above, only a positive decision on jurisdiction is subject to review in setting-aside proceedings (see §§ 257-267 above). In itself, this already means that any new arguments that did not serve as the basis for a "positive" ruling on jurisdiction cannot be addressed. On that ground alone the new arguments that HVY have only raised in these setting aside proceedings ought to be disregarded.
270. Second, and in the alternative: it is incompatible with the principles of due (arbitration) process for a claimant "to keep his powder dry" and to introduce arguments for the first time in setting-aside proceedings. The defendant in arbitration proceedings must submit the reliance on the lack of a valid arbitration agreement before all other defences in the arbitration proceedings. If the defendant fails to do so, he will forfeit such right. This follows from Article 1065(2) DCCP in conjunction with Article 1052(2) DCCP:

“The ground referred to under (a) of the first paragraph cannot lead to setting aside in the case described in Article 1052, second paragraph.”

“A party appearing in arbitration proceedings must submit a reliance on the arbitral tribunal’s lack of jurisdiction, on the ground that a valid arbitration agreement is missing, before all other defences, failing which that party forfeits its right to rely on that lack of jurisdiction later in the arbitration proceedings or before the ordinary court, unless it does so on the ground that the dispute is not open to arbitration proceedings under Article 1020, third paragraph.”

271. In Supreme Court 27 March 2009, *NJ 2010/170 (Smit Bloembollen/Ruwa Bulbs)*, the Supreme Court explained that the rationale of Articles 1052(2) DCCP and 1065 (2) DCCP is to prevent that unnecessary procedural acts are performed:

“3.4.1. (...) However, Article 1052(2) provides that a party appearing in arbitration proceedings must submit a reliance on the arbitral tribunal’s lack of jurisdiction, on the ground that a valid arbitration agreement is missing, before all other defences, failing which that party forfeits its right to rely on that lack of jurisdiction later in the arbitration proceedings or before the ordinary court. By extension, Article 1065(2) provides that the ground for setting aside under (1)(a) (the lack of a valid arbitration agreement) cannot result in the setting aside of the arbitral award in the case described in Article 1052(2):

This combination of provisions serves to effect that, if a party wishes to contest the arbitral tribunal’s jurisdiction on account of the lack of a valid arbitration agreement, the arbitral tribunal can decide on its jurisdiction at an

early stage in the proceedings to prevent the performance of unnecessary procedural acts as much as possible should a reliance on the lack of a valid arbitration agreement at a later stage (during the arbitration proceedings or before the ordinary court) result in the ruling that the arbitral tribunal has no jurisdiction.” (emphasis added)

272. The Supreme Court then addressed, more specifically, the question of the extent to which a party is permitted to support the reliance on the lack of a valid arbitration agreement in setting aside proceedings with new factual or legal positions. All this will have to be assessed on a case by case basis in light of the relevant statutory arrangement and the requirements of due process of law. Other relevant factors can be the extent to which the new positions align with the positions adopted earlier on in the arbitration proceedings, the reason why the new positions were not advanced sooner, and whether the party in question was supported by a lawyer in the arbitration proceedings:

“3.4.2. In light of this purport, it must be assessed whether and to what extent a party that relied on the lack of a valid arbitration agreement before all other defences in the arbitration proceedings is permitted to support the reliance thereon with new factual or legal positions during the further course of the arbitration proceedings or setting aside proceedings. Given the mutual interests in dispute, it cannot be accepted as a general rule that this is never allowed. For instance, it is conceivable that a party which relied on the lack of a valid arbitration agreement before all other defences saw no reason to support its reliance on this ground with new factual or legal positions until after the other party advanced a defence against it (later during the arbitration proceedings or before the ordinary court). On the other hand, it also cannot be accepted as a general rule that there are no limits on advancing entirely new factual or legal positions in support of a timely raised ground at a later date, because this could undermine the statutory arrangement too gravely. Consequently, whether a new factual or legal position violates the purport of the statutory arrangement, given also the requirements of due process of law, will have to be assessed in each concrete case. Other relevant factors can be the extent to which the new positions align with the positions adopted earlier on in the arbitration proceedings, the reason why the new positions were not advanced sooner, and whether the party in question was supported by a lawyer in the arbitration proceedings.” (emphasis added)

273. The rationale of the statutory arrangement and the case law of the Supreme Court is to prevent unnecessary procedural acts. This applies to the defendant in the arbitration proceedings and likewise to the claimant.³⁹⁰ The whole rationale of the statutory

³⁹⁰ See also Professor Snijders' Expert Opinion, §§ 58-59 (**Exhibit RF-D9**): "By reason of the same standards of effectiveness and finality, it is therefore impossible for new jurisdiction grounds or other facts to be put forward in the setting-aside proceedings that could have been presented in the arbitration proceedings,

arrangement would be eroded should the claimant in the arbitration proceedings be allowed to “save” its arguments regarding the existence of a valid arbitration agreement until setting aside proceedings or the appeal thereto.

274. The parties must present their positions as well as possible and, where appropriate, object to any course of affairs they believe to be incorrect as soon as possible. If they fail to do so, they forfeit their right to raise such issues in setting aside proceedings (estoppel). This basic premise – which was generally accepted even in the past³⁹¹ – is laid down in the new arbitration law in Article 1048a DCCP.³⁹²

“A party appearing in the proceedings will object to the arbitral tribunal without unreasonable delay, sending a copy of that objection to the other party, as soon as it is aware or should reasonably be aware of any acts or omissions in violation of any provisions in the second section of this title, the arbitration agreement, or an order, decision or measure of the arbitral tribunal. If a party fails to do so, it forfeits the right to rely on such acts or omissions at a later date during the arbitration proceedings or before the ordinary court.”

275. In his Expert Opinion, Professor Snijders concludes – inter alia on the basis of Article 1048a DCCP (new) and the case *Smit Bloembollen v. Ruwa Bulbs* – that it is contrary to the standards of due arbitration process and due process if an alternative ground for jurisdiction is put forward for the first time in setting-aside proceedings:

"65. All things considered, in my view, it would be incompatible with the standards of due arbitration process, in conjunction with the standards of due process in cases before the domestic courts, if the domestic court were to nevertheless review such an alternative ground regarding the tribunal's jurisdiction."³⁹³

276. During the Arbitrations, both HVY and the Russian Federation expressed their views on the interpretation of Article 45 ECT multiple times. The procedural documents and expert

but were not. (...) It would then be inappropriate for the respondent to be permitted to successfully put forward such new grounds in the setting-aside proceedings."

³⁹¹ See also E. Meerdink and R. van Tricht, "Modernisering van het arbitraal geding" [Modernisation of arbitration proceedings], *Tijdschrift voor Arbitrage* 2013/32: "*The new provision lays down what had already been customary in arbitration practice for years and years.*"

³⁹² See also Professor Snijders' Expert Opinion, §§ 60-64 (**Exhibit RF-D9**), and specifically § 62: "*Essentially, however, Article 1048a DCCP serves to codify the existing case law and common knowledge in the doctrine regarding objections that could, within reason, already have been put forward in the arbitration proceedings but were not, only to then be put forward in subsequent proceedings, specifically setting-aside proceedings, before a domestic court.*"

³⁹³ Professor Snijders' Expert Opinion, §65 (**Exhibit RF-D9**).

opinions submitted by them in that context counted many hundreds of pages. Article 45 ECT was then discussed extensively at the ten-day hearing that pertained exclusively to the Tribunal’s jurisdiction. The primary – if not only – topic for seven of the ten hearing days was the question whether the Russian Federation had consented to arbitration by virtue of Article 45 ECT.³⁹⁴ During the Arbitrations, HVY were assisted by a team of top lawyers. These lawyers charged approximately USD 10,000,000 for their services during the jurisdiction phase alone – which took over four years.³⁹⁵ In addition, they were assisted by dozens of experts in the fields of international and Russian law. Against this background and in light of the relevant condition outlined by the Supreme Court in *Smit Bloembollen/Ruwa Bulbs*, it is unacceptable that HVY bring up entirely new arguments in these setting aside proceedings (notably only in the appellate stage). Moreover because these arguments (i) do not line up with the positions adopted earlier and (ii) could and should have been discussed in the period of 2005-2009.

277. As a result of the foregoing, HVY's new jurisdiction arguments cannot be considered. This affects HVY's arguments based on a novel interpretation of the words "*not inconsistent*" in Article 45(1) ECT (see §§ 365 et. seq.) as well as HVY's new jurisdiction arguments based on the powers granted to President Yeltsin under the 1993 Constitution (see § 387 et. seq. below).

(b)(iv) *Conclusion*

278. Annulment proceedings do not offer the parties a full fledged opportunity to present previously rejected arguments or newly devised arguments. Large parts of the Statement of Appeal should be disregarded for that reason alone.

	Different categories of jurisdiction grounds that are put forward in the setting aside proceedings		
	Category A Jurisdiction grounds explicitly dismissed by an arbitral tribunal	Category B Jurisdiction grounds on the basis of which an arbitral tribunal "positively" assumed	Category C New arguments for jurisdiction of an arbitral tribunal that were not put forward by the claimant in the arbitration

³⁹⁴ This concerns the following hearing days: 17, 18, 19, 20, 26, 28 November 2008 and 1 December 2008. A word for word report of this hearing is digitally available.

³⁹⁵ See Final Awards, marginal 1856.

UNOFFICIAL TRANSLATION

This text is an unofficial translation of the Dutch original. In case of any discrepancies, the Dutch original shall prevail.

		jurisdiction	
Decision Tribunal	The Tribunal dismissed HVY's reliance on Art. 45(2) ECT and estoppel as possible jurisdiction grounds (see in particular §§ 280-283 and 305-308 below)	The Tribunal assumed jurisdiction on the basis of Art. 26 ECT in conjunction with Art. 45(1) ECT	Of course, the Tribunal did not render a decision on jurisdiction grounds the claimant did not rely on in the arbitration proceedings (see for example §§ 371-375 and 390-396 below)
Judgment District Court	"[T]ere [is] no discretion" for the court to reassess jurisdiction grounds put forward by the claimant but rejected in the arbitration; the Court therefore refuted HVY's argument on Art. 45(2) ECT only superfluously	The District Court has reviewed the positive jurisdiction decision of the Tribunal, found that it was incorrect and therefore set aside the Yukos Awards (Art. 1065(1)(a) DCCP)	The District Court reviewed " <i>only (...) a positive arbitral ruling on jurisdiction</i> "; a court hearing setting aside proceedings cannot substitute the jurisdiction grounds assumed by the Tribunal by an alternative jurisdiction ground
Position HVY	The jurisdiction grounds rejected by the Tribunal must be reviewed de novo by the court hearing setting aside proceedings (grounds for appeal 4.2, 2.3, 3 and 6)	HVY recognise that the District Court could review the correctness of the Tribunal's ruling on jurisdiction, but contest the rectitude of the District Court's finding	Entirely new jurisdiction grounds can be reviewed in setting aside proceedings (grounds for appeal 4.2, 2.3, 3 and 6)
Position Russian Federation	A jurisdiction ground - either correctly or incorrectly - rejected by the Tribunal can no longer be successfully brought before the civil court.	The District Court correctly held that the District Court lacked jurisdiction pursuant to Art. 26 and 45(1) ECT; such on the basis of its interpretation of Article 45(1) ECT and also on the finding that arbitration of e.g. tax disputes is contrary	The civil court may only review the Tribunal's positive decision on jurisdiction and therefore may not replace it with a different ground; as such, invoking a new jurisdiction ground is contrary to the due process of law that applies in the

UNOFFICIAL TRANSLATION

This text is an unofficial translation of the Dutch original. In case of any discrepancies, the Dutch original shall prevail.

		to Russian law	arbitration (cf. Article 1048a DCCP (new))
--	--	----------------	--

279. To enable this Court of Appeal to, like the District Court, assess and reject HVY’s positions on substantive grounds as well, the Russian Federation will – in essence entirely superfluously– briefly indicate below why both the previously rejected arguments and the new arguments also fail on substantive grounds.

(c) *The District Court and the Tribunal correctly ruled that a reliance on Article 45(1) ECT does not require a prior declaration pursuant to Article 45(2) ECT*

The Russian Federation refers to:		
<u>Arbitrations:</u>		
HEL Interim Award	Chapter VII.A.3	marginal nos. 270-289
Final Awards		
<u>Setting aside proceedings:</u>		
Writ	Chapter IV.C.b	§§ 133-186
SoD	Part II, Chapter 2.1.4	§§ 267-313
SoR	Chapter III.C.e	§§ 192-219
SoRej	Chapter 2.2.4	§§ 126-145
RF Pleading Notes	Chapter III.3	§ 19
HVY Pleading Notes	Chapter 1.2.3	§§ 64-71
SoA	Part I, Chapter 4.3	§§ 241-245

Primary exhibits:	
<u>Arbitrations:</u>	
R-352	Joint Statement by the EC, the Council and the Member States on the interpretation of Article 45 ECT
C-924	Report Charter Conference
<u>Setting aside proceedings:</u>	
RF-249-RF-272	<i>Travaux préparatoires</i> demonstrating that a prior declaration is not required
RF-230, RF-232, RF-252, RF-253 and RF-273,	Legal literature demonstrating a prior declaration is not required

Essence of the reasoning

A reliance on Article 45(1) ECT does not require a prior declaration pursuant to Article 45(2) ECT.

- The District Court rightly ruled that there was no requirement to make a

declaration as referred to in Article 45(2) ECT before being allowed to rely on Article 45(1) ECT (see subsection (c)(ii)).

- The correctness of the District Court’s interpretation is confirmed by the clear text of Article 45 ECT, the *travaux préparatoires*, the Joint EC Statement and the legal interpretations generally accepted in the literature (see subsection (c)(ii)).
- The District Court correctly ruled that the text of Article 45 ECT may not be deviated from on the basis of views on transparency and reciprocity (see subsection (c)(iii)).

(c)(i) HVY’s position and the Tribunal’s rejection thereof (ground 5.25)

280. HVY argued during the Arbitrations, and they still do to this day³⁹⁶, that a signatory had to make a prior declaration in order to rely on the Limitation Clause. HVY assert that the Russian Federation did not make a declaration and is therefore obliged to apply the entire Treaty provisionally.³⁹⁷ They base this position on the provisions of Article 45(1) and (2) ECT:

“1. Each signatory agrees to apply this Treaty provisionally pending its entry into force for such signatory in accordance with Article 44, to the extent that such provisional application is not inconsistent with its constitution, laws or regulations.

2.a. Notwithstanding paragraph (1) any signatory may, when signing, deliver to the Depository a declaration that it is not able to accept provisional application. The obligation contained in paragraph (1) shall not apply to a signatory making such a declaration. (...)”

281. The Tribunal rejected HVY’s position. The Tribunal ruled that this required little effort. It ruled that nothing in the wording of Article 45 ECT indicates that a declaration must be made before a reliance on Article 45(1) ECT can be made:

“After having considered the totality of the evidence and reviewed the Parties’ submissions, the Tribunal has little difficulty in concluding that Respondent’s thesis and interpretation of Articles 45(1) and 45(2) are to be preferred over those of Claimant. (...)”

³⁹⁶ See SoA, §§ 241-279.

³⁹⁷ See also SoA, §§ 246, 279.

Nothing in the language of Article 45 suggests that the Limitation Clause in Article 45(1) is dependent on the mandatory making of a declaration under Article 45(2).³⁹⁸

282. In these setting aside proceedings, HVY have opposed the unfavourable ruling of the Tribunal. The District Court rejected HVY's arguments and based its ruling on two independently supported grounds.
283. The first ground is that the legal mechanism of setting aside proceedings requires that HVY cannot direct any grounds for setting aside against a ruling on jurisdiction that is unfavourable to them (see §§ 257-267 above). This opinion is correct. In other words, HVY's complaints can and should remain undiscussed in these setting aside proceedings.
284. The second independent ground is that the Russian Federation was not obliged to make a prior declaration on the basis of Article 45(2) ECT. This opinion is further discussed below.

(c)(ii) The District Court rightfully rejected HVY's position that a prior declaration under Article 45(2) ECT was required (grounds 5.27-5.30)

(c)(ii)(i) The ordinary wording of Article 45(2) ECT:

285. The District Court (despite not strictly being required to do so) also rejected the interpretation of Articles 45(1) and (2) ECT proposed by HVY. To that end, entirely in line with Articles 31 and 32 VCLT, the District Court considered the ordinary meaning of the wording of this treaty provision. The District Court ruled that nothing in the text indicates that Article 45(2) ECT is intended to provide the procedural mechanics to apply Article 45(1) ECT. On the contrary, the District Court found that the words “[n]otwithstanding” and “may” in fact show that Article 45(1) ECT and Article 45(2) ECT each provide for a separate specific regime.³⁹⁹
286. The District Court held that Article 45(1) ECT provides for a specific regime that requires a limited provisional application “to the extent that such provisional application is not

³⁹⁸ HEL Interim Award, marginal 262.

³⁹⁹ That judgment is incorrect. See Professor Pellet's 2017 Expert Opinion (**Exhibit RF-D3**), §§ 47-55.

inconsistent with its constitution, laws or regulations.” The text of Article 45(1) ECT does not require a prior declaration.⁴⁰⁰ The District Court phrased its ruling as follows:

“5.27. In light of their ordinary meaning, the wording of paragraphs 1 and 2 of Article 45 ECT – read in isolation and together – do not indicate that the Limitation Clause of paragraph 1 depends on the submission of a declaration under paragraph 2. Although the first paragraph contains an arrangement for provisional application, the same holds for the second paragraph. Nothing in the texts of these paragraphs indicates that paragraph 2 is intended as a procedure rule for the specification of the arrangement in paragraph 1. Article 45 paragraph 2 describes a specific regime that enables a Signatory to completely renounce provisional application, also if under paragraph 1 there is no impediment for provisional application, and therefore there is no incompatibility with national law. Furthermore, the word ‘[n]otwithstanding’ used in Article 45 paragraph 2, which is used at the beginning of the second paragraph and which indicates a deviation from, and not continuation of, the first paragraph, and the word “may”, which refers to a possibility and not to a prescribed mechanism in conjunction with paragraph 1, indicate that Article 45 paragraph 2 does not contain a procedural rule to specify Article 45 paragraph 1. The ordinary meaning of the components of Article 45 mentioned here therefore leads to an explanation in which the first paragraph does not require a prior declaration.”

287. The District Court also addressed the context of Article 45 ECT extensively. The District Court explained that this context in no way implies the forced acceptance of an obligation that is not evident from the text of the Treaty. The District Court concludes that there was no obligation to make a declaration as referred to in Article 45(2) ECT before being allowed to rely on Article 45(1) ECT.⁴⁰¹

(c)(ii)(ii) *The travaux préparatoires of Article 45(2) ECT*

288. The opinion of the District Court corresponds with the *travaux préparatoires*.⁴⁰² The text of Article 45(1) ECT⁴⁰³ formed as a completely independent arrangement in an early stage of the negotiations. For instance, Article 41 of the draft text of 31 October 1991 read as follows:

⁴⁰⁰ The District Court rightfully ruled that Article 45(2) ECT does not change this. The Russian Federation disputes the statements in SoA §§ 249-253. The assertion that, supposedly, the mechanisms in Article 45(2) and (3) ECT are or would become completely meaningless is incorrect and incomprehensible. Article 45(2) and (3) ECT most certainly have meaning and several States have made declarations based on those paragraphs.

⁴⁰¹ See Judgment, grounds 5.29-5.30.

⁴⁰² The Russian Federation disputes the statements in SoA §§ 258-267.

⁴⁰³ The numbering changed multiple times. For a long time, the arrangement on provisional application was included in Article 50 of the draft text.

“The signatories agree to apply this Agreement provisionally following signature, to the extent that such provisional application is not inconsistent with their national laws pending its entry into force in accordance with Article 40 above.”⁴⁰⁴

289. More than two years later, in 1994, a paragraph was added to this Article to further accommodate States that did not wish to apply the Treaty provisionally at all.⁴⁰⁵ The documents drawn up at the time clearly show that Article 45(2) ECT also provides for an independent arrangement (see §§ 87, 93 et seq. above).
290. Ms Lise Weis, who was closely involved in the negotiations as a legal adviser on behalf of the ECT Secretariat, stated that Article 45 ECT provided for several “*options*”.⁴⁰⁶ Similarly, Mr Charles Rutten made it clear during the plenary negotiations that Article 45 ECT provides for several separate regimes that offered a solution for different problems (“*different possibilities*”):

Chairman Rutten: “(...) I think that the text in Room Document 15 based on the Japanese proposal which is, I think, a very ingenious one that covers indeed all the problems that have arisen during the discussions on this matter. And if I may give a personal preference I think the most elegant way to do it would indeed be to include the article in the Treaty itself, covering the different possibilities rather than in a document which would have to a certain extent a different status, even if it would also be in itself legally binding. (...)” (emphasis added)⁴⁰⁷

291. In this context, reference can also be made to a fax message dated 9 November 1994 from Mr Clive Jones, the Secretary-General of the Energy Charter Conference Secretariat at the time. Jones was closely involved in the negotiations and the formation of the ECT.⁴⁰⁸ According to Mr Jones, a declaration within the meaning of Article 45(2) ECT is not required, unless a State is unwilling to apply the Treaty provisionally for political reasons.

⁴⁰⁴ Note: the different draft versions of the Treaty are publicly available now at <http://www.energycharter.org/what-we-do/dispute-settlement/access-to-travaux-preparatoires/energy-charter-treaty-drafts/>.

⁴⁰⁵ The draft text of 20 December 1993 did not yet include a draft of the current Article 45(2) ECT. But, such an arrangement can be found in the draft text of 17 March 1994.

⁴⁰⁶ See the Fax from Lise Weis to Craig Bamberger dated 10 November 1994, Re: provisional application, (**Exhibit RF-249**), which mentions two different “options”, “option 1” and “option 2”.

⁴⁰⁷ See, for instance, Plenary Session dated 8 March 1994, C-924, pp. 14-15.

⁴⁰⁸ Clive Jones was the Secretary-General of the Energy Charter Conference Secretariat in the period of 1991-1995.

His fax shows that a State can rely on Article 45(1) ECT without requiring a declaration under Article 45(2) ECT.⁴⁰⁹

292. The (binding) Joint EC Statement already cited is also relevant (see § 114 above). The EC and its member states at the time (including the Netherlands⁴¹⁰ and Italy⁴¹¹) explicitly indicated that a reliance on Article 45(1) ECT requires no prior declaration:

“Article 45(1) of the European Energy Charter Treaty should be interpreted as defining the conditions and limits for the provisional application of the ECT by the Signatories:

(...) (b) on the basis of this interpretation of Article 45(1) to the ECT, a Signatory is not bound to enter a declaration of non-application, as is provided for in Article 45(2) ECT (...)” (emphasis added)⁴¹²

293. The Russian Federation consistently made it clear that the scope of the provisional application was limited under Article 45(1) ECT, despite the fact that it made no declaration (see § 124 above).⁴¹³ Similarly, a memorandum from the Finnish Ministry of

⁴⁰⁹ Fax from Clive Jones to Lise Weis and Craig Bamberger, among others, dated 9 November 1994, Re: draft provisional application (**Exhibit RF-272**). Original English text: "*Provisional Application*

Article 45(1) states that provisional application is subject to a country's constitution, laws or regulations. A declaration under 45(2)(a) would therefore only be necessary if the reason for not accepting provisional application was political or a matter of government policy.

If, for instance, a country could not legally accept provisional application unless it first had the approval of Parliament, that would presumably be covered by the constitutional exception in 45(1) and no declaration would be necessary.

Also, it may be the case in a number of countries that new obligations created by the Treaty, even if there were no conflicting laws, could not be accepted until new national laws had been passed to give effect to those obligations. Again, this would seem to be covered by the constitutional exception in 45(1) and no declaration would be necessary (...)" (emphasis added)

⁴¹⁰ The Russian Federation disputes HVY's statements in SoA §§ 271-272. These assertions are not supported by the documents. On the contrary, HVY do not discuss any relevant source. See §§ 106-112 above.

⁴¹¹ The Russian Federation disputes the statements in SoA §§ 268-270. For more details in this context, see SoR, §§ 82-83 and 205.

⁴¹² "A" Item Note from the Permanent Representatives Committee to the Council of the European Union, Doc. 12165/94, Annex 1 (December 14, 1994), 3 (R-352).

⁴¹³ The Russian Federation disputes SoA, §§ 274-276. The conclusions drawn by HVY further to Professor Yershov's opinion are incomprehensible and not supported by the text. The same goes for the conclusions they draw from the irrelevant fact that the Russian Federation indicated many years later that it would not provisionally apply further protocols or amendments to the Treaty at all. The Russian Federation disputes the statements in SoA §§ 268-270. For more details in this context, see SoR, §§ 82-83 and 205.

⁴¹³ "A" Item Note from the Permanent Representatives Committee to the Council of the European Union, Doc. 12165/94, Annex 1 (December 14, 1994), 3 (R-352): "*Article 45(1) of the European Energy Charter Treaty should be interpreted as defining the conditions and limits for the provisional application of the*

Foreign Affairs dated November 1994⁴¹⁴ shows that the Finnish government believed that no “*separate notification*” was required to rely on Article 45(1) ECT.⁴¹⁵ Although it had made no declaration, the Dutch government also trusted that the provisional application would apply only “*to the extent that it is not inconsistent with the constitution, laws or regulations.*”⁴¹⁶

(c)(ii)(iii) *Literature on the interpretation of Article 45(2) ECT*

294. The interpretation proposed by HVY met much criticism in legal literature.⁴¹⁷ Messrs Thomas Roe and Matthew Happold considered this interpretation “*not well founded*”.⁴¹⁸ Professor Gazzini considered the Tribunal’s rejection of this interpretation “*quite convincing*”.⁴¹⁹
295. The conclusion is that the assessment of both the Tribunal and the District Court is correct. Article 45(1) ECT and Article 45(2) ECT provide for two separate regimes. A reliance on Article 45(1) ECT does not require a declaration within the meaning of Article 45(2) ECT. To avoid a needless repetition, the Russian Federation refers to the arguments as explained in §§ 191-219 of the Reply. In addition, the Russian Federation also refers to the statements and expert opinions submitted earlier, particularly:

ECT by the Signatories: (...) (b) on the basis of this interpretation of Article 45(1) to the ECT, a Signatory is not bound to enter a declaration of non-application, as is provided for in Article 45(2) ECT (...) (emphasis added)

⁴¹³ The Russian Federation disputes SoA, §§ 274-276. The conclusions drawn by HVY further to Professor Yershov’s opinion are incomprehensible and not supported by the text. The same goes for the conclusions they draw from the fact the Russian Federation indicated many years later that they would not provisionally apply further protocols or amendments to the Treaty at all.

⁴¹⁴ See Writ, § 160.

⁴¹⁵ Finnish Ministry of Foreign Affairs Memorandum (22 November 1994), 5 (**Exhibit RF-32**).

⁴¹⁶ Explanatory Memorandum, as cited in SoA, § 271.

⁴¹⁷ See, for example, U. Klaus, “The Gate to Arbitration, The Yukos Case and the Provisional Application of the Energy Charter Treaty in the Russian Federation” *Transnational Dispute Management* 2005, Vol 2(3), (**Exhibit RF-252**). Original English text: “*The wording of Art. 45 (2) (a) ECT clearly indicates that opting out is optional, not mandatory.*” See also S. Pritzkow, *Das völkerrechtliche Verhältnis zwischen der EU und Russland im Energiesektor*, Springer, 2011, pp. 60-64 (**Exhibit RF-230**).

⁴¹⁸ Thomas Roe and Matthew Happold, *Settlement of Investment Disputes under the Energy Charter Treaty*, Cambridge 2011, p. 74, Annex H-6 (**Exhibit RF-253**): “*This argument is not well founded.*”

⁴¹⁹ T. Gazzini, “Yukos Universal Limited (Isle of Man) v. The Russian Federation, Provisional Application of the ECT in the Yukos Case” *ICSID Review*, Vol. 30, No. 2 (2015) pp. 293-302, p. 295 (**Exhibit RF-232**). Original English text: “*The argument developed by the Tribunal is quite convincing. The Tribunal could nevertheless have better emphasized the importance of the word ‘notwithstanding’.*” See also T. Gazzini, “Provisional Application of the Energy Charter Treaty: A Short Analysis of Article 45”, *Transnational Dispute Management* 2010 Volume 7(1), pp. 1-17, pp. 10-11 (**Exhibit RF-273**).

- (a) The statement by Mr Fremantle, former chairman of the working group that drew up the first draft of the ECT.⁴²⁰
 - (b) Professor Nolte's expert opinion dated 31 October 2006.⁴²¹
 - (c) Professor Hafner's expert opinion dated 30 December 2006.⁴²²
 - (d) Professor Koskenniemi's expert opinion dated 27 October 2006.⁴²³
 - (e) Professor Pellet's expert opinion dated 13 December 2006.⁴²⁴
- (c)(iii) *The District Court correctly ruled that one cannot derogate from the text of Article 45 ECT because this would be more desirable from the standpoint of transparency or reciprocity point of view (ground 5.28)*
- (c)(iii)(i) *The District Court's opinion*

296. HVY expressed criticism on the text of Article 45 ECT. They believe that it is better from a transparency and reciprocity point of view if signatories that have not made a declaration are obliged to apply the entire Treaty provisionally. Moreover, they believe that such considerations should also hold weight in the interpretation of Article 45 ECT.⁴²⁵ The Tribunal explicitly and definitively rejected this view:

“(…) However, the fact remains that, at the end of the day, when the negotiations were concluded and the ECT signed by the Russian Federation, Article 45(1) did not expressly require any form of declaration or notification in order to allow a signatory to invoke the Limitation Clause. Transparency did not trump the clear inconsistency provision of Article 45(1). Applying the rules of interpretation of Articles 31 and 32 of the VCLT, which were quoted earlier, the Tribunal cannot read into Article 45(1) of the ECT a notification requirement which the text does not disclose and which no recognized legal principle dictates.”⁴²⁶

⁴²⁰ Fremantle's Expert Opinion (**Exhibit RF-03.1.C-1.3.3**), §§ 54 et seq.

⁴²¹ Professor Nolte's 2006 Expert Opinion (**Exhibit RF-03.1.C-1.3.7**), §§ 8, 14-20.

⁴²² Hafner's Expert Opinion (**Exhibit RF-03.1.C-1.3.11**), §§ 34-50.

⁴²³ Koskenniemi's Expert Opinion (**Exhibit RF-03.C.1-1.3.4**), §§ 51-55.

⁴²⁴ Professor Pellet's 2006 Expert Opinion (**Exhibit RF-03.1.C-1.3.9**), § 29.

⁴²⁵ See SoD, §§ II.280-II.291.

⁴²⁶ HEL Interim Award, marginal 283.

297. The District Court also rejected the reliance on the general principles of reciprocity and transparency. The District Court believes that such considerations cannot require the forced acceptance of an obligation, not included in the Treaty text, to submit a declaration:

“5.28. (...) Although during the negotiations the various states stressed the importance of transparency regarding an invocation of the Limitation Clause, and the Secretariat of the ECT encouraged the Signatories to be transparent about the provisional application (see the Interim Awards under 282), these circumstances are not compelling enough to deduce an implicit obligation to submit a prior declaration. If the drafters of the Treaty had also wanted to make invocation of the Limitation Clause due to incompatibility with national law conditional on a prior declaration, they obviously would have expressly included this, like they also did in paragraph 2. They did not do this. The argument of the defendants regarding the object and purpose of the ECT can be largely reduced to the already mentioned desirability of transparency and therefore does not lead to a different opinion. The principle of reciprocity mentioned by the defendant in that respect, which they believe will be impaired if the Tribunal’s explanation were to be followed, also does not succeed. In connection with this aspect, the Russian Federation has correctly remarked that Article 45 paragraph 1 ECT does not contain indications for a requirement of absolute reciprocity. The fact that Article 45 paragraph 2 under b contains the principle of reciprocity for the cases described in paragraph 2 under a does not automatically lead to the opinion that Article 45 paragraph 1 contains an obligation to submit a prior declaration.”

298. HVY oppose this ruling of the District Court. To that end, they rely on the arguments they raised previously in the first instance, i.e., own subjective views regarding reciprocity and transparency.⁴²⁷

(c)(iii)(ii) *Reciprocity*

299. At the time of the negotiations on Article 45(1) ECT, Japan rightfully indicated that the text of Article 45(1) ECT⁴²⁸ means that “*how much of this Treaty*” will be provisionally applied will differ from country to country (see § 120 above). Further examination of the national laws and regulations is required to map these differences. These differences mean that there will be no absolute reciprocity between all signatories.⁴²⁹ The signatories

⁴²⁷ See SoD, §§ II.280-II.291, and SoA, §§ 244, 248-269, 308-309, 320, 367-368 and 370-374. The Russian Federation refers to the SoR, §§ 208-214, for a refutation. See also Professor Pellet’s 2017 Expert Opinion (**Exhibit RF-D3**), §§ 61-64.

⁴²⁸ Then: article 50 of the draft text.

⁴²⁹ It should be noted that, to meet specific objections and problems, signatories have deliberately and more than once accepted treaty provisions resulting in unequal rights and obligations. Article 32 ECT is a clear example of this.

nevertheless explicitly agreed to Article 45(1) ECT.⁴³⁰ They did not include any further requirements or conditions to guarantee – absolute – reciprocity. The fact that HVY find this undesirable does not change this. In this regard, Prof. Pellet states:

First of all, States are free to conclude an agreement which can be considered unfair by an observer without making this agreement null and void. Furthermore, what is described by Klabbers [HVY's expert] is unfair only if one follows the interpretation he makes of it, which is eminently subjective (...)⁴³¹

(c)(iii)(iii) *Transparency*

300. Article 20 ECT includes a specific arrangement meant to promote transparency. This Article provides, among other things, that legislation be disclosed. The Russian Federation has published its legislation.⁴³²
301. Article 45(1) ECT itself does not contain any provisions on transparency. No prior declaration is required if a State – such as the Netherlands or the Russian Federation – provisionally applies part of the Treaty by virtue of Article 45(1) ECT. As Professor Nolte elaborates in his expert opinion, Article 45(1) ECT does not require States either to clarify in advance which parts of the Treaty they will apply provisionally and which parts they will not apply provisionally.

“It follows that Article 45 (1) ECT does not give other signatory States a right, or a legitimate expectation, that any particular State undertake and submit a survey of its own internal law and transmit the result of this survey to the other signatory States with a view of determining the scope of application, for itself, of the ‘to the extent’ clause in Article 45 (1) ECT.”⁴³³

⁴³⁰ The Russian Federation disputes the statements in SoA §§ 255-257. See more elaborately: SoR, paragraphs 212-214.

⁴³¹ Professor Pellet's 2017 Expert Opinion (**Exhibit RF-D3**), § 64. [English original text]: “*First of all, States are free to conclude an agreement which can be considered unfair by an observer without making this agreement null and void. Furthermore, what is described by Klabbers is unfair only if one follows the interpretation he makes of it, which is eminently subjective (...)*”

⁴³² It should be noted that HVY do not assert (and rightfully so) that the Russian Federation violated its obligations under Article 20 ECT. Various Russian government bodies are making an effort to provide information on Russian laws and regulations. Websites of the Russian Federation have listed and still list the addresses and phone numbers of various bodies that can address questions on investments in the energy sector. In addition, the Russian Federation remarks (based on Article 32 ECT) that it was not even obliged to comply with Article 20(3) ECT, which HVY also acknowledge in SoA, § 311.

⁴³³ Professor Nolte's 2017 Expert Opinion (**Exhibit RF-D2**), § 45.

302. The main purpose of Article 45(1) ECT was to implement the Treaty immediately after signing, where possible, in a way that would satisfy national constitutional limitations (see §§ 52-58 and 87-92 above). Transparency and reciprocity played no meaningful part in the formation of Article 45(1) ECT.⁴³⁴ On 10 November 1994, Ms Lise Weis concisely wrote to Mr Craig Bamberger with regard to Article 45 ECT:

“(…) There certainly is no transparency requirement.”⁴³⁵

303. Attempts to describe which provisions would in any event not be applied provisionally, by any State, were made at the time of the negotiations.⁴³⁶ However, such attempts encountered a great deal of resistance and were therefore abandoned. The general thought was that it was undesirable to make an exhaustive analysis of the provisions that would be applied provisionally. HVY now claim that this would result in major problems for investors.⁴³⁷ The Negotiating States, however, believed that there were “*small uncertainties*” that apparently were not considered an obstacle:

"As a matter of general international law there are certain kinds of treaty provisions (e.g. those on amendment) that probably do not fall within the accepted scope of provisional application. I believe that it would be far better to be silent on the matter and let things be dealt with as they may arise, than to try in advance and in the abstract to identify each jot and tittle of the treaty that would not apply under Article 50. It seems to me that living with the small uncertainties involved would be a small price to pay to avoid the endless hell of trying to agree on what should, and what should not, apply provisionally". (emphasis added)⁴³⁸

304. HVY allege that it would take investors a huge study into Russian law to assess the exact extent of the provisional application.⁴³⁹ In reality, prudent investors will have to investigate the local laws and regulations prior to investing no matter what. Such investors would be able to discover without too much effort that arbitration of tax disputes, execution and

⁴³⁴ The Russian Federation contests SoA, §§ 253-254, and the assertion that the supposed purpose of Article 45(1) ECT is to safeguard transparency and reciprocity. The Russian Federation disputes the statements in SoA §§ 258-267. At most, the documents cited there show that transparency and reciprocity played a part in the formation of Article 45(2) and (3).

⁴³⁵ Fax from Lise Weis to Craig Bamberger dated 10 November 1994, Re: provisional application, (**Exhibit RF-249**).

⁴³⁶ See e.g. (**Exhibit RF-274**), Letter from Craig Bamberger (European Energy Charter) to Lise Weis regarding provisional application dated 18 February 1994. Bamberger suggested to designate at least some treaty provisions that would not be applied provisionally.

⁴³⁷ See, *inter alia*, SoA §§ 309-310 en 371.

⁴³⁸ Fax from Ted Borek to Lise Weis dated 25 February 1994 on provisional application, (**Exhibit RF-275**).

⁴³⁹ See, *inter alia*, SoA §§ 309-310 en 371.

expropriation disputes is not allowed under Russian law, as in many other States (see also §§ 310 et seq. below).

- (d) *HVY's previously rejected reliance on acquiescence and estoppel is untenable*

The Russian Federation refers to:		
Arbitrations:		
-		
Setting aside proceedings:		
Writ		
SoD		
SoR		
SoRej		
RF Pleading Notes		
HVY Pleading Notes		
SoA	Chapter 3.4	§§ 183-227

Primary exhibits:	
Arbitrations:	
Setting aside proceedings:	
RF-266, RF-284-RF-289	Documents showing that the Russian Federation made it sufficiently clear that it merely applied the Treaty provisionally and that public-law disputes are non-arbitrable
RF-D4	Avtonomov's Expert Opinion
RF-D2	Nolte Expert Opinion

Essence of the reasoning

HVY rely in vain on the doctrines of acquiescence and estoppel under international law.

- The reliance on acquiescence and estoppel was irrevocably rejected by the Tribunal before (subsection (d)(i)).
- Moreover, there is no factual basis for estoppel or acquiescence anyway:
 - The Russian Federation consistently indicated that it would apply the ECT provisionally only to the extent that it corresponded with its national laws and regulations (section (d)(ii)(ii)).
 - Investors were able to establish that parts of the Treaty are incompatible with the Russian law applicable at the time (section (d)(ii)(iii)).
 - The Russian Federation made it sufficiently clear that public-law disputes are non-arbitrable (section (d)(ii)(iv)).
- HVY's reliance on the IMS/DIO ruling and Article 10:167 DCC fails (section (d)(iii)).

- In any event, HVY's arguments fail to meet the strict legal threshold for a successful reliance on estoppel and acquiescence under international law (section (d)(iv)).

(d)(i) *Introduction*

305. In the third chapter of the Statement of Appeal, HVY assert that the Russian Federation supposedly cannot rely on Article 45(1) ECT. According to HVY, that right has been forfeited.
306. In the Arbitrations, HVY already argued – on the basis of exactly the same documents⁴⁴⁰ – that the Russian Federation should be bound by Article 26 ECT. The Tribunal explicitly rejected this reliance on the documents in question in the Interim Awards. The Tribunal found that the Russian Federation was allowed to rely on Article 45(1) ECT. Briefly put, the Tribunal believed that the requirements for a reliance on estoppel had not been met:

“286. (...) Indeed, Claimant argued that the Russian Federation should be estopped from seeking to rely on the Limitation Clause in Article 45(1) due to its long-standing and unqualified support for the provisional application of the ECT during the negotiations. Respondent replied that the conditions for the existence of a situation of estoppel are not met in this case because, according to the North Sea Continental Shelf Cases, Claimant, to succeed with its estoppel argument, would need to establish more than mere support by the Russian Federation during the negotiations of the Treaty for the provisional application of the ECT.

287. Respondent referred the Tribunal to the following passage from the judgment of the ICJ in the *North Sea Continental Shelf Cases*:

[I]t appears to the Court that only the existence of a situation of estoppel could suffice to lend substance to [the contention that the Federal Republic was bound by the Geneva Convention of 1958 on the Continental Shelf] [. . .],—that is to say if the Federal Republic were now precluded from denying the applicability of the conventional régime, by reason of past conduct, declarations, etc., which not only clearly and consistently evinced acceptance of

⁴⁴⁰ See the documents cited in, for example, the Hulley Counter Memorial on Jurisdiction, §§ 234-240, and Mr Gladyshev's opinion, §§ 117-127. Further to these documents, the Russian Federation indicated that the statements cited do not create any rights, cannot serve as substitute for the ratification of the Treaty and therefore do not block the reliance on Article 45 ECT in any way. In that context, reference is made to the so-called *North Sea Continental Shelf Cases*. See the Russian Federation's position as presented in the Second Memorial on Jurisdiction, §§ 193-211.

that régime, but also had caused Denmark or the Netherlands, in reliance on such conduct, detrimentally to change position or suffer some prejudice. [emphasis added]

288. Applying the standard thus established by the ICJ, the Tribunal concludes that the present case does not satisfy the conditions for the existence of a situation of estoppel. The Tribunal finds that the estoppel argument fails principally because Respondent's support for provisional application of the ECT during the negotiations, even if it could be considered 'consistent,' never 'clearly' excluded the possibility that Respondent was in fact relying on its interpretation of the operation of the Limitation Clause in Article 45(1) which would in any event exclude or limit provisional application of the Treaty."⁴⁴¹

307. HVY do not address the Tribunal's reasoning at all in the third chapter of the Statement of Appeal. That their forfeiture-of-rights argument was explicitly rejected during the Arbitrations is ignored entirely.
308. HVY's renewed reliance on estoppel – which implicitly seems to involve a procedural complaint – can no longer be discussed in these setting aside proceedings, as the court only reviews a positive ruling on jurisdiction by a tribunal. That HVY may have elaborated the legal framework of their previous reliance on estoppel in more detail naturally does not change this.⁴⁴² For that reason alone, the entire third chapter of the Statement of Appeal should be disregarded (see §§ 257 et seq. above).
309. Entirely superfluously, the Russian Federation will nevertheless address HVY's assertions. In this regard, the Russian Federation will explain that there is simply no factual basis for HVY's reliance on acquiescence or estoppel. The Russian Federation consistently indicated that it would apply the ECT provisionally only to the extent that it corresponded with its national laws and regulations. It also consistently stated that a dispute such as this cannot be settled by arbitration. Finally – and even more superfluously – the Russian Federation will explain that HVY's arguments are based on incorrect legal interpretations.

(d)(ii) No factual basis for a reliance on estoppel or acquiescence

(d)(ii)(i) Introduction

⁴⁴¹ HEL Interim Award, paragraphs 286-287.

⁴⁴² To the extent that HVY supposedly believe that the third chapter can be read as a new reliance on specific statements and sub-arguments that were never previously addressed, the argumentation is still inadmissible. After all, that would make it an entirely new argument that HVY could and should have raised back in 2005. Such a new argument can no longer be discussed (see § 277 above).

310. The Russian Federation consistently indicated that it did not ratify the ECT and that it would apply the ECT provisionally only to the extent that it corresponded with its national laws and regulations (see §§ 100 et seq. and §§ 123 et seq. above). It will be explained below that investors could and should have known that the Treaty might never be approved. They could and should have considered this. In addition, it was clear from the start that there was great resistance to the ECT in the Duma. It will then be explained that the Russian Federation more than once confirmed that the Treaty diverges from Russian laws and regulations. The Russian Federation publicly explained that public-law investment disputes must be resolved by the domestic courts. In fact, during the public debate on the legislative proposal in the Duma, it was made explicitly clear that the arbitration clauses in the Treaty would not be effective until after the ECT's approval and entry into force.

(d)(ii)(ii) *Investors had to consider the possibility that there would be no ratification, especially since it was clear from the start that there were significant objections within the Duma to the ECT*

311. It is in no way self-evident that a treaty which is signed will also be approved.⁴⁴³ At the time of the negotiations, the United States made it clear that investors would understand the risks involved if they were to invest in a State that had signed the Treaty, but had not yet approved it:

“United States: (...) Again, it seems to me also that an investor who, an investor must be, must be assumed to have some perception of the risk involved if it invests in a country knowing that that country has signed but not yet ratified the Treaty. There is always the chance that the country won't ratify the Treaty, and I think we can assume that investors, prudent investors, will take that into account in making their investment decision.”⁴⁴⁴

312. Even during the negotiations, it was clear that the Russian Federation had significant substantive objections to parts of the Treaty and the relevant protocols. Contrary to what HVY assert, the Russian Federation was not a big driving force behind the Treaty and did not press for a quick entry into force.⁴⁴⁵ On the contrary, the Russian Federation in fact

⁴⁴³ Ultimately, the ECT was not ratified by the signatories Norway, Australia, Belarus and the Russian Federation.

⁴⁴⁴ See Plenary Session dated 7 March 1994, C-924, p. 13.

⁴⁴⁵ HVY wrongfully assert that the Russian Federation was a big proponent of a quick completion of the negotiations, a powerful system of provisional application and a very quick implementation of the entire Treaty. SoA, §§ 138, 139 and 146-152. Naturally, the Russian Federation attempted to prevent any

delayed the formation because it more than once requested a pause in the negotiations on substantive grounds. This was generally known worldwide. For instance, the Dutch newspaper *Het Financieele Dagblad* published the following headline on 11 April 1992:

“Russia delays energy community

The negotiations on the basic agreement, the legally binding translation of the European Energy Charter launched by Prime Minister Lubbers, are suspended at Russia’s request. As a result, the treaty will most definitely not be signed before the summer holidays (...).⁴⁴⁶

313. During the negotiations, the Russian Federation more than once pointed to fundamental issues on which the negotiating parties disagreed strongly.⁴⁴⁷ The substantive objections of the Russian Federation were of such a fundamental nature that, for a long time, the Russian Federation was seriously considering breaking off the negotiations entirely. In fact, whether a representative of the Russian government would even sign the Treaty was unclear until the day before the scheduled signing. This was known worldwide. Similarly, in Dutch newspapers appeared dozens of articles discussing Russia’s substantive

unnecessary delays. However, that does not change the fact that the Russian Federation considered a thorough substantive review and assessment paramount, which indisputably cost more time than expected. A letter from David Brown (US) to Clive Jones (European Energy Charter) dated 29 April 1992 with the subject Conversation with Andrey Konoplyanik, Russian Deputy Minister of Fuels & Energy for Int'l Affairs (**Exhibit RF-276**) shows that the Duma was already divided on the Basic Agreement and that approval would not just automatically be granted. Original English text: *"I asked Konoplyanik if any in Moscow were antagonistic to the notion of a Basic Agreement. Yes, he replied; they fall into two groups. First, there are the politicians of conservative or Slavophile persuasion, e.g. Genovsky. These tend to see liberal terms for foreign investors as tantamount to a firescale of Russia's national treasure, or neo-colonialism. They object to restrictions on sovereign rights, and regard national treatment as dangerous to home industries. Second, there are Russia's monopolies and quasi-monopolies, like Gazprom. These see the Charter's obligation on governments to promote competition as a dangerous threat, and they are, Konoplyanik stressed, a formidable economic lobby."*

⁴⁴⁶ *Financieele Dagblad*, ‘Rusland vertraagt energiegemeenschap’, 11 April 1992 (**Exhibit RF-277**).

⁴⁴⁷ This is evident from, among other things, the letter from former Russian deputy prime minister Shokhin, cited by HVY; see SoA, § 147 (C-871). Original English text: *"(...) the Russian side feels it necessary to note that the negotiation process is complicated by a number of remaining unsolved fundamental questions (...)"*. In this context, also see the letter from Clive Jones to Charles Rutten dated 11 May 1994 with the subject: Russia Nuclear Trade (**Exhibit RF-278**). Original English text: *"The emerging Russian line on nuclear trade, led by the Trade Ministry, is that they will not sign the ECT unless it represents a move forward on nuclear trade compared to the PCA."* As well as the letter from Clive Jones to Mr Demarty dated 28 May 1993 with the subject: President's meeting with Energy Charter Conference Chairman – 1st June 1003 (**Exhibit RF-279**). Original English text: *"Perhaps the only significant development since my note to you of 10 May has been the rather positive attitude I encountered in my visit to Moscow on 20-21 May (...) Nevertheless, there is no realistic chance of reaching agreement in principle on the outstanding issues at the June Plenary. That meeting will, at best, serve to define the gap between what the Western countries want on Investment and what Russia is prepared to offer. (...)"*

objections, concerning nuclear power among other things.⁴⁴⁸ Ultimately, the Russian Federation did sign the Treaty. Dutch newspaper *De Volkskrant* published the following headline on 19 December 1994:

“Russia agrees to energy pact after all,

After a night of negotiations and to the relief of the ministers of energy of more than forty countries, including Minister Wijers of Economic Affairs, Russia signed the Energy Charter treaty in Lisbon last Saturday. (...).⁴⁴⁹

314. The uncertainty about whether the Russian Federation would ratify the Treaty was generally known precisely because of the significant substantive objections of the Russian Federation during the negotiations. On 25 November 1994, the *Financial Times* reported that the Treaty would not be received with undivided enthusiasm in the Russian Federation itself. The *Financial Times* cited Mr Kalistratov, a prominent member of the Duma who was closely involved in the formation of the Treaty. Kalistratov indicated that there was much resistance to the Treaty within the Federal Parliament.⁴⁵⁰ In more or less equal terms,

⁴⁴⁸ See, for instance, *Het Algemeen Dagblad*, ‘Ook Rusland tekent Energie Handvest’, 19 December 1994 (**Exhibit RF-280**): “*To the very last moment, it was unclear whether the Russian Federation would sign. Some problems had arisen regarding the transfer of dividends to the West, as the central bank in Moscow feared that this would create an escape route for black money of the Russian mafia. Another problem was the trade in nuclear material from Eastern Europe. The Russians do not want to be accused, based on the treaty, of dumping enriched uranium on the European market.*” *Financial Times*, ‘Russia signs up for Charter’, 27 January 1995: “*After a flurry of last minute negotiations, the Russian Federation was among the 41 countries which signed the European Energy Charter Treaty in Lisbon on 17 December, despite reservations that it would not formally sign in Portugal (EEE 38/5). According to EEE’s sister publication EC Energy Monthly, Russian vice-prime minister Oley Davydov finally put pen to paper after winning concessions at a final plenary negotiating session in Lisbon. Signatories included nearly all European states and countries from the former Soviet Union, plus Australia. The US, Canada and Norway, however, were among the nine who did not. While no changes were made to the Treaty text, or the Final Act - an interpretative document detailing the outcome of negotiations in the run-up to Lisbon - the Russian Federation and Norway were allowed to set out their views on key areas of concern in a separate document, which will then be used as a further interpretation of Treaty articles in the case of future dispute. In the run up to the Lisbon signing, the Russians, concerned about the amount of foreign exchange leaving the country via Russian-based companies, won tighter controls on capital transfer payments, with signatories agreeing that countries could restrict transfers by their own investors. At Lisbon, however, Russia made it clear that Russian-based subsidiaries of foreign companies will be treated as Russian, and therefore could be subject to some restrictions on capital transfers.*”

⁴⁴⁹ *De Volkskrant*, ‘Rusland toch akkoord met energie-pact’, 19 December 1994 (**Exhibit RF-281**). The article outlines some of the substantive issues, e.g.: “*(...) Some problems had arisen regarding the transfer of dividends to the West, as the central bank in Moscow feared that this would create an escape route for black money of the Russian mafia.*”

⁴⁵⁰ *Financial Times*, 25 November 1994 (**Exhibit RF-282**): “*Opposition in Duma (...) Kalistratov admitted that if the document, even in its present form, was put for parliament’s ratification now, it would be resisted by conservative factions which constitute a significant part of the Duma. (...)*”

the NRC reported on 16 December 1994 that ratification of the Treaty by the Russian Federation would be difficult because there were objections to the Treaty in the Duma.⁴⁵¹

315. The ECT was offered to the Federal Parliament (the Duma) for ratification. After a thorough substantive debate, it became apparent that there was no clear majority in the Parliament.⁴⁵² The Federal Parliament therefore decided to postpone the ratification of the Treaty until further notice in June 1997. After the matter, the course of affairs was summarized as follows:

"In February 1997, the State Duma held a seminar to study the provisions of the ECT and the Protocol. In July of that same year, the ECT and the Protocol were reviewed by the Russian Audit Chamber, and in June 1997, parliamentary hearings were held on the issues regarding the ratification of the relevant documents, whereby it was recommended to postpone ratification of the ECT and the Protocol until Russia had joined the World Trade Organization (WTO)."⁴⁵³

316. Some years later, after the composition of the Federal Parliament changed, the proposal to ratify the ECT was again discussed substantively. At a hearing on 26 January 2001, it became apparent that the Duma was once again divided and that, in particular, there were many economic objections to the Treaty. Mr Kamarov (Gazprom), for example, garnered applause when he explained in detail (i) that the Russian Federation would gain little from the arrangements on transit (ii) that the Treaty would undermine the existing and well-functioning system which involves drafting long-term contracts and (iii) that according to

⁴⁵¹ NRC *Handelsblad*, 'Russen twijfelen over aangaan vergaande verplichtingen; Ondertekening Energie Handvest', 16 December 1994 (**Exhibit RF-283**): "Former Prime Minister Lubbers, the spiritual father of the Charter, is present, but the most important partner country, the Russian Federation, is keeping up the suspense to the very last moment. Yesterday, it was not yet clear whether the government of the country that is the main focus of the Lubbers plan will show up to sign. (...)

(...) Their objections are understandable against the background of Moscow's battle against the country's mafia, which is trying to get its grip around the energy sector. Moscow is also troubled by the fact that the obligations will apply for all Russian republics and regions. This makes ratification by the Duma, the federal parliament, more difficult, since all regions are represented in the Duma and may stand their ground." (emphasis added)

⁴⁵² Report of the parliamentary hearing on the ratification of the ECT, 26 January 2001, C-156, p. 34: "(...) the previous Duma did not manage to form a solid and persuasive majority with regard to it."

⁴⁵³ Report of the parliamentary hearing on the ratification of the ECT, 26 January 2001, C-156, p. 77. Original English text: "In February 1997, the State Duma held a seminar to study the provisions of the ECT and the Protocol. In July of that same year, the ECT and the Protocol were reviewed by the Russian Audit Chamber, and in June 1997, parliamentary hearings were held on issues of their ratification, which recommended that ratification of the ECT and the Protocol be postponed until Russia had joined the World Trade Organization (WTO)."

Gazprom's own calculations, the Treaty would result in a drop in prices and, consequently, export income.⁴⁵⁴

317. Investors cannot rely on their unfamiliarity with the legal system. They should be considered familiar with the political system, the business climate and the general legislative framework of the host state.⁴⁵⁵ Any investor could have discovered without any effort that it was in no way certain that the Russian Federation would ratify the Treaty. An investor could and should have taken all this into account.

(d)(ii)(iii) *The Russian Federation has repeatedly indicated that parts of the Treaty are inconsistent with Russian law*

318. HVY assert that the Russian Federation previously stated that the entire Treaty was compatible with Russian law.⁴⁵⁶ HVY claim that the Russian Federation's statement – that public-law disputes are not arbitrable under Russian law – “*was of course set up only to avoid responsibility for the expropriation of Yukos*”.⁴⁵⁷ They accuse the Russian Federation of making a “*turnaround that caused quite a stir*”⁴⁵⁸ because, supposedly, earlier positions “*no longer suited*” it.⁴⁵⁹ They accuse the Russian Federation of “*making up*” a new argument.⁴⁶⁰ In reality, however, there never was a “*turnaround that caused quite a stir*” or

⁴⁵⁴ Report of the parliamentary hearing on the ratification of the ECT, 26 January 2001, C-156, p. 53.

⁴⁵⁵ See *Duke Energy Electroquil Partners and Electroqsuil S.A. v. Republic of Ecuador*, ICSID Case No. ARB/04/19, Award, 18 August 2008, § 340, in which the tribunal found that: “*foreign investor's expectations must be based on the political, socioeconomic, cultural and historical conditions prevailing in the host State*”. See also *Parkerings-Compagniet AS v. Republic of Lithuania*, ICSID Case No. ARB/05/8, Award, 11 September 2007, §§ 306, 335-336, which emphasises the necessity for an investor to have knowledge of current and future legislation. Original English text: “*it would have been foolish for a foreign investor in Lithuania to believe, at that time, that it would be proceeding on stable legal ground, as considerable changes in the Lithuanian political regime and economy were undergoing. ... In 1998, at the time of the Agreement, the political environment in Lithuania was characteristic of a country in transition from its past being part of the Soviet Union to candidate for the European Union membership.*”

⁴⁵⁶ See the summary of the position during the Arbitrations in the HEL Interim Award, marginal 359. See SoD, Part II, §§ 201-214 and SoRej., §§ 83-91. See HEL Interim Award, marginal nos. 359, 374, 375. The Tribunal gave a distorted picture of the source text, in marginal 374 especially, by citing only parts thereof.

⁴⁵⁷ SoD, Part I, § 43. See also SoD, Part II, § 195: “*But because the Russian Federation basically decided to nationalise Yukos's means of energy production without offering any compensation, Yukos, confronted with a claim worth billions, saw itself forced to come up with arguments with which to evade its international obligations. The Russian Federation (...) diligently tried to find provisions in Russian law that it could spin in such a way that, with a little luck, they could be considered inconsistent with the ECT.*”

⁴⁵⁸ SoD, Part II, § 59.

⁴⁵⁹ SoD, Part I, § 44, SoD, Part II § 195.

⁴⁶⁰ SoA, §§ 179-180 and 544.

a “*made-up argument*”. HVY’s assertion that prior to the Arbitrations it was never indicated that parts of the Treaty were not applied provisionally is simply incorrect.⁴⁶¹

319. In reality, the Russian Federation made it clear many times that its laws are inconsistent with the ECT and require amendment on numerous points. This is hardly surprising; at that time, the Russian Federation was still faced with legislation originating from the Soviet era, which had not been adapted to the principles of the free market that provided the framework for the formation of the ECT.⁴⁶²
320. During the negotiations, the Russian Federation more than once provided lists for the so-called “Annex A” and “Annex T” to the Treaty.⁴⁶³ Each of these lists names over twenty specific Russian laws that obstruct the envisaged free trade and are inconsistent with the proposed treaty obligation to treat foreign investors on equal footing (“*national treatment*”). These lists mostly pertain to the question whether Article 10 ECT is compatible with Russian law. By way of example, the Russian Federation quotes some parts of one of these lists:

“COUNTRY: RUSSIA

MEASURES

⁴⁶¹ SoA, § 180. See Professor Nolte’s 2017 Expert Opinion (**Exhibit RF-D2**), §§ 60-76, in which it is explained that HVY’s conclusions do not follow from the sources cited by them.

⁴⁶² English translation of the original Russian text (**Exhibit RF-266**): “*The RUF delegation first listed the numerous laws it has in preparation, notably on foreign investments, on oil and gas, on licensing and exploitation of mineral resources, on concessional relations and production sharing, on the continental shelf, on nuclear power, on the conservation of energy and on the work of power stations. Most are only at an initial stage, two are before Parliament. Due to the heavy burden on both Government and Parliament, it is physically impossible to predict when Russia will be in a position to terminate its exceptions, and implement the commitments contained in the Charter Treaty. No commitment can therefore be made by Russia to the final date of 1.1.1998 put forward for the end of all exceptions, and other CIS countries are expected to be in the same position. Moreover, the law can only follow the economy, not the reverse: Russia will be able to implement the whole Charter Treaty when it has a market economy. One possibility is to accept the final date generally, but allow some exceptions without a time limit, making them dependent on the developments towards a market economy.*”

⁴⁶³ Five documents are entered into the proceedings by way of example. See, among others, ECT Draft Annexes T, List of countries’ specific transitional measures (version 2) Russia dated 1 May 1993 (**Exhibit RF-284**), ECT Draft Annexes T, List of countries’ specific transitional measures (List of Countries eligible for Transnational Arrangements)(version 2) dated 1 May 1993 (**Exhibit RF-285**), ECT Draft Annexes A, Existing barriers to national treatment (version 2) Russia (**Exhibit RF-286**), ECT Draft Annexes A, Existing barriers to national treatment (List of Countries)(version 2) dated 1 May 1993 (**Exhibit RF-287**), European Energy Charter Conference Secretariat, Annexes T (version 4) dated 24 September 1993 (**Exhibit RF-288**).

The Decision of the Council of Ministers of the RSFSR of 3 December 1990 "On the Use of Monetary Means In Soviet Roubles by Foreign Firms In the Territory of the RSFSR" (para. 1). (...) Foreigners are not permitted to acquire for roubles buildings and structures, except incompleated ones. Other restrictions may also be established for foreigners. (...)

The Land Code of the Russian Federation of 25 April 1991 (Articles 3,7, 13). (...) Plots of land may not be transferred to foreign citizens into ownership and into inherited possession for life (only for use).(...)

The Regulations Concerning Licensing of Subsoil Use (approved by the Decision of the Supreme Soviet of the RF of 15 July 1992). (...) It is permitted to hold tenders and auctions in individual cases for small enterprises of the prospectors' team type for defence enterprises carrying out conversion programmes, with participation of domestic enterprises only. This implies that foreigners may not be admitted to such tenders and auctions. (...)

The Water Code of the RSFSR of 30 June 1972 (Article 18). (...) Foreigners may be water users only in cases specifically provided for by legislation.

(...) The Forest Code of the RSFSR, 1978 (Article 45). (...) Foreigners may be forest users only in cases specifically provided for by legislation."⁴⁶⁴

321. The Explanatory Memorandum to the government proposal to ratify the ECT also confirms that the ECT sets rules that deviate from existing legislation ("*different from those envisaged by laws*").⁴⁶⁵ The memorandum shows that the Treaty would require a further

⁴⁶⁴ European Energy Charter Room document 10 on existing trade barriers - RF Annexes A (**Exhibit RF-289**).

⁴⁶⁵ HVY's assertion that the government supposedly concluded that *all* treaty provisions were *always* consistent with Russian law even *without* approval or ratification is therefore incorrect. See SoA, §§ 170-173, 704-710, SoD, §§ II.202-204 and SoRej., §§ 83-88. For a rejection of this position, see also SoR, §§ 117-128, Professor Asoskov's 2017 Expert Opinion (**Exhibit RF-D5**), §§ 135-139, and Professor Nolte's 2017 Expert Opinion (**Exhibit RF-D2**), §§ 60-76. The District Court rightfully rejected this position. The memorandum does not pertain to the consistency of the ECT with Russian laws from the perspective prior to ratification (pre-ratification). The District Court correctly ruled that the Explanatory Memorandum contains nothing that specifically pertains to the consistency of Article 26 ECT with Russian law: "5.60. *It is the court's opinion that in assessing the meaning of the explanatory memorandum the Tribunal insufficiently recognised that this memorandum originated from the executive and was primarily aimed at prompting the Duma, as part of the legislature, to ratify the ECT. Since the ECT was never ratified, the opinion of the executive (the government) cannot be ascribed to the legislature and the government's standpoint therefore does not have independent meaning. This observation alone necessitates an assessment of (the relevance of) the explanatory memorandum from the government with the utmost restraint. This is all the more relevant since the explanatory memorandum only discusses the compatibility of the ECT with Russian laws in general terms. For instance, the arbitral provision of Article 26 ECT is not explicitly stated in the explanatory memorandum. Furthermore, the court follows the standpoint taken by the Russian Federation on this aspect that the remark of the government that (the regime of) the ECT is in line with Russian law and 'does not require the acknowledgement of any concessions or the adoption of any amendments' of Russian legislation, should be viewed against the backdrop of the intended ratification. Whether or not the ratification of the ECT and more specifically of Article 26 would require and adjustment of Russian legislation, is a wholly*

implementation in various areas.⁴⁶⁶ The government did add that this, by itself, need not preclude ratification of the Treaty, as the Russian Federation has a system that has some monistic features and the ECT, if it has been approved and has entered into force⁴⁶⁷, prevails over deviating (federal) laws:

"The ECT contains a number of legally binding provisions, based on the GATT provisions, that have yet to be reflected (or fully reflected) in the Russian legislation. This concerns the provisions relating to customs duties; protective and anti-dumping measures; duties with regard to the export and import of goods; subsidies; state enterprises; implementation of technical norms and standards; etc.

However, this issue is not an obstacle to the ratification of the ECT.

(...) under Russian law, international treaties of the Russian Federation are part of the country's legal system. If such treaties establish provisions different from those envisaged by laws, the provisions of the international treaty shall apply. In this case, such provisions will be applied not as general provisions of Russian law, but exclusively to relations with the Contracting Parties to the ECT, which have assumed similar obligations." (emphasis added)⁴⁶⁸

322. During the parliamentary debate on the legislative proposal to ratify the Treaty, the Duma rightfully assumed that the ECT deviated from existing laws on many points and would require further implementing or amending legislation.⁴⁶⁹ When the Treaty was discussed by the State Duma on 17 June 1997, at least four different speakers noted that there were conflicts between specific treaty provisions and Russian federal legislation.⁴⁷⁰ For that reason, the State Duma felt that the ratification of the Treaty would have to be postponed.
323. On 26 January 2001 another parliamentary hearing on the legislative proposal was held. A number of speakers – including former Prime Minister Chernomyrdin – noted that the ECT was inconsistent with existing Russian laws and regulations.⁴⁷¹ After the debate on the

different question than the question whether the provisional application of this provision is in accordance with Russian law. The latter question is not answered in the explanatory memorandum."

⁴⁶⁶ See also Writ, § 237, and SoR, §§ 123-124 and the sources cited therein (5-143), p. 4.

⁴⁶⁷ Only an approved treaty has priority under Russian law. See §§ 419-432 below.

⁴⁶⁸ Explanatory Memorandum (C-143), p. 4.

⁴⁶⁹ In SoA, § 174, HVY therefore wrongfully give the impression that the Duma established that all the Treaty's provisions corresponded with the existing Russian laws and regulations.

⁴⁷⁰ See Professor Avtonomov's Expert Opinion, (**Exhibit RF-D4**), §§ 94-98.

⁴⁷¹ See Professor Avtonomov's Expert Opinion (**Exhibit RF-D4**), §§ 94-98, in particular § 96 under f, Mr Katrenko's witness statement (**Exhibit RF-G1**), §§ 17-22.

legislative proposal ended, the State Duma formulated recommendations.⁴⁷² The State Duma requested the government to draw up a list of all laws that would require amendment if the Treaty were ratified:

"Having exchanged views, the participants of the parliamentary hearings recommend: 1. That the Government of the Russian Federation: (...) promptly draw up and submit it to the State Duma a list of legislative acts subject to amendment in the event that the Treaty is ratified (...)"⁴⁷³

324. That the Duma at the time assumed that the ECT deviated from existing laws on numerous points is clearly evident from the transcripts of the oral hearing.⁴⁷⁴ In addition, the Russian Federation offers to provide proof by examining witnesses, such as Mr Katrenko. Mr Katrenko was the chairman of the Duma Committee on Energy at the time. He can confirm that it was generally assumed at the time that large portions of the ECT were inconsistent with existing legislation.⁴⁷⁵
325. The above shows that each investor could determine that parts of the Treaty were inconsistent with the applicable Russian law (at the time). The Russian Federation also explicitly confirmed this more than once.

(d)(ii)(iv) *The Russian Federation confirmed more than once that arbitration of investment disputes is inconsistent with Russian law*

326. As indicated, HVY claim that the Russian Federation's statement – that public-law disputes are not arbitrable under Russian law – “*was of course set up only to avoid responsibility for the expropriation of Yukos*”.⁴⁷⁶ According to them, the Russian Federation was unable to point “*to even a single source in which anyone ever doubted*” the provisional application of Article 26 ECT.⁴⁷⁷ That is incorrect. Any investor at the time could easily establish that investment disputes had to be presented to a domestic court. That arbitration of investment

⁴⁷² See Mr Katrenko's witness statement (**Exhibit RF-G1**), § 23.

⁴⁷³ Report of the parliamentary hearing on the ratification of the ECT, 26 January 2001 (C-156), p. 78.

⁴⁷⁴ See Mr Katrenko's witness statement (**Exhibit RF-G1**).

⁴⁷⁵ See Mr Katrenko's witness statement (**Exhibit RF-G1**).

⁴⁷⁶ See § 318 and the sources in HVY's documents referred to therein. SoD, § I.43. See also SoD, § II.195: “*But because the Russian Federation basically decided to nationalise Yukos's means of energy production without offering any compensation, Yukos, confronted with a claim worth billions, saw itself forced to come up with arguments with which to evade its international obligations. The Russian Federation (...) diligently tried to find provisions in Russian law that it could spin in such a way that, with a little luck, they could be considered inconsistent with the ECT.*”

⁴⁷⁷ See SoA, § 38.

disputes pursuant to Article 26 ECT was inconsistent with Russian law was also confirmed more than once at the time.

327. Russian legislation is published and is therefore publicly available. This means that investors could have inspected the aforementioned laws that disallow arbitration of public-law affairs in the Russian Federation – just like in many other jurisdictions – at any time (see §§ 194 et seq.). There was never any change or turnaround. The laws and regulations were not changed on this point.⁴⁷⁸
328. The Russian Federation also made it clear in public documents that investment disputes are in principle not arbitrable under Russian law. In this context, the District Court rightfully referred to the parliamentary history of a large number of previously concluded and ratified bilateral investment treaties.⁴⁷⁹ This shows that Russian law does not provide for the arbitration of disputes such as the present one (see also §§ 223 and 441 et seq.). For example, parliamentary documents from the year 2000 regarding an investment treaty with South Africa show that the Law on Foreign Investments of 1991 does not provide for arbitration:

"RSFSR' No 1545-1 dated July 4, 1991 does not set forth for the mechanism of consideration of such disputes by international arbitration (...)"⁴⁸⁰

329. The Russian Federation has consistently contested the jurisdiction of arbitral tribunals to take cognisance of investment disputes in other arbitration proceedings as well. By way of example, the Russian Federation refers to the arbitral awards (now irrevocably) set aside in the RosinvestCo and Quasar arbitration proceedings started in 2005 and 2006 (other shareholders of Yukos Oil).⁴⁸¹

⁴⁷⁸ Writ, §§ 236-239 and SoR, §§ 113-128.

⁴⁷⁹ Judgment, ground 5.62.

⁴⁸⁰ Explanatory Note on the Issue of Ratification of the Agreement between the Government of the Russian Federation and the Government of the South African Republic for the Promotion and Reciprocal Protection of Investments (8 April 2000) (R-406).

⁴⁸¹ See the ruling of the Svea Court of Appeal of 18 January 2016 in the matter of *Quasar de Valores SICAV S.A. et al. v. The Russian Federation* (**Exhibit RF-218**). The arbitral award in the case *RosInvestCo UK Ltd. v. The Russian Federation* was set aside on 5 September 2013, also by the Svea Court of Appeal, see **Exhibit RF-76**. The Russian Federation took the position that it does not provisionally apply Article 26 ECT in other proceedings based on the ECT, too.

330. The Russian Federation also made this clear at the time of the ECT negotiations. As early as 13 October 1992, it informed all other negotiating States that – unless a treaty of the Russian Federation⁴⁸² provides otherwise – investment disputes must be presented to the domestic courts:

"Disputes arising from investment-related issues, including the amount, conditions or the procedure for paying compensation, shall be dealt with by the Supreme Court of the Russian Federation or the Supreme Court of Arbitration of the Russian Federation, unless otherwise stipulated by an international treaty." (emphasis added)⁴⁸³

331. In this context, see also a previously mentioned memorandum by the Russian Minister of Energy, drawn up in 2004 specifically with regard to the ECT (see § 229 above).⁴⁸⁴ The report makes it clear that, in the Russian Federation, only the courts are authorised to take cognisance of investment disputes:

"Justice in the Russian Federation is administered only by courts established in accordance to the Constitution of the Russian Federation and the Federal Constitutional Law mentioned above. The creation of extraordinary courts and courts that are not envisaged by this Law is not permitted. (...)." (emphasis added)⁴⁸⁵

332. During the parliamentary hearings on the legislative proposal to ratify the ECT, it was explicitly pointed out that Article 26 ECT is inconsistent with Russian law. The Russian Federation offers to prove this by examining witnesses, including Mr Katrenko. As chairman of the Energy Committee, he was actively involved in the parliamentary hearing of the legislative proposal at the time.

333. That Article 26 ECT is inconsistent with Russian law is also apparent from the verbatim written report of the oral hearing of the legislative proposal. This report shows, for example, that Professor G.A. Bystrov stated during the hearing of 17 June 1997 that he was worried about the fact that Article 26 ECT would affect the immunity of the Russian Federation. He indicated that Article 26 ECT deviated from existing legislation, such as the

⁴⁸² Referring to a treaty that has entered into force. See, among others, §§ 419-440 below.

⁴⁸³ Communication Russian Federation, Room Document 4 Working Group II, dated 13 October 1992, p. 4. (**Exhibit RF-298**).

⁴⁸⁴ HVY believe that, in this report, the Russian Federation confirmed that "*all investment disputes may be resolved by arbitration*" (SoA, § 168). That is incorrect. The reliance on this memorandum in SoA, § 588 holds no water either.

⁴⁸⁵ Russian Federation, Investment Climate and Market Structure in the Energy Sector (C-008), p. 36.

Law on the Subsoil. According to Prof. Bystrov Article 26 ECT would entail that the existing administrative procedures – e.g. those on licensing – could no longer be applied exclusively. He indicated that – if the Parliament wanted to maintain the existing system – it would have to reserve a special right with respect to the Treaty:

“Incidentally, the law on subsoil does not anticipate this possibility – the resolution of disputes, for example, in the International commercial arbitration court in Stockholm. And if we keep the administrative system of licensing for the use of subsoil, if we keep the related system of State control in this sphere, and the energy market will be crafted not only according to law on agreements of product sharing, then when ratifying this document the parliament must reserve a special right. *And current laws allow us to do that – Russia reserves its special dispute resolution system, not the one provided unconditionally and imperatively by Article 26...*” (emphasis added)⁴⁸⁶.

334. The arbitration clauses were discussed again in the public parliamentary hearing of 26 January 2001.⁴⁸⁷ For example, the vice-president of Transneft indicated that the dispute resolution mechanisms were not applied provisionally at that time. He indicated that he was a proponent of the Treaty’s ratification because ratification would allow the resolution of disputes by arbitration.⁴⁸⁸

⁴⁸⁶ See Professor Avtonomov's Expert Opinion, (**Exhibit RF-D4**), § 96, p. 46.

⁴⁸⁷ Mr Martynov then explained in the Duma, under the title "*The problem of dispute resolution under the Energy Charter Treaty*", that the ECT contains a more extensive and more detailed arrangement than all other investment treaties. Report of the parliamentary hearing on the ratification of the ECT, 26 January 2001, C-156, p. 48. Original English text: "*Of all the treaties concluded by the Soviet Union and Russia in the foreign economic area, this document probably contains the greatest number of possible dispute settlement options and very detailed descriptions of them.*" Martynov remarked that states are sovereign entities and that such binding dispute resolution mechanisms are always met with negative reactions for that reason: "*(...) indeed, states are sovereign entities, and a binding decision in a dispute always elicits many negative and complex reactions.*"

⁴⁸⁸ Report of the parliamentary hearing on the ratification of the ECT, 26 January 2001, C-156, p. 60. Original English text: "*(...) I would like to state that we support the ratification of the Treaty. (...) Let me emphasize that we are talking about oil transit here. In our work, we routinely have to face purely practical issues that have to be addressed. The notorious tariff issues for transit across Ukraine and gas offtake in Ukraine. We believe that these issues could be resolved through a mechanism provided by the Energy Charter, rather than by means of useless negotiations. (...) [T]here are no available mechanisms for its resolution at present. We contacted the Secretariat of the Charter on this issue. We received an official written response: ‘Dear colleagues, we admit that Ukraine is acting improperly and that its acts contradict both the spirit and letter of the Energy Charter, the Protocol, and the Treaty; however, we cannot consider this matter now because you have not ratified the Charter.’ That is it, and the issue was closed. Another example is a positive one, such as transit of the Russian oil through other countries. (...) [W]e have an intergovernmental agreement with Azerbaijan but, on the other hand, Azerbaijan fails to comply with it by sending its oil in the direction of Turkey, bypassing Russia, and so on. There is nothing we can do, even though, let me reiterate, there is an intergovernmental agreement. We cannot resolve this issue because we have no dispute resolution mechanism. So, there is virtually no transit across our territory (...)" (emphasis added). See the letter from the ECT Secretariat to the Russian Minister of Energy, re: Request for clarification and advice concerning potential transit dispute with Ukraine, dated*

335. The ultimate recommendations formulated further to the Duma's (second) hearing imply that it was generally assumed that ratification and entry into force were required before recourse could be taken to the dispute resolution mechanisms. The Duma discussed the advantages of the Treaty's ratification and entry into force. According to the Duma, the entry into force would allow the resolution of investment disputes through arbitration:

“The ECT's entry into force will (...) grant Russia additional opportunities to resolve disputes on an international level on issues of the transit of Russian energy resources and foreign investments; (...)”(emphasis added)⁴⁸⁹

(d)(ii)(v) *Conclusion*

336. The above shows that there is no factual basis for HVY's reliance on acquiescence and estoppel. The text of the Treaty and the Russian legislation is not only clear but also publicly available. The Russian Federation consistently confirmed (i) that it would apply the ECT provisionally only to the extent that this was consistent with its national legal system and (ii) that investment disputes must be presented to the domestic courts. Accordingly, the Duma's public debate started from the assumption that the arbitration clauses could not be applied until after the Treaty's approval and entry into force. For that reason alone, the reliance on estoppels and acquiescence fails.

337. Below, it will be explained that the reliance on estoppel and acquiescence also fails on legal grounds (see §§ 338-364). As the Tribunal rightly considered, the conditions for estoppel have in any event not been satisfied. The unilateral statements by the officials of the Russian Federation at any rate cannot justify deviation from the clear text of Article 45

28 June 2000 (**Exhibit RF-290**) [2000.06.28-RB16-01]. It must be noted that this matter pertained primarily to dispute resolution regarding transit.

Original English text: *"As for the clarification you ask concerning dispute settlement mechanisms under the Energy Charter Treaty ('ECT'), I will highlight only those which are relevant to your request.*

- *Article 27 of the ECT provides for the settlement of disputes between Contracting Parties (...)*
- *Article 26 of the ECT provides for an elaborate mechanism for the settlement of disputes between an Investor and a Contracting Party (...)*

You rightly mention in your letter that Ukraine is a Contracting Party to the ECT, whereas the Russian Federation applies it on a provisional basis. I have been advised that this might cast some doubt on whether the Russian Federation is entitled to bring a claim against Ukraine under the terms of the Treaty. This doubt will however be removed when the Russian Federation ratifies the Energy Charter Treaty thus enjoying all of its benefits, including access to the various dispute settlement mechanisms mentioned above."

⁴⁸⁹ Report of the parliamentary hearing on the ratification of the ECT, 26 January 2001, C-156, p. 77.

ECT. Nor is it relevant whether separate investors consult such documents and, if so, what subjective conclusions they may draw from them.

(d)(iii) *The reliance on the IMS/DIO ruling and Article 10:167 DCC fails*

338. In their Statement of Appeal, HVY rely on the legal rule following from Supreme Court judgment of 28 January 2005, in *NJ 2006/469 (IMS/DIO)* for the first time. The ruling pertained to the delivery of combat vehicles by an English enterprise, IMS, to a legal entity affiliated with the Iranian Ministry of Defence, DIO. After a dispute arose between the parties, DIO proposed to have this dispute resolved by arbitration. The parties reached an agreement on this by fax. The arbitrators who were then appointed found IMS to be in the right and ordered DIO to pay damages. In the setting aside proceedings, DIO argued that the arbitration agreement concluded earlier should be considered null or invalid because it had not been approved by the Iranian Parliament. In the *IMS/DIO* ruling, the Supreme Court ruled that a limitation of power cannot be invoked if the other party was not or could not have been aware of this limitation. This rule was codified in Article 10:167 DCC at a later date.

339. For the sake of completion, the relevant legal finding of the Supreme Court in the *IMS/DIO* ruling is quoted below:

“3.3 In ground 3.6, the court of appeal rejected DIO’s reliance on the nullity of the arbitration agreement for being contrary to Article 139 of the Iranian Constitution. To that end, the court of appeal held as follows in ground 4.2, among others:

‘(...) It is now a widely accepted international principle that a State or an organisation that is part of a State – which the parties agree DIO is – is not entitled to invoke its own internal law to argue that an agreement concluded by it, which provides for international arbitration, is invalid. (...)’

3.6.2 Under Dutch private international law, (...) an invocation of limitations of power is impossible with respect to the counterparty that neither was nor reasonably ought to have been aware of these limitations: in principle, the party that, in international legal transactions, relies in good faith on the other party’s power to act is protected. The complaint therefore fails, because the rule applied by the court of appeal is part of Dutch private international law. (...)” (emphasis added)

340. HVY assert that the *IMS/DIO* ruling means that the Russian Federation presently may no longer invoke Article 45 ECT. This is incorrect for the following reasons.

UNOFFICIAL TRANSLATION

This text is an unofficial translation of the Dutch original. In case of any discrepancies, the Dutch original shall prevail.

341. First: HVY ignore the fact that the Tribunal has already rejected their statements and arguments. In their Statement of Appeal, they have not contested this finding of the Tribunal (in an apparent manner). They present their arguments as if they are entirely new. However, as explained above, the reliance on the *IMS/DIO* ruling is nothing more than an elaboration of an argument that has already been irrevocably rejected by the Tribunal (see §§ 306-307 above). Accordingly, this argument can no longer be discussed (see §§ 257-267 above).
342. It should be noted that it would be of no help to HVY if they took the (wrong) position that the reliance on the *IMS/DIO* ruling must be considered an entirely new legal argument. Indeed, an entirely new argument cannot be brought up for discussion in setting aside proceedings either. Only a positive ruling on jurisdiction can be reviewed (see §§ 257-267 above). HVY have moreover forfeited their right to rely on the *IMS/DIO* ruling, as it is incompatible with due process of law to work out an entirely new legal argument for the first time in setting aside proceedings (see §§ 268-277 above).
343. It is explained only for the sake of argument below that the *IMS/DIO* ruling does not apply.
344. Second: contrary to the *IMS/DIO* ruling, the Russian government never proposed to HVY to submit the dispute between the parties to arbitrators. No written or oral agreement with the government was ever reached in this case. In fact: HVY do not mention a single document, letter or statement specifically addressed to them that could give rise to an expectation on their part that the Russian Federation would want to submit the dispute to arbitrators. Whether a once “*concluded agreement*” is null or nonbinding in retrospect is therefore irrelevant in this case. The *IMS/DIO* ruling is irrelevant to the resolution of this dispute for that reason.
345. Third: these proceedings are not about whether or not a Russian representative or government official exceeded his powers. No single government official has made an offer to settle the dispute with HVY through arbitration. Consequently, there is no excess of internal rules on the power to conclude an arbitration agreement and the *IMS/DIO* ruling is irrelevant to the resolution of this dispute for that reason as well.

346. Fourth: HVY rightfully establish that Article 45 ECT points to the possibility of the existence of limitations on power.⁴⁹⁰ HVY knew, or at least should have known that the Russian Federation would not apply the Treaty or its provisions provisionally if such application would be contrary to its constitution, laws or regulations. This is apparent from the text of Article 45 ECT and was confirmed by the Russian Federation more than once later on (see §§ 123-129 and §§ 326-335 above). This general limitation pertains to the provisional application of the Treaty and naturally affects the application of Article 26 ECT. In short: the reliance on the *IMS/DIO* ruling cannot hold in any event, because HVY were aware, or at least should have been aware of the explicit limitations on the provisional application of (Article 26 of) the Treaty.⁴⁹¹
347. Fifth: the *IMS/DIO* ruling is based on the doctrine of good faith. In this case, the Russian Federation has not in any way acted contrary to good faith. Although HVY have scrutinised every document submitted on the part of the Russian Federation, they have failed to find even a single document proving that the Russian Federation declared that it would provisionally apply Article 26 ECT. There was no question of statements or conduct that justify a reliance on good faith.⁴⁹² Nor was there any culpable silence; indeed, the Russian Federation indicated repeatedly that the scope of the provisional application was limited and that investment disputes must be presented to the domestic courts (see §§ 123-129 and §§ 326-335 above).
348. Sixth: parties such as HVY, who undisputedly participate and are involved actively in a large number of fraudulent acts, cannot rely on good faith.⁴⁹³

(d)(iv) *The reliance on estoppel and acquiescence under international law fails*

349. HVY further rely on the principles of acquiescence and estoppel⁴⁹⁴ under international law.⁴⁹⁵ They argue that these principles prevent the Russian Federation – which, according

⁴⁹⁰ SoA, § 199.

⁴⁹¹ HVY appear to explicitly recognise this in SoA, § 196.

⁴⁹² The Russian Federation therefore disputes the factual statements in SoA §§ 201-206.

⁴⁹³ See chapter III below for a further elaboration of this point. See also SoR, § 28, Final Awards, marginal nos. 1283-1309, and the Respondent Counter Memorial, §§ 18-31.

⁴⁹⁴ For a similar translation and a very brief description of these terms, see A. Nollkaemper, *Kern van het internationaal publiekrecht*, Bju Den Haag 2016 (seventh edition), § 5.8.

⁴⁹⁵ See SoA, §§ 208-227.

to HVY, consistently expressed that the ECT should be applied provisionally without any limitation – from putting up a defence against the grounds for appeal on appeal.

350. First: HVY again make it seem as if the reliance on estoppel and acquiescence is an entirely new argument. They ignore the assessment of the Tribunal, which was to their detriment. The Tribunal explicitly rejected the reliance on estoppel. As discussed above, only the correctness of a positive ruling on jurisdiction may be reviewed in setting aside proceedings. Consequently, HVY's reasoning cannot be discussed (see §§ 257-258, 307, and 308 above).
351. It should be noted that, even if it does in fact involve an entirely new argument, HVY's reliance on estoppel and acquiescence still fails. In that case, too, it holds that proceedings such as the present one, only allow for a discussion of the correctness of a positive ruling on jurisdiction. Moreover, it is not allowed to introduce entirely new arguments, seeing that this is contrary to due process of law. (see §§ 268-277 above).
352. Second: these proceedings are pending before the Dutch domestic court. The question whether particular statements or defences of the Russian Federation can be addressed on appeal is exclusively governed by Dutch law on appellate procedure. Dutch law on appellate procedure has its own rules on acquiescence⁴⁹⁶, (procedural) estoppel⁴⁹⁷ and abandoned arguments.⁴⁹⁸ HVY rightly decided not to rely on acquiescence or estoppel under Dutch law, as this would have certainly failed.⁴⁹⁹ HVY rely exclusively on the general principles of acquiescence and estoppel under international law. To the extent that

⁴⁹⁶ See, for example, Articles 334 and 400 DCCP on acquiescence. In that case, a juridical act must be directed at another party. Compare Supreme Court 10 March 2017, *NJ* 2017/135: " 3.5 (...) *Acquiescence can exist only if the party found to be in the wrong has declared, after the judgment, towards the other party that it acquiesces in the judgment or has adopted an attitude which demonstrates this unambiguously in light of the circumstances of the case. If the other party has concluded from the statements made by the party found to be in the wrong and could reasonably conclude from the given circumstances that these have unambiguously expressed its will to acquiesce in the judgment, the other party can no longer rely on the absence of such will.*" (emphasis added)

⁴⁹⁷ See, for example, Supreme Court 9 July 2010, *NJ* 2010/418.

⁴⁹⁸ For example, Article 358 DCCP provides that forfeited defences are not addressed. A forfeited defence is a defence that has been abandoned unambiguously. See Supreme Court 18 January 1996, *NJ* 1996/709.

⁴⁹⁹ Generally, Dutch law requires a legal position to be abandoned unambiguously. The Russian Federation never abandoned its right to rely on certain positions.

these principles are even accepted internationally, they are not applicable in this case.⁵⁰⁰ HVY's line of reasoning must be disregarded for that reason as well.

353. Third: HVY's argument is based on the assertion that, after signing, the Russian Federation repeatedly confirmed that it would provisionally apply the Treaty in its entirety. The Russian Federation itself allegedly "*gave no indication whatsoever*" that the provisional application would be subject "*to any limitation*".⁵⁰¹ These assertions are incorrect. On the contrary, the Russian government officials repeatedly pointed to the limited scope of the provisional application (see the statements cited in § 124 above). For example, the Russian Federation indicated several times that it applied the treaty provisionally "*to the extent that it is not inconsistent with the constitution, laws and regulations*". The Russian Federation therefore relied on the clear text of Article 45(1) ECT in good faith and in full transparency.⁵⁰² It also indicated several times that investment disputes must be resolved by the domestic court (see §§ 123-129 and §§ 326-335 above).
354. Fourth: The principles of acquiescence and estoppel are nothing more than a further elaboration of the principles of *pacta sunt servanda* and good faith.⁵⁰³ This has no independent significance in addition to the provisions of Articles 26 and 27 VCLT. The Russian Federation again points out that there is no inconsistency with these principles (see §§ 365-370 above).
355. Finally: Even if HVY's arguments were factually correct, they are insufficient for a successful reliance on estoppel or acquiescence under international law. Professor Nolte concludes as follows in his expert opinion:

“The conduct and the statements, upon which Klabbers and Schrijver rely, of the Russian Federation during the ECT's negotiations and subsequent to its

⁵⁰⁰ HVY do not refer to even a single specific treaty provision that is binding on all parties and that might be applicable in this case. They also fail to explain why a Dutch court should give a judgment that deviates from Dutch procedural law.

⁵⁰¹ SoA, §§ 219, 221, 223 and 225

⁵⁰² That the Russian Federation (like the Netherlands and France, among others) did not make a declaration is correct and understandable. Of course, this is not a circumstances to assume that Article 45(1) ECT can no longer be relied on. See chapter II.D(c) above. HVY's argument that failing to make a declaration would subsequently be a reason to be bound by the entire Treaty on the basis of the doctrines of estoppel and acquiescence cannot hold (SoA, §§ 219-220).

⁵⁰³ See also the expert opinions of Professor Klabbers, §§ 133 and 134, and Professor Schijvers, § 39, submitted by HVY.

signature of the ECT, even if they are interpreted as HVY suggest, clearly do not satisfy the conditions prescribed for estoppel or acquiescence in the established practice of international courts and tribunals (...)

The Russian Federation, after signing the ECT, did not act or speak in a way which excludes its invocation under Article 45 (1) ECT of a rule of internal (constitutional) law according to which it could not agree, by way of provisional application, to submit to arbitration under Article 26 ECT. (...)

The application of the principle of good faith, including the doctrines of estoppel and acquiescence, to the conduct of the Russian Federation, does not have the consequence under international law that the Russian Federation is not entitled to invoke its internal law under Article 45 (1) ECT.⁵⁰⁴

(d)(iv)(i) *Estoppel*

356. It is highly questionable whether the doctrine of estoppel is an established principle of international law. In his academic publications, Professor Klabbers, HVY's expert, rightly pointed out that the doctrine is "mystical", "nebulous" and that "its very existence" is challenged:

"The doctrine of estoppel surely ranks as one of the more mystical doctrines in international law. Apart from the fact that sometimes its very existence is challenged, its contents are rather nebulous."⁵⁰⁵

357. If it is assumed that there exists a generally established principle of estoppel under international law, the threshold for a reliance on such principle is clearly (and undisputedly⁵⁰⁶) high. Those relying on the doctrine of estoppel must provide sufficient arguments to satisfy this "high threshold".⁵⁰⁷ Reliance on the estoppel doctrine can only be successful if each of the following requirements are met:

⁵⁰⁴ Professor Nolte's 2017 Expert Opinion (**Exhibit RF-D2**), III. Conclusions.

⁵⁰⁵ Jan Klabbers, *The Concept of Treaty in International Law* (The Hague: Kluwer, 1996), p. 93.

⁵⁰⁶ As HVY acknowledge, a successful reliance on estoppel or acquiescence under international law in any event requires a clear and unambiguous declaration or action by a competent state body. SoA, § 217: "*The ICJ case law shows that both principles require that there must be a clear and unequivocal statement or action with respect to a certain factual or legal situation, which has been made or performed by an authorised body of a state.*"

⁵⁰⁷ *Chevron Corporation (U.S.A.) and Texaco Petroleum Corporation (U.S.A.) v. The Republic of Ecuador*, UNCITRAL Arbitration, Interim Award, 1 December 2008, § 143. Translation of the original text: "*in all legal systems, the doctrines of abuse of rights, estoppel and waiver are subject to a high threshold. Any right leads normally and automatically to a claim for its holder. It is only in very exceptional circumstances that a holder of a right can nevertheless not raise and enforce the resulting claim.*" (Original English text: "*in all legal systems, the doctrines of abuse of rights, estoppel and waiver are subject to a high threshold. Any right leads normally and automatically to a claim for its holder. It is only in very exceptional circumstances that a holder of a right can nevertheless not raise and enforce the resulting claim.*").

- (a) a State must make a clear and unambiguous statement with regard to a certain situation;
- (a) the statement of fact must be made voluntarily, unconditionally, and by the authorised body; and
- (b) the reliance on the statement must be in good faith, either to the detriment of the party relying thereon or to the advantage of the party making the statement.⁵⁰⁸

358. In order for the representations to be clear and unambiguous, the relevant question is whether the language employed in any given declaration does reveal a clear intention to be bound.⁵⁰⁹ In this regard, the ICJ observed that “a [unilateral] statement of this kind can create legal obligations only if it is made in clear and specific terms.”⁵¹⁰ Moreover, unilateral declarations are subject to restrictive interpretation.⁵¹¹ The Russian Federation

⁵⁰⁸ Derek W. Bowett, *Estoppel Before International Tribunals and Its Relation to Acquiescence*, British Yearbook of International Law 33 (1957), p. 176, p. 202.

⁵⁰⁹ *Nuclear Tests (Australia v. France)*, Judgment of 20 December 1974, I.C.J. Reports 1974, p. 253, p. 268, § 45 (quoting *Case concerning the Temple of Preah Vihear (Cambodia v. Thailand), Preliminary Objections*, Judgment of 26 May 1961, I.C.J. Reports 1961, p. 17, p. 32); *Nuclear Tests (New Zealand v. France)*, Judgment of 20 December 1974, I.C.J. Reports 1974, p. 457, p. 473, § 48 (quoting *Case concerning the Temple of Preah Vihear (Cambodia v. Thailand), Preliminary Objections*, Judgment of 26 May 1961, I.C.J. Reports 1961, p. 17, p. 32). The ICJ conditioned any legally binding effect of a unilateral declaration on it having been given publicly, and with an intent to be bound. The ICJ considered as follows: “When it is the intention of the State making the declaration that it should become bound according to its terms, that intention confers on the declaration the character of a legal undertaking, the State being thenceforth legally required to follow a course of conduct consistent with the declaration.” (Original English text: “When it is the intention of the State making the declaration that it should become bound according to its terms, that intention confers on the declaration the character of a legal undertaking, the State being thenceforth legally required to follow a course of conduct consistent with the declaration.”) *Nuclear Tests (Australia v. France)*, Judgment of 20 December 1974, I.C.J. Reports 1974, p. 253, p. 267, §§ 43 and 46.

⁵¹⁰ *Armed Activities on the Territory of the Congo (New application: 2002) (Democratic Republic of the Congo v. Rwanda), Jurisdiction and Admissibility*, Judgment of 3 February 2006, I.C.J. Reports 2006, p. 6, p. 28, § 50 (citing the *Nuclear Tests* cases). See also Guiding Principles Applicable to Unilateral Declarations of States Capable of Creating Legal Obligations, with Commentaries, Principle 7, Yearbook of the International Law Commission 2006, Vol. II, Part 2, p. 369, at p. 377. Original English text: “A unilateral declaration entails obligations for the formulating State only if it is stated in clear and specific terms.”

⁵¹¹ In the *Nuclear Tests* cases, the ICJ further limited the effect of unilateral declarations, finding that: “[w]hen States make statements by which their freedom of action is to be limited, a restrictive interpretation is called for.” (emphasis added) (Original text: “[w]hen States make statements by which their freedom of action is to be limited, a restrictive interpretation is called for.” (emphasis added)) *Nuclear Tests (Australia v. France)*, Judgment of 20 December 1974, I.C.J. Reports 1974, p. 253, p. 267, § 44 (emphasis added); *Nuclear Tests (New Zealand v. France)*, Judgment of 20 December 1974, I.C.J. Reports 1974, p. 457, p. 472, § 47. See also Guiding Principles Applicable to Unilateral Declarations of

never made any statements during the negotiations or after signature of the ECT that could contain any acceptance of the Russian Federation's provisional application of Article 26 ECT, nor that the ECT's provisions were entirely compatible with Russian law (see §§ 318-335).⁵¹² On the contrary, the Russian Federation consistently stated that the scope of its provisional application of the ECT was limited (also see §§ 123-129 and 318-335).

359. The Tribunal rightly found that the Russian Federation never used such wording:

“288. Applying the standard thus established by the ECJ, the Tribunal concludes that the present case does not satisfy the conditions for the existence of a situation of estoppel. The Tribunal finds that the estoppel argument fails principally because Respondent's support for provisional application of the ECT during the negotiations, even if it could be considered ‘consistent’, never ‘clearly’ excluded the possibility that Respondent was in fact relying on its interpretation of the operation of the Limitation Clause in Article 45(1) which would in any event exclude or limit provisional application of the Treaty.”⁵¹³ (emphasis added)

360. In addition, HVY fail to show that the Russian Federation made an unconditional and authorised statement.⁵¹⁴ Representatives of the Russian Federation consistently declared that the provisional application of the ECT was conditional, i.e. dependent on national laws and regulations. HVY moreover fail to acknowledge that the Russian government was not authorised to promulgate federal laws or to make (binding) declarations on the interpretation of federal legislation (see §§ 171 et seq.).⁵¹⁵

States Capable of Creating Legal Obligations, with Commentaries, Principle 7, Yearbook of the International Law Commission 2006, Vol. II, Part 2, p. 369, p. 377: "*In the case of doubt as to the scope of the obligations resulting from such a declaration, such obligations must be interpreted in a restrictive manner.*" In a subsequent case, the ICJ found: "*that it has a duty to show even greater caution when it is a question of a unilateral declaration not directed to any particular recipient*" (emphasis added). *Frontier Dispute (Burkina Faso/Republic of Mali)*, Judgment of 22 December 1986, I.C.J. Reports 1986, p. 554, p. 574, § 39.

⁵¹² Contrary to what HVY would have this Court believe based on HVY's selective and out-of-context quotes from certain documents, those same documents and others show that the Russian Federation has in fact always stated that the scope of its provisional application of the ECT was limited. See SoA, §§ 145-182, 218-227; Schrijver's Expert Opinion (HVY), §§ 115-137; Klabbers's Expert Opinion, §§ 122-130. See also Professor Nolte's 2017 Expert Opinion (**Exhibit RF-D2**), §§ 60-74.

⁵¹³ HEL Interim Award, marginal 288.

⁵¹⁴ See Professor Nolte's 2017 Expert Opinion (**Exhibit RF-D2**), § 29.

⁵¹⁵ *Delimitation of the Maritime Boundary in the Gulf of Maine Area (Canada/United States of America)*, Judgment of 12 October 1984, I.C.J. Reports 1984, p. 246, p. 307, § 139. In this case, the ICJ found that correspondence between mid-level government officials of the United States and Canada referencing the equidistant method of delimitation of the continental shelf did not have the effect of prejudging the United States' position in subsequent negotiations with Canada regarding the application of that method, because there was "*nothing to show that that method had been adopted at government level*".

361. Lastly, HVY have not alleged, let alone proven, that they relied to their detriment on any of the Russian Federation's statements that they invoke as a basis for their estoppel argument. Nor have HVY alleged any change of position or prejudice on the basis of the Russian Federation's statements.⁵¹⁶ The third requirement of good faith reliance is "essential" to a successful reliance on the principle of estoppel under international law.⁵¹⁷ This is confirmed by the case law of the ICJ,⁵¹⁸ by international courts and tribunals,⁵¹⁹ as well as

⁵¹⁶ See Professor Nolte's 2017 Expert Opinion (**Exhibit RF-D2**), §§ 13-15. In the *North Sea Continental Shelf Cases*, the ICJ, as noted above, held that past declarations of a State could have legal effects with respect to an asserted legal regime only if they clearly and consistently evidence acceptance of that regime and "also had caused [the other State], in reliance on such conduct, detrimentally to change position or suffer some prejudice." (Original English text: "also had caused [the other State], in reliance on such conduct, detrimentally to change position or suffer some prejudice.") *North Sea Continental Shelf Cases (Federal Republic of Germany/Denmark; Federal Republic of Germany/Netherlands)*, Judgment of 20 February 1969, I.C.J. Reports 1969, p. 3, p. 26, § 30. HVY rely on the ICJ's ruling in the *Nuclear Tests* cases, arguing that States may be bound by their own unilateral declarations. In this context, they cite the expert opinions of Professors Schrijvers and Klabbers. It bears noting, however, that Professor Klabbers has found the ICJ's judgments in *Nuclear Tests* to be "vulnerable to strict criticism", for the following reasons: "one may all well wonder ... whether unilateral statements are a recognized mode of law-making to begin with. (...) One may also wonder whether France actually intended to be bound...". Jan Klabbers, *International Law* (Cambridge University Press, 2013), p. 36.

⁵¹⁷ Derek W. Bowett, *Estoppel Before International Tribunals and Its Relation to Acquiescence*, British Yearbook of International Law 33 (1957), p. 176, p. 202. The International Court of Justice confirmed this definition of estoppel in the *North Sea Continental Shelf Cases*, holding that a State could be bound to a particular legal regime by estoppel only if "past conduct, declarations, etc." of that State "clearly and consistently evidence acceptance of that regime" and "also had caused [the other State], in reliance on such conduct, detrimentally to change position or suffer some prejudice" *North Sea Continental Shelf Cases (Federal Republic of Germany/Denmark; Federal Republic of Germany/Netherlands)*, Judgment of 20 February 1969, I.C.J. Reports 1969, p. 3, p. 26, § 30. See also SoA, § 214.

⁵¹⁸ *Land, Island and Maritime Frontier Dispute (El Salvador/Honduras)*, Application to Intervene, Judgment of 13 September 1990, I.C.J. Reports 1990, p. 92, p. 118, § 63: "some essential elements required by estoppel: a statement or representation made by one party to another and reliance upon it by that other party to his detriment or to the advantage of the party making it". See also *Land and Maritime Boundary between Cameroon and Nigeria (Cameroon v. Nigeria)*, Preliminary Objections, Judgment of 11 June 1998, I.C.J. Reports 1998, p. 275, p. 303, § 57: "An estoppel would only arise if by its acts or declarations Cameroon had consistently made it fully clear that it had agreed to settle the boundary dispute submitted to the Court by bilateral avenues alone. It would further be necessary that, by relying on such an attitude, Nigeria had changed position to its own detriment or had suffered some prejudice" See also *Case concerning the Temple of Preah Vihear (Cambodia v. Thailand)*, Merits, Judgment of 15 June 1962, I.C.J. Reports 1962, p. 6, p. 63. Separate Opinion of Judge Fitzmaurice: "The essential condition of the operation of the rule of preclusion or estoppel, as strictly to be understood, is that the party invoking the rule must have 'relied upon' the statements or conduct of the other party, either to its own detriment or to the other's advantage"; id. op p. 143-44, Dissenting Opinion of Judge Spender: "the principle [of estoppel] operates to prevent a State contesting before the Court a situation contrary to a clear and unequivocal representation previously made by it to another State, either expressly or impliedly, on which representation the other State was, in the circumstances, entitled to rely and in fact did rely, and as a result the other State has been prejudiced or the State making it has secured some benefit or advantage for itself."

⁵¹⁹ See *Pope & Talbot Inc. v. The Government of Canada*, NAFTA chapter 11/UNCITRAL Arbitration, Interim Award, 26 June 2000, § 111: "The essentials of estoppel are (1) a statement of fact which is clear and unambiguous; (2) this statement must be voluntary, unconditional, and authorized; and (3) there

literature in the field of international law.⁵²⁰ International courts and tribunals have rejected arguments of estoppel where the party invoking estoppel has not even alleged⁵²¹ or proved⁵²² that it relied to its detriment on the statements made by a State.

must be reliance in good faith upon the statement either to the detriment of the party so relying on the statement or to the advantage of the party making the statement." Original English text: "the essentials of estoppel are (1) a statement of fact which is clear and unambiguous; (2) this statement must be voluntary, unconditional, and authorized; and (3) there must be reliance in good faith upon the statement either to the detriment of the party so relying on the statement or to the advantage of the party making the statement." See also *Ceskoslovenska Obchodni Banka, A.S. v. The Slovak Republic*, ICSID Case no. ARB/97/4, Decision of the Tribunal on Jurisdiction, 24 May 1999, § 47 ("An essential element of estoppel is that 'there must be reliance in good faith upon the statement either to the detriment of the party so relying on the statement or to the advantage of the party making the statement.'") Original English text: "An essential element of estoppel is that 'there must be reliance in good faith upon the statement either to the detriment of the party so relying on the statement or to the advantage of the party making the statement'." Quoting from Ian Brownlie, *Principles of Public International Law*, p. 641 (4th ed. 1990); *Canfor Corporation v. United States of America, Tembec et al. v. United States of America, and Terminal Forest Products Ltd. v. United States of America*, NAFTA chapter 11/UNCITRAL Arbitration, decision by the Consolidation Tribunal, 7 September 2005, § 168: "Of the essence to the principle of estoppel is detrimental reliance by one party on statements of another party, so that reversal of the position previously taken by the second party would cause serious injustice to the first party." Original English text: "Of the essence to the principle of estoppel is detrimental reliance by one party on statements of another party, so that reversal of the position previously taken by the second party would cause serious injustice to the first party."

⁵²⁰ See James Crawford, *Brownlie's Principles of Public International Law*, 8th ed. 2012, p. 420: "The essence of estoppel is the element of conduct which causes the other party, in reliance on such conduct, detrimentally to change its position or to suffer some prejudice". Original English text: "The essence of estoppel is the element of conduct which causes the other party, in reliance on such conduct, detrimentally to change its position or to suffer some prejudice." Ian Brownlie, *Principles of Public International Law*, p. 646 (5th ed. 1998) (same); Thomas Cottier and Jörg Paul Müller, *Estoppel*, § 1 (April 2007), in: *The Max Planck Encyclopedia of Public International Law*, available at <http://opil.ouplaw.com/view/10.1093/law:epil/9780199231690/law-9780199231690e1401?rskey=9ryvwd&result=1&prd=EPIL>. Bin Cheng, *General Principles of Law as Applied by International Courts and Tribunals* 143-144 (1987) concluding from international cases that the principle of estoppel in the international sphere: "precludes person A from averring a particular state of things against person B if A had previously, by words or conduct, unambiguously represented to B the existence of a different state of things, and if, on the faith of that representation, B had so altered his position that the establishment of the truth would injure him." (Original English text: "precludes person A from averring a particular state of things against person B if A had previously, by words or conduct, unambiguously represented to B the existence of a different state of things, and if, on the faith of that representation, B had so altered his position that the establishment of the truth would injure him.").

⁵²¹ See *Ceskoslovenska Obchodni Banka, A.S. v. The Slovak Republic*, ICSID Case no. ARB/97/4, Decision of the Tribunal on jurisdiction, 24 May 1999, § 47: "Claimant nowhere alleges that it was misled by Respondent or that it relied on any allegedly misleading statements by Respondent and that it was prejudiced as a consequence of such reliance." (Original English text: "Claimant nowhere alleges that it was misled by Respondent or that it relied on any allegedly misleading statements by Respondent and that it was prejudiced as a consequence of such reliance." *Abraham Rahman Golshani v. The Government of the Islamic Republic of Iran*, Award No. 546-812-3, 2 March 1993, 29 Iran-U.S. Claims Tribunal Reports 78, § 40 (in which the claimant's estoppel argument was rejected); *id.*, Separate Opinion of Judge Aghahosseinin, Part One, § 3.13.1: "Under the doctrine [of estoppel], a party who invokes the rule must show that he has relied upon the statements or conduct of the other party, either to his own detriment or to the other's advantage. Yet in here, there is no suggestion that any such detriment is caused, or any such advantage is gained". (Original English text: "under the doctrine [of estoppel], a party who invokes the rule must show that he has relied upon the statements or conduct of the other party, either to his own

362. Conclusion: As the Tribunal rightly established, HVY have not met the requirements for a successful reliance on the doctrine of estoppel.

(d)(iv)(ii) *Acquiescence*

363. Acquiescence is “equivalent to tacit recognition manifested by unilateral conduct which the other party may interpret as consent.”⁵²³ As Professor Nolte explains, “[s]uch tacit recognition requires one or more specific points of reference, that is: acts or statements by the other party which articulate ‘a right’ (or position) with respect to which there is a

detriment or to the other's advantage. Yet in here, there is no suggestion that any such detriment is caused, or any such advantage is gained”)

⁵²² Professor Nolte's 2017 Expert Opinion (**Exhibit RF-D2**), §§ 18 et seq. See *Case Concerning the Payment of Various Serbian Loans Issued in France (France/Serbia)*, Ruling no. 14 dated 12 July 1929, P.C.I.J. Series A, Nos. 20/21, p. 5, p. 39: “(...) when the requirements of the principle of estoppel to establish a loss of right are considered, it is quite clear that no sufficient basis has been shown for applying this principle in this case. There has been no clear and unequivocal representation by the bondholders upon which the debtor State was entitled to rely and has relied. There has been no change in position on the part of the debtor State. The Serbian debt remains as it was originally incurred; the only action taken by the debtor State has been to pay less than the amount owing under the terms of the loan contracts”(Original English text: “(...) when the requirements of the principle of estoppel to establish a loss of right are considered, it is quite clear that no sufficient basis has been shown for applying this principle in this case. There has been no clear and unequivocal representation by the bondholders upon which the debtor State was entitled to rely and has relied. There has been no change in position on the part of the debtor State. The Serbian debt remains as it was originally incurred; the only action taken by the debtor State has been to pay less than the amount owing under the terms of the loan contracts.”). *North Sea Continental Shelf Cases (Federal Republic of Germany/Denmark; Federal Republic of Germany/Netherlands)*, Judgment of 20 February 1969, I.C.J. Reports 1969, p. 3, p. 26, § 30: “(...) it appears to the Court that only the existence of a situation of estoppel could suffice to lend substance to this contention,—that is to say if the Federal Republic were now precluded from denying the applicability of the conventional régime, by reason of past conduct, declarations, etc., which not only clearly and consistently evinced acceptance of that régime, but also had caused Denmark or the Netherlands, in reliance on such conduct, detrimentally to change position or suffer some prejudice. Of this there is no evidence whatever in the present case.” (Original English text: “(...) it appears to the Court that only the existence of a situation of estoppel could suffice to lend substance to this contention,—that is to say if the Federal Republic were now precluded from denying the applicability of the conventional régime, by reason of past conduct, declarations, etc., which not only clearly and consistently evinced acceptance of that régime, but also had caused Denmark or the Netherlands, in reliance on such conduct, detrimentally to change position or suffer some prejudice. Of this there is no evidence whatever in the present case.”). See also *Philippe Gruslin v. Malaysia*, ICSID Case no. ARB/99/3, Award of 27 November 2000, §§ 20.3-20.5: “In particular, the Claimant has not established that he acted to his detriment in reliance upon any representation which might be constructed out of the failure of the Respondent to plead the approved project issue at an appropriate time. (...) For these reasons the Tribunal rejects the Claimant’s argument that the Respondent is estopped from raising the approved project issue.” (Original English text: “In particular, the Claimant has not established that he acted to his detriment in reliance upon any representation which might be constructed out of the failure of the Respondent to plead the approved project issue at an appropriate time. (...) For these reasons the Tribunal rejects the Claimant’s argument that the Respondent is estopped from raising the approved project issue.”)

⁵²³ Original English text: “equivalent to tacit recognition manifested by unilateral conduct which the other party may interpret as consent.” *Delimitation of the Maritime Boundary in the Gulf of Maine Area (Canada/United States of America)*, Judgment of 12 October 1984, I.C.J. Reports 1984, p. 246, p. 305, § 130.

‘[f]ailure to protest in circumstances when protest is necessary according to the general practice of States in order to assert, preserve or to safeguard’ it.”⁵²⁴ For acquiescence to exist, there must first be a conduct that is susceptible to being tacitly recognized by the Russian Federation. Such recognition must be “sufficiently clear, sustained and consistent to constitute acquiescence.”⁵²⁵

364. HVY have not shown the existence of any conduct that the Russian Federation could have “recognized”.⁵²⁶ In particular, prior to the Arbitrations, the Russian Federation was never before confronted with HVY’s self-serving interpretation of the limitation clause in Article 45(1) ECT. The Russian Federation thus had no earlier occasion to “recognize,” or to protest against, that interpretation.⁵²⁷ There have been no other arbitrations in which the Russian Federation “tacitly” conveyed that it provisionally applied Article 26 ECT. Any

⁵²⁴ Original English text: “[s]uch tacit recognition requires one or more specific points of reference, that is: acts or statements by the other party which articulate ‘a right’ (or position) with respect to which there is a ‘[f]ailure to protest in circumstances when protest is necessary according to the general practice of States in order to assert, preserve or to safeguard’ it.” Professor Nolte’s 2017 Expert Opinion (**Exhibit RF-D2**), § 18 (in which the Separate Opinion of Vice-President Alfaro is quoted, *Case concerning the Temple of Preah Vehear (Cambodia v. Thailand)*, Merits, Ruling of 15 June 1962, I.C.J. Reports 1962, p. 39, p. 40).

⁵²⁵ Original English text: “sufficiently clear, sustained and consistent to constitute acquiescence.” *Delimitation of the Maritime Boundary in the Gulf of Maine Area (Canada/United States of America)*, Judgment of 12 October 1984, I.C.J. Reports 1984, p. 246, p. 309, §§ 145 -146. In that case, Canada has argued that by not reacting to Canada’s issue of licences for the exploitation of hydrocarbon in a certain area of the continental shelf in the Gulf of Maine, the United States recognized that this area falls under the jurisdiction of Canada (§ 138). The ICJ found that “the conduct of the United States, because of its unclear nature, does not satisfy the conditions ... for acquiescence.” (Original English text: “the conduct of the United States, because of its unclear nature, does not satisfy the conditions ... for acquiescence.” (§ 145).

⁵²⁶ See Professor Nolte’s 2017 Expert Opinion (**Exhibit RF-D2**), §§ 20 et seq. Professor Nolte also explains that the Russian Federation has not asserted that the “acquiescing” parties were ought to respond.

⁵²⁷ In support of their acquiescence argument, HVY rely on the Anglo-Norwegian *Fisheries* case, where the ICJ found that Norway had applied its system of delimitation consistently and uninterruptedly over more than 60 years and that general toleration of that Norwegian practice was an unchallenged fact, which, combined with other factors, precluded the United Kingdom from challenging that system of delimitation. SoA, § 212 (*Fisheries Case (United Kingdom v. Norway)*), Judgment of 18 December 1951, I.C.J. Reports 1951, p. 116, pp. 138-139). Borrowing the words of the ICJ in the *Gulf of Maine* case: “the elements of fact and of law in the Fisheries case and those in the present dispute are clearly too dissimilar for a comparison thereof to produce legal consequences valid for the present case. Neither the long duration of the Norwegian practice (70 years), nor Norway’s activities in manifestation of that practice, warrant the drawing of conclusions from the 1951 Judgment that would be relevant in the present case.” Original English text: “the elements of fact and of law in the Fisheries case and those in the present dispute are clearly too dissimilar for a comparison thereof to produce legal consequences valid for the present case. Neither the long duration of the Norwegian practice (70 years), nor Norway’s activities in manifestation of that practice, warrant the drawing of conclusions from the 1951 Judgment that would be relevant in the present case.” *Delimitation of the Maritime Boundary in the Gulf of Maine Area (Canada/United States of America)*, Judgment of 12 October 1984, I.C.J. Reports 1984, p. 246, p. 309, § 144.

reliance on acquiescence therefore fails because HVY have not shown how, prior to the Arbitrations, the Russian Federation was ever placed in a situation that called for the Russian Federation's objection with respect to the provisional application to Article 26 ECT.⁵²⁸

(e) ***The District Court correctly ruled that the pacta sunt servanda principle is not violated (ground 5.19)***

365. HVY believe that the so-called *pacta sunt servanda* principle is relevant.⁵²⁹ They endorse the Tribunal's ruling, which apparently entails that this principle would be violated if the Russian Federation were to rely on its national legislation:

“Under the *pacta sunt servanda* rule in Article 27 of the VCLT, a State is prohibited from invoking its internal legislation as a justification for failure to perform a treaty. In the Tribunal's opinion, this cardinal principle of international law strongly militates against an interpretation of Article 45(1) that would open the door for a signatory, whose domestic regime recognizes the concept of provisional application, to avoid the provisional application of treaty (to which it has agreed) on the basis that one or more provisions of the treaty is contrary to its internal law.”⁵³⁰

366. The Russian Federation agrees that any treaty that has entered into force should be implemented in good faith (*pacta sunt servanda*). This follows from, *inter alia*, Articles 26 and 27 VCLT:

“Article 26. ‘Pacta sunt servanda’

Every treaty in force is binding upon the parties and must be performed by them in good faith.

Article 27. Internal law and observance of treaties

A party may not invoke the provisions of its internal law as justification for its failure to perform a treaty. This rule is without prejudice to article 46.”

⁵²⁸ Professor Nolte's 2017 Expert Opinion (**Exhibit RF-D2**), §§ 20-29.

⁵²⁹ SoD, §§ II.171-172, SoA, §§ 236, 644-646.

⁵³⁰ HEL Interim Award, marginal 313, original English text: “[u]nder the *pacta sunt servanda* rule in Article 27 of the VCLT, a State is prohibited from invoking its internal legislation as a justification for failure to perform a treaty. In the Tribunal's opinion, this cardinal principle of international law strongly militates against an interpretation of Article 45(1) that would open the door to a signatory, whose domestic regime recognizes the concept of provisional application, to avoid the provisional application of treaty (to which it has agreed) on the basis that one or more provisions of the treaty is contrary to its internal law.”

367. However, as explained previously⁵³¹, the Tribunal's ruling is untenable. The Tribunal fails to recognise that the scope and contents of the *pactum* are limited in this case under Article 45 ECT. As Article 45 ECT prevents the Treaty from creating any obligations that are incompatible with national law. The District Court therefore correctly ruled that the *pacta sunt servanda* principle is not violated:

“5.19 (...) In other words: a state that relies on a conflict between a treaty provision and national law, on sound grounds and referencing the Limitation Clause, does not act contrary to the *pacta sunt servanda* principle, nor to the principle of Article 27 VCLT. As was considered by the Tribunal and is relevant in this case, the fact that the invocation of a provision of national law can lead to a discussion about the meaning of the contents of said provision and thus result in uncertainty in international matters, does not affect this.”

368. The District Court's ruling corresponds with the established (since before 1994) and generally accepted principles of international law.⁵³² Provisions such as Article 45 (1) ECT

⁵³¹ See the Russian Federation's position in the arbitration proceedings in the (Hulley) Second Memorial on Jurisdiction, §§ 125 et seq. See also Writ, §§ 150 et seq., and SoR, §§ 132 et seq.

⁵³² See (Hulley) Second Memorial on Jurisdiction, §§ 128 et seq. See also the Harvard Draft Convention on the Law of Treaties (1938) and the explanation thereto. Harvard Law School, Law of Treaties, Draft Convention on the Law of Treaties and Commentary, 29 AM.J.INT'L L., Supplement 653, 1029-1030 (1935) (R-380). "Article 23. Excuses for Failure to Perform. Unless otherwise provided in the treaty itself, a State cannot justify its failure to perform its obligations under a treaty because of any provisions or omissions in its municipal law, or because of any special features of its governmental organization or its constitutional system." "The phrase 'unless otherwise provided in the treaty itself' is intended to exclude the application of this article to treaties which by their own terms expressly provide that the parties shall not be bound to perform the obligations stipulated therein in the event they are prevented from so doing by existing or subsequently enacted provisions in their municipal law, because of absence of such provisions, or because of special features in their governmental or constitutional system." (emphasis added). (Original English text: "Article 23: Excuses for Failure to Perform. Unless otherwise provided in the treaty itself, a State cannot justify its failure to perform its obligations under a treaty because of any provisions or omissions in its municipal law, or because of any special features of its governmental organization or its constitutional system." "The phrase 'unless otherwise provided in the treaty itself' is intended to exclude the application of this article to treaties which by their own terms expressly provide that the parties shall not be bound to perform the obligations stipulated therein in the event they are prevented from so doing by existing or subsequently enacted provisions in their municipal law, because of absence of such provisions, or because of special features in their governmental or constitutional system." (emphasis added). James Fawcett, "The Legal Character of International Agreements", 50 BYIL 381, pp. 390-91 (1953) (R-396): "Certain provisions in international agreements appear to negative any intention to create legal relations. These are provisions which in one way or another leave it to the parties themselves to determine the extent to the obligations they have assumed and the mode of performance. For example, an undertaking qualified by the words 'subject to the law in force' would, if submitted, create no international obligation at all; for it would enable any party to appeal successfully to municipal law against any attempt by another party to enforce the obligation." (emphasis added). Original English text: "Certain provisions in international agreements appear to negative any intention to create legal relations. These are provisions which in one way or another leave it to the parties themselves to determine the extent to the obligations they have assumed and the mode of performance. For example, an undertaking qualified by the words 'subject to the law in force' would, if submitted, create no international obligation at all; for it would enable any party to appeal successfully to municipal law against any attempt by another party to enforce the obligation." (emphasis added)

occur in several Treaties (see §§ 52-58 above) as States can limit the scope of treaty obligations. To this end, they are free to make reference to national law. For instance, Sondaal wrote in 1986 that provisional application requires the implementation of treaty provisions unless the treaty itself explicitly limits the provisional application:

“Provisional application requires the implementation of the treaty provisions, unless this application is explicitly limited, such as the limitation that provisional application extends only to what is possible under national and constitutional law.”⁵³³ (emphasis added)

369. The freedom of States to shape treaty obligations themselves means that they can agree to have the scope of such treaty obligations determined, at least in part, by national law.⁵³⁴ Therefore, a reliance on a provision such as Article 45 ECT does not in any way mean that a State acts contrary to the *pacta sunt servanda* principle. This is also generally assumed in legal literature:

(a) Prof. Gazzini writes that Article 45 ECT is in no way contrary to Article 27 VCLT:

“The domestic clause in Article 45 (1) is in no way in contradiction with Article 27 VCLT as it expressly makes the provisional application of the treaty dependent on its compatibility with the domestic laws of signatories.”⁵³⁵ (emphasis added)

⁵³³ H.H.M. Sondaal, *De Nederlandse Verdragspraktijk* (diss.) Den Haag: T.M.C. Asser Instituut, 1986, p. 58.

⁵³⁴ The Tribunal appears to admit this. See HEL Interim Award, marginal 315, particularly the wording *“unless the language of the treaty is clear and admits no other interpretation”*. The UN General Assembly endorsed this wording in International Law Commission, Sixty-seventh session, J.M. Gomez-Robledo, Special Rapporteur, Third report on the provisional application of treaties, p. 14, publicly available via: <http://legal.un.org/docs/?symbol=A/CN.4/687>: “66. *The Special Rapporteur wishes to stress that in the Interim Award on Jurisdiction and Admissibility in the Yukos case, the tribunal recognized that a treaty must not allow domestic law to determine the content of an international legal obligation ‘unless the language of the treaty is clear and admits no other interpretation’, which reaffirms that States have absolute freedom to negotiate the terms of a treaty and, hence, its provisional application.*” (emphasis added). Original English text: “66. *The Special Rapporteur wishes to stress that in the Interim Award on Jurisdiction and Admissibility in the Yukos case, the tribunal recognized that a treaty must not allow domestic law to determine the content of an international legal obligation ‘unless the language of the treaty is clear and admits no other interpretation’, which reaffirms that States have absolute freedom to negotiate the terms of a treaty and, hence, its provisional application.*” (emphasis added).

⁵³⁵ T. Gazzini, “Provisional Application of the Energy Charter Treaty: A Short Analysis of Article 45”, *Transnational Dispute Management* 2010 Volume 7(1), pp. 1-17, pp. 10-11 (**Exhibit RF-273**). Original English text: “*The domestic clause in Article 45 (1) is in no way in contradiction with Article 27 VCLT as it expressly makes the provisional application of the treaty dependent on its compatibility with the domestic laws of signatories.*”

- (b) Messrs. De Gramont and Alban write that Article 45 ECT sets aside the principle that States may not invoke their national laws:

“Article 27 of the Vienna Convention provides explicitly: “a party may not invoke the provisions of its internal law as justification for its failure to perform a treaty. Article 45 [ECT] seems to set that principle aside.”⁵³⁶

- (c) The authors Polkinghorn and Gouiffès believe that Article 45 ECT “*practically*” takes priority over the principle that States may not invoke their national laws:

“Such limiting provisions have legal effect at both international and national levels. Practically, Article 45(1) of the ECT takes priority over Article 27 of the Vienna Convention and the principle of international law prohibiting states from raising internal law as justification for their failure to comply with their international commitments.” (emphasis added)⁵³⁷

- (d) Dr Pritzkow believes that common provisions such as Article 45 ECT result in a reversal (“*Umkehrung*”) of the main rule of Article 27 VCLT.⁵³⁸

370. As evident from the above, HVY’s assertion that the interpretation of the District Court is supposedly incompatible with the principles of international law contained in Articles 26 and 27 VCLT holds no water.⁵³⁹

⁵³⁶ A. de Gramont and E.M. Alban, "The sun never sets: provisional application and the Energy Charter Treaty" in Graham Coop (ed.) *Energy Dispute Resolution: Investment Protection, Transit and the Energy Charter Treaty*, 2011, pp. 211-248 (Exhibit **RF-291**) p. 219. Original English text: "Article 27 of the Vienna Convention specifically provides that 'a party may not invoke the provisions of its internal law to avoid its international treaty obligations.' Article 45(1) seems to set that principle aside."

⁵³⁷ Michael Polkinghorn and Laurent Gouiffès, "Provisional application of the Energy Charter Treaty: the conundrum" in Graham Coop (ed.) *Energy Dispute Resolution: Investment Protection, Transit and the Energy Charter Treaty*, 2011, pp. 249-282 (**Exhibit RF-227**), p. 259. Original English text: "Such limiting provisions have legal effect at both international and national levels. Practically, Article 45(1) of the ECT takes priority over Article 27 of the Vienna Convention and the principle of international law prohibiting states from raising internal law as justification for their failure to comply with their international commitments. In other words, Article 45(1) of the ECT arguably gives national law priority over the ECT when applied provisionally."

⁵³⁸ S. Pritzkow, *Das völkerrechtliche Verhältnis zwischen der EU und Russland im Energiesektor*, Springer, 2011, pp. 62 et seq., (**Exhibit RF-230**).

⁵³⁹ See also the positions previously taken in the Arbitrations. For instance, compare Lukashu’s short expert opinion, "Opinion on Provisional Application of the Energy Charter Treaty" (submitted in the Arbitrations, **RF-03.1.C-1.3.5**). In one of the expert opinions submitted by HVY, Lukashuk was designated as an "eminent" and "leading authority in the field" (Gladyshev Opinion (HVY), § 38). Professor Pellet's 2017 Expert Opinion (**Exhibit RF-D3**), § 38.

- (f) *HVY's interpretation of the words "not inconsistent" is untenable (new argument)*

The Russian Federation refers to:		
Arbitrations:		
HEL Interim Award	-	-
Setting aside proceedings:		
Writ	Chapter IV.C.b	§§ 137-173
SoD	Part II, Chapter 2.1.3	§ 238
SoR	Chapter III.C.d	§ 111
SoRej	Chapter 2.2.3	§§ 79-81
RF Pleading Notes	-	-
HVY Pleading Notes	-	-
SoA	Chapter 4.5.2	§§ 375-407, 652-653

Primary exhibits:	
Arbitrations:	
-	-
Setting aside proceedings:	
RF-272	<i>Travaux préparatoires</i> , which demonstrates that the scope of the words "not inconsistent" was interpreted broadly at the time of the negotiations

Essence of the reasoning

Article 45(1) ECT does not require *undeniable* inconsistency.

- HVY's position regarding the words "not inconsistent" in Article 45(1) ECT changes continuously throughout the proceedings (see subsection (f)(i)). The new positions adopted are too late and irrelevant for the assessment (subsection (f)(ii)).
- The interpretation of the words "not inconsistent" first proposed by HVY on appeal is a substantial reformulation whereby the words "is not inconsistent with" are replaced with "is not explicitly forbidden". However, Article 45 ECT does not require an explicit prohibition, let alone a prohibition that would be specifically tailored to Article 26 ECT (subsection (f)(iii)).
- The ordinary meaning of the terms in Article 45 ECT implies that no international obligation to apply the Treaty provisionally is created if it is inconsistent with national laws and regulations. Nothing indicates that – as HVY argue – there must be an undeniable inconsistency with specific prohibitory or mandatory provisions (subsection (f)(iii)).
- The development history and state practice provide no basis whatsoever for the assertion that Article 45 ECT requires an undeniable inconsistency (subsection

(f)(iv)).

(f)(i) *Introduction: HVY's continuously changing positions on the words "not inconsistent"*

371. In the Arbitrations, the parties extensively debated the interpretation of Article 45 ECT. The positions taken by HVY at the time are demonstrated in particular by the statements they submitted in the jurisdiction phase: the *Counter-Memorial on Jurisdiction* and the *Rejoinder on Jurisdiction*. To substantiate their extensively explained statements, HVY also submitted expert opinions. Nevertheless, HVY and their experts spent not a single paragraph on the interpretation of the words "*not inconsistent*".⁵⁴⁰ In the Arbitrations, there was no debate in other respects either about the interpretation of those words.
372. In the first instance, HVY casually took new positions in a new paragraph that seem to be related to the interpretation of the words "*not inconsistent*". HVY argued that a reliance on Article 45 ECT requires the Russian Federation to designate a specific and explicit prohibitory provision that prohibits "*arbitration between the State and a foreign investor pursuant to Article 26 ECT.*"⁵⁴¹ Apparently, HVY suddenly believed in the first instance that Article 26 ECT can be inconsistent with national law only if a explicit prohibitory provision can be designated between foreign investors and the State, stating that arbitration is categorically prohibited.⁵⁴²
373. HVY appear to have abandoned this position on appeal. On appeal, HVY discussed the interpretation of the words "*not inconsistent*" for the first time in a (sub)section, containing

⁵⁴⁰ Such an argument cannot be found in the procedural documents (for example, see Hulley Counter Memorial on Jurisdiction, §§ 203-209, Hulley Rejoinder on Jurisdiction §§ 110-132). See also HEL Interim Award, marginal nos. 290-300, where HVY's position on the interpretation of Article 45 ECT is summarised. None of the experts, i.e. Crawford, Reisman of Gladyshev, engaged by HVY at that time dedicated a section or even just a subsection to the interpretation of the words "*not inconsistent*". None of them conclude in their conclusions that a reliance on Article 45 ECT requires the Russian Federation to designate specific prohibitory provisions.

⁵⁴¹ See the casual suggestion in SoD § II.238 and the further elaboration in SoRej. §§ 79-81: "79. *If it is assumed that the district court would follow the interpretation of Article 45 ECT that is advocated by the Russian Federation, then the Russian Federation must subsequently demonstrate that there is inconsistency between the arbitration clause of Article 26 ECT on the one hand and a specific provision of Russian law on the other hand. Any other inconsistency cannot result in the Russian Federation escaping provisional application (...) 81. In order to demonstrate that Article 26 ECT is inconsistent with Russian law, the Russian Federation will therefore have to refer to an explicit provision in Russian law that expressly prohibits arbitration between a foreign investor and the State on a violation of substantive treaty provisions by the State.*"

⁵⁴² See, *inter alia*, SoRej. §§ 81-87, 116 and 123.

multiple entirely new statements and arguments that were neither adopted in the Arbitrations nor in the first instance.⁵⁴³ They now argue that there must be an undeniable "inconsistency". To this end, they emphasise in particular the double denial in the English text of Article 45(1) ECT.

(f)(ii) The new positions taken on the interpretation of the words "not inconsistent" are late and irrelevant

374. In essence, HVY assert that the interpretation of Article 45(1) ECT by the Tribunal is not complete, or at least not entirely correct. HVY now plead for an entirely new interpretation of Article 45(1) ECT, which the Tribunal (rightfully) never formed an opinion on. A defendant is not permitted to plead for an entirely new treaty interpretation in the setting aside proceedings. Such a new argument can no longer be discussed; moreover, the right to raise such an argument is forfeited (see §§ 268-277 above).

375. What's more, the Russian Federation points out that the further interpretation of the words "not inconsistent" is irrelevant. The previous chapters demonstrate that, in this case, the provisional application of Article 26 ECT is undeniably inconsistent with Russian law.⁵⁴⁴ Against that background, this Court of Appeal in any event does not have to take a position on whether such an undeniable inconsistency is required at all. However, for the sake of argument, the Russian Federation explains that the statement that an undeniable inconsistency is required does not hold water in any event.

(f)(iii) The District Court correctly ruled that HVY's interpretation of the words "not inconsistent" is too limited (ground 5.33)

376. As explained above, HVY argued in the first instance that a reliance on Article 45 ECT requires the Russian Federation to designate a specific provision that explicitly prohibits "arbitration between the State and a foreign investor pursuant to Article 26 ECT." Of course, the District Court could have left these casual remarks of HVY undiscussed, but it ruled in response thereto that the words "not inconsistent" in Article 45(1) ECT should not be interpreted restrictively:

⁵⁴³ SoA, §§ 375-407 and 652-653.

⁵⁴⁴ For example, see § 195 below and the references there to countless statutory provisions, from which it clearly follows that it is "forbidden" to arbitrate public-law disputes. See also § 249, which refers to an explicit statutory provision that prohibits shareholders from bringing their own legal claim unless the law includes an exceptional provision for this.

“5.33. Against this backdrop, the court will now assess whether the provisional application of the arbitral provision of Article 26 ECT is in accordance with the Russian Constitution, laws or other regulations. In this context, the court states the following first and foremost. In the view of the defendants, a provision of the ECT, such as Article 26, can only be incompatible with Russian law if the Treaty provision concerned is prohibited in national law. They believe that there cannot be incompatibility if Russian law does not expressly provide for the treaty provision concerned. The court holds that the defendants’ interpretation is too limited. Leaving aside the fact that a linguistic interpretation of Article 45 ECT does not yield a basis for such an interpretation, it is also not evident. Given in part the fact that the provisional application finds its legitimacy in the signing (and the sovereignty of the Signatories is at stake in a number of treaty provisions), the provisional application of the arbitral provision contained in Article 26 is also contrary to Russian law if there is no legal basis for such a method of dispute settlement, or – when viewed in a wider perspective – if it does not harmonise with the legal system or is irreconcilable with the starting points and principles that have been laid down in or can be derived from legislation. Whenever the court for the sake of brevity uses ‘compatibility’ of the provisions of the ECT with Russian laws below, the court refers to this interpretation of the term ‘not inconsistent’ in Article 45 paragraph 1 ECT.” (emphasis added)

377. The District Court therefore discussed HVY's position that there is inconsistency with national law only if a specific and explicit prohibitory provision is included in the law. The foregoing demonstrates that the District Court considers that interpretation to be too limited. According to the District Court, Article 26 ECT is also "not inconsistent" with national law within the meaning of Article 45 ECT if resolution of public-law disputes by arbitration is not in keeping with the Russian legal system or is incompatible with the starting points and principles of Russian legislation.⁵⁴⁵ This opinion is correct and substantiated comprehensibly (see also § 487 below).⁵⁴⁶ The “interpretation” proposed by HVY is a substantial reformulation whereby the words "*is not inconsistent with*" are replaced with "*is not explicitly forbidden*". However, Article 45 ECT does not require an explicit prohibition, let alone a prohibition that would be specifically tailored to Article 26 ECT.

⁵⁴⁵ See also §§ 162 (and 111, 150, 157) of the SoR.

⁵⁴⁶ HVY wrongfully complain that the interpretation of the District Court was not substantiated properly and is "*completely wrong*", see SoA, §§ 376, 413.

(f)(iv) *The new positions taken by HVY on the interpretation of the words "not inconsistent" fail*

378. On appeal, HVY – as stated – seem to have abandoned their previous positions. They currently present the completely new assertion that there should be an "*undeniable inconsistency*".⁵⁴⁷ That there must be "*inconsistency*" with national law is correct and is not in dispute. HVY's position that such inconsistency must be "*undeniable*", however, is correct. They add the word "*undeniable*", whereas this word cannot be found in the text of the Treaty.

(f)(iv)(i) *The ordinary meaning of the words "not inconsistent with its constitution, laws or regulations"*

379. According to the general rule of interpretation in Article 31(1) VCLT, a treaty must be interpreted “in good faith in accordance with the ordinary meaning to be given to the terms of the Treaty in their context and in the light of its object and purpose.”⁵⁴⁸ According to the copy of the Oxford Thesaurus, submitted by HVY, the ordinary meaning of the term "inconsistent with" is: "incompatible with", "differing from", "different to" or "not in accord with".⁵⁴⁹ Compare also the words "incompatible", "unvereinbar" and "strijdig" in the French, German and Dutch language versions.⁵⁵⁰

380. HVY argue that the double denial incorporated in the words “*not inconsistent with*” is important.⁵⁵¹ However, such a double denial cannot be found in all language versions. By way of example, see the Dutch translation ("*niet strijdig*") and the comparable choice of words in the (authentic) Russian text of the Treaty ("*не противоречит*").⁵⁵² If the negotiating States would have wanted to set more stringent requirements, in the sense that a

⁵⁴⁷ See the heading of section 4.5.2.

⁵⁴⁸ HVY devote a lot of attention to "*inconsistency under international law*" (SoA, §§ 384-393). Such a uniform and general concept of "*under international law*" does not exist. HVY refer to some statements they have selected which relate to entirely different treaty provisions in other treaties. However interesting these statements may be, they are unimportant in the interpretation of Article 45 ECT on the basis of Article 31 VCLT.

⁵⁴⁹ See Exhibit HVY-174 as also referred to in SoA, § 378.

⁵⁵⁰ The French and German texts are authentic. It does not seem to be disputed that the Dutch translation is correct. See SoA, § 380.

⁵⁵¹ SoA, § 381.

⁵⁵² See also Exhibit HVY-145, Dissenting opinion Prof. Stern, footnote 8.

successful reliance on Article 45 ECT is subject to an undeniable inconsistency with national law, they would have included such words in the text.

381. The meaning of the ordinary words in the Treaty is clear: on the basis of Article 45(1) ECT, no international-law obligations will arise if they are inconsistent with national laws and regulations. Article 45 ECT does not require that there is inconsistency with specific national prohibitory or mandatory provisions.⁵⁵³ Article 45 ECT uses the words "*not inconsistent with its constitution, laws or regulations*". The District Court saw this correctly and (rightly) considered the fact that legislators often work with strict starting points and principles. By now, it has become generally accepted that it is impossible to describe the areas of law exhaustively on the basis of specific mandatory and prohibitory provisions. In the 18th and 19th centuries, there were still some people who thought that it would be possible to enact materially complete legislation. A good example of such codification efforts concerns the *Allgemeine Landrecht für die Preussische Staaten* (1794). This code of law attempted to regulate every possible legal issue up to the smallest detail. There should be a specific statutory provision for every legal issue. Legal historians agree that such attempts at codification have proved unsuccessful.⁵⁵⁴ Modern laws no longer strive for such detailed material completeness. Modern Dutch codifications use open standards, strict legal starting points and general principles, which provide a certain legal methodology. This is no different in the Russian Federation. Accordingly, general principles under constitutional law, such as the principle of separation of powers and the primary authority of the federal legislation, are important in this case. In those cases in which no specific legal provision is available – for example, on the exact scope of the powers of government bodies in the provisional application of treaties – courts may formulate concrete answers on the basis of general legal principles and legal provisions. Of course, it will also be inconsistent with Dutch or Russian laws or regulations if a certain course of action – which is not explicitly prohibited by a specific rule – is contrary to the basic legal system.

⁵⁵³ HVY's view to the contrary in SoA, §§ 384-393, which strongly starts from inconsistency with separate explicit mandatory or prohibitory provisions, is therefore not in accordance with the ordinary meaning of the terms in Article 45 ECT.

⁵⁵⁴ See, for example, J.H.A. Lokin and W.J. Zwolve, *Hoofdstukken uit de Europese Codificatiegeschiedenis*, Kluwer: Deventer 2001, p. 233.

382. In conclusion: the ordinary meaning of the terms in Article 45 ECT implies that no international obligation to apply the treaty provisionally is created if it is *inconsistent* with national laws and regulations. Nothing indicates that there must be an undeniable inconsistency with specific prohibitory or mandatory provisions.

(f)(iv)(ii) *Object and purpose of Article 45(1) ECT*

383. The words “*not inconsistent*” prevent the creation of treaty obligations that would conflict with national laws and regulations.⁵⁵⁵ As explained above, the wording of Article 45(1) ECT aims to ensure that the Treaty is applied provisionally by as many States as possible. In principle, government officials are not authorized under the law – more specifically, the constitution – to deviate from laws without the permission of the Parliament. The text of Article 45(1) ECT provides for an option that allows government leaders to nevertheless sign the Treaty. The words “*not inconsistent*” must be interpreted against that background. The strict interpretation proposed by HVY – which apparently requires more than “ordinary” inconsistency – allegedly affects the purpose of Article 45(1) ECT (see §§ 78 and 138-140 above).

(f)(iv)(iii) *Development history and state practice*

384. The development history and state practice provide no basis whatsoever for the assertion by HVY that Article 45(1) ECT requires an undeniable inconsistency.

385. The scope of the words “*not inconsistent with*” was interpreted broadly at the time of the negotiations. For instance, Mr Clive Jones wrote on 9 November 1994 that it is conceivable that, in some States, new treaty obligations are acceptable only if new laws are passed to that end. According to Mr Clive Jones, such cases are covered by Article 45(1) ECT, even if the treaty obligations are not strictly inconsistent with existing laws:

"Also, it may be the case in a number of countries that new obligations created by the Treaty, even if there were no conflicting laws, could not be accepted until new national laws had been passed to give effect to those obligations.

⁵⁵⁵ See also SoA § 383 in which HVY speak of a “*rule of conflict*”. The Russian Federation assumes they mean that Article 45(1) ECT prevents conflicts between treaty obligations and national laws and regulations. Because Article 45 ECT prevents obligations from arising under international law, there will never be an actual conflict.

Again, this would seem to be covered by the constitutional exception in 45(1) and no declaration would be necessary (...).⁵⁵⁶ (emphasis added)

386. Apparently, the signatories – unlike HVY – did not attribute decisive significance to the “double denial” in the English treaty text. The European Commission, the Council and the twelve member states at the time made a Joint Statement (see §§ 113-117 above). The wording of this Statement is very similar to that of the District Court in ground 5.33 of the Judgment (“*does not harmonise with the legal system or is irreconcilable with the starting points and principles that (...) can be derived from legislation*”). In this declaration of the Council, the word “compatible” is used as a synonym for the words “not inconsistent”:

“The Council, the Commission and the Member States agree on the following declaration: (...) Article 45(1) (...) does not create any commitment beyond what is compatible with the existing internal legal order of the Signatories (...).”⁵⁵⁷ (emphasis added)

- (g) ***HVY’s arguments regarding the broad powers of President Yeltsin fail (new argument)***

The Russian Federation refers to:		
Arbitrations:		
HEL Interim Award		
Setting aside proceedings:		
Writ		
SoD		
SoR		
SoRej		
RF Pleading Notes		
HVY Pleading Notes		
SoA	Part I, Chapter 5.3	§§ 449-490

Primary exhibits:	
Arbitrations:	
Setting aside proceedings:	
	Avtonomov Expert Opinion
	Marochkin Expert Opinion

⁵⁵⁶ Original English text: “Also, it may be the case in a number of countries that new obligations created by the Treaty, even if there were no conflicting laws, could not be accepted until new national laws had been passed to give effect to those obligations. Again, this would seem to be covered by the constitutional exception in 45(1) and no declaration would be necessary (...)” (emphasis added). Fax from Clive Jones to Lise Weis and Craig Bamberger, among others, dated 9 November 1994, Re: draft provisional application (**Exhibit RF-272**).

⁵⁵⁷ 1994 Joint EC Statement, (R-352). Original English text: “The Council, the Commission and the Member States agree on the following declaration: (...) Article 45(1) (...) does not create any commitment beyond what is compatible with the existing internal legal order of the Signatories (...)”(emphasis added)

Essence of the reasoning

HVY's arguments regarding the alleged broad powers of President Yeltsin are irrelevant, late and moreover wrong.

- The entirely new assertions and arguments regarding the powers of the Russian President under the 1993 Constitution are not credible and contrary to their previous positions.
- These new assertions regarding the powers of President Yeltsin in these setting aside proceedings are impermissible (section (g)(ii)).
- The assertions on the allegedly dominant role of the Russian President which supposedly mean that he may apply treaties provisionally without any limitations are irrelevant. The President played no part in the formation and signing of the ECT. It was exclusively the government who proceeded to sign the ECT (section (g)(ii)).
- The 1993 Constitution starts from the principle of the separation of powers. The powers of the Russian President are limited not only under the 1993 Constitution but also in constitutional practice. For instance, the President is not authorised to provisionally bind the Russian Federation to treaties independently without any limitation (section (g)(iii)).
- It follows from the Russian Constitution, federal laws and established case law that only treaties approved by the Parliament prevail over federal laws (section (g)(iv)).
- The consistent treaty practice of the Russian Federation shows that arbitration schemes such as Article 26 ECT, based on which private parties may submit investment disputes with the state to arbitrators, are never applied provisionally (section (g)(vi)).

(g)(i) Introduction

387. The Russian Federation has advanced three independent arguments to explain that Article 26 ECT is inconsistent with Russian law and as a result thereof does not have to be applied provisionally (see § 149 above). One of these arguments is that arbitration on the basis of Article 26 ECT is inconsistent with the Russian Constitution (see §§ 155 et seq. above). The District Court agreed to this and to that end extensively discussed the principles of the separation of the powers under Russian law.

388. In these appeal proceedings, HVY present an entirely new argument which they derive from the Russian Constitution that took effect in 1993.⁵⁵⁸ They argue that, according to this Constitution, the President has "*the primary authority*".⁵⁵⁹ They argue that the 1993 Constitution places the President of the Russian Federation "*above the three state powers*".⁵⁶⁰ The 1993 Constitution allegedly provides for a form of separation of powers that is "*in fact far removed from a strict trias politica form*".⁵⁶¹ From their position that the 1993 Constitution introduced a "*super-presidential democracy*",⁵⁶² they ultimately derive the conclusion that the President is authorised – on the basis of the 1993 Constitution – to provisionally bind the Russian Federation to treaties independently and without any limitation.⁵⁶³ This position is elaborated on the basis of expert opinions by two new experts. This new position is the main topic of multiple chapters of the Statement of Appeal.⁵⁶⁴
389. In the following sections, the Russian Federation sets out that these new arguments are incompatible with previous positions (see § 390 et. seq. below). This position, which was not raised by HVY during the Arbitrations, is neither credible nor relevant. Accordingly, these new arguments can no longer be discussed in these setting aside proceedings (see §§ 390 et seq. below). Subsequently, the substance of the 1993 Constitution will – for the sake of argument – be discussed and it will be explained that HVY's arguments are incorrect (see §§ 397 et seq. below).

(g)(ii) *The completely new statements about the 1993 Constitution are implausible, contrary to any previously adopted positions, irrelevant and inadmissible in these setting aside proceedings*

390. In the first instance, HVY emphasised that all relevant subjects were "*fully*" discussed in the Arbitrations and that all mutual arguments were analysed "*in-depth*" and

⁵⁵⁸ See, in particular, SoA §§ 449-490.

⁵⁵⁹ SoA, § 94.

⁵⁶⁰ SoA, § 72.

⁵⁶¹ SoA, § 496.

⁵⁶² SoA, § 88.

⁵⁶³ See, in particular, SoA §§ 449-490.

⁵⁶⁴ They are prominently addressed in chapters 2.2 and 5.5, among others.

"methodically".⁵⁶⁵ HVY indeed discussed the powers of the Russian government to apply a treaty provisionally in detail. They elaborated their arguments particularly in the Counter-Memorial on Jurisdiction and the Rejoinder on Jurisdiction. In addition, HVY relied on two opinions written by their Russian lawyer, Mr Gladyshev. Mr Gladyshev was also heard as a witness at the hearing during the Arbitrations.⁵⁶⁶

391. The thoroughness of Mr Gladyshev's analysis is also apparent from his invoice. Gladyshev charged USD 1.269.662,80 for his activities in the Arbitrations.⁵⁶⁷ In his written opinion, Gladyshev nevertheless devoted no further attention to the 1993 Constitution. Gladyshev believed that Article 23 FLIT – a special arrangement that, according to Gladyshev, applied retroactively – is especially important. At the hearing, Gladyshev formulated his arguments as follows:

A. [...] So, when we are talking about the separation of power in Russia, we are not talking about a free-standing regime of the Constitution, we are talking about the whole gambit of laws that would specify how this works. And in the area of the international treaties, it works in accordance with the Law of International Treaties. And as I have pointed out, the Russian Federation, in Article 23 of this law, went to a great pain to make the regime of the provisional application fit smoothly into the whole fabric of the Russian Constitution arrangement, including the division of powers.

I have pointed out Article 1 of the Russian Law on International Treaties includes this regime backwards, to all the treaties that were concluded in the time of the Soviet Union.

(...) Q. (...) Okay, you agree that the Russian Constitution provides for the separation of powers, but that in the context of the treaties you nonetheless hold the view that the executive power, which signs treaties, provides for the provisional application of treaties that are therefore allegedly binding on the Russian state, irrespective of whether or not the treaty must be ratified, or, if

⁵⁶⁵ See SoD, § I.26, see also the preceding SoD, § I.25: "*The purpose of these attachments is to provide the District Court with insight into the unrivalled scale of these Arbitrations. They show that during a period of slightly less than ten years of conducting proceedings, the parties attended five procedural sessions that lasted more than six days, in addition to a session on jurisdiction and inadmissibility that lasted ten days and a session on the merits of the case that lasted 21 days, which jointly resulted in a court record of more than 7,000 pages. In addition, approximately 32 statements and instruments were submitted, accompanied by 6,000 factual and legal exhibits, nine witness statements and 44 expert opinions, and documents comprising thousands of pages were exchanged.*"

⁵⁶⁶ Hearing transcript dated 20 November 2008, pp. 62 et seq.

⁵⁶⁷ This is apparent from the final statement at the end of the Final Awards. Apparently, Gladyshev applied a low hourly rate: Hearing transcript dated 20 November 2008, p. 23 "*My fee in this matter is very modest.*" Based on his hourly rate, he must have worked on this case for at least 5,000 hours (!). In short: Gladyshev worked on his investigation for three years on a fulltime basis.

ratification is required, then this must be done by the legislative power; is that your view?

A. No, sir, this is not my view at all. Let me explain it.

First, my view is that Article 11, paragraph 3, is to be read in conjunction with Article 10, and it specifically refers to the fact that when you want to understand how the division of powers, separation of powers, works under the Russian legal system, the Constitution is not the end of the story. This is a very specific article, it is not always this way in the Constitution, but this article refers you to the laws. The separation of powers, which not surprisingly is not the -- the powers are not separated by a Berlin wall. They have to coordinate their work and to communicate with one another. And the precise way they do that is in a way that is prescribed by the federal law." (emphasis added)⁵⁶⁸

392. In the Arbitrations, the Russian Federation explained at length that the new Constitution of 1993 provided for the separation of powers.⁵⁶⁹ This argument was not disputed by HVY at the time. Gladyshev's extensive expert opinion dated 29 June 2006 and the procedural documents drawn up by HVY themselves do not contain even a single section that explains how the 1993 Constitution introduced a "*super-presidential democracy*"⁵⁷⁰ and how this supposedly allows the President or the government to provisionally apply treaties without any limitations. Apparently, Gladyshev – who, as said, would have conducted a very thorough investigation – considered such argumentation irrelevant or incorrect.

⁵⁶⁸ In this context, see hearing transcript dated 20 November 2008, pp. 68-72 (original English text): "A. (...) So when we are talking about the separation of power in Russia, we are not talking of a free-standing regime of the Constitution, we are talking about the whole gambit of laws that would specify how this works. And in the area of the international treaties, it works in accordance with the Law of International Treaties. And as I have pointed out, the Russian Federation, in Article 23 of this law, went to a great pain to make the regime of the provisional application fit smoothly into the whole fabric of the Russian Constitution arrangement, including division of powers. I have pointed out Article 1 of the Russian Law on International Treaties includes this regime backwards, to all the treaties that were concluded in the time of the Soviet Union. (...) Q. (...) Okay, you agree that the Russian Constitution applies for the separation of powers, but at least in the treaty context you view that as nonetheless permitting the executive which signs treaties to provide provisional application of any treaty which therefore would be binding on the Russian state, whether or not the treaty is required to be ratified, or, if it is required to be ratified, ratified by the legislative branch; is that your view? A. No, sir, this is not my view at all. Let me explain it. First, my view is that Article 11, paragraph 3, is to be read in conjunction with Article 10, and it specifically refers to the fact that when you want to understand how the division of powers, separation of powers, works under the Russian legal system, the Constitution is not the end of the story. This is a very specific article, it is not always this way in the Constitution, but this article refers you to the laws. The separation of powers, which not surprisingly is not the -- the powers are not separated by a Berlin wall. They have to coordinate their work and to communicate with one another. And the precise way they do that is in a way that is prescribed by the federal law." (emphasis added)

⁵⁶⁹ In this context, see Professor Nussberger's Expert Opinion (**Exhibit RF-03.1.C-1.3.8**), pp. 15 et seq.

⁵⁷⁰ SoA, § 88.

393. As is evident from the above quote, Gladyshev was of the opinion at the time that Article 23 FLIT applied retroactively. Following Gladyshev, HVY relied on Article 23 FLIT more than once during the Arbitrations.⁵⁷¹ Only now, on appeal⁵⁷² – after the District Court has found HVY to be in the wrong – do HVY take an opposite position. They argue that Article 23 FLIT does not apply to the ECT:

“508. Article 23(2.2) FLIT did not apply to the ECT.

509. First, because the FLIT simply did not exist when the Russian Federation signed the ECT (...)

511. Second (...)”(emphasis added)⁵⁷³

394. The many pages dedicated to the “*dominant role of the President*”⁵⁷⁴ are implausible not only because they deviate from and are even contrary to positions taken earlier, but also because they are irrelevant. The long argument on the broad powers of the President ultimately leads to the conclusion that the Russian President, unlike for instance his French counterpart, is authorised to provisionally apply treaties without any limitation. Regardless of the merits of this conclusion, it is irrelevant in this case. Former President Yeltsin was not involved in the negotiations. Nor did he travel to Lisbon to sign the Treaty. President Yeltsin was not involved in the formation of the Treaty in any other way, either.⁵⁷⁵

395. Ultimately, Mr Davydov signed the ECT. A government decision dated 16 December 1994 shows that he was appointed by the government for that purpose.⁵⁷⁶ The key question, therefore, is whether the government was authorised to declare to unilaterally apply a Treaty deviating from federal legislation on dozens of points provisionally. Everything that was mentioned on the broad powers of President Yeltsin in this context is irrelevant. He was not involved in the signing of the Treaty. This Court of Appeal can dismiss the

⁵⁷¹ See for instance hearing transcript dated 28 November 2008, p. 121, which shows that HVY, following Gladyshev, also relied on Article 23 FLIT. The procedural documents also contain multiple references to Article 23 FLIT.

⁵⁷² It was not argued in the first instance either that Article 23(2) FLIT did not apply. See SoD, §§ II.215-225 and SoRej., §§ 100-104.

⁵⁷³ SoA, §§ 508-511.

⁵⁷⁴ See SoA, §§ 445 and 447.

⁵⁷⁵ Nor did HVY assert that President Yeltsin signed the Treaty, or authorised or ordered its signing.

⁵⁷⁶ Decision No. 1390 of the Government of the Russian Federation “*On the Signing of the Energy Charter Treaty and Related Documents*”, 16 December 1994, (C -1021). See Professor Avtonomov's Expert Opinion (**Exhibit RF-D4**), §§ 12-13 and 105.

concerned (and extensive) documents on this subject included in the Statement of Appeal, and all conclusions drawn therefrom, for that reason alone.⁵⁷⁷ To conceal this gaping hole in their reasoning, HVY added several occurrences of the words “*and the government*” to the Statement of Appeal. Naturally, this cannot detract from the fact that the key assertion, to wit that the Russian President has far-reaching powers, is irrelevant.⁵⁷⁸

396. The new assertions regarding the super powers of the Russian President are not only implausible and irrelevant. Moreover, as a primary rule, such assertions cannot be discussed in setting aside proceedings. Only a positive ruling on jurisdiction by a tribunal can be reviewed (see §§ 257-267 above). In addition – alternatively – it is contrary to due process of law, more specifically arbitration law, to adopt partly deviant positions on the 1993 Constitution in setting aside proceedings that should already have been discussed in the Arbitrations, subject to forfeiture of the right to take such positions (see §§ 268-277 above).

(g)(iii) *The 1993 Russian Constitution limits the government's and the President's power to apply treaties provisionally*

(g)(iii)(i) *HVY's discussion of the 1993 Constitution is one-sided, incorrect and misleading*

397. As has been explained above, the Constitution of the Soviet Union provided for the concentration of State Power (see § 155 above). The Supreme Soviet (Parliament) played an important role in that respect. The 1993 Constitution differs significantly from the constitution that preceded it. The new Constitution did in fact embrace the principle of the separation of powers. This Constitution therefore marked a break with the past. The Russian Constitution was strongly inspired by the French Constitution of 1958.⁵⁷⁹ That the new Constitution assigned broad powers to the Russian President – following the French President – does not change the fact that there is a system of “*checks and balances*”. Contrary to what HVY seem to argue, the Russian President is not all-powerful.

398. The 1993 Russian Constitution is shaped in such a way that it is impossible for the state authority to be concentrated. This was confirmed several times by the Russian

⁵⁷⁷ The entire fifth chapter of the SoA can be disregarded for this reason alone.

⁵⁷⁸ See also Professor Avtonomov's Expert Opinion (**Exhibit RF-D4**), §§ 12-13 and 101-110.

⁵⁷⁹ See Professor Avtonomov's Expert Opinion (**Exhibit RF-D4**), §§ 72-74, in which a comparison is drawn with the French legal system many times.

Constitutional Court.⁵⁸⁰ By way of example, reference can be made to a ruling dated 18 January 1996 explicitly rejecting the opinion formulated by HVY that there is a super-presidential concentration of power:

“The separation of the unified state power into legislative, executive and judicial implies the establishment of such a system of legal guarantees, checks and balances that excludes the possibility of concentration of power in one of them, ensures the independent functioning of all branches of government and simultaneously their interaction.”⁵⁸¹

399. In a similar vein, the Constitutional Court ruled on 29 May 1998 that the principle of the separation of powers does not allow one of the powers to subordinate the others:

“The principle of separation of powers implies not only the distribution of power between the organs of different branches of state power, but also the mutual balancing of the branches of power, the inability for one of them to subordinate others to themselves. In the form in which it is enshrined in the Constitution of the Russian Federation, this principle does not allow the concentration of functions of various branches of government in one body (...).”⁵⁸²

400. The Constitutional Court confirmed on 11 November 1999 that the separation of powers entails that no single branch of state power may exercise or demand powers not vested in it. This means that the President is not allowed to exercise the powers of Parliament, not even if the Duma has been dissolved:

“By virtue of Articles 10 and 11 of the Constitution of the Russian Federation and based on the system of checks and balances established by it, no state authorities may exercise, let alone usurp the constitutional powers that do not belong to them. In case of dissolution of the State Duma and appointment of the new elections, as provided by Articles 84(b), 109(1) and (2), 111(4) and 117(3) and (4) of the Constitution of the Russian Federation, the constitutional

⁵⁸⁰ See Professor Avtonomov's Expert Opinion, (**Exhibit RF-D4**), §§ 46-47.

⁵⁸¹ Constitutional Court Resolution No 2-P of 18 January 1996, English translation of the original Russian text: "*The separation of the unified state power into legislative, executive and judicial implies the establishment of such a system of legal guarantees, checks and balances that excludes the possibility of concentration of power in one of them, ensures the independent functioning of all branches of government and simultaneously their interaction.*"

⁵⁸² Constitutional Court Resolution No 16-P of Decree of 29 May 1998, English translation of the original Russian text: "*The principle of separation of powers implies not only the distribution of power between the organs of different branches of state power, but also the mutual balancing of the branches of power, the inability for one of them to subordinate others to themselves. In the form in which it is enshrined in the Constitution of the Russian Federation, this principle does not allow the concentration of functions of various branches of government in one body.*"

powers belonging to the State Duma, may not be exercised by the President of the Russian Federation. (...)”⁵⁸³

401. That the 1993 Constitution assigns broad powers to the Russian President therefore does not change the fact that these powers are limited. In any event, there is no such thing as a “*super-presidential democracy*” in which the President could completely brush aside the Parliament.
402. In the Russian Federation, the powers of the President are explicitly limited by law (see Article 15(2) of the Russian Constitution, see § 162 above). For example, the President is not allowed to issue orders or decrees that are inconsistent with federal legislation. This follows explicitly from Article 90(3) of the Russian Constitution:

“Article 90

1. The President of the Russian Federation shall issue decrees and orders.
2. The decrees and orders of the President of the Russian Federation shall be obligatory for fulfilment in the whole territory of the Russian Federation.
3. Decrees and orders of the President of the Russian Federation shall not run counter to the Constitution of the Russian Federation and federal laws.”⁵⁸⁴

403. The power of the President to issue decrees concerns no more than the power to remedy omissions if and for as long as certain matters are not provided for by federal law. In his expert opinion, Professor Avtonomov discusses that the President may issue a decree if no legislation is currently in place in a certain policy domain. Professor Avtonomov explains

⁵⁸³ Bulletin of the Constitutional Court of the Russian Federation. 1999. No. 6, as also quoted in Professor Avtonomov's Expert Opinion (**Exhibit RF-D4**), § 47 Shortened English version as cited by Professor Avtonomov: "By virtue of Articles 10 and 11 of the Constitution of the Russian Federation and based on the system of checks and balances established by it, no state authorities may exercise, let alone usurp the constitutional powers that do not belong to them....[T]he constitutional powers belonging to the State Duma, may not be exercised by the President of the Russian Federation, or by another house of the Federal Assembly - the Federation Council. ." Constitutional Court Resolution No. 15-P dated 11 November 1999 (ASA-043), English translation of the original Russian text: "In the Case on the Construction of Articles 84(b), 99 (1), (2) and (4), and 109(1) of the Constitution of the Russian Federation".

⁵⁸⁴ English translation of the original Russian text: "1. The President of the Russian Federation shall issue decrees and orders 2. The decrees and orders of the President of the Russian Federation shall be obligatory for fulfilment in the whole territory of the Russian Federation 3. Decrees and orders of the President of the Russian Federation shall not run counter to the Constitution of the Russian Federation and federal laws."

that, in the unforeseen event that there is any conflict between laws and decrees, the federal laws prevail over the decrees.⁵⁸⁵

404. The powers vested in the President on the conclusion of treaties is also limited by law or constitution. Russian legislation provides that treaties deviating from the law must be ratified by the Parliament (see inter alia §§ 166-176 above).

(g)(iii)(ii) *Constitutional practice makes it clear that the powers of the Russian President are limited*

405. In Professor Avtonomov's expert opinion, it is explained that President Yeltsin himself experienced the limitations to his powers under the new Constitution not even two months after the referendum on the Constitution. The new Parliament almost immediately enacted a new law granting amnesty to two imprisoned political adversaries of the President. These adversaries were the erstwhile Vice President of the Russian Federation, Aleksandr Roetskoj and the speaker of the Parliament, Ruslan Chasboelatov. President Yeltsin attempted to block this amnesty law, or at least to escape the effect thereof. He did not succeed. The Public Prosecution Service refused to follow his presidential instruction because these were unconstitutional. Roetskoj and Chasboelatov were therefore released shortly after the law was enacted.⁵⁸⁶
406. Another good example of President Yeltsin having to back down is when he attempted to reappoint Viktor Chernomyrdin as Prime Minister in 1998. President Yeltsin nominated Chernomyrdin as a candidate for this position on the basis of Article 111 of the Russian Constitution. The Duma rejected this suggestion on 31 August 1998. Immediately thereafter, President Yeltsin once again proposed appointing Chernomyrdin as Prime Minister. The proposal was rejected once more on 7 September 1998. President Yeltsin was then forced to nominate another candidate who could rely on the endorsement of the Duma (Yevgeny Primakov).⁵⁸⁷
407. The aforementioned examples are not isolated. President Yeltsin came into conflict with the Duma on many an occasion. In the 1995-1999 period, federal laws adopted by the Duma were vetoed by President Yeltsin no less than 260 times. In many cases, this ensured

⁵⁸⁵ Professor Avtonomov's Expert Opinion (**Exhibit RF-D4**), §§ 39, under C, 40, 44 and 107.

⁵⁸⁶ Expert opinion Professor Avtonomov (**Exhibit RF-D4**), § 109.

⁵⁸⁷ Expert opinion Professor Avtonomov (**Exhibit RF-D4**), § 109.

that the relevant legislative proposal would never enter into force. But such presidential vetoes are not absolute. If the legislative proposal is again submitted to the Duma and is approved by a qualified majority, the President is obliged to sign the legislative proposal.⁵⁸⁸ In the 1995-1999 period, a legislative proposal rejected by President Yeltsin was resubmitted to the Duma 58 times and subsequently approved by a qualified majority. In other words: President Yeltsin was compelled to cooperate with the formation of legislation he had previously vetoed 58 times.⁵⁸⁹

(g)(iii)(iii) *HVY wrongfully assert that the power to negotiate on a treaty also comprises the power to agree to the provisional application of a treaty without any limitations on behalf of a State*

408. HVY's central argument is that "government bodies that are authorised to negotiate on the contents of a treaty and to decide on the signing thereof (...) in the Russian Federation – like in most other legal systems – [are] also authorised to agree to provisional application in relation to that treaty".⁵⁹⁰ They argue that in the Russian Federation, like in many other countries, the power to negotiate on a treaty also comprises the power to apply a treaty provisionally.⁵⁹¹ According to HVY, all of this means that the government may agree on behalf of a State to agree to the provisional application of a treaty without involvement of the Parliament.⁵⁹²
409. For the record, the executive power in the Russian Federation is assigned to a large number of ministries, federal services and administrative bodies.⁵⁹³ The list of state authorities with the power to negotiate on treaties is long. In Professor Avtonomov's expert opinion, mention is made of over 70 executive authorities, such as the Ministry of Transport, the Federal Competition Authority, the Ministry of Sport, the Federal Agency for Youth Affairs and the Federal Agency for Ethnic Affairs.⁵⁹⁴ HVY's statements imply that each of these authorities has the power to provisionally apply treaties without any limitation. HVY

⁵⁸⁸ This ensues from Article 107 of the Russian Constitution.

⁵⁸⁹ Expert opinion Professor Avtonomov (Exhibit RF-D4), § 109.

⁵⁹⁰ SoA, § 425.

⁵⁹¹ SoA, § 432.

⁵⁹² SoA, § 446.

⁵⁹³ This follows from Articles 71 and 112 of the Russian Constitution and the legislation passed on the basis thereof.

⁵⁹⁴ Expert opinion Professor Avtonomov (Exhibit RF-D4), § 51.

claim that these are all authorised to set aside federal laws that were adopted with the assistance of the Parliament (and the President).

410. HVY's opinion is based on an incorrect interpretation of Article 23 FLIT.⁵⁹⁵ Article 23 FLIT provides that a state authority that takes the decision to sign an international treaty also takes the decision regarding the provisional application of such treaty. Article 23 FLIT therefore assumes that a “decision” (решение) is taken. This term "decision" is further defined in Article 6 FLIT. The said Article provides that state authorities may only take a “decision” (решение) regarding an international treaty in accordance with their *"competence established by the Constitution of the Russian Federation, the present Federal Law and any other legislative acts of the Russian Federation."*⁵⁹⁶ The above entails that the powers of state authorities to agree to provisional application on behalf of the Russian Federation are limited. Indeed, the Constitution provides that neither the government, nor any other state authority (such as the Federal Agency for Youth Affairs) is authorized to deviate from federal laws (see §§ 160 - 170 above). For a further explanation regarding the parliamentary history of Article 6 FLIT in which this is confirmed, see §§ 426-432 below. Since Article 45(1) of the ECT expressly limits the provisional application of the ECT to those provisions which are not inconsistent with the Russian Federation's Constitution and statutes, then the ability of the government to provisionally apply the ECT must also be limited in accordance with the government's Constitutional competence and any statutory restrictions imposed by the Federal Assembly.
411. HVY allege that the Russian government, like the Dutch government, plays an important role in determining and implementing foreign policy and is often actively involved in the formation of treaties.⁵⁹⁷ They argue that the Russian Federation, like the Netherlands, is a party to the Vienna Convention on the Law of Treaties and applies treaties provisionally with some regularity.⁵⁹⁸ They also make it clear that provisional application and the

⁵⁹⁵ The reliance on Article 23 (2) FLIT in SoA, § 435, is remarkable in view of HVY's argument that this provision allegedly does not apply. See §§ 390 et seq. above.

⁵⁹⁶ Expert opinion Professor Avtonomov (**Exhibit RF-D4**), § 85. Original English text: *"in accordance with [its] competence as established by the Constitution of the Russian Federation, this Federal Law and other legislative acts of the Russian Federation"*..

⁵⁹⁷ Compare HVY's statements in SoA, §§ 427 et seq.

⁵⁹⁸ Compare HVY's statements in SoA, §§ 434-438. It should be noted that the references to the FLIT, which entered into force at a later date, are irrelevant.

ratification of treaties are two different legal concepts.⁵⁹⁹ However, none of these arguments justifies the conclusion that the government is unilaterally and without any limitations authorised to provisionally apply treaties on behalf of the Russian Federation.⁶⁰⁰

412. HVY's assertion shows that HVY lack basic understanding of the doctrine of provisional application. That a government is authorised to negotiate on and in that context help to establish the text of a treaty (through signing it) in no way means that the government also has the power under national constitutional law to declare a treaty applicable unilaterally and without any limitations. For the sake of brevity, it suffices to make a reference here to expert opinions which show that, although the government may negotiate on a treaty in France, Germany, Austria, Finland and the Netherlands, the government's power to agree to the provisional application of treaties on behalf of the State is nevertheless limited.⁶⁰¹ For example, the Dutch government can negotiate on a treaty that deviates from formal laws, but it is not unilaterally authorised to proceed to apply such treaties provisionally on behalf of the State of the Netherlands.⁶⁰²
413. In the Russian Federation, as is the case in the Netherlands, the government is not independently authorised to enter into treaty obligations – for a period of 20 years! – that deviate from existing laws on behalf of the Russian Federation. As explained above with reference to a large number of sources, this means that the powers of the Russian government to proceed to provisionally apply treaties on behalf of the State are also limited (see §§ 162, 164 above and §§ 426-432 below). The Russian government could only sign the ECT because Article 45(1) ECT explicitly limits the scope of the provisional application.

⁵⁹⁹ Compare HVY's statements in SoA, §§ 450-454.

⁶⁰⁰ It is for example striking how often HVY refer to Article 23(1) FLIT, even though the parties agree that the FLIT does not apply. Pursuant to a presidential scheme, only Article 23(2) FLIT is relevant. The fact that HVY indeed fails to mention this particular provision – from which it clearly follows that the powers of the government are limited – is telling.

⁶⁰¹ See, *inter alia*, Koskenniemi's Expert Opinion (**Exhibit RF-03.1.C-1.3.4**), § 23, Professor Talus's Expert Opinion, §§ 26-30 (**Exhibit RF-D11**), Professor Nolte's 2006 Expert Opinion (**Exhibit RF-03.1.C-1.3.7**), § 38, Professor Nolte's 2016 Expert Opinion (**Exhibit RF-13**), §§ 20-31, 51, Hafner's Expert Opinion (**Exhibit RF-03.1.C-1.3.11**), §§ 22-26, Professor Pellet's 2006 Expert Opinion (**Exhibit RF-03.1.C-1.3.9**) §§ 34-35, Professor Nouvel's Expert Opinion (**Exhibit RF-D10**), §§ 39-69 and Professor Heringa's Expert Opinion, (**Exhibit RF-D1**), §§ 9-12.

⁶⁰² See Professor Heringa's Expert Opinion, (**Exhibit RF-D1**), §§ 9-12.

(g)(iii)(iv) *HVY wrongfully assert that the absence of a specific prohibitory provision means that the Russian government may provisionally apply treaties that deviate from the law.*

414. In 1994, there was no elaborate statutory provision on the provisional application of treaties in the Russian Federation.⁶⁰³ On this basis, HVY arrive at the far-reaching conclusion that the President – or at least the government – was “therefore” authorised, without any limitations, to declare to apply treaties: *“For that reason, the power of the President and the government to agree to the provisional application of treaties under Russian law also comprises the power to agree to the provisional application of treaties that must be ratified before they can definitively enter into force, for example because they are a supplement to or differ from existing Russian laws.”*⁶⁰⁴
415. That the Russian Federation did not have any specific detailed statutory provision on provisional application, however, in no way means that the Russian President was all-powerful in this respect. Indeed, the powers of the Russian President and the Russian government were, and still are, limited by the general principles and basic assumptions laid down in the Russian Constitution and in federal laws.⁶⁰⁵ In this context, Articles 15(2) and 115(1) of the Russian Constitution are also relevant (see §§ 162 et seq. above). Article 115 provides that the government only has the power to act if this is evident from the Constitution, federal laws or presidential decrees.⁶⁰⁶ Accordingly, non-ratified treaties can be implemented only to the extent that they are compatible with federal laws.⁶⁰⁷ Russian courts may and must review laws and treaties against the Russian Constitution.⁶⁰⁸ Kartsov's

⁶⁰³ See SoA, § 488. Naturally, one could revert to the general provisions of the Russian Constitution.

⁶⁰⁴ See SoA, §§ 455-459 and 488-490.

⁶⁰⁵ See *inter alia* §§ 160-164 and 410 above.

⁶⁰⁶ Constitution of the Russian Federation, Article 115(1) (R-163), English translation of the original Russian text: *“1. On the basis and for the sake of implementation of the Constitution of the Russian Federation, the federal laws, normative decrees of the President of the Russian Federation, the Government of the Russian Federation shall issue decisions and orders and ensure their implementation.”* English translation of the original Russian text: *“On the basis and for the sake of implementation of the Constitution of the Russian Federation, federal laws, normative decrees of the President of the Russian Federation the Government of the Russian Federation shall issue decisions and orders and ensure their implementation.”*

⁶⁰⁷ Cassation Ruling No. 59-O09-35 of the Supreme Court of the Russian Federation (29 December 2009), Section 4 (**Exhibit RF-125**).

⁶⁰⁸ See § 425 for an example. The Russian Federation does not know any provision that corresponds with Article 120 of the Dutch Constitution.

publication, cited by HVY, rightfully makes it clear that the Constitutional Court must safeguard the “*constitutionality of the procedures regarding provisional application*”.⁶⁰⁹

416. For decades, the Dutch legal system did not have any statutory provision regarding the provisional application of treaties either. Naturally, that did not mean that the Dutch government was “therefore” authorised to decide to provisionally apply treaties without any limitation. At the time, based on general principles under constitutional law, the government in the Netherlands could only agree to the provisional application of a treaty on behalf of the Netherlands if the provisional application was limited to what the government could implement without requiring the Parliament's further cooperation.⁶¹⁰ This rule has meanwhile been codified and reference can be made to a specific statutory provision. Article 15(2) of the Dutch Treaties (Approval and Publication) Kingdom Act provides that a treaty may not be applied provisionally if the treaty deviates from the law or requires such deviation from the law.⁶¹¹
417. Many States still do not have specific statutory provisions on the scope of the government's powers to proceed with the provisional application of a treaty on behalf of the State. The Russian Constitution is strongly influenced by the French law.⁶¹² In France, too, there is no particular provision in the Constitution that limits the power of the President to declare to apply a legislative treaty provisionally. Nevertheless, it is assumed in France that such a limitation follows from the general constitutional rule that treaties that deviate from the law must be approved by the French Parliament.⁶¹³

⁶⁰⁹ In SoA § 456, HVY selectively quote from Kartsov’s publication, which has been submitted to the Court as Exhibit M-73 to Mishina’s opinion (Exhibit HVY-D4). As a result, HVY draw incorrect conclusions from this publication. The quote reads as follows in the English translation: “*constitutionality of the procedures for provisional application*”.

⁶¹⁰ In this context, see Professor Heringa's Expert Opinion (**Exhibit RF-D1**) (in particular §§ 4-5) and 53 above.

⁶¹¹ Dutch law differs from that of other states precisely because it contains such an explicit statutory provision. This is exactly Kartsov’s point in the quote made by HVY in SoA, § 456. For a discussion of the Dutch rule, see Professor Heringa’s expert opinion (**Exhibit RF-D1**), §§ 9-12.

⁶¹² See Professor Avtonomov’s Expert Opinion (**Exhibit RF-D4**), §§ 72-74, in which a comparison is drawn with the French legal system many times.

⁶¹³ In this context, see Professor Pellet's previously cited 2006 Expert Opinion (**Exhibit RF-03.1.C-1.3.9**), §§ 5-37, and Professor Nouvel's Expert Opinion (**Exhibit RF-D10**), §§ 16-69, with reference to Articles 52-55 of the French Constitution.

418. HVY's statement, to wit that the absence of a provision like Article 15(2) of the Dutch Kingdom Act means that the government is "therefore" all-powerful, does not make sense. This would mean that the government could unilaterally brush aside federal laws and could deviate from the division of powers provided for in the Russian Constitution.

(g)(iv) *The District Court correctly held that only ratified treaties prevail over federal laws, and HVY's reliance on Article 15(4) of the Russian Constitution fails (grounds 5.87-5.93)*

(g)(iv)(i) *The conflict rule of Article 15(4) of the Russian Constitution*

419. Article 15(4) of the Russian Constitution provides that international treaties of the Russian Federation form part of the legal system of the Russian Federation. In the hierarchy of legal standards, international treaties of the Russian Federation rank higher than federal laws. Article 15(4) of the Russian Constitution reads as follows:

"The universally-recognised standards and provisions of international law and international treaties and agreements of the Russian Federation shall be a component part of its legal system. If an international treaty or agreement of the Russian Federation establishes other rules than those envisaged by law, the rules of the international agreement shall be applied."⁶¹⁴

420. The Russian Federation notes that Article 15(4) of the Constitution is not relevant in this case. This constitutional provision prescribes that obligations arising from international treaties⁶¹⁵ prevail over conflicting federal laws. Article 15(4) of the Constitution is a rule on conflict of laws. As explained in detail above, Article 45 ECT safeguards that no treaty obligations will arise on the part of the Russian Federation that are incompatible with Russian law. Indeed, Article 45 ECT prescribes that even very low-ranked provisions (such as municipal by-laws) could have the effect that international law does not require a state to provisionally apply a specific provision of the Treaty. Therefore, there can never be any conflict that should be solved by rules on conflict of laws contained in Article 15 of the

⁶¹⁴ Constitution of the Russian Federation, Article 15(4) (R-163). English translation of the original Russian text: "*The universally-recognised norms of international law and international treaties and agreements of the Russian Federation shall be a component part of its legal system. If an international treaty or agreement of the Russian Federation establishes other rules than those envisaged by law, the rules of the international agreement shall be applied.*"

⁶¹⁵ This pertains to ratified treaties, as is explained below.

Russian Constitution.⁶¹⁶ That is why HVY have no interest in the grounds of appeal that pertain to Article 15 of the Constitution.⁶¹⁷

(g)(iv)(ii) *The District Court rightly held that only treaties ratified by the Parliament prevail over federal laws (ground 5.91)*

421. Article 15 of the Russian Constitution gives priority to “*international treaties and agreements of the Russian Federation*”. HVY argue, as in the Arbitrations, that a treaty that has not been approved but is only applied provisionally supposedly qualifies as an “*international treaty of the Russian Federation*”. They hold the view that a treaty such as the ECT therefore prevails over federal laws.⁶¹⁸
422. The District Court rejected this position of HVY. The Russian Federation did not ratify the ECT. It did not give its consent to be bound by this Treaty. Consequently, the ECT does not qualify as an “*international treaty of the Russian Federation*” as referred to in Article 15 of the Constitution. The District Court correctly held that only treaties that have been ratified and have entered into force prevail over federal laws.⁶¹⁹

“5.91. The court shares the interpretation of Article 15 paragraph 4 of the Constitution as can be read in the opinions of the experts on which the Russian Federation relies. This interpretation is also supported in the resolutions mentioned by the Russian Federation in section 135 of the statement of reply of 31 October 1995 and of 10 October 2003 of the Russian Supreme Court and of 6 November 2014 of the Constitutional Court (see: statement of reply, 135). A different interpretation of Article 15 paragraph 4 of the Constitution would allow treaties not approved by the legislature to form part of Russian law and also supersede legislation not compatible with such treaties. Such an interpretation cannot be reconciled with the principle of separation of powers.”

⁶¹⁶ This District Court ruling is in accordance with the Russian Federation’s position. See, for example, SoR §§ 130 and 132.

⁶¹⁷ See SoD § II.193 and SoA §§ 463-466.

⁶¹⁸ See SoD § II.193 and SoA §§ 463-466. In the Arbitrations, HVY submitted an opinion drawn up by Gladyshev. Gladyshev was for some time affiliated with the Amsterdam & Peroff firm, which firm at the time acted on behalf of Khodorkovsky. Gladyshev argued that all treaties, regardless whether these have been approved, prevail over Russian federal laws. Gladyshev Opinion, nos. 19, 55, 56. In response to this, see Professor Nussberger's Expert Opinion, already submitted in the Arbitrations (**Exhibit RF-03.1.C-1.3.8**), thesis 3 (pp. 26 et seq.).

⁶¹⁹ See SoR, §§ 135-136.

423. Below, it will be explained that the District Court's judgment is in line with established case law (subsection (g)(iv)(iii)), the legislative history (subsection (g)(iv)(iv)) and the legal literature (subsection (g)(iv)(v)).

(g)(iv)(iii) *The District Court correctly held that established case law demonstrates that only ratified treaties prevail over federal laws*

424. The District Court's judgment is completely in line with the established case law of the highest Russian Courts. After all, it follows from the said case law that only international treaties of the Russian Federation that have entered into force, and for which consent to be bound thereto has been given in the form of a federal law, prevail over federal laws. Examples of (standard) decisions include:

(a) Resolution No. 8 of the Plenum of the Russian Supreme Court "On Certain Issues of Application by Courts of the Constitution of the Russian Federation in Administering Justice" of 31 October 1995:

"The same constitutional provision [Article 15(4)] stipulates that if an international treaty of the Russian Federation establishes rules different from those provided for by law, the rules of the international treaty shall be applied. In light of the above, when considering a case, the court may not apply the rules of any law governing legal relations if an international treaty, that has entered into force for the Russian Federation and the decision of the Russian Federation to be bound by which was taken in the form of a federal law, establishes rules different from those provided for by such law. In these situations the rules of the international treaty of the Russian Federation shall be applied."⁶²⁰ (emphasis added)

(a) Resolution No. 5 of the Plenum of the Russian Supreme Court of 10 October 2003:

"The rules of an international treaty of the Russian Federation that has entered into force and consent to be bound by which was given

⁶²⁰ Resolution No. 8 of the Russian Supreme Court "On Certain Issues of Application by Courts of the Constitution of the Russian Federation in Administering Justice" (31 October 1995), Section 5 (**Exhibit RF-122**): English translation of the original Russian text: "*The same constitutional provision [Article 15(4)] stipulates that if an international treaty of the Russian Federation establishes rules different from those provided for by law, the rules of the international treaty shall be applied. In light of the above, when considering a case, the court may not apply the rules of any law governing legal relations if an international treaty, that has entered into force for the Russian Federation and the decision of the Russian Federation to be bound by which was taken in the form of a federal law, establishes rules different from those provided for by such law. In these situations the rules of the international treaty of the Russian Federation shall be applied.*" (emphasis added).

in the form of a federal law shall be applied with priority over the laws of the Russian Federation. The rules of an international treaty of the Russian Federation that has entered into force and consent to be bound by which was given other than in the form of a federal law shall be applied with priority over legislative legal acts issued by a State authority or an authorized agency that has entered into that particular treaty (Article 15(4), Article 90, 113 of the Constitution of the Russian Federation)” (emphasis added)⁶²¹

- (b) Judgment No. 2531-O of the Plenum of the Russian Constitutional Court of 6 November 2014:

“The Plenum of the Supreme Court of the Russian Federation has repeatedly noted the priority of an international treaty of the Russian Federation that has entered into force and consent to be bound by which was given in the form of a federal law over laws of the Russian Federation (...)”(emphasis added)⁶²²

- (c) Resolution No. 5-APU15-68 of the Plenum of the Russian Supreme Court of 8 September 2015:

"until ratification and official publication, the Fourth Additional Protocol to the European Convention on Extradition may not be applied and does not have the priority over the provisions of laws of the Russian Federation, including the Code of Criminal Procedure of the Russian Federation, in particular Paragraph 4 Part 1, Art.464 of the CCP of the Russian Federation."⁶²³

⁶²¹ Resolution No. 5 of the Plenum of the Supreme Court of the Russian Federation "On Application by Courts of General Jurisdiction of Generally Recognized Principles and Rules of International Law and International Treaties of the Russian Federation" (Oct. 10, 2003), Section 8 (**Exhibit RF-123**) (English translation of the original Russian text): "*The rules of an international treaty of the Russian Federation that has entered into force and consent to be bound by which was given in the form of a federal law shall be applied with priority over the laws of the Russian Federation. The rules of an international treaty of the Russian Federation that has entered into force and consent to be bound by which was given other than in the form of a federal law shall be applied with priority over sub-legislative legal acts issued by a State authority or an authorized agency that has entered into that particular treaty (Article 15(4), Article 90, 113 of the Constitution of the Russian Federation).*" (emphasis added). The Russian Federation never consented to be bound by the Treaty. This means that the Treaty cannot have priority over federal laws.

⁶²² Ruling No. 2531-O of the Constitutional Court of the Russian Federation (Nov. 6, 2014), Section 3 (**Exhibit RF-124**): It becomes clear from this ruling that the Constitutional Court agrees with the aforementioned resolutions of the Supreme Court; "*The Plenum of the Supreme Court of the Russian Federation has repeatedly noted the priority of an international treaty of the Russian Federation that has entered into force and consent to be bound by which was given in the form of a federal law over laws of the Russian Federation.*(...)" (emphasis added)

⁶²³ Appellate Ruling of the Russian Federation Supreme Court dated 08/09/2015 in case No.5-APU15-68 (**Exhibit RF-293**). English translation of the original Russian text: "*until ratification and official publication, the Fourth Additional Protocol to the European Convention on Extradition may not be applied and does not have the priority over the provisions of laws of the Russian Federation, including*

425. These (and other) judgments confirm the manner in which the separation of powers is designed in the Russian constitutional system (see § 155 et seq. above). Treaties approved by the Parliament prevail over federal laws. Non-ratified treaties, however, are subordinate to federal laws under the Russian constitutional law.⁶²⁴ The latter can be exemplified on the basis of a Supreme Court ruling dated 29 December 2009. This ruling pertains to a treaty between the Russian Federation and China, which contained provisions that differed from federal criminal law. The treaty was not ratified by the Russian Parliament. The Supreme Court makes clear that, pursuant to Article 115 of the Russian Constitution, the government is not authorised to issue rules that are inconsistent with federal laws. This means that the government is also not authorised to enter into treaty obligations that differ from federal laws on behalf of the Russian Federation. The Supreme Court confirms that the non-ratified treaty cannot be applied to the extent that it is inconsistent with federal laws:

“The Treaty on the Russian-Chinese Border Regime was entered into on behalf of the Government of the Russian Federation and the Government of the Chinese People’s Republic. Consequently, this treaty falls within the category of intergovernmental treaties, the status of which within the Russian legal system depends on the powers of the supreme executive body.

As follows from Article 115 of the Constitution of the Russian Federation, resolutions and orders of the Government of the Russian Federation shall be consistent with the Constitution of the Russian Federation, federal laws, as well as decrees of the President of the Russian Federation.

Thus, the terms of a non-ratified intergovernmental treaty shall not contradict the Constitution of the Russian Federation, federal laws or decrees of the President of the Russian Federation.

International treaties of the Russian Federation, whereby the consent to be bound by these was given by the government of the Russian Federation, have priority over decisions and regulations⁶²⁵ of the Government and decisions and regulations of federal executive bodies.

By virtue of the hierarchy of legal acts, priority over the laws of the Russian Federation is accorded to international treaties of the Russian Federation

the Code of Criminal Procedure of the Russian Federation, in particular Paragraph 4 Part 1, Art.464 of the CCP of the Russian Federation."

⁶²⁴ In this context, see for example a judgment of the Federal Arbitrazh Court of the Central District, 15 January 2003, case No. A14-6964/02/203/27.

⁶²⁵ Note with regard to the translation. The Russian source text uses the term "акты", which here has been translated as "*besluiten en voorschriften*" [decisions and regulations]. The Russian term has been defined in Article 23 of the Federal Constitutional Law No. 2-FKZ of 17 December 1997 "On the Government of the Russian Federation" (R-427).

concluded on behalf of the Russian Federation (interstate treaties), consent to be bound by which was given in the form of a federal law.

The Treaty between the Government of the Russian Federation and the Government of the Chinese People's Republic on the Russian-Chinese Border Regime dated November 9, 2006 does not come within this category of treaties.

(...) Since the Government of the Russian Federation is not entitled to adopt, amend or abrogate the provisions of criminal laws or laws on criminal procedure, the provisions of the non-ratified Treaty between the Government of the Russian Federation and the Government of the Chinese People's Republic on the Russian-Chinese Border Regime dated November 9, 2006, to the extent it provides for rules different from those provided for by the Russian Criminal Code and the Russian Criminal Procedure Code, shall not apply in the Russian Federation." (emphasis added)⁶²⁶

(g)(iv)(iv) *The District Court's judgment corresponds to the legislative history*

426. The formation of Article 15(4) of the 1993 Constitution confirms that a treaty deviating from federal legislation only rank higher if the treaty has been approved by the Parliament.⁶²⁷ Accordingly, Oleg Rummyantsev, Secretary of the Constitutional Commission, explained at the oral hearing that only ratified treaties are given priority. If

⁶²⁶ Cassation Ruling No. 59-009-35 of the Supreme Court of the Russian Federation (29 December 2009), Section 4 (**Exhibit RF-125**). English translation of the original Russian text: "*The Treaty on the Russian-Chinese Border Regime was entered into on behalf of the Government of the Russian Federation and the Government of the Chinese People's Republic. Consequently, this treaty falls within the category of intergovernmental treaties, the status of which within the Russian legal system is dependent on the powers of the supreme executive body. As follows from Article 115 of the Constitution of the Russian Federation, resolutions and orders of the Government of the Russian Federation shall be consistent with the Constitution of the Russian Federation, federal laws, as well as decrees of the President of the Russian Federation. Thus, the terms of a non-ratified intergovernmental treaty shall not contradict the Constitution of the Russian Federation, federal laws or decrees of the President of the Russian Federation. International treaties of the Russian Federation, consent to be bound by which was given by the Government of the Russian Federation, have priority over legal acts of the Government and of federal executive bodies. By virtue of the hierarchy of legal acts, priority over the laws of the Russian Federation is accorded to international treaties of the Russian Federation concluded on behalf of the Russian Federation (interstate treaties), consent to be bound by which was given in the form of a federal law. The Treaty between the Government of the Russian Federation and the Government of the Chinese People's Republic on the Russian-Chinese Border Regime dated November 9, 2006 does not come within this category of treaties. (...) Since the Government of the Russian Federation is not entitled to adopt, amend or abrogate the provisions of criminal laws or laws on criminal procedure, the provisions of the non-ratified Treaty between the Government of the Russian Federation and the Government of the Chinese People's Republic on the Russian-Chinese Border Regime dated November 9, 2006, to the extent it provides for rules different from those provided for by the Russian Criminal Code and the Russian Criminal Procedure Code, shall not apply in the Russian Federation." (emphasis added)*

⁶²⁷ See Professor Avtonomov's Expert Opinion (**Exhibit RF-D4**), §§ 59 et seq. In this context, see also Nussberger's Expert Opinion (**Exhibit RF-03.1.C-1.3.8**), p. 29.

the government on behalf of the Russian Federation agrees to be bound by a treaty⁶²⁸, the provisions of such treaty will not have priority over federal laws:

“[L]egally concluded intergovernmental agreements that are not subject to ratification become part of the law. Their supremacy is only if they are ratified (...) Part of the domestic law is ratified international treaties and non-ratified simple intergovernmental agreements, if they do not conflict with the law. If the international treaty is ratified, then its norms are in effect, it is as if higher.”⁶²⁹

427. Previous draft versions of Article 15(4) of the Constitution explicitly included the addition that only ratified treaties prevail over laws. The word “*ratified*” has not been included in the final wording of the Article. The reason for this was – as Professor Avtonomov outlined in his expert opinion – that ratification is not always sufficient.⁶³⁰ Mr Kolbasov – who was a Deputy Minister at the time – pointed out that a treaty may well have been ratified, but that this does not imply that it entered into force.⁶³¹ Many treaties enter into force only after a specific number of States has ratified the treaty, a certain period of time has passed, or other filing requirements or publication requirements have been met. This entails that it can well be conceived that a treaty can not be applied with priority in spite of the parliamentary approval.⁶³²

⁶²⁸ Under Russian law – just like Dutch law – it is conceivable that a treaty only covers insignificant subjects on which the government can decide independently. In other words: this concerns treaties that do not deviate from the law or that necessitate such deviations. See Professor Avtonomov’s Expert Opinion, (**Exhibit RF-D4**), §§ 50 - 51. Naturally, the ECT cannot be considered such a treaty.

⁶²⁹ Expert opinion Professor Avtonomov, (Exhibit RF-D4), § 59. Original English text: “*[L]egally concluded intergovernmental agreements that are not subject to ratification become part of the law. Their supremacy is only if they are ratified. . . . Part of the domestic law is ratified international treaties and non-ratified simple intergovernmental agreements, if they do not conflict with the law. If the international treaty is ratified, then its norms are in effect, it is as if higher.*”

⁶³⁰ That the word “ratified” was ultimately deleted from the legislative text does not in any way mean that ratification is never required to apply a treaty with priority, as HVY assert in SoA, § 464, with reference to Dr Mishina’s opinion, §§ 188-190. See in detail: Expert Opinion Professor Avtonomov (**Exhibit RF-D4**), §§ 127-133.

⁶³¹ Expert opinion Professor Avtonomov, (**Exhibit RF-D4**), § 132.

⁶³² In exceptional cases, it is also conceivable that approval is not a hard requirement, for example, if the treaty merely pertains to relatively insignificant matters that the government itself can decide on pursuant to a statutory (delegation) provision (see §§ 167 et seq. above). See Nussberger’s expert opinion (**Exhibit RF-03.1.C-1.3.8**), p. 29. See for example also S. Pritzkow, *Das völkerrechtliche Verhältnis zwischen der EU und Russland im Energiesektor*, Springer, 2011, pp. 92-93 (**Exhibit RF-230**).

UNOFFICIAL TRANSLATION

This text is an unofficial translation of the Dutch original. In case of any discrepancies, the Dutch original shall prevail.

428. Eventually, a choice was made to keep the constitutional arrangements regarding the conclusion of treaties very concise. It was considered desirable to implement a more detailed set of rules in a federal law: the Federal Law on International Treaties ("FLIT").
429. Much of the preparatory work to draft the FLIT was done by a committee that included experts in the field of international law. This committee discussed the constitutional framework in great detail as well as Article 15(4) of the Russian Constitution. From the committee's hearings it follows that only treaties that have been ratified by Parliament have priority over federal laws. Neither the government nor the President is competent to unilaterally modify federal legislation, or to set such legislation aside in any other way:

"A.G. KHODAKOV

(...) But as far as treaties that amend federal law are concerned, then it is written in this draft that they are subject to ratification. That means that federal law can only be amended by a ratified treaty.

As regards those treaties that are not ratified, they cannot by definition amend the law, and thus even being a part of our legal system, in accordance with what is written here and in the Constitution, they will not have force that prevails over the force of the law. (...)

V.N. TROFIMOV

(...) Another question. (...) You, as it were, touched on paragraph 4 of Article 15 of the Constitution (...) Do you still believe that it somehow follows from this wording that if a treaty has not been ratified, then it does not take precedence?

B.I. OSMININ

There is a paragraph 2 in Article 6. Please read it, so that everyone understands.

V.N. TROFIMOV

Are you referring to the draft? A decision on consent for the Russian Federation to be bound by international treaties is adopted by the state authorities of the Russian Federation in accordance with the competence established by the Constitution of the Russian Federation (...)

A.G. KHODAKOV

This means what I was talking about. Sorry, Boris Ivanovich. This means that you cannot take one article from the Constitution and interpret it in isolation from the context of the entire Constitution and the legislative acts that elaborate on the Constitution. *It is this statute that renders impossible the*

situation that you are talking about, Vladimir Nikolayevich. Because here, in this statute, in the draft that we are discussing, it is written in black and white that a treaty that makes provision for amendments as compared with the existing rules of the statute is subject to ratification. That says it all. And in the context of this article of the draft Law and the Constitution, this issue does not arise. An international treaty that has not been ratified cannot change the statute.

B.I. OSMININ

It is said here that consent, whether by Parliament, or by the President, or by the Government, or by a department, to Russia being bound by an international treaty is granted only in accordance with their competence. And no more than that. A departmental treaty does not have the right to change the law. Neither does the Government, if the Government takes a decision, nor the President. Only, if it is approved in the form of ratification, signed by the President, only then can this treaty be above the law. Only in this particular case." (emphasis added)⁶³³

⁶³³ See Professor Avtonomov's Expert Opinion (**Exhibit RF-D4**), §§ 115-118, with reference to the relevant committee's hearings, pp. 54, 58, 59 and 60. English translation of the original Russian text: "A.G. KHODAKOV

(...) But as far as treaties that amend federal law are concerned, then it is written in this draft that they are subject to ratification. That means that federal law can only be amended by a ratified treaty. As regards those treaties that are not ratified, they cannot by definition amend the law, and thus even being a part of our legal system, in accordance with what is written here and in the Constitution, they will not have force that prevails over the force of the law. (...)

V.N. TROFIMOV

(...) Another question. (...) You, as it were, touched on paragraph 4 of Article 15 of the Constitution (...) Do you still believe that it somehow follows from this wording that if a treaty has not been ratified, then it does not take precedence?

B.I. OSMININ

There is a paragraph 2 in Article 6. Please read it, so that everyone understands.

V.N. TROFIMOV

Are you referring to the draft? A decision on consent for the Russian Federation to be bound by international treaties is adopted by the state authorities of the Russian Federation in accordance with the competence established by the Constitution of the Russian Federation (...)

A.G. KHODAKOV

This means what I was talking about. Sorry, Boris Ivanovich. This means that you cannot take one article from the Constitution and interpret it in isolation from the context of the entire Constitution and the legislative acts that elaborate on the Constitution. It is this statute that renders impossible the situation that you are talking about, Vladimir Nikolayevich. Because here, in this statute, in the draft that we are discussing, it is written in black and white that a treaty that makes provision for amendments as compared with the existing rules of the statute is subject to ratification. That says it all. And in the context of this article of the draft Law and the Constitution, this issue does not arise. An international treaty that has not been ratified cannot change the statute.

B.I. OSMININ

It is said here that consent, whether by Parliament, or by the President, or by the Government, or by a department, to Russia being bound by an international treaty is granted only in accordance with their

430. The Deputy Minister of Foreign Affairs – Mr Krylov – presented the legislative proposal of the Federal Law on International Treaties to the State Duma. Mr Krylov orally presented the proposal. On that occasion, he stressed that it follows from Article 15(4) of the Constitution that only treaties that have been ratified have priority over federal laws.

"The most important issue of constitutional significance is the question of which international treaties are subject to ratification. Their list is contained in Article 15 of the bill, the text of which has been distributed to you, and it is much broader than what was in the previous law.

I would like to draw your attention to the fact that only those treaties that are ratified in Parliament and therefore are approved in the form of a law will have priority in legislation in the event of a conflict of laws. Unlike the law of 1978, the new document introduced to you has introduced new rules – on provisional application of a treaty before its entry into force. This is standard international practice, provided for by the Vienna Convention, however, our draft law establishes firmly that the State Duma will monitor such application especially strictly (...)." (emphasis added)⁶³⁴

431. During the parliamentary hearings on the FLIT, Professor Osminin confirmed that only ratified treaties have priority over federal laws. Professor Osminin put it as follows:

"(...) Article 15, Part 4 of the Constitution determines that the generally accepted principles of international law and international treaties are a component element of the legal system of the Russian Federation. (...)

Furthermore, international treaties that have been ratified by Parliament, in accordance with the Constitution, take precedence over our law, insofar as if an international treaty provides for rules different to those provided for by our law, the rules of the international treaty apply."⁶³⁵ (emphasis added)

competence. And no more than that. A departmental treaty does not have the right to change the law. Neither does the Government, if the Government takes a decision, nor the President. Only, if it is approved in the form of ratification, signed by the President, only then can this treaty be above the law. Only in one instance."

⁶³⁴ Expert opinion Professor Avtonomov, (Exhibit RF-D4), § 62. Original English text: "*The most important issue of constitutional significance is the question of which international treaties are subject to ratification. Their list is contained in Article 15 of the bill, the text of which has been distributed to you, and it is much broader than what was in the previous law.*

I would like to draw your attention to the fact that only those treaties that are ratified in Parliament and therefore are approved in the form of a law will have priority in legislation in the event of a conflict of laws. Unlike the 1978 law, the document presented to you contains new rules—on the provisional application of a treaty prior to its entry into force. This is standard international practice, provided for by the Vienna Convention, however, our draft law establishes firmly that the State Duma will monitor such application especially strictly (...)."

⁶³⁵ See Professor Avtonomov's Expert Opinion (**Exhibit RF-D4**), § 119, annex ASA-024. Original English text: "*(...) Article 15, Part 4 of the Constitution determines that the generally accepted principles of international law and international treaties are a component element of the legal system of the Russian*

432. It follows that the decision of the District Court is in full conformity with the legislative history. HVY's assertions to the contrary – based on an own, unsubstantiated view on the formation of Article 15 of the Constitution and Professor Osminin's arguments – fail.⁶³⁶

(g)(iv)(v) *The District Court's judgment is accepted in the legal literature*

433. As early as 1994, Professor A.N. Talalayev pointed out that the constitutional requirement that treaties are subject to ratification is of great significance. According to Professor Talalayev, a treaty can as a result thereof only prevail over federal laws after ratification:

"(...) It would be a violation of the hierarchy of state authorities established in our legal system, to allow, for instance, the authorities executing interagency or even intergovernmental treaties to use them to appropriate the exclusive competence of the supreme legislative body, for such treaties to be made in violation of the statutes, let alone the Constitution of the Russian Federation. Where a treaty contains rules that require amending a Russian law or annulling it, such a treaty must be submitted for ratification to the State Duma, irrespective of whether the treaty itself provides for its ratification. By being ratified in the form of a law, such a treaty (even an interagency one) will prevail over the law."⁶³⁷

434. The view that only ratified treaties prevail over conflicting federal laws is accepted by most – if not all – authoritative legal experts. In this respect, reference could be made to the works of Professors Marchenko, Shlyantsev, Tuzmukhamedov, Ivanenko, Zimnenko, Marochkin and Ignatenko, among others.⁶³⁸ This generally accepted view makes sense.

Federation. (...) Furthermore, international treaties that have been ratified by Parliament, in accordance with the Constitution, take precedence over our law, insofar as if an international treaty provides for rules different to those provided for by our law, the rules of the international treaty apply." (emphasis added)

⁶³⁶ HVY's assertions to the contrary in SoA § 464, with reference to Dr Mishina's opinion (§§ 188-190), are incorrect. It also follows that HVY incorrectly presented Professor Osminin's position (SoA, §§ 451 and 455, with reference to the expert opinions by Professor Stephan and Dr Mishina). See also Professor Avtonomov's Expert Opinion, (**Exhibit RF-D4**), §§ 111-126.

⁶³⁷ Professor Avtonomov's Expert Opinion (**Exhibit RF-D4**), § 64, with reference to Talalayev A.N. Correlation of International and National Law and the Constitution of the Russian Federation. Moscow Journal of International Law. 1994. No. 4. p. 13. Original English text: "... *It would be a violation of the hierarchy of state authorities established in our legal system, to allow, for instance, the authorities executing interagency or even intergovernmental treaties to use them to appropriate the exclusive competence of the supreme legislative body, for such treaties to be made in violation of the statutes, let alone the Constitution of the Russian Federation. Where a treaty contains rules that require amending a Russian law or annulling it, such a treaty must be submitted for ratification to the State Duma, irrespective of whether the treaty itself provides for its ratification. By being ratified in the form of a statute, such a treaty (even an interagency one) will prevail over a statute.*"

⁶³⁸ See Professor Nussberger's Expert Opinion (**Exhibit RF-03.1.C-1.3.8**), pp. 10, 28-32. Baglay's Expert Opinion (**Exhibit RF-03.1.C-1.1.1**), pp. 1-2, Avakyan's First Expert Opinion (**Exhibit RF-03.1.C-1.1.4**), § 2 and Professor Asoskov's 2017 Expert Opinion (**Exhibit RF-D5**), §§ 113-116. See in particular

Professor Avtonomov explained in his expert opinion that, in the Russian Federation, there are over 70 ministries and agencies that are able to sign treaties on their own policy areas pursuant to Articles 3 and 11 of the FLIT.⁶³⁹ If such treaties were to outrank federal legislation without any prior approval, this would undermine the primary authority of the federal legislation and the constitutional hierarchy of standards. After all, this would mean that many dozens of ministries and agencies would be able to set aside federal laws with relative ease. This would seriously infringe on the powers of both the Parliament and the President. That is obviously not the system that follows from the Russian Constitution.

(g)(v) *HVY's statement that their interpretations of the law correspond with the case law of the Constitutional Court does not hold water and was rightfully rejected by the District Court (ground 5.92)*

435. As mentioned above, the Russian Federation discussed established case law of the Russian Constitutional Court and the Russian Supreme Court from which it follows that treaties approved by the Parliament prevail over federal laws (see § 421 et seq.). HVY, however, believe that (other) judgments of the Russian Constitutional Court demonstrate that a provisionally applied treaty, such as the ECT, always prevails over federal legislation, regardless of whether it has been approved by Parliament.⁶⁴⁰ The rely in particular on Resolution 8-P of 27 March 2012.⁶⁴¹
436. The Russian Federation again states first and foremost that the question regarding the exact hierarchy of legal norms is irrelevant in this case. Indeed, Article 45 ECT provides explicitly that even a very low-ranked provision could have the effect that treaty provisions that are inconsistent with such a provision will not be applied provisionally. Accordingly, under international law, no obligations can arise that are inconsistent with national laws

Professor Avtonomov's Expert Opinion, (**Exhibit RF-D4**), § 69, which cites many authors. See also S. Pritzkow, *Das völkerrechtliche Verhältnis zwischen der EU und Russland im Energiesektor*, Springer, 2011, pp. 92, 94 et seq., (**Exhibit RF-230**) (Original German text): "Article 15 Abs. 4 S.2 VRF erzwingt im innerstaatlichen System den Vorrang eines internationalen Vertrages gegenüber einem russischen Gesetz, wenn der Vertrag "andere Regeln als die im Gesetz vorgesehenen" (innye pravila, cem predusmotrennye zakonom) vroschreibt. Genau die gleiche Formulierung findet sich in Art 15 Punkt 1 Abs. 1 lit. a) ZSM. Durch diese gleiche Wortwahl drückt sich zumindest der klare Wille des Russischen Gesetzgebers aus, dass ein internationaler Vertrag im Falle des Widerspruch zu russischen Gesetzen nur dann Vorrang genießen soll, wenn der Vertrag ratifiziert wurde."

⁶³⁹ Professor Avtonomov's Expert Opinion (**Exhibit RF-D4**), §§ 51, 93 and 106.

⁶⁴⁰ SoA, §§ 467-483.

⁶⁴¹ This resolution has been submitted as **Exhibit RF-49** and was discussed in, *inter alia*, §§ 133-134 of the SoR.

and legislation. This means that there can never be any conflict that must be solved by way of the conflict rule (in Article 15(4) of the Constitution) that stipulates that a treaty prevails over a law. This is also confirmed by the case law cited by HVY.

437. HVY's reliance on Resolution 8-P of 27 March and other, similar resolutions fails for the reasons stated below.
438. Firstly: The District Court rightfully ruled that Resolution 8-P of 27 March 2012 mainly confirms that the scope of the provisional application of the treaty can and may be limited in the treaty itself.⁶⁴² In other words: the Constitutional Court explicitly acknowledges that a treaty provision such as Article 45(1) ECT has a legal effect. This demonstrates that the question of whether Article 26 ECT should be applied can be made contingent upon national laws and even local regulations that, ordinarily, are ranked very low. Resolution 8-P therefore confirms the position of the Russian Federation. The Constitutional Court considered:

“The Russian Federation [...] may condition provisional application of an international treaty (or any part thereof) prior to its entry into force by compliance with the Constitution of the Russian Federation, laws and other regulatory acts of the Russian Federation. Agreement to provisional application of an international treaty means that it becomes part of the legal system of the Russian Federation and must be applied on the same basis as international treaties that have entered into force (unless otherwise expressly stated by the Russian Federation), since otherwise, provisional application would be meaningless.” (emphasis added)⁶⁴³

439. Secondly: the judgments cited by HVY – Resolution 8-P in particular – in no way support HVY's statement that provisionally applied treaties always have priority.⁶⁴⁴ The arguments between the parties and the assessment of that case pertained merely to the statutory/constitutional requirement that treaties must be published. Further questions regarding the scope of the exact powers of the Russian government and the Russian

⁶⁴² Judgment, ground 5.92.

⁶⁴³ Resolution No. 8-P of the Constitutional Court of the Russian Federation (27 March 2012), Section 4 (**Exhibit RF-49**). (emphasis added). English translation of the original Russian text: *"The Russian Federation [...] may condition provisional application of an international treaty (or any part thereof) prior to its entry into force by compliance with the Constitution of the Russian Federation, laws and other regulatory acts of the Russian Federation. Agreement to provisional application of an international treaty means that it becomes part of the legal system of the Russian Federation and must be applied on the same basis as international treaties that have entered into force (unless otherwise expressly stated by the Russian Federation), since otherwise, provisional application would be meaningless."*

⁶⁴⁴ SoA, §§ 467-470 and see SoD, § II.193.

Parliament were explicitly not at issue in that case.⁶⁴⁵ In Resolution 8-P, the Constitutional Court does not discuss the question of whether and under which conditions a provisionally applied treaty that deviates from federal laws enjoys priority.⁶⁴⁶ That HVY's conclusions are incorrect follows from what Mr Viatkin – on behalf of the Duma – undisputedly argued in the proceedings that led to Resolution 8-P:

“From the foregoing, we see that in the hierarchy of legal sources, a ratified treaty stands higher than a national law.”⁶⁴⁷

440. Finally: the other judgments cited by HVY also refer to the above-mentioned Resolution 8-P of the 27 March 2012. In other respects, they do not contain anything new or relevant. In none of these cases, the question was posed as to whether the provisional application of a specific treaty is in accordance with the Constitution. Therefore – and logically at that – it cannot be deduced from these judgments that a treaty applied provisionally always enjoys priority.⁶⁴⁸ For a detailed refutation of HVY's arguments, reference is made for brevity's sake to the expert report by Professor Avtonomov who goes into the specifics of both Resolution 8-P and the other judgments of the Constitutional Court.⁶⁴⁹

(g)(vi) *Treaty practice: the Russian Federation never assents to the provisional application of arbitration schemes like Article 26 ECT*

441. According to HVY, the Soviet Union and the Russian Federation agreed to provisionally apply approximately 400 treaties since 1920. They believe that this “*generally*” concerns treaties that deviate from the law and that it must be concluded from this that the

⁶⁴⁵ See Professor Avtonomov's Expert Opinion (**Exhibit RF-D4**), §§ 23-25 and 134-143, where Professor Avtonomov explains in §§ 141 and 142 that the applicable procedural rules entail that proceedings before the Constitutional Court focus only on the specific application of the law in a specific case. The Constitutional Court then assesses the case based on the appellant's complaints.

⁶⁴⁶ The Constitutional Court ruled in ground 1.2 that (English translation of the original Russian text) “*whether the provisions of the Federal Law ‘On International Treaties of the Russian Federation’ allowing for provisional application of the treaties of the Russian Federation prior to their entry into force conform to the Constitution*” had not been discussed. This case did, however, rightfully make reference to the rule of Article 23(2) FLIT, which provides for parliamentary consent to the provisional application of a treaty.

⁶⁴⁷ Professor Avtonomov's Expert Opinion (**Exhibit RF-D4**), §§ 147-149, in particular § 148 (original English text): “*From the foregoing, we see that in the hierarchy of legal sources, a ratified treaty stands higher than a national law.*” (emphasis added)

⁶⁴⁸ In SoA, §§ 471-475, HVY refer to Resolution 6-P of 19 March 2014. In SoA, §§ 476-480, they refer to Decision No. 1820-O of 18 September 2014. In SoA, §§ 481 et seq., they refer to two decisions dated 3 April 2012. In these judgments, reference is made to Resolution 8-P of 27 March 2012.

⁶⁴⁹ Expert Opinion Professor Avtonomov (**Exhibit RF-D4**), §§ 134-149.

provisional application of treaties that deviate from the law is in any event acceptable.⁶⁵⁰

This statement shows an incorrect interpretation of the law. Even if it were true that the Russian government, over a period of 100 years, very occasionally provisionally applied treaties that deviate from the law on behalf of the Russian Federation, this naturally does not say anything as to whether this was allowed under Russian constitutional law – which has been radically amended numerous times in the meanwhile. In itself, it is conceivable that the Dutch or Russian government, for instance, might at one point accidentally exceed their powers in a moment of inattention. Even if this has occurred, this of course does not mean that it is permitted.

442. The statement that the Russian Federation “*regularly*” agreed to provisionally apply treaties that deviate from the law is wrong and is in no way empirically substantiated.⁶⁵¹ In reality, the consistent treaty practice of the Russian Federation shows that arbitration schemes such as Article 26 ECT, based on which private parties may submit investment disputes with the state to arbitrators, are never applied provisionally by the Russian Federation. In other words: the Russian Federation applies a consistent treaty practice that is entirely in accordance with the positions it has taken in these proceedings.
443. HVY apparently studied all four hundred treaties ever concluded and applied provisionally. Ultimately, HVY found two treaties that contained a very limited arbitration clause.⁶⁵² This concerns two treaties in which concrete arrangements were made with two international organisations that operate as independent actors under international law (the Eurasian Development Bank and the OECD). In other words: it concerns arrangements between sovereign entities.⁶⁵³ These treaties contained conditions under which these institutions could establish offices on Russian territory. There was no general clause that supposedly allowed for arbitration between private parties and the State. As follows from the expert opinions submitted by the Russian Federation, no conclusions can be drawn, for several reasons, from these (special) treaties – the contents of which HVY have represented

⁶⁵⁰ See SoA, §§ 484-490.

⁶⁵¹ See SoA, §§ 484-490.

⁶⁵² See SoA, §§ 486, 597 and 598.

⁶⁵³ It is import to remark that a legal relationship between sovereign States cannot be considered a legal relationship under public law; see Professor Asoskov's 2017 Expert Opinion (**Exhibit RF-D5**), §§ 70-73.

wrongly or incompletely⁶⁵⁴ – as to whether the provisional application of Article 26 ECT is compatible with Russian law.⁶⁵⁵

444. Although the Russian Federation has concluded many investment treaties containing arbitration clauses over the years, the Russian Federation did never agree to the provisional application of such treaties. The Soviet Union and later the Russian Federation have for decades conducted a consistent policy in which bilateral investment treaties (i) require the approval of the Parliament and (ii) enter into force only after approval has been granted.⁶⁵⁶ This was also fully acknowledged during the Arbitrations by Mr Gladyshev, the Russian lawyer engaged as expert by HVY:

"Q. When you studied those BITs, you learned, if you didn't know before, that all those BITs required ratification, correct?

A. All those BITs required ratification and they required it as a matter of policy of the Soviet and the Russian state, that is correct.

Q. And none of those BITs has a provisional application, does it, Mr Gladyshev?

A. No, they do not. As a matter of fact they do not. That was the policy of the Russian state and the Soviet state."⁶⁵⁷

445. The Russian Federation never proceeded to provisionally apply a treaty provision that provides for arbitration between private parties, such as investors, and the Russian

⁶⁵⁴ HVY's representation is incomplete, in particular with regard to the Eurasian Development Bank. See Professor Avtonomov's Expert Opinion, (**Exhibit RF-D4**), §§ 153-167.

⁶⁵⁵ For a more elaborate description of the treaty regarding the Eurasian Development Bank, see Professor Avtonomov's Expert Opinion (**Exhibit RF-D4**), §§ 153-167. Moreover, these treaties did not contain any clause similar to Article 45 ECT. These treaties contain a limited dispute resolution provision based on which only specific disputes between the Eurasian Development Bank and the OECD with the Russian Federation can be settled by way of negotiations or arbitration. Naturally, these specific and relatively insignificant schemes in no way whatsoever compare to a general legislative arbitration provision like the one contained in Article 26 ECT. There is no such thing as an arbitration clause that enables private parties in a general sense to submit disputes to arbitrators (see Professor Asoskov's 2017 Expert Opinion (**Exhibit RF-D5**), §§ 70-73).

⁶⁵⁶ See Writ, footnote 242, Exhibit RF-48 and all 57 investment treaties mentioned there, which were all ratified without exception. See also Professor Asoskov's 2017 Expert Opinion (**Exhibit RF-D5**), §§ 127 et seq.

⁶⁵⁷ See Hearing on Jurisdiction and Admissibility, transcript dated 20 November 2008, pp. 9 et seq. (original English text: "Q. When you studied those BITs, you learned, if you didn't know before, that all those BITs required ratification, correct? A. All those BITs required ratification and they required it as a matter of policy of the Soviet and the Russian state, that is correct. Q. And none of those BITs has a provisional application, does it, Mr Gladyshev? A. No, they do not. As a matter of fact they do not, that was the policy of the Russian state and the and Soviet state."

Federation. This, too, was discussed in detail during the Arbitrations. At the time, Gladyshev had studied all 45 treaties that the Russian Federation applied provisionally at that time. At the hearing, he had to acknowledge that *none* of those treaties provides for arbitration between private parties and the State.⁶⁵⁸ The Russian Federation currently still applies dozens of treaties provisionally. None of these contain such an arbitration clause.

446. It should be noted that the treaty practice of the Russian Federation in this case, which centres on the effect of Article 45 ECT, is relevant only to a limited extent. Only very rarely does a treaty applied provisionally by the Russian Federation contain a clause that renders the scope of the provisional application dependent on Russian national law (*limitation clause*). None of the “*example treaties*” elaborated on by HVY contain such a clause.⁶⁵⁹ Such treaties will therefore provide no starting points to answer questions regarding the scope of the provisional application.

E. Discussion of the separate grounds for appeal and statements

(a) ***Introduction***

447. In this section, the Russian Federation succinctly addresses the grounds for appeal and statements formulated by HVY.⁶⁶⁰ To that end, it will – where possible – refer to the previous sections of this Defence on Appeal, from which it already follows that all of HVY’s grounds for appeal discussed there, both explicitly and implicitly, should fail. Therefore, the arguments already introduced in that context will (naturally) not be repeated here at length. They must, however, be deemed to be included.
448. It should be noted that HVY in the first chapter of their Statement of Appeal make some introductory remarks trying to suggest that this case involves an “unparalleled campaign of abuse of power, violence and intimidation”, by which the Russian Federation has showed

⁶⁵⁸ See Hearing on Jurisdiction and Admissibility, transcript dated 20 November 2008, pp. 61 et seq.: “*Q. Let's go in an orderly fashion. In fact, other than the ECT on this list of 45 treaties in attachment 2, there is no provision for resolution of any kind of dispute, investment or otherwise, between a private party and a state; correct? A. Correct, sir. (...)*” Original English text: “*Q. Let's go in an orderly fashion. In fact, other than the ECT on this list of 45 treaties in attachment 2, there is no provision for resolution of any kind of dispute, investment or otherwise, between a private party and a state; correct? A. Correct, sir. (...)*”.

⁶⁵⁹ See the five treaties mentioned in SoA, § 486.

⁶⁶⁰ SoA, §§ 605-716.

its true face to the world.⁶⁶¹ In this context, HVY adopt several positions that are irrelevant to the grounds for setting aside central to these proceedings. These allegations are no longer addressed in HVY's discussion of the grounds for appeal and apparently only serve to discredit the Russian Federation. The Russian Federation will nevertheless explain in chapter VIII that these unfounded and irrelevant reproaches are wrong.⁶⁶²

(b) ***Ground for Appeal 1: the final conclusions and operative part of the Judgment***

449. HVY assert that the conclusions and the operative part of the Judgment based on the said conclusions cannot be upheld because, briefly put, the underlying legal grounds are incorrect. According to HVY, the Tribunal did have jurisdiction because the Russian Federation was obliged to apply the ECT – and in particular Article 26 ECT – provisionally.⁶⁶³

450. Ground for Appeal 1 fails. The conclusions and operative part of the Judgment follow from the preceding legal grounds. The first ground for appeal therefore has no independent significance. As has been explained in detail above, the substantive legal grounds in the Judgment are correct (see chapter II.B-II.D above). Consequently, the conclusions that have been derived therefrom and the operative part must be maintained.

(c) ***Ground for appeal 2.1: submitted documents***

451. HVY take the position that the District Court wrongfully decided to add to the file an enormous number of exhibits that – according to HVY – were submitted late and without explanation (**Ground for Appeal 2.1**).⁶⁶⁴ According to HVY, this concerned “approximately 180 exhibits” comprising “about 40,000 pages in total”. HVY argue that they were unable to respond to these exhibits. They argue that these documents should not have been included in the case file.

⁶⁶¹ SoA, § 3.

⁶⁶² To this end, the Russian Federation in any event submits the following exhibits: United States District Court for the District of Columbia 18 August 2017, case no. 1:17-mc-01466-BAH, § 1782, at 11 (“In that litigation [Dutch proceedings between Yukos managers and Rosneft (**Exhibit RF-294**) and Mr Godfrey's Statement (**Exhibit RF-295**), a judgment of the Brussels Court dated 8 June 2017 (**Exhibit RF-296**) and a New York Times article dated 14 May 2006 (**Exhibit RF-297**).

⁶⁶³ SoA, § 609.

⁶⁶⁴ SoA, §§ 610-615.

UNOFFICIAL TRANSLATION

This text is an unofficial translation of the Dutch original. In case of any discrepancies, the Dutch original shall prevail.

452. It is correct that the Russian Federation submitted 229 exhibits approximately 2–3 weeks before the pleadings in the first instance and that these comprise over 41,000 pages. This is mostly due to the Russian Federation enclosing all source documents (most of which had already been submitted) on a USB flash drive for completion's sake. In reality, as previously asserted and not contested by HVY⁶⁶⁵, it only concerns several hundred pages of new documents. This can be explained as follows:

- (a) In total, 31 of the 229 exhibits formed the Russian share register of Yukos Oil. As majority shareholders of Yukos Oil, HVY should be familiar with this share register. The register is an annex to the expert opinion of Professor Kothari.⁶⁶⁶ Based on the share register and other documents, Professor Kothari mapped out who held which share interest in Yukos Oil at what time. Because the Russian Federation wished to be complete, it submitted the more or less complete register of 32,741 pages. This share register is extremely extensive because the shareholders of Yukos Oil tried to conceal the existence of control structures through frequently transferring shares (without there being any further economic necessity for this). It goes without saying that a register of such extent, comprising over 32,741 pages, must be 'parsed' and 'decoded'.⁶⁶⁷ The transactions must be made clear. The Russian Federation could only do so by engaging an expert, namely Professor Kothari.⁶⁶⁸ His expert opinion also includes an English translation of only the parts of the shareholders' register that Professor Kothari considered relevant to his expert opinion. This translation comprises no more than 8 pages. Disregarding the Russian text of the share register, only 8,680 of the 41,415 pages remain.

⁶⁶⁵ See Pleading Notes RF, dated 15 January 2017, §§ 66 et seq.

⁶⁶⁶ Exhibit RF-202, of which the annexes were submitted as Exhibit RF-225. See particularly annexes R-55-1 through R-55-32.

⁶⁶⁷ The Russian Federation therefore rightly argued at the hearing in the first instance that this shareholders' register was not accessible and had to be parsed and/or decoded. See also §§ 1237 et seq. below.

⁶⁶⁸ HVY for years have not disclosed the state of affairs and have deliberately concealed the group structure (see chapters III.B and III.C below). They now reproach the Russian Federation for going as far as making misstatements (see SoA, § 12). That is turning things upside down. The Russian Federation request this Court of Appeal to take cognisance of the over 32,000-page report and, on that basis, assess for itself whether this shareholders' register must be decoded/parsed.

UNOFFICIAL TRANSLATION

This text is an unofficial translation of the Dutch original. In case of any discrepancies, the Dutch original shall prevail.

- (b) The other submitted documents are also mainly annexes to the witness statements and expert opinions. Where multiple witness statements or expert opinions refer to the same exhibit, this exhibit was submitted multiple times (digitally) for completion's sake. Some documents were submitted no less than four times for that reason. 91 out of the entire set of 229 exhibits can be removed without losing any information. Moreover, many documents were submitted "twice" because a translation was also enclosed with the original. Taking into account these double counts, only 3,993 pages remain. That is not even 10% of the total number of 41,415 pages.
- (c) The total set of 229 exhibits contains 46 exhibits that had already been submitted much earlier. These documents were already part of the case file. For example, the six Yukos Awards are attached in a (digital) subfolder for the sake of completeness. These concern thousands of pages. Crossing out and correcting for previously submitted documents, only 977 pages of actually new documents remain.
- (d) Since the 977 remaining pages also include public sources of law, such as court decisions, the majority of these pages are not actually new factual documentary evidence. The actually new documents are mainly the witness statements of Anilionis and Zakharov (Exhibits RF-200-201), expert opinions of Professor Asoskov, Professor Kothari and Professor Lalive (Exhibits RF-202, 203 and 224) and some annexes not previously submitted. These concern upwards of 200 pages.

453. The above was graphically summarised – and not disputed by HVY– as follows in a pie chart at the hearing of 15 January 2017:

UNOFFICIAL TRANSLATION

This text is an unofficial translation of the Dutch original. In case of any discrepancies, the Dutch original shall prevail.

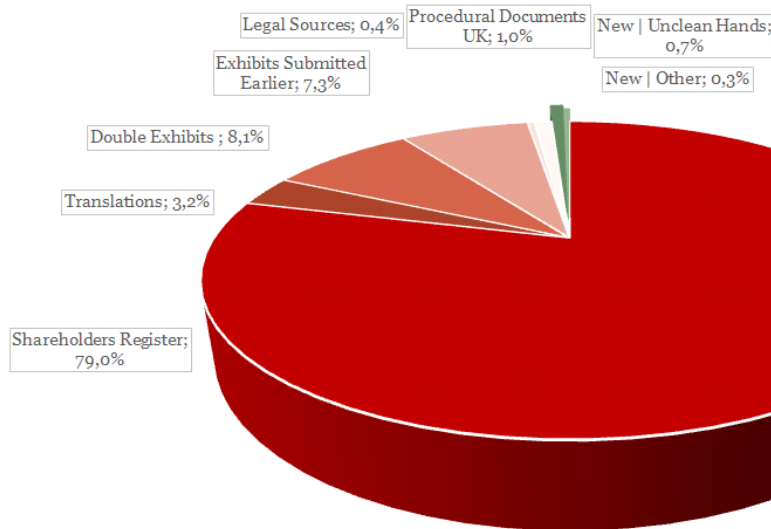

454. The documents which the Russian Federation submitted within the applicable deadlines were limited in size. HVY cannot maintain in a proper mind that they do not know what these documents are about. The new documents that pertain to several subjects and grounds for setting aside had already been submitted and explained a few months earlier in American proceedings between the parties. The Russian Federation also relied on these documents at the hearing in the first instance.⁶⁶⁹ The Russian Federation's Pleading Notes dated 9 February 2016 include dozens of references to the newly submitted exhibits. For instance, the witness statements of Anilionis and Zakharov were discussed in detail.

455. As previously discussed at the hearing of 15 January 2017, the real reason for the procedural objections was the fact that HVY wanted to keep documents unfavourable to them from the eyes of the District Court.⁶⁷⁰ The contents of Mr Anilionis's witness statement make it clear why (see also §§ 558-560 below). It should be noted that, after the attempt to convince this Court of Appeal to split these proceedings failed, HVY proved more than able to summarise and respond to some of these documents. They address these documents in §§ 821–848 of their Statement of Appeal, among other sections, whereby it

⁶⁶⁹ See also the Pleading Notes RF, dated 15 January 2017, §§ 61-63.

⁶⁷⁰ Pleading Notes RF, dated 15 January 2017, §§ 70 et seq.

should be noted that they primarily advance defences on formal grounds and that they have not advanced a substantive reply.

456. The District Court has rightly admitted the documents to the case file. If the District Court is in any way at fault⁶⁷¹ for admitting the documents, that fault has since been remedied. HVY have had more than sufficient time to study these documents that were resubmitted even before the hearing on appeal. HVY were able to respond to these documents and did exactly that. They should not be allowed to take new factual positions at a later time, in derogation from the in principle strict rule.⁶⁷²

(d) ***Ground for appeal 2.2: the burden of proof rests on HVY***

(d)(i) *Introduction*

457. HVY believe that the District Court's opinion on the division of the burden of proof is incorrect (**Ground for Appeal 2.2**).⁶⁷³ Wrongly so: it is generally accepted in case law and literature that the burden of proof rests on the party arguing that a valid arbitration agreement was concluded. This means that HVY must state and prove that the Russian Federation has expressly and unambiguously agreed to arbitration.

(d)(ii) *The fundamental right of access to the courts and the division of the burden of proof regarding the existence of an arbitration agreement*

458. In connection with the fundamental right of access to the ordinary court as described in Article 6 ECHR and Article 17 Constitution, the basic premise is that the ordinary court is competent unless there is a valid arbitration agreement. The choice for arbitration – and with it the waiver of the right of access – must therefore be made freely, voluntarily and unambiguously.⁶⁷⁴
459. In *arbitration proceedings*, it is the claimant who relies on the existence of a valid arbitration agreement. The burden of proof rests on the party that relies on (the legal effects

⁶⁷¹ The District Court promised that – should the District Court arrive at an assessment of these documents – HVY would be given the opportunity to submit another written statement.

⁶⁷² Pleading Notes RF, dated 15 January 2017, §§ 69 et seq.

⁶⁷³ SoA, §§ 616-625.

⁶⁷⁴ Meijer 2011, 3.2.3.3.

of) the existence of the agreement: the claimant in the arbitration proceedings. Professor Meijer writes:

“The rules of evidence applied by the court must also be applied by the arbitral tribunal, regardless of the decisive factor it was instructed to apply (...) In the arbitration proceedings, it is essentially the claimant, rather than the defendant, who relies on the arbitration agreement. The claimant submitting the case to the arbitral tribunal implicitly – and perhaps even explicitly – relies on the existence of an arbitration agreement.

‘The claimant initiating the arbitration proceedings thereby indicates that he assumes there is a valid arbitration arrangement.’ [footnote: Explanatory Memorandum 11, *Tijdschrift voor Arbitrage* 1984/4A, p. 38]

If the defendant then relies on the lack of an arbitration agreement, he challenges the (implicit) assertion of the claimant that an arbitration agreement exists. The defendant cannot be expected to offer proof of the challenge of the claimant’s assertion. Challenge in general does not result in a burden of proof or risk of non-persuasion. In fact, I believe it is not even necessary for the defendant to substantiate his challenge, because the challenge in itself already raises the question of whether the right of access to the court was waived voluntarily (Art. 6 ECHR and Art. 17 Constitution). As the right of access is a matter of public policy, the arbitral tribunal may demand proof of the arbitration agreement of its own motion. If the defendant challenges the claimant’s (...) assertion that an arbitration agreement exists, the claimant will have to prove the assertion in question.”⁶⁷⁵

460. In *setting aside proceedings*, the distribution of the burden of proof is no different than in arbitration.⁶⁷⁶ Given the fundamental right of access to the court (Article 6 ECHR and Article 17 Constitution) and the rationale of Article 1021 DCCP, it must be assumed that the burden of proof regarding the arbitration agreement rests on the claimant in arbitration and therefore on the defendant in the setting aside proceedings.⁶⁷⁷ The literature confirms this unanimously. Professor Meijer puts it as follows:

“Given the right of access to the court within the meaning of Art. 6 ECHR and Art. 17 Constitution and the rationale of Art. 1021 DCCP, it must be assumed that, if the claimant in the setting aside proceedings asserts that no arbitration agreement was concluded between the parties, the defendant in those setting aside proceedings will have to prove that an arbitration agreement was

⁶⁷⁵ Meijer 2011, 11.4.4.2.

⁶⁷⁶ See Professor Snijders’ Expert Opinion (**Exhibit RF-D9**), §§ 23-24: “In particular, the division of the burden of proof in the setting aside proceedings cannot be different from that in the arbitration proceedings. After all, such a difference would lead to undesirable (**[source: incongruentie?] mismatch between the decision of the Tribunal and that of the regular court on the jurisdiction of arbitrators.”

⁶⁷⁷ See also Writ, § 112.

concluded. After all, in the first instance, he relied on the assertion that an arbitration agreement was concluded.⁶⁷⁸

461. See also Professor Snijders:

“It is only logical to place the burden of proof regarding the existence of a valid arbitration agreement on the shoulders of the one relying on its validity.”⁶⁷⁹

462. In his expert opinion drawn up for the purpose of these proceedings, Professor Snijders concludes as follows:

“The burden of proof regarding the existence of an arbitration agreement as a basis for a specific arbitral award in setting aside proceedings relating to the relevant award is on the party relying on such agreement.”⁶⁸⁰

463. The setting aside proceedings are an extension of the arbitration proceedings. It therefore makes sense in this respect as well that the burden of proof regarding the arbitration agreement in setting aside proceedings still rests on the one relying on the arbitration agreement.⁶⁸¹ Professor Meijer writes:

“I believe that one has to consider this an extension of the arbitration proceedings before the arbitral tribunal. In essence, the claimant in the arbitration proceedings relies on the arbitration agreement (...). If the defendant in the arbitration proceedings then relies on the lack thereof, this should be considered a challenge of the agreement’s conclusion. Ultimately, it is then up to the claimant in the arbitration proceedings to prove the conclusion of the arbitration agreement in accordance with the provision of Art. 1021 DCCP. In the setting aside proceedings, the parties retain their original positions in this matter, as it were:

‘The defendant [in the arbitration proceedings] who denies the arbitrator’s competence to assess the dispute does not resign himself to the decision, but turns to the domestic court with the request to set aside the so-called arbitral award. This [domestic court] orders the other party [claimant in the arbitration proceedings, defendant in the proceedings to set aside the arbitral award] to prove that the basis required for arbitration – i.e. an agreement to that end between the parties – existed.’ [footnote: Nolen, p. 5] [brackets added]

⁶⁷⁸ Meijer 2011, 11.6.4.

⁶⁷⁹ Snijders, *Nederlands Arbitragerecht*, 4th print (2011), Art. 1065, annotation 2, p. 351.

⁶⁸⁰ Professor Snijders’ Expert Opinion (**Exhibit RF-D9**), § 37.

⁶⁸¹ For a recent application of the above principle, see Rotterdam District Court 18 May 2011, LJN BQ5670. See also Professor Snijders’ Expert Opinion (**Exhibit RF-D9**), §§ 24, 31, 33, 35, 37.

In the setting aside proceedings before the ordinary court, the parties essentially continue the discussion they had before the arbitral tribunal (...). The risk of non-persuasion in the matter rests on the party defending in the setting aside proceedings, as that is the party relying on the conclusion of the arbitration agreement.⁶⁸²

464. In addition, Professor Meijer rightfully remarks that Article 1021 DCCP requires a written document as proof of an arbitration agreement. This provision would be eroded if the risk of non-persuasion were to rest on the party challenging the existence of a valid arbitration agreement.⁶⁸³ Such a division of the burden of proof would go against the rationale of Article 1021 DCCP and the fundamental right of access to the court:

The risk of non-persuasion in the matter rests on the party defending in the setting aside proceedings, as that is the party relying on the conclusion of the arbitration agreement.”

If this were any different, and the risk of non-persuasion were reversed, I believe it would be easy to circumvent Art. 1021 DCCP. After all, it is possible for a defendant in the arbitration proceedings to challenge the existence of a valid arbitration agreement in time, with the claimant in the arbitration proceedings unable to prove the existence of this agreement, while the arbitral tribunal nevertheless finds itself competent. In that case, it would at the very least be curious if, in the proceedings to set aside the arbitral award on the ground that no arbitration agreement was concluded between the parties, the court no longer requires the written document within the meaning of Art. 1021 DCCP and the risk of non-persuasion regarding the lack of the arbitration agreement suddenly shifts squarely onto the defendant [*sic*; should be claimant].⁶⁸⁴ [text between brackets added]

465. In the *Offermeier/Portheine*⁶⁸⁵ ruling, the Dutch Supreme Court held that the burden of proof regarding a valid arbitration agreement in proceedings before the ordinary court rests on the party relying on the existence of the arbitration agreement:

"(...) that where the civil court is requested to rule on a dispute and where arbitrators have exclusive jurisdiction to render a decision, if parties have thus

⁶⁸² Meijer 2011, 11.6.4. See further A.I.M. Mierlo and G.J. Meijer, *WPNR* 2014 (7003) sub 2.2 (a).

⁶⁸³ See also Professor Snijders' Expert Opinion, §§ 31, 33 (**Exhibit RF-D9**): "From this point of view, too, it would be ridiculous to shift the burden of proof in respect of the arbitration agreement to the defendant in the arbitration proceedings or to the counterparty of the party invoking an arbitration agreement in setting aside proceedings."

⁶⁸⁴ Meijer 2011, 11.6.4.

⁶⁸⁵ Supreme Court 21 February 1913, *NJ* 1913, 585. HVY wrongfully assert that this ruling is supposedly outdated (SoA, § 624). This ruling is in no way outdated, which is also evident from the fact that this ruling is still cited and agreed with in case law and literature.

agreed, then the party asserting that such an agreement exists shall bear the burden of proof if the other party disputes it."

466. More recently, the Rotterdam District Court (with reference to the *Offermeier/Portheine* ruling) also confirmed that the party asserting the conclusion of a valid arbitration agreement bears the burden of proof:

"4.6 With regard to the burden of proof and obligation to furnish facts, the court finds as follows. The key question in the ground for setting aside invoked here is whether [the claimant] was rightfully involved in arbitration proceedings. If this is not the case because the parties did not agree to arbitrate disputes, the arbitral award should be set aside. The content and purport of Article 17 Constitution and Article 6 ECHR also play a part here. The basic premise is that the domestic court is competent, unless the parties agree to arbitration. In essence, Cimcool relied on this 'unless' clause, first by instituting arbitration proceedings and now by opposing the setting aside of the arbitral award. Therefore, Cimcool is the party relying on the legal effect of the asserted agreement, namely that in derogation of the main rule the arbitrator is competent instead of the domestic court. According to the standard rule of Article 150 DCCP, Cimcool bears the burden of proof and obligation to furnish facts that support this derogation. This has not changed merely because the parties have since reached the stage of setting aside proceedings (where it is [the claimant] who is requesting judgment). In this context, the setting aside proceedings should be considered no more than a vehicle to give substance to the rule just formulated before the domestic court in this concrete case.

4.7 The considerations under 4.6 are in line with the old case law of the Supreme Court, relied on by [the claimant] (ruling of 21 February 1913, *NJ* 1913, p. 585). (...)

4.8 Based on the considerations under 4.6 and 4.7, the court therefore rules that Cimcool bears the burden of proof and obligation to furnish facts regarding the existence of an arbitration agreement."⁶⁸⁶

467. Given the above (unanimous interpretations in case law and literature), the District Court correctly ruled that the burden of proof regarding the existence of a valid arbitration agreement also rests on HVY in the setting aside proceedings.

"5.4 (...) This fundamental character also entails that, in deviation from a principally restrictive assessment in reversal proceedings, the court does not restrictively assess a request for reversal of an arbitral award on the ground of a lacking valid agreement (cf. recent Supreme Court ruling of 26 September 2014, ECLI:NL:HR:2014:2837). Furthermore, in assessing such a request, the court takes as a starting point that the onus is on the defendants [HVY] to

⁶⁸⁶ Rotterdam District Court 18 May 2011, ECLI:NL:RBROT:2011:BQ5670 (*Cimcool*).

prove that the Tribunal is competent. After all, the burden of proof was also on them (as Claimants) in the Arbitration, while in the current proceedings the same jurisdiction issue is to be dealt with." (emphasis and brackets added)

(d)(iii) *HVY's assertions regarding the division of the burden of proof fail*

468. HVY believe that it is up to the Russian Federation to assert and prove that the parties did not conclude a valid arbitration agreement. They advance four arguments to that end.⁶⁸⁷
469. Firstly: HVY assert that the Russian Federation relies on the legal effects of the lack of a valid arbitration agreement and therefore bears the burden of proof pursuant to Article 150 DCCP.⁶⁸⁸ In reality, it is generally assumed that, under Article 150 DCCP, the party relying on the effects of an agreement must prove that the agreement was concluded in a legally valid manner.⁶⁸⁹
470. As set out above, the starting point is that the domestic court has jurisdiction, unless the parties agreed to arbitration. HVY rely on the "unless" clause, first by instituting arbitration proceedings – thereby relying on the existence of a valid arbitration agreement – and subsequently by opposing the setting aside of the Yukos Awards in the present proceedings. They are relying on the legal effect of the asserted arbitration agreement, namely that in derogation of the main rule the Tribunal is competent instead of the domestic court.⁶⁹⁰
471. HVY argue that the Russian Federation relies on an *exception* to Article 45(1) ECT, found in its own legal system.⁶⁹¹ This assertion is incorrect. The Russian Federation's reliance on

⁶⁸⁷ SoA, §§ 616 et seq.

⁶⁸⁸ SoA, §§ 618-620.

⁶⁸⁹ Tjong Tjin Tai, Proof of the (substance of the) agreement, *NJB* 2008/14 pp. 810-816: "The main rule of the law of evidence (Art. 150 DCCP) applies with regard to the proof of the existence of an agreement; the burden of proof rests on the party relying on the agreement to attain something." See also Supreme Court 16 January 2004, *NJ* 2004, 164 (*Badalorco/Atlanta*), ground 3.4.2: "3.4.2 Badawy based his claims on the existence of an exclusive distribution agreement between himself and Atlanta. As Atlanta has challenged the existence of this agreement with reasons, the main rule of Art. 177 (former) DCCP – presently Art. 150 DCCP – provides that Badawy bears the burden of proof regarding his assertion that an exclusive distribution agreement existed. (...)". W.D.H. Asser, Division of the Burden of Proof, Series on Civil Procedure and Practice, part 3, 2004, no. 250. See also Professor Snijders' Expert Opinion, §§ 34-35 (Exhibit RF-D9): "In accordance with the main rule of this provision [Article 150 DCCP], the party invoking the jurisdiction of a tribunal on account of the existence of an arbitration agreement, will be required to prove that the agreement exists in the event that it is contested in a reasoned and timely manner." [text between brackets has been added].

⁶⁹⁰ See also Professor Snijders' Expert Opinion, §§ 33-35 (Exhibit RF-D9).

⁶⁹¹ SoA, § 625.

Article 45(1) ECT is not an affirmative defence. Nor do Articles 26 and 45 ECT contain any further rules of the purport that a State must be assumed to consent to arbitration unless a State can successfully rely on an exception. In other words, the Treaty contains no provisions that provide for a reversal of the burden of proof. HVY rely on the provisions of Article 26 ECT. It is up to them to prove that the Russian Federation made a legally valid offer to arbitrate within the meaning of Article 26 ECT.

472. HVY furthermore argue that tribunals are free to use their discretion when applying the rules of the law and that the court can therefore apply a different division of the burden of proof in setting aside proceedings.⁶⁹² However, it is generally assumed that this rule of law does not apply to the question whether the parties have concluded an arbitration agreement in a legally valid manner.⁶⁹³ The free assessment of evidence pertains only to assertions regarding the dispute to be resolved in the arbitration proceedings, not to the question whether a valid arbitration agreement exists. An arbitral tribunal must apply the rules of evidence applied by the court regarding the existence of a valid arbitration agreement.⁶⁹⁴

⁶⁹² SoA, § 620.

⁶⁹³ The free assessment of evidence pertains only to assertions regarding the dispute to be resolved in the arbitration proceedings, not to the question whether a valid arbitration agreement exists. See for example Meijer 2011, p. 861: "*Consequently, the arbitral tribunal will in this respect have to decide whether it is competent according to the ordinary court's rules evidence. In this respect, there is an exception to the rule that the arbitral tribunal is free to use its discretion when applying the rules of evidence (Art. 1039(5) DCCP).*" See also Meijer, *T&C Rv [Text & Commentary DCCP]*, Article 1039, annotation 2. See also H.J. Snijders, *Groene Serie Rechtsvordering [Green Series on Civil Procedure]*, Article 1039, annotation 5: "*Finally, it should be noted that proof of the arbitrators' competence, which depends on an arbitration agreement, is required according to the domestic law of evidence.*". And P. Sanders, *Het Nederlandse arbitragerecht: nationaal en internationaal [Dutch arbitration law: nationally and internationally]*, 2001, p. 107: "*(...) This freedom of arbitrators does not apply in the event that a motion contesting jurisdiction is raised. In their provisional opinion on this, the arbitrators will have to consider the fact that the final opinion is reserved to the court. In that case, arbitrators will have to comply with the rules of evidence applicable to the courts, too.*"

⁶⁹⁴ Meijer 2011, 11.4.4.2: "*The question is whether the defendant in the arbitration proceedings must then prove the lack of the arbitration agreement or whether the claimant must prove its existence. The rules of evidence applied by the court must also be applied by the arbitral tribunal, regardless of the decisive factor it was instructed to apply. Nevertheless, we will see that the setting aside proceedings must in fact also take the arbitration proceedings as a starting point (...).*" Contrary to what HVY assert, this division of the burden of proof in the arbitration proceedings therefore does not change as soon as the parties are engaged in setting aside proceedings before the domestic court. See in similar sense Rotterdam District Court 11 May 2011, ECLI:NL:RBROT:2011:BQ5670 (*Cimcool*), ground 4.6, and Meijer 2011, 11.6.4: "*The defendant [in the arbitration proceedings] who denies the arbitrator's competence to assess the dispute does not resign himself to the decision, but turns to the domestic court with the request to set aside the so-called arbitral award. This [domestic court] orders the other party [claimant in the arbitration proceedings, defendant in the proceedings to set aside the arbitral award] to prove that the basis required for arbitration – i.e. an agreement to that end between the parties – existed.*" See also Professor Snijders' *Expert Opinion*, § 34 (*Exhibit RF-D9*): "*Article 1039 DCCP, which provides that the*

Therefore, the Tribunal was not free to use its discretion; the burden of proof regarding the existence of the arbitration agreement was borne by HVY at the time of the Arbitrations. Incidentally, it is only logical to apply the same division of the burden of proof in both the relevant arbitration proceedings and the setting aside proceedings. Ultimately, the ordinary court rules on the existence of a valid arbitration agreement.

473. Secondly (and thirdly): HVY assert that, in enforcement proceedings, the burden of proof is borne by the party challenging the conclusion of a valid arbitration agreement.⁶⁹⁵ Given the right of access to the court contained in Article 6 ECHR, one can rightly wonder whether this assertion is correct.⁶⁹⁶ Whatever the case may be, a claim to set aside brought before a Dutch court cannot be equated to the opposition against the recognition of or granting of leave to enforce a foreign arbitral award. (for more details, see also Professor Snijders' Expert Opinion, §§ 24-28).⁶⁹⁷ After all, the judicial assessment in proceedings for ordering enforcement has a limited range: it is not about whether the judgment should be set aside, but only whether it is enforceable and possibly whether the arbitral award can be recognized.⁶⁹⁸ The Rotterdam District Court therefore (rightfully) ruled that the questions under consideration in such proceedings are fundamentally different and that the rules on the burden of proof and obligation to furnish facts in proceedings for ordering enforcement therefore do not apply in setting aside proceedings.⁶⁹⁹ Furthermore, the applicant for leave

Tribunal offers all freedom with regard to the rules for the provision of evidence, does not apply with regard to whether an arbitration agreement exists." [emphasis and bold added].

⁶⁹⁵ SoA, §§ 621-622, with reference to Article 1(1) of the New York Convention and Article 1076(1)(a) DCCP.

⁶⁹⁶ See Meijer 2011, 11.5.3.2: "*The question is whether it is not curious that, where it concerns the conclusion of the arbitration agreement, the defendant is burdened with the proof and risk of non-persuasion of a negative fact. (...) Following Art. 1076(1) (opening lines) DCCP, requiring the submission of the original arbitration agreement or a certified copy thereof, and given the right of access to the courts established by law, I nevertheless believe that the applicant must assert and if necessary prove the conclusion of the arbitration agreement and that the applicant bears the risk of non-persuasion in this matter.*"

⁶⁹⁷ See exhibit **RF-D9**.

⁶⁹⁸ Similarly: Professor Snijders' Expert Opinion, § 24 (Exhibit RF-D9). Moreover, the individual nature of the enforcement proceedings in relation to the setting aside proceedings is well reflected in the case law on the so-called asymmetric ban on legal remedies. With regard to the latter, see the sources referred to in footnote 12 of Professor Snijders' Expert Opinion.

⁶⁹⁹ Rotterdam District Court 11 May 2011, ECLI:NL:RBROT:2011:BQ5670 (*Cimcool*), ground 4.7: "*(...) Cimcool also pointed to the provisions of Article 1076(1)(a) DCCP, on the basis of which the party opposing recognition and enforcement of a foreign arbitral award must assert and prove that a valid arbitration agreement is missing. In the court's opinion, this does not carry sufficient weight either. When it comes to the rules on recognition and enforcement of foreign arbitral awards, unlike those concerning setting aside proceedings within the meaning of Article 1065 DCCP, the question is not whether the*

to enforce must submit the arbitration agreement (and therefore provide evidence) on commencement of the proceedings for ordering enforcement, even before the court addresses the review of any grounds for refusal (see Article 1075 DCCP in conjunction with Article IV NYC and Article 1076(1) DCCP).⁷⁰⁰

474. Fourthly and lastly, HVY argue that alignment must be sought with the division of the burden of proof that applies to the other grounds under Article 1065(1) DCCP. HVY fail to recognise the specific character of the setting aside ground under Article 1065(1)(a) DCCP. The question as to the jurisdiction of the Tribunal concerns a fundamental preliminary question, being the question of whether the right of access to the domestic courts was even validly waived. This ground for setting aside – the lack of a valid arbitration agreement – is therefore fundamentally different from the other grounds for setting aside under Article 1065(1) DCCP.⁷⁰¹ This is also evident from the fact that the court – unlike with other grounds for setting aside – need not exercise restraint in assessing a claim for setting aside on account of the lack of a valid arbitration agreement.⁷⁰²

(e) ***Ground for Appeal 2.3: the viewpoint of investors***

475. HVY argue that the District Court disregarded the viewpoint of investors (**Ground for Appeal 2.3**).⁷⁰³ In §§ 311-317, it is explained that this ground for appeal lacks a factual basis. Investors could easily establish that in the Russian Federation – like elsewhere – the

arbitral award can be contested. After all, that question should be answered according to the rules of the relevant foreign country. Therefore, the question under consideration is fundamentally different in both proceedings. This means that the rules on the burden of proof and obligation to furnish facts of Article 1076 DCCP cannot be considered applicable to Article 1065 DCCP."

⁷⁰⁰ See also Professor Snijders' Expert Opinion, §§ 26-28 (**Exhibit RF-D9**).

⁷⁰¹ Snijders 2011, Article 1065, annotation 2. Along the same lines, see: Rotterdam District Court 18 May 2011, ECLI:NL:RBROT:2011:BQ5670 (*Cimcool*), grounds 4.5 and 4.7: "The Supreme Court ruling of 23 April 2010 (*RvdW 2010, 560*) that *Cimcool* relied on in defence does not change this [division of the burden of proof]. That ruling deals with the division of the burden of proof in a case where the setting aside of an arbitral award was invoked on the ground that the arbitrator did not comply with his mandate (Article 1065(1)(c) DCCP). As discussed under 4.5 above, such a ground for setting aside is fundamentally different from the present ground for setting aside [ground a – the lack of a valid arbitration agreement]. Indeed, in case of setting aside on ground c, the jurisdiction of the arbitrator is not in dispute as such and, consequently, neither is the exclusion of the domestic court."

⁷⁰² Supreme Court 26 September 2014, ECLI:NL:HR:2014:2837, *NJ 2015/318 (Ecuador/Chevron)* and The Hague Court of Appeal 17 March 2015, ECLI:NL:GHSHE:2015:929, ground 3.3.7 and Rotterdam District Court 18 May 2011, ECLI:NL:RBROT:2011:BQ5670 (*Cimcool*), ground 4.5. Meijer in *T&C Rv [Text & Commentary DCCP]*, Article 1065, annotation 1b, and H.J. Snijders, *Nederlands Arbitragerecht [Dutch arbitration law]*, 4th print (2011), Article 1065, annotation 2.

⁷⁰³ SoA, §§ 626-630.

arbitration of public-law tax and expropriation disputes is not permitted. Investors could and should have realised without too much effort that the Russian Federation would not apply Article 26 ECT provisionally.

476. The District Court most certainly did consider the interests of investors. It also included HVY's various arguments on transparency in the assessment (see §§ 296–304 above). It has discussed the principles of transparency and reciprocity. However, these principles did not play a decisive role in the formation of the wording of Article 45(1) ECT (see § 82 and 296 above). The District Court therefore rightly held that the own policy considerations regarding transparency and reciprocity cannot entail that an obligation that is not included in the wording of the treaty must be accepted.
477. In this context, the Russian Federation does however want to clarify that HVY only speak of problems “investors” in general might have with regard to taking note of Russian law. Be that as it may: such problems were not at issue here. HVY are letterbox companies which were in fact controlled by the Russian Oligarchs. These Russian Oligarchs and their internal and external legal and tax advisors were very much familiar with Russian law. The Oligarchs Dubov and Lebedev were even members of the Russian Parliament, in which capacity they were in part responsible for the formation of the legislation that is central to these proceedings.

(f) *Ground for appeal 3: the reliance on acquiescence and estoppel*

478. With **Ground for appeal 3**, HVY take the position that the Russian Federation should not be allowed to take the position that the provisional application of Article 45 ECT is inconsistent with Russian law. For this purpose, they invoke the principles of acquiescence and estoppel under international law in particular.⁷⁰⁴ The Tribunal has already rejected this reliance. In § 305 et seq. of this Defence on Appeal, it is explained in detail that the reliance on acquiescence and estoppel fails on several, (partly formal⁷⁰⁵) grounds. One of the reasons for this is that there is no factual basis for such an argument. The Russian Federation has consistently taken the view that (i) it applies the Treaty only in so far as it is

⁷⁰⁴ SoA, § 631.

⁷⁰⁵ For example, it has been indicated that the defendant is not allowed in setting aside proceedings to challenge the Tribunal's rejection of an alternative ground of jurisdiction put forward by the defendant as a claimant in the arbitration proceedings (see §§ 257-267 and 268-277 above). It was also explained that the principles of acquiescence and estoppel under international law do not apply in proceedings governed by Dutch civil procedural law.

not contrary to Russian law and (ii) arbitration on expropriation and tax disputes if it is contrary to Russian law.

(g) ***Ground for appeal 4: the interpretation of Article 45 ECT***

479. With **Ground for Appeal 4**, HVY challenge the assessment of the District Court that relates to the interpretation of Article 45 ECT. In their **core ground for appeal 4.1**,⁷⁰⁶ HVY summarise their grievances:

- (a) According to HVY, States which have signed the ECT should provisionally apply the Treaty in its entirety, unless they have issued an opt-out declaration pursuant to Article 45(2) ECT. This ground for appeal cannot be dealt with in these proceedings (see §§ 257-267 above and ground for appeal 4.2 below). Moreover, this ground for appeal fails on substantive grounds. The Tribunal and the District Court have legitimately rejected this argument. Article 45(1) ECT and Article 45(2) ECT provide for two separate regimes. The Russian Federation was in no way obliged to provide an opt-out declaration in order to invoke the Limitation Clause in Article 45(1) ECT (see, in particular, §§ 257-267 and 285-295 above).
- (a) HVY argue that Article 45 ECT refers to the question of whether provisional application as such is allowed. As explained in §§ 63-140, this ground for appeal fails. The District Court concluded that Article 45 ECT demonstrates that only treaty provisions that are compatible with Russian law must be provisionally applied (see § 63 et seq.). This interpretation by the District Court is in line with what the States envisaged during the negotiations. The District Court's interpretation is entirely in line with that of the Netherlands, the European Union and all its (then) member states, representatives of, *inter alia*, the United States, Finland and Japan, the parties involved in the negotiations on the ECT and the legal opinions expressed in the literature. (see § 106 et seq. above).
- (b) In these appeal proceedings, HVY advocate an entirely new interpretation regarding the words “*not inconsistent with*”. They argue that the Treaty

⁷⁰⁶ SoA, §§ 632-635.

allegedly requires that there is “undeniable” inconsistency with a specific and explicit rule in national law. This relates to an issue never discussed before and on which the Tribunal rightly did not express an opinion. These new arguments cannot be discussed for the first time in setting aside proceedings (see the discussion of ground for appeal 4.2 and §§ 257-267 and 268-279 above). In addition, the grounds for appeal also fail on substantive grounds. After all, the Treaty does not require that there is “undeniable” inconsistency with a concrete mandatory or prohibitory provision (see §§ 371 - 384 above). The opinion of the District Court with regard to this issue is correct as well and is in no way inherently contradictory.⁷⁰⁷

480. In **Ground for appeal 4.2**, HVY argue that there is allegedly room in the setting aside proceedings to reassess the grounds of jurisdiction that were expressly rejected by the Tribunal.⁷⁰⁸ They fail to recognise that the legal system entails that a “negative decision on jurisdiction” cannot be challenged (see §§ 257-267 and 268-277 above and Professor Snijders’ Expert Opinion (**Exhibit RF-D9**)).
481. With **Ground for appeal 4.3**, HVY argue that the District Court erred in its assessment of the object and purpose of the ECT, the nature of international law and the grounds of the Tribunal based thereon.⁷⁰⁹ As explained in §§ 78-79 and 365 - 370, among others, the District Court rejected the arguments advanced by HVY in this context in a substantiated manner.
482. In **Ground for appeal 4.4**, HVY argue that the District Court has incorrectly disregarded the *travaux préparatoires* in its interpretation of the “to the extent” provision of Article 45 ECT.⁷¹⁰ The Russian Federation states first and foremost that the text of Article 45 ECT already demonstrates that the District Court’s interpretation is correct. For that reason, the District Court could disregard the *travaux préparatoires* (see §§ 63 and 84 above). The

⁷⁰⁷ It concerns a completely correct and understandable explanation by the District Court of the words “not inconsistent with its constitution, laws or regulations”. The fact that the District Court uses different words such as “inconsistency” and “compatibility” for the sake of brevity does not make its standpoint incorrect or inconsistent. The District Court nota bene explicitly states in ground 5.33 that these words are intended to have the same meaning.

⁷⁰⁸ SoA, §§ 636-643.

⁷⁰⁹ SoA, §§ 644-646.

⁷¹⁰ SoA, §§ 647-649.

District Court held superfluously that its interpretation is supported by the *travaux préparatoires*. This last ruling is correct and is confirmed by additional documents that relate to the formation of Article 45 ECT (see §§ 84 - 100 above).

483. In **Ground for appeal 4.5**, HVY argue that a comment made Mr Bamberger during the plenary negotiations about the ECT does not support the interpretation of the District Court.⁷¹¹ This standpoint is incorrect (see §§ 130 - 134 above). Mr Bamberger's relevant comment confirms - like all other documents that relate to the formation of Article 45 ECT - the correctness of the District Court's interpretation. It is telling that HVY – who engaged Mr Bamberger as an expert for a fee at the time of the Arbitrations – have never submitted any statement or opinion by Mr Bamberger. As a result, it was not possible for the Russian Federation to summon him as a witness or to engage him as an expert.⁷¹² HVY again fails to submit a witness statement or expert opinion in these appeal proceedings (see §§ 130 et seq. above).
484. With **Ground for appeal 4.6**, HVY take the position that the District Court does not substantiate its interpretation of the words “not consistent with”.⁷¹³ This ground for appeal also fails. The assessment made by the District Court has been properly and correctly substantiated in light of the arguments between the parties (see ground 5.33 and §§ 376-377 above). After all, the parties did not debate the words “*not inconsistent with*” in the Arbitrations nor in the first instance. It was not until their Statement of Appeal that HVY submitted that these words allegedly demonstrate that there must be “*undeniable inconsistency*” with a specific and explicit statutory provision (see, *inter alia*, §§ 374, 375 and 378 above). They therefore advanced a new argument which the District Court could not even take into account in its reasoning. Moreover, the District Court was not obliged to explain the correct interpretation of a rule of law. The obligation to state reasons relates only to pure or mixed factual decisions.
485. With **Ground for appeal 4.7** HVY challenge ground 5.33 of the District Court's Judgment.⁷¹⁴ In this consideration, the District Court discusses HVY's casual statement (to

⁷¹¹ SoA, §§ 650-651.

⁷¹² Writ § 183, SoR §§ 107-109.

⁷¹³ SoA, §§ 652-653.

⁷¹⁴ SoA, §§ 654-659.

wit, worked out in detail in the Rejoinder) that a specific prohibitory provision must be specified which demonstrates that arbitration based on Article 26 ECT is prohibited. The District Court has rightly rejected this casual and late⁷¹⁵ interpretation as being too restrictive. Article 45 ECT merely requires that the provisional application of Article 45 “*is inconsistent with*” the Russian “*constitution, laws or regulations*”. The grounds for appeal that have been directed against this are either incorrect or based on an incorrect interpretation of the Judgment (see §§ 372, 376 - 377 above).

486. It is important to determine explicitly that in Ground for appeal 4.7 HVY do not advance any complaints against the rejection of their argument that Article 45 ECT requires that a specific prohibitory provision must be identified. The District Court's opinion that such an interpretation is too limited and does not ensue from the text of Article 45 ECT is thus correctly established as undisputed (see §§ 376-377). For the sake of completeness, the full consideration of the District Court is given once again below whereby the considerations that are undisputed by HVY have been underlined:

“5.33. Against this backdrop, the court will now assess whether the provisional application of the arbitral provision of Article 26 ECT is in accordance with the Russian Constitution, laws or other regulations. In this context, the court states the following first and foremost. In the view of the defendants, a provision of the ECT, such as Article 26, can only be incompatible with Russian law if the Treaty provision concerned is prohibited in national law. They believe that there cannot be incompatibility if Russian law does not expressly provide for the treaty provision concerned. The court holds that the defendants’ interpretation is too limited. Leaving aside the fact that a linguistic interpretation of Article 45 ECT does not yield a basis for such an interpretation, it is also not evident. *Given in part the fact that the provisional application finds its legitimacy in the signing (and the sovereignty of the Signatories is at stake in a number of treaty provisions), the provisional application of the arbitral provision contained in Article 26 is also contrary to Russian law if there is no legal basis for such a method of dispute settlement, or – when viewed in a wider perspective – if it does not harmonise with the legal system or is irreconcilable with the starting points and principles that have been laid down in or can be derived from legislation.* Whenever the court for the sake of brevity uses ‘compatibility’ of the provisions of the ECT with Russian laws below, the court refers to this interpretation of the term ‘not inconsistent’ in Article 45 paragraph 1 ECT.” (emphasis added)

487. The italicised sentence in ground 5.33 specifically concerns the Russian legal system. The District Court already touches upon – in that italicised sentence – what is further explained

⁷¹⁵ The comment is late because – as explained multiple times above – no entirely new arguments can be raised in setting aside proceedings.

later in the Judgment in the discussion on Russian law. In ground 5.35 the District Court further elaborates that federal legislation demonstrates that arbitration on public-law disputes is not allowed. Subsequently, the District Court explains in detail that the Laws on Foreign Investments do not include a deviating arrangement. They do not provide for a “*legal basis*” or “*legal ground*” that entails that arbitration about investment disputes is possible by way of exception (grounds 5.64 and 5.65). As explained in § 207 et seq. above, this opinion is correct.

488. HVY deem the Judgment of the District Court “*to be very unclear*” and in Ground for appeal 4.7 they challenge all kinds of far-reaching interpretations of what they believe “*seem*” to follow from the sentence in ground 5.33 shown in italics above.⁷¹⁶ They presume that the District Court explains Article 45 ECT in this italicized sentence. They interpret the opinion of the District Court in such a way that the District Court allegedly held that “*there is only a ‘law’ if it is explicitly laid down in legislation*”.⁷¹⁷ They are also of the opinion that the District Court could have intended that the interpretation of Article 45 ECT differs “*for the different provisions of the ECT*”.⁷¹⁸ They furthermore believe that, in the interpretation of Article 45 ECT, the District Court chose an interpretation “*that differs from the literal and manifest meaning*” because this is what state sovereignty entails.⁷¹⁹ All these interpretations of the Judgment are incorrect. HVY contest legal interpretations that the District Court has never honoured. They challenge a self-designed caricature that has little to do with both the arguments between the parties in the first instance and the actual content of the District Court's Judgment. Ground for appeal 4.7 fails for this reason.

(h) ***Ground for appeal 5: inconsistency with Russian constitutional law***

489. According to **Ground for appeal 5.1**, provisional application of the ECT was and is “*not inconsistent with*” Russian law.⁷²⁰ This ground for appeal fails. Arbitration of HVY’s claims is contrary to Russian law on account of (at least three) self-supporting grounds (see §§ 141-251 above). For example, HVY have not really – let alone substantively – disputed that Russian law does not allow shareholders such as HVY to bring a (derivative) legal

⁷¹⁶ SoA §§ 656 and 657 (see, to a certain extent, also SoA §§ 407 and 413).

⁷¹⁷ SoA, § 656.

⁷¹⁸ SoA, § 657.

⁷¹⁹ SoA, §§ 658 and 659.

⁷²⁰ SoA, § 660.

claim on account of damage caused to the Yukos Oil company (see §§ 242-250 above).
The fifth ground for appeal can be rejected on the basis of that argument alone.

490. In Grounds for appeal 5.2 and 5.4, HVY argue that, in establishing Russian constitutional law, the District Court wrongly disregarded the arguments and evidence advanced by HVY.⁷²¹ Supposedly, the District Court “unquestioningly” adopted the Russian Federation’s assertions.

491. HVY first of all believe that the District Court did not address the expert reports submitted by Mr Gladyshev. Reportedly, the District Court referred to his first expert report only once to “*subsequently completely disregard it*”.⁷²² This ground for appeal fails.

- (a) The Russian Federation states first and foremost that Mr Gladyshev is not an expert. Mr Gladyshev has no particular expertise in terms of Russian constitutional law. He has not written any books and articles about the Russian Constitution. Nor has he held an academic position in that regard.⁷²³ By his own admission, Mr Gladyshev has been involved as an actual lawyer in several Yukos cases since 2004.⁷²⁴ In 2011, he started working for the law firm of Canadian lawyer Robert Amsterdam, who has been Mr Khodorkovsky’s personal lawyer for many years.
- (b) Even though the District Court was not obliged to give reasons for its interpretation of a particular rule of law, the District Court discussed Gladyshev's reports. HVY’s assertion that the District Court refers only briefly to Gladyshev’s report in grounds 5.79 and 5.89 to “*subsequently completely disregard*” is incorrect.⁷²⁵ HVY have not read the District Court’s Judgment properly, as, in the subsequent grounds, the District Court explains in detail why it rejects Gladyshev’s legal positions (grounds 5.90-

⁷²¹ SoA, §§ 661-664.

⁷²² SoA, § 661.

⁷²³ Gladyshev was heard during the Arbitrations. The lawyer of the Russian Federation asked many questions on that occasion to find out on what basis Gladyshev believed he was an expert. See hearing transcript dated 20 November 2008, pp. 15-35. The transcript demonstrates, for example, that Gladyshev never held an academic position and has not published even a word about the provisional application of treaties.

⁷²⁴ Gladyshev stated that he submitted his opinion as a “*professional lawyer*”, see hearing transcript dated 20 November 2008, p. 4, 17. See also R-892.

⁷²⁵ SoA, § 661 and footnote 469.

5.92). The District Court referred in that respect to, among other things, the expert opinion by Professor Angelika Nussberger, who was the director of the University of Cologne's Institute of Eastern European Law at the time.⁷²⁶ Therefore, the District Court set aside Gladyshev's positions in a reasoned manner on substantive grounds.

492. Second, HVY argue that the District Court failed to acknowledge that it should take account of the arguments of both parties.⁷²⁷ This complaint is unsuccessful: the District Court did discuss HVY's positions and arguments. This is not changed by the fact that the District Court rejected these arguments and positions. It is striking that HVY manage to give only one example of an argument that supposedly was not considered by the District Court. In their opinion, the District Court *unquestioningly* adopted the position of the Russian Federation that Article 23(2) FLIT has retroactive force by virtue of a presidential instruction. They make reference to their arguments in SoD §§ I.65-67, II.220-228 and Rejoinder §§ 95-104. In the said written submissions, however, HVY did not dispute the Russian Federation's argument that Article 23(2) FLIT applied with retroactive force. The District Court therefore rightfully used this statement as an undisputed basis for its decision. Reality is that HVY are prevaricating: their previous 'expert' Gladyshev believed that Article 23 FLIT was indeed applicable. After they took note of the District Court's decision, they engaged new experts (Dr Mishina and Professor Stephan) and reviewed their position for reasons of judicial efficiency. They now believe that Article 23 FLIT does not apply (see §§ 390-396 above). This change of course fails on the basis of the provisions of Article 154 DCCP alone.

493. Third, HVY complain that the District Court failed to acknowledge that it is difficult for HVY to approach an expert – residing in the Russian Federation – to subscribe to their position.⁷²⁸ This complaint lacks all legal relevance. Furthermore, they do not explain the complaint in any way whatsoever. Presumably, a number of professors, which were approached by HVY, indicated that they do not agree with HVY's positions. This would not be surprising, given that the predominant view of many renowned professors in their

⁷²⁶ She is presently the vice-president of the European Court of Human Rights. The Russian Federation considered it inopportune to approach an ECtHR judge to prepare a (new) expert opinion.

⁷²⁷ SoA, §§ 661, 663 and 664.

⁷²⁸ SoA, § 662.

written publications is incompatible with the anomalous legal interpretations of Russian law advanced by HVY. Be that as it may, the various Yukos companies have never been deprived of adequate legal assistance in terms of Russian law. Over the years, they have engaged many Russian lawyers and experts, among whom, Messrs Kovalev, Gladyshev, Holiner and Maggs. They even engaged two new experts on appeal in these setting aside proceedings: Professor Stephan and Dr Mishina.

494. Fourth, HVY complain that the District Court failed to acknowledge that “*the expert opinions submitted to the court by the Russian Federation should be considered with the utmost caution*”, in view of the considerable interests at stake here.⁷²⁹ The Russian Federation cannot advance a defence against accusations that are not further substantiated. HVY do not explain, for instance, why the expert opinion by Professor Angelika Nussberger (currently vice president at the European Court of Human Rights) cited by the District Court in the parts of the Judgment relevant in this light, should be considered with caution. The Russian Federation merely asserts that its experts have an excellent professional reputation and performed their activities in good faith.
495. In **Ground for Appeal 5.3**, HVY assert that the District Court's assessment is incomprehensible and “*inherently inconsistent*”.⁷³⁰ They find that the District Court concludes that the arbitration clause of Article 26 ECT is inconsistent with Russian statutory provisions that prescribe that only civil-law disputes are arbitral (ground 5.65). HVY rightfully believe that this should be the end to the matter. In other words: this opinion is sufficient to support the conclusion that arbitration on this dispute is inconsistent with Russian law. In grounds 5.66-5.94, the District Court goes on to discuss – superfluously – that the provisional application of Article 26 ECT is inconsistent with the principle of the separation of powers laid down in the constitution. This opinion is not incomprehensible, nor is it inconsistent with the District Court's previous assessment. The District Court simply bases its conclusion on a second opinion that independently supports its reasoning, addressing the arguments advanced in the proceedings (see, *inter alia*, §§ 39 and 151 above).

⁷²⁹ SoA, § 662.

⁷³⁰ SoA, § 665.

496. In **Ground for Appeal 5.4**, HVY assert that the District Court based its decision regarding the separation of powers on sources that cannot support its findings.⁷³¹ As explained in detail in §§ 155 - 181 and 387 - 446, this position is wrong. The Russian Constitution and Russian laws limit the power of the Russian government to provisionally apply treaties without the consent of the Federal Parliament. For that reason, arbitration of the legal claims brought by HVY on the basis of Articles 26 and 45 ECT is inconsistent with Russian law. The ground for appeal fails.

- (a) HVY argue that the District Court ruled that each treaty should be ratified.⁷³² They contest a position that was never held by the District Court. In the ground referred to by HVY – ground 5.84 – the District Court clearly attached additional clauses to its opinion and limited its opinion to treaties that deviate from or that supplement federal laws. This opinion is entirely in line with Russian legislation (see, *inter alia*, §§ 167 and 168 above).
- (b) HVY complain that the District Court did not take their arguments into account and adopted the positions of the Russian Federation without question.⁷³³ In this context, they mostly discuss the fact that the District Court relied on Resolution No. 8 of the Russian Supreme Court of 31 October 1995, Resolution No. 5 of the Russian Supreme Court of 10 October 2003 and Decision 2531-O of the Constitutional Court of 6 November 2014.⁷³⁴ In its Reply, the Russian Federation made reference to these decisions and also submitted a translation thereof.⁷³⁵ HVY did not say a word about these decisions in their Rejoinder. They did not advance a defence. They now argue that the District Court has not independently assessed these decisions that were submitted to the court.⁷³⁶ This reproach is unfounded and uncalled for. The District Court inspected the relevant decisions and rightly considered these in its assessment. As discussed in detail above, these decisions are relevant (see § 424 above). The District

⁷³¹ SoA, §§ 666-682.

⁷³² SoA, § 667.

⁷³³ SoA, § 669.

⁷³⁴ Judgment, ground 5.91, with reference to SoR, § 135.

⁷³⁵ SoR, § 135, (**Exhibits RF-122, RF-123 and RF-124**).

⁷³⁶ SoA, §§ 668 and 671.

Court's interpretation of these decisions is entirely in line with later decisions and the literature published in this light. As Professor Avtonomov explains in more detail in his expert opinion, the arguments to the contrary now raised by HVY should be disregarded.⁷³⁷

- (c) HVY complain that the District Court copied the positions of the Russian Federation's experts "without question".⁷³⁸ In that context, they argue – rightfully so – that the District Court attached significance to the expert opinions that were submitted to the court by the Russian Federation. They believe that these expert opinions are based on a confusion of the regime of provisional application with the regime of entry into force of treaties. This criticism does not hold water, as is evident from §§ 155-181 and 387-446 above. The Russian Federation constantly emphasised the distinction between entry into force and provisional application. In reality, HVY confused this issue in the first instance by wrongfully referring to the Russian Federation as a "Contracting State" at least 123 times in 55 sections of the Statement of Defence, making it appear as though the Treaty had entered into force for the Russian Federation.⁷³⁹

(i) ***Ground for appeal 6: inconsistency with the statutory provision on arbitrability***

497. According to **Ground for Appeal 6.1**, Russian law allows for disputes pursuant to Article 26 ECT to be settled by arbitration. This ground for appeal is unsuccessful on the grounds that are discussed above in §§ 141-179. Disputes relating to expropriation, taxes, execution and bankruptcy are not arbitrable under Russian law. In other words: if a dispute pertains to the exercise of powers under public law (*jure imperii*), it must be submitted to the domestic court - regardless of the exact basis of the claim⁷⁴⁰. Russian law does not have a statutory provision based on which this would be different for disputes between an – alleged – foreign investor and the State.

⁷³⁷ SoA, §§ 672-676. Expert Opinion Professor Avtonomov (**Exhibit RF-D4**), §§ 134-146.

⁷³⁸ See SoA, § 669.

⁷³⁹ See SoR, §§ 48, 55. HVY alleged that the Russian Federation is a Contracting State. This is incorrect, which they seem to have acknowledged in SoRej., footnote 34.

⁷⁴⁰ See § 191 above, where it is explained that a non-arbitrable public-law dispute does not suddenly change colour just because the claimant bases its claim on, for instance, Article 13 ECT or Article 1 FP-EHCR.

498. In **Ground for Appeal 6.2**, HVY take the position that the District Court's considerations regarding the Russian Laws on Foreign Investments are wrong. It was explained in §§ 201-241 that the District Court's ruling is correct. These laws do not provide any independent statutory ground based on which this dispute can be submitted to arbitrators – which HVY's expert was also compelled to acknowledge. Accordingly, these laws do not contain any exceptions to the rule enshrined in the law that tax disputes and (alleged) expropriation disputes are not arbitrable.
499. In **Ground for Appeal 6.3**, HVY argue that the District Court's considerations concerning the Explanatory Memorandum accompanying the act to ratify the ECT, which was drawn up by the government at the time, are wrong. This ground for appeal fails. The Explanatory Memorandum is not explicitly aimed at the question on whether Article 26 ECT is consistent with Russian law. The Explanatory Memorandum does confirm that the ECT sets rules that deviate from existing legislation (see § 321 above). The memorandum shows that the Treaty would require further implementation legislation in various areas. HVY's assertion that the government supposedly concluded that all treaty provisions were always consistent with Russian law even without approval or ratification is incorrect.⁷⁴¹ This position was refuted extensively in the first instance and was rightfully rejected by the District Court.⁷⁴² As explained above in §§ 318-335, representatives of the Russian Federation made it clear during the negotiations, as well as several times thereafter, that the ECT contains treaty provisions that are inconsistent with Russian law. In addition, the District Court – rightly – remarked that the relevant legislative proposal of the government has not been ratified by the Parliament.

(j) ***Defence against HVY's expert opinions***

500. In the previous chapters, the Russian Federation discussed HVY's assertions, also to the extent that these make reference to experts. A separate discussion of the expert opinions submitted by them is therefore not needed. For that reason, the Russian Federation limits itself to some brief comments further to the opinions submitted.

⁷⁴¹ See SoA, §§ 170-173, 704-710 and SoD, §§ II.202-204 and SoRej., §§ 83-88.

⁷⁴² See also SoR, §§ 117-128. See also in more detail: Professor Asoskov's 2017 Expert Opinion (**Exhibit RF-D5**), §§ 135-142.

501. The expert opinions of Professor Nico Schrijver and Professor Jan Klabbers partly pertain to the interpretation of Article 45 ECT.⁷⁴³ Their interpretation of this treaty provision was refuted in §§ 52-140 and 296-304 above. For a more detailed refutation of the assertions in their opinion, the Russian Federation refers to the expert opinions by Professor Alain Pellet⁷⁴⁴ (to the extent that it concerns the interpretation of Article 45 ECT), Professor Heringa⁷⁴⁵ (to the extent that it concerns the standpoint of the Netherlands), and the many expert opinions submitted during the Arbitrations. The expert opinions by Professor N. Schrijver and Professor J. Klabbers also pertain to acquiescence and estoppel under international law. These parts of their expert opinions were mainly refuted in §§ 305-384 above. In addition, the Russian Federation refers to Professor Georg Nolte's expert opinion.⁷⁴⁶
502. HVY submitted an expert opinion by Dr Ekaterina Mishina. She is not an independent expert. It follows from the introduction to the expert opinion that she was employed – and might still be employed⁷⁴⁷ – by the Institute for Modern Russia (“IMR”). The IMR is managed by Pavel Khodorkovsky, the son of Mikhael Khodorkovsky, and is affiliated with the Open Russia organisation. The IMR is financed by the Russian Oligarchs.⁷⁴⁸ The contents of her expert opinion were refuted in §§ 155-181 and 387-446. For a more detailed refutation, the Russian Federation refers in particular to the opinions by Professor Avtonomov, Professor Nussberger and Professor Avakian.⁷⁴⁹
503. HVY furthermore submitted an expert opinion by Professor Stephan. The contents of his opinion were refuted particularly in §§ 155-241 and 387-446 above. For a more detailed refutation, the Russian Federation refers in particular to the expert opinions by Professor

⁷⁴³ It should be noted that large parts of these opinions were irrelevant because they address the obligations of States after they have ratified a treaty.

⁷⁴⁴ Professor Pellet's 2017 Expert Opinion (**Exhibit RF-D3**).

⁷⁴⁵ Professor Heringa's Expert Opinion (**Exhibit RF-D1**).

⁷⁴⁶ Professor Nolte's 2017 Expert Opinion (**Exhibit RF-D2**).

⁷⁴⁷ Dr Mishina's most recent contribution to the IMR's website is dated November 2016.

⁷⁴⁸ According to the journalist Lucy Komisar, the PR advisers of Khodorkovsky played a crucial role in the incorporation of various beautifully and nobly named organisation. See Lucy Komisar, *Yukos Kingpin on Trial*, CorpWatch (10 May 2005) (RME-121).

⁷⁴⁹ See Professor Avtonomov's Expert Opinion, (**Exhibit RF-D4**). The expert opinionx by Professor Nussberger (**Exhibit RF-03.1.C-1.3.8**) and Avakian (Avakyian's First Expert Opinion, **Exhibit RF-03.1.C-1.1.4** and Avakyian's Second Expert Opinion, **Exhibit RF-03.1.C-1.3.1**) have already been submitted in the Arbitrations.

UNOFFICIAL TRANSLATION

This text is an unofficial translation of the Dutch original. In case of any discrepancies, the Dutch original shall prevail.

Asoskov, Professor Avtonomov, Professor Marochkin, Professor Nussberger and Professor Avakian.⁷⁵⁰

⁷⁵⁰ See Professor Asoskov's 2017 Expert Opinion, (**Exhibit RF-D5**), Professor Avtonomov's Expert Opinion, (**Exhibit RF-D4**) and Professor Marochkin's Expert Opinion, (**Exhibit RF-D6**). The expert opinionx by Professor Nussberger (**Exhibit RF-03.1.C-1.3.8**) and Avakian (Avakyian's First Expert Opinion, **Exhibit RF-03.1.C-1.1.4** and Avakyian's Second Expert Opinion, **Exhibit RF-03.1.C-1.3.1**) have already been submitted in the Arbitrations.

III. BACKGROUND: THE UNLAWFUL ACQUISITION, EXPLOITATION, AND LOOTING OF YUKOS OIL COMPANY

The Russian Federation refers to:		
Arbitrations:		
Final Awards	Chapter IX.B	marginals 1283-1310 (see also marginals 272-502 and 1616-1621)
Setting aside proceedings:		
Writ	Chapter II.A	§§ 30-60
SoD	-	-
SoR	Chapter II	§§ 26-33
SoRej	-	-
RF Pleading Notes	-	-
HVY Pleading Notes	-	-
SoA	Chapter 13	§§ 805-851

Primary exhibits:	
Arbitrations:	
Exhibit RF-03.1.C.-2.2.5	Kraakman Expert Opinion
Annex (Merits) C-1240	Agreement dated 1 November 2002
RME-3584	Statement of Ivanenko
RME-18	Statement of Miller
-	Expert Opinion of prof. Van Weeghel 2007
-	Expert Opinion of prof. Rosenbloom 2011
RME-3328	First ECtHR ruling
Setting aside proceedings:	
Exhibit RF-D13	Expert Opinion of prof. Pieth januari 2017
Exhibit RF-C2	Expert Opinion of Gololobov
Exhibit RF-C3	Expert Opinion of Jevgeny Rybin
Exhibit RF-307	Article in Forbes dated 1 April 2015
Exhibit RF-200	Expert Opinion of Mr. Anilionis
Exhibit RF-300	Expert Opinion of Mr. Golubovich

Essence of the reasoning

This dispute between the Russian Federation and Russian Oligarchs concerns a wide range of illegal activities by these Russian Oligarchs.

- The Russian Oligarchs (also through YUL) used fraud, bribery, collusion and conspiracy to acquire majority control of Yukos in 1995 and 1996.
- Hulley and VPL are incorporated for the purpose of evading dividend taxes in the Russian Federation. For that purpose, HVY abused the Russia-Cyprus DTA.
- The Russian Oligarchs used shells for the abuse of tax rules in the Russian Federation's low-tax regions.
- After their tax frauds were discovered, the Russian Oligarchs and HVY took

measures to obstruct tax enforcement. They used HVY to strip billions out of Yukos, and the Russian Oligarchs are still enjoying the fruits of their crimes. HVY are owned and controlled by the Russian Oligarchs. HVY adopted false statements about the corporate structure and withheld the relevant documents.

A. Introduction

504. As stated above, this Court of Appeal may also, either immediately or in addition or instead, hear and rule on the respondent's other grounds of action still remaining as a result of the devolutive effect of the appeal proceedings. In the unlikely event that this Court of Appeal first addresses HVY's grounds for appeal and finds that the District Court wrongly set aside the Yukos Awards on the basis of its interpretation of Article 45 ECT and the consequence lack of jurisdiction of the Tribunal, the below grounds for setting aside will be discussed again on the basis of the devolutive effect of the appeal proceedings. In the Arbitrations and in the proceedings at first instance the Russian Federation has detailed the facts underlying the present dispute.⁷⁵¹ This dispute between the Russian Federation and Russian Oligarchs concerns a wide range of illegal activities by these Russian Oligarchs. These illegalities are crucial to a number of the annulment grounds in the present appellate proceedings.
505. According to HVY, “[t]he present case of course began with the Arbitrations. The Arbitrations concern exclusively the actions of the Russian Federation in the period July 2003 – November 2007.”⁷⁵² These two sentences encapsulate the core of HVY's strategy with respect to the facts of this case, which is to focus upon only the narrowest possible period of time and exclude all surrounding context.⁷⁵³ In other words, HVY's hope is that this Court will disregard all facts and events occurring both before 2003 and after 2007. They hope the Court of Appeal will simply ignore the illegal conduct of the Russian Oligarchs and HVY.
506. HVY's strategy is disconnected from the law, the evidence, and common sense. The Arbitrations were not in any way confined to the period between July 2003 and November

⁷⁵¹ Writ, §§ 30-60, SoR, §§ 26-33.

⁷⁵² SoA, § 14.

⁷⁵³ HVY have e.g. tried exclude relevant witness statements from the record. Thereto, they adduced and continue to adduce a number of procedural arguments. In fact – as indicated before – HVY try to avoid that the Court of Appeal would take notice of these witness statements. See chapter III.C above.

2007. Neither are these proceedings. In fact, the annulment grounds raised in these proceedings concern factual events before 2003 and after 2007. Who are HVY, why were HVY originally created, who continuously controlled HVY from their creation until today, and how did HVY become the majority shareholders of the multibillion-dollar State-owned entity known as Yukos Oil Company? The answers to these and other questions of fact are important for the decision in these proceedings.
507. This Chapter will set out that HVY are offshore shell companies established in tax havens. They were owned and controlled at all relevant times by Russian Oligarchs. They are the former owners and directors of a liquidated Russian bank known as Bank Menatep.⁷⁵⁴ HVY were created for the illegal purposes of tax evasion,⁷⁵⁵ the disguised payment of bribes,⁷⁵⁶ and the concealment of illegally-obtained Yukos shares.⁷⁵⁷
508. HVY are not genuine benevolent and real – existing – foreign investors who sought to contribute much-needed foreign investment to the Russian economy. To the contrary, HVY are three members of a vast network of more than 500 shell companies⁷⁵⁸ by which the Russian Oligarchs have committed crimes and further impoverished the Russian people for their own personal gain.
509. As reflected in the Final Awards, the Russian Oligarchs' illegal activities can be characterized as twenty-eight individual instances of unlawful conduct.⁷⁵⁹ In most of those

⁷⁵⁴ See List of Members of the Board of Directors of Bank Menatep dated 1 Nov. 1996 (Expert opinion Prof. Pieth dated 27 January 2017 ("**Expert Opinion Prof. Pieth**") (**Exhibit RF-D13**) Annex MP-033). This list identifies Mr. Brudno, Mr. Dubov, Mr. Golubovich, Mr. Khodorkovsky, Mr. Lebedev, and Mr. Nevzlin as the directors and executives of Bank Menatep. Also see *Hulley v. Russian Federation*, HEL Interim Award, Appendix (identifying Mr. Brudno, Mr. Dubov, Mr. Golubovich, Mr. Khodorkovsky, Mr. Lebedev, Mr. Nevzlin, and Mr. Shakhnovsky as HVY's beneficial owners).

⁷⁵⁵ See Expert opinion Prof. Rosenbloom dated 1 April 2011 ("**Expert Opinion Prof. Rosenboom 2011**") §§ 90 et seq. and expert opinion Prof. Rosenbloom dated 15 August 2012 ("**Expert Opinion Prof. Rosenboom 2012**") § 121; see also Final Awards, marginal 1620.

⁷⁵⁶ See Expert Opinion Prof. Pieth January 2017 (**Exhibit RF-D13**), §§ 148-150; Expert Opinion of Prof. Pieth dated 10 October 2017 ("**Expert Opinion Prof. Pieth October 2017**") (**Exhibit RF-D14**), §§ 117-121.

⁷⁵⁷ See Expert Opinion of Prof. Kothari dated 20 October 2015 ("**Expert Opinion Prof. Kothari 2015**") (**Exhibit RF-202**), §§ 22-24; Expert Opinion of Prof. Kothari dated 26 November 2017 ("**Expert Opinion Prof. Kothari 2017**") (**Exhibit RF-D15**), §§ 4, 83-84.

⁷⁵⁸ Anilionis Declaration (**Exhibit RF-200**) §§ 6 et seq.; see also Zakharov Declaration (**Exhibit RF-201**), §§ 2 et seq.; Gololobov Declaration (**Exhibit RF-G2**), §§ 23-29.

⁷⁵⁹ Final Awards Category 1/Phase 1: "*Conduct Related to the Acquisition of Yukos and the Subsequent Consolidation of Control over Yukos and its Subsidiaries*" (Final Awards, marginal nos. 1283-1290),

twenty-eight instances, the sham companies that figure as appellants in these proceedings played a pivotal role.

510. The twenty-eight individual illegalities can best be distinguished in broadly four phases or categories:

- (a) Phase 1 – The Russian Oligarchs used fraud, bribery, collusion and conspiracy to acquire majority control of Yukos, beginning in 1995 and 1996, while using YUL in 1996-2003 to pay at least USD 613.5 million in bribes to the public officials responsible for the Yukos privatization.⁷⁶⁰
- (b) Phase 2 – The Russian Oligarchs concealed their control over Yukos shares by transferring those to Cypriot entities. Hulley and VPL abused the 1998 Cyprus-Russia Double Taxation Agreement (the “**Russia-Cyprus DTA**”) for the fraudulent evasion of dividend taxes in the Russian Federation.⁷⁶¹

Category 2/Phase 2: “*Conduct Related to the Cyprus-Russian DTA*” (Final Awards marginal nos. 1291-1306 and 1616-1621), Category 3/Phase 3: “*Conduct Related to the Tax Optimization Scheme*” (Final Awards, marginal nos. 1307-1308 and 272-502), Category 4/Phase 4: “*Actions Taken in Hindrance of the Enforcement of Russia’s Tax Claims*” (Final Awards, marginal nos. 1309-1310). See also Resp. Rej. on the Merits (**Exhibit RF-03.1.B-5**) § 1435; SoD § 805.

⁷⁶⁰ Final Awards, marginal no. 1283 (listing the following purposeful illegal activities): “(i) Violating the legal requirements governing the loans-for-shares program that allowed Menatep to gain its controlling interest in Yukos; (ii) Using shell company proxies to feign competition in the loans-for-shares auction and a simultaneous investment tender for Yukos shares; (iii) Precluding actual competitors from bidding on Yukos shares in the loans-for-shares auction and investment tender, including through the abuse of Menatep’s role as auction organizer to disqualify Russian competitors; (iv) Rigging a subsequent auction for the Yukos shares that were being held as collateral following the initial loans-for-shares auction, which deprived the Russian Government of substantial revenue; (v) Conspiring with Yukos’ pre-existing managers to facilitate the unlawful acquisition of Yukos by the Oligarchs, including by entering into an agreement whereby “Yukos Universal” committed to pay them compensation consisting of 15% of Menatep’s beneficial interest in Yukos, ultimately worth billions of dollars, for “services rendered to ‘Yukos’”; (vi) Colluding with others to predetermine the post-privatization ownership of Yukos; (vii) Skimming profits from Yukos and its production subsidiaries for their own self-enrichment; (viii) Abusing Russian corporate law and principles of corporate governance by squeezing out minority shareholders in Yukos’ production subsidiaries through ruthless and self-enriching share dilutions, asset stripping, and transfer pricing; (ix) Siphoning off huge sums for the benefit of the Oligarchs from Yukos’ proceeds from the sale of oil and oil products, while concealing related-party transactions from Yukos’ own auditor; (x) Further mistreatment of minority shareholders by manipulating shareholder meetings, pressuring the Russian Federal Securities Commission not to pursue its challenges against illegal misconduct, relying on fraudulently determined stock and asset values and deceiving those minority shareholders, the government, and domestic and foreign courts about the nature and control of offshore companies that were created to benefit Claimants and their cohorts; (xi) Manipulating Yukos’ stock value to devalue and reacquire the interests of creditors to which Yukos stock had been pledged.” See also Resp. Rej. on the Merits § 1435.

⁷⁶¹ Final Awards, marginal no. 1291 (listing the following illegal and bad-faith activities): “(xii) Submitting fraudulent claims under, or otherwise abusing, the Russia-Cyprus Tax Treaty to evade hundreds of

- (c) Phase 3 – The Russian Oligarchs unlawfully abused Russian shell companies to commit further multibillion-dollar tax frauds. They abused rules in the Russian Federation’s low-tax regions with respect to income from the sale of the oil produced by Yukos.⁷⁶²
- (d) Phase 4 – After their tax frauds were discovered, the Russian Oligarchs methodically took measures to obstruct tax enforcement and conceal the evidence of their illegal activities. Simultaneously, they used HVY to strip more than USD 6 billion out of Yukos in dividends, share buybacks, and assets.⁷⁶³

*millions of dollars in Russian taxes payable on dividends involving Yukos shares, thereby also violating Russian and Cypriot criminal laws; (xiii) Entering into hundreds of sham transactions involving the sale and repurchase of Yukos shares between Claimants and their affiliates, the sole purpose of which was to fraudulently suggest that Claimants beneficially owned dividends declared on Yukos shares, and thereby to further Claimants’ fraudulent claims for favorable tax treatment under the Russia-Cyprus Tax Treaty; (xiv) Evading hundreds of millions of dollars in Russian taxes on profits from transactions in and profits from sales of Yukos shares. . . . ; (xvi) Diverting the proceeds of the Yukos tax evasion scheme into highly opaque Cypriot and British Virgin Islands entities and trusts to conceal the unlawful provenance of those proceeds, including through dividend distributions to undisclosed Cypriot parent companies of trading shells, thereby further abusing the Russia-Cyprus Tax Treaty.” See also Resp. Rej. on the Merits (**Exhibit RF-03.1.B-5**) § 1435.*

⁷⁶² Final Awards, marginal no. 1307 (listing the following illegal and bad-faith activities): “(xv) Engineering through management installed and controlled by Claimants the massive Yukos tax evasion scheme to avoid paying hundreds of billions of rubles in Russian taxes . . . ; (xvii) Engaging in abusive corporate restructurings to conceal Yukos’ affiliation with its trading shells, thereby preventing Russian authorities from identifying and addressing Yukos’ tax abuses; (xviii) Concealing Yukos’ continued control of its trading shells by resorting to call options or other artifices and by fabricating corporate and other transactional documents”. See also Resp. Rej. on the Merits § 1435.

⁷⁶³ Final Awards, marginal no. 1309 (listing the following illegal and bad-faith activities): “(xix) Repeatedly obstructing the conduct of the tax authorities’ audits of Yukos by refusing to provide documents and information which would show the extent of Yukos’ abuses, and by causing Yukos’ producing subsidiaries and other related entities to be similarly obstructive; (xx) Failing to pay Yukos’ tax liabilities for tax year 2000 and following years, despite having received ample notice that Yukos would be required to pay these amounts and despite the fact that Yukos had abundant resources to do so; (xxi) Dissipating assets to frustrate the Russian authorities’ collection of the tax assessments, including by way of paying dividends of unprecedented amounts, making spontaneously accelerated loan “prepayments” to Oligarch-owned Moravel, and foisting upon YNG an upstream guarantee up to USD 3 billion for the repayment of Yukos’ alleged “debts” to Moravel; (xxii) Offering to the Russian authorities assets which Yukos knew to be tainted to settle its tax liabilities; (xxiii) Concealing the share registers of Yukos’ subsidiaries to obstruct the bailiffs’ enforcement of Yukos’ tax obligations; (xxiv) Sabotaging the YNG auction through litigation threats and a spurious bankruptcy filing in the United States that effectively prevented all but one bidder from placing a bid at the auction and artificially depressed the amount of the auction proceeds; (xxv) Implementing asset-stripping measures by diverting Yukos’ valuable assets to the stichtings managed by former Yukos officers and representatives of Claimants in anticipation of Yukos’ bankruptcy; (xxvi) Failing to repay Yukos’ debt to the SocGen syndicate and frustrating the banks’ attempts to collect against Yukos’ Dutch assets; (xxvii) In the process of all of the foregoing, lying to Yukos’ auditors PwC about core aspects of their misconduct and, through PwC’s certification of Yukos’ financial statements based on this deception of Yukos’ auditors, to Yukos’ creditors and other members of the investing public who relied upon those financial statements and PwC’s certification of them; (xxviii) Yukos management’s

511. The Tribunal– wrongly – refused to consider and decide upon the illegalities in Phases 3 and 4 because they would “*relate to actions that were taken after the making of Claimants’ investment [which] cannot have any impact of the availability of ECT protection for Claimants.*”⁷⁶⁴ The Tribunal – equally wrongly – refused to consider and decide upon illegalities in Phase 1, arguing that “*the alleged illegalities connected to the acquisition of Yukos through the loans-for-shares program occurred in 1995 and 1996, at the time of Yukos’ privatization. They involved Bank Menatep and the Oligarchs, an entity and persons separate from Claimants, one of which – Veteran - had not even come into existence.*”⁷⁶⁵ The Tribunal's ruling is inconsistent; elsewhere in the Final Awards, when referring to the “*expectations of Claimants*”, the Tribunal considered the expectations of the Russian Oligarchs themselves.⁷⁶⁶ Moreover, the Tribunal ignored uncontested evidence of the direct involvement of HVY in most of the illegalities.
512. As detailed further in Part III.B, *both* the Russian Oligarchs *and* HVY were actively involved in most – if not all – of the twenty-eight illegalities. Most of the relevant facts are not actually disputed. With respect to those few facts which are disputed, reference is made to the findings of the English High Court (Phase 1),⁷⁶⁷ the Tribunal itself (Phase 2),⁷⁶⁸ and the European Court of Human Rights (“ECtHR”) (Phase 3).⁷⁶⁹ These decisions confirm the correctness of the Russian Federation's statements.

shielding of Yukos’ very substantial foreign assets behind the veil of two Dutch stichtings, to place those assets beyond the reach of Russian tax authorities, violated Dutch law”. See also Resp. Rej. on the Merits § 1435.

⁷⁶⁴ Final Awards, marginal no. 1365. [English original text]: “*relate to actions that were taken after the making of Claimants’ investment [which] cannot have any impact of the availability of ECT protection for Claimants.*” The Tribunal considered and decided upon group (b), the tax evasion under the Cyprus-Russian Doubt Taxation Treaty, in the context of contributory negligence (Final Awards, marginal nos. 1616-1621). Also see SoR, § 29.

⁷⁶⁵ Final Awards, marginal no. 1370. [English original text]: “*the alleged illegalities connected to the acquisition of Yukos through the loans-for-shares program occurred in 1995 and 1996, at the time of Yukos’ privatization. They involved Bank Menatep and the Oligarchs, an entity and persons separate from Claimants, one of which – Veteran - had not even come into existence.*”

⁷⁶⁶ Final Awards, marginal no. 1578. See also for more detail SoR, § 269.

⁷⁶⁷ See Part III.B(a) and *Berezovsky v. Abramovich* (RME-4654).

⁷⁶⁸ See Part III.B(b) and Final Awards, marginal no. 1620.

⁷⁶⁹ See Part III.B(c), ECtHR 20 September 2011 (*Yukos v. Russia*), App. No. 14902/04, (RME-3328), § 591 and ECtHR 25 July 2013 (*Khodorkovskiy and Lebedev v. Russia*), Apps. Nos. 11082/06, 13772/05, § 786 (**Exhibit RF-4**).

513. The Russian Federation's contentions are also supported by extensive documentary evidence, which has been meticulously analyzed by renowned experts. The documentary evidence relates to issues pertaining to bribery, fraud, and money-laundering (Professor Pieth and Professor Kraakman), forensic accounting (Professor Kothari), and abuse of the Russia-Cyprus DTA (Professor Rosenbloom and Professor van Weeghel).⁷⁷⁰ Finally, the Russian Federation's contentions regarding the Russian Oligarchs' illegal activities have been confirmed consistently in public statements *by the Russian Oligarchs themselves*,⁷⁷¹ as well as by their business associates and employees.⁷⁷²
514. As detailed below in Part III.C, HVY are neither "separate from" the Russian Oligarchs nor "controlled by" the trustees in Guernsey and Jersey.⁷⁷³ The Russian Oligarchs in reality have personally intervened continuously in HVY's affairs and exercised decision-making power as to HVY's most important financial transactions until as recently as 2015.

B. The unlawful conduct of the Russian Oligarchs and HVY

515. In the forthcoming sections of Part III.B, the Russian Federation addresses the twenty-eight illegalities of the Russian Oligarchs, in each of the four phases. These wrongdoings have been outlined in great detail in the Arbitrations. New evidence that was obtained after the Russian Federation filed its Statement of Reply confirms the illegal conduct of both the Russian Oligarchs and HVY. It concerns the witness statements of Mr. Anilionis, Mr.

⁷⁷⁰ Expert Opinion Prof. Pieth January 2017 (**Exhibit RF-D13**) §§ 148-149, Expert Opinion Prof. Pieth October 2017 (**Exhibit RF-D14**), §§ 117-121, Expert Opinion of Prof. Kraakman dated 1 April 2011 ("**Expert Opinion Prof. Kraakman**") (**Exhibit RF-03.1.C-2.2.5**), §§ 28-42, Expert Opinion Prof. Kothari 2015 (**Exhibit RF-202**), § 45, Expert Opinion Prof. Kothari 2017 (**Exhibit RF-D15**), §§ 53-67, Expert Opinion Rosenbloom 2011, §§109 et seq., Expert Opinion Prof. Rosenbloom 2012, § 165 and Expert Opinion of Prof. Van Weeghel 2007 dated 29 January 2017 (submitted by the Russian Federation in the Arbitrations at Respondent's Second Memorial on Jurisdiction, p. 33).

⁷⁷¹ Mikhail Khodorkovsky's Facebook Post dated 9 June 2016 (Expert Opinion Prof. Pieth October 2017 (**Exhibit RF-D14**), Annex MP-139). *See also* Transcript of Nevzlin's Testimony (**Exhibit RF-03.1.G-4.2**), p. 28-37, Expert Opinion Prof. Pieth 2017 (**Exhibit RF-D14**), Dubov Declaration (**Exhibit RF-03.1.G-4.1**), §§ 20-30, transcript of Golubovich's first 2015 Interview (**Exhibit RF-299**), p. 6-9 and the transcript of Golubovich's Second 2015 Interview (**Exhibit RF-300**), p. 5-8.

⁷⁷² Mr David Godfrey Declaration dated 7 June 2016 (**Exhibit RF-295**), Mr Anilionis Declaration (**Exhibit RF-200**), §§ 23-33; Mr Zakharov Declaration (**Exhibit RF-201**), § 5, Mr Dimitri Gololobov Declaration dated 26 July ("**Gololobov Declaration**") (**Exhibit RF-G2**), § 5; Berezovsky Declaration (**Exhibit RF-255**), § 121, transcript of Muravlenko's Testimony, 14 May 2007 (**Exhibit RF-301**), p. 5, transcript of Douglas Miller's First Interview (RME-0017), p. 3-7, transcript of Douglas Miller's Third Interview (RME-871), p. 4-12 and Feldman Amended Answer and Complaint 28 September 2016 (**Exhibit RF-302**), pp. 23-34.

⁷⁷³ *See* SoA, §§ 806, 807 and 840-841.

Zakharov, Mr. Gololobov and Mr. Rybin, as well as expert evidence by Prof. Kothari and Prof. Pieth.

(a) ***Phase 1 - The Russian Oligarchs Obtained HVY's Yukos Shares by Fraud, Bribery and Collusion: Bribes Were Paid by YUL***

(a)(i) *Introduction*

516. Phase 1 involved the use of fraud, bribery and collusion to acquire Yukos shares.⁷⁷⁴ YUL was used to pay at least USD 613.5 million in bribes to public officials responsible for supervising the Yukos privatization.⁷⁷⁵
517. The Russian Oligarchs obtained Yukos in the middle of the 1990s. It was economically and socially the most vulnerable period in the modern history of the Russian Federation. The Soviet Union's dissolution brought a decade of serious economic hardship. The Russian Federation's GDP dropped by 60%,⁷⁷⁶ and inflation reaching a shocking 875%.⁷⁷⁷ *"In 1989, only 2 percent of those living in Russia were in poverty. By late 1998, that number had soared to 23.8 percent . . . with more than 50 percent [of children] living in families in poverty."*⁷⁷⁸
518. In the midst of the Russian people's economic and social crisis, however, the Russian Oligarchs suddenly became multibillionaires overnight through the Yukos privatization. In 1994, six of them – Mr. Brudno, Mr. Dubov, Mr. Golubovich, Mr. Khodorkovsky, Mr. Lebedev, and Mr. Nevzlin – were the executives and directors of Bank Menatep.⁷⁷⁹ Bank Menatep was a moderately-sized organization which had been "linked to Russian

⁷⁷⁴ This is set out in great detail in Resp. C-Mem (**Exhibit RF-03.1.B-3**), §§ 18-43.

⁷⁷⁵ Final Awards, marginal no. 1283. *See also* Resp. Rej. on the Merits (**Exhibit RF-03.1.B-3**), § 1435.

⁷⁷⁶ World Bank, GDP (in \$ of such year) Russian Federation (1989-2000) available at <http://data.worldbank.org/indicator/NY.GDP.MKTP.CD?end=2000&locations=RU&start=1989>.

⁷⁷⁷ World Bank, Inflation consumer prices (annual %) Russian Federation (1993-2000) available at <http://data.worldbank.org/indicator/FP.CPI.TOTL.ZG?end=2000&locations=RU&start=1989>.

⁷⁷⁸ Joseph E. Stiglitz, *Globalization and Its Discontents*, WW Norton & Co: New York, 2002 (**Exhibit RF-303**), p. 153.

⁷⁷⁹ List of Members of the Board of Directors of Bank Menatep dated 1 Nov. 1996 (Expert Opinion Prof. Pieth January 2017 (**Exhibit RF-D13**), MP-033). At a later point in time, Mr. Shakhnovsky joined the select group of Russian Oligarchs. *See* the names of the Oligarchs on the Appendix added to the HEL Interim Awards, on which Mr. Shakhnovsky is also mentioned as one of the Russian Yukos.

organized crime”, said a U.S. intelligence report shared with the *Washington Times*.⁷⁸⁰ By the end of 1995, the Yukos privatization had transformed these six Russian Oligarchs into some of the wealthiest people in the world.

519. The State-owned Yukos enterprise was created in April 1993. Subsequently, it was privatized in a series of procedures that supposedly provided for competitive bids.⁷⁸¹ These procedures included a simultaneous investment tender and “Loans-for-Shares” auction in December 1995, and a subsequent auction in December 1996.⁷⁸² The Russian Oligarchs’ associate played an important role. It concerned Konstantin Kagalovsky, an executive of Bank Menatep. He was appointed by the State Property Committee to supervise part of this privatization process as a neutral auction administrator.⁷⁸³
520. Yukos was enormously valuable, with annual revenues of approximately USD 5 billion and proven oil reserves of approximately 10 billion barrels of oil.⁷⁸⁴ This is comparable to the proven reserves in States such as Norway or Algeria.⁷⁸⁵ Yukos thus ranked as the thirteenth-largest oil company in the world, approximately the size of Total S.A.⁷⁸⁶ However, the State only received approximately USD 170 million for 78% of Yukos.⁷⁸⁷ Observers consistently deemed this to be an “absurdly low” price for a multibillion-dollar

⁷⁸⁰ Washington Times, 'Most of Russia's Biggest Banks Linked To Mob, CIA Report Says,' 5 Dec. 1994 (**Exhibit RF-304**).

⁷⁸¹ Gololobov Declaration (**Exhibit RF-G2**), §§ 6-22; Expert Opinion Prof. Pieth January 2017 (**Exhibit RF-D13**), §§ 11-60, Expert Opinion Prof. Pieth October 2017 (**Exhibit RF-D14**), §§ 65-75, Prof. Kraakman Report (**Exhibit RF-03.1.C-2.2.5**), § 14-27.

⁷⁸² Gololobov Declaration (**Exhibit RF-G2**), §§ 8-10, 13-14, Anilionis Declaration (**Exhibit RF-200**), §§ 16-21, Prof. Kraakman Report (**Exhibit RF-03.1.C-2.2.5**), §§ 8-13 and Decree of the President of the Russian Federation No. 889 (Aug. 31, 1995) (RME-7).

⁷⁸³ Gololobov Declaration (**Exhibit RF-G2**), § 14, Prof. Kraakman Report (**Exhibit RF-03.1.C-2.2.5**), § 17 and the Decree of the President of the Russian Federation No. 889 (Aug. 31, 1995) (Exhibit RME-7).

⁷⁸⁴ Expert Opinion Prof. Pieth October 2017 (**Exhibit RF-D14**), §§ 10-12, Report on Yukos Oil Corporation “Yukos and Sibneft to Combine Operations Create World's Largest Oil Company Based on Reserves” dated 19 Jan. 1998 (Expert Opinion Prof. Pieth October 2017 (**Exhibit RF-D14**) MP-156), at 3.

⁷⁸⁵ Expert Opinion Prof. Pieth October 2017 (**Exhibit RF-D14**), § 11, OPEC Chart of Oil Reserves dated 1998 (Expert Opinion Prof. Pieth October 2017 (**Exhibit RF-D14**) MP-155).

⁷⁸⁶ Expert Opinion Prof. Pieth October 2017 (**Exhibit RF-D14**), § 10, Lazare Francoise, *Concerns about the continuation of the privatization program*, LA MONDE dated 20 Dec. 1995 (Expert Opinion Prof. Pieth October 2017 (**Exhibit RF-D14**) MP-150).

⁷⁸⁷ Expert Opinion Prof. Pieth January 2017 (**Exhibit RF-D13**), § 47. Separately, ZAO Laguna also undertook to make investment commitments of approximately USD 350 million, which would not actually be paid to the Russian Federation but which would be invested into YUKOS itself. See Expert Opinion Prof. Pieth October 2017 (**Exhibit RF-D14**) (Annex MP-141), §§ 33,47.

oil company,⁷⁸⁸ also because the ostensible purpose of the “Loans-for-Shares” program was to raise additional finances to help support the Government’s budget.⁷⁸⁹

521. Throughout the Arbitrations the Russian Federation, on the basis of expert reports and documentary evidence, has consistently stated that the Yukos privatization was illegally manipulated.⁷⁹⁰ This has never been genuinely disputed. HVY’s expert, Prof. Paul B. Stephan confirmed the transactions that led to the privatization of Yukos were “*indeed notorious*” and that a “*clear conflict of interest*” ensured that “*the possibility that Russia would receive anything like a fair return seemed vanishingly remote*”. Prof. Stephan further conceded that “*abuses of corporate governance undoubtedly occurred*”.⁷⁹¹ As will be set out below, the main techniques used to manipulate the auctions were bid rotation, shadow bidding and bribery.

(a)(ii) *Bid rotation*

522. The Russian Oligarchs successfully used many illegitimate strategies to obtain the shares in Yukos.⁷⁹² The Russian Oligarchs – for example – arranged with allied oligarchs, including Mr. Boris Berezovsky, to ensure that no other genuine bidders participated in the Yukos privatization.⁷⁹³ In exchange, the Russian Yukos Oligarchs agreed not to submit competing

⁷⁸⁸ Unknown Monblan Wins Third of Russia's YUKOS, Reuters, dated 23 Dec. 1996 (Expert Opinion Prof. Pieth October 2017 (**Exhibit RF-D14**), Annex MP-153).

⁷⁸⁹ Decree of the President of the Russian Federation No. 889 of Aug. 31, 1995 (RME-7).

⁷⁹⁰ See HEL First Memorial on Jurisdiction, §§ 148-153, Resp. C-Mem. on the Merits (**Exhibit RF-03.1.B-3**), §§ 44 et seq. and Resp. Rej. on the Merits (**Exhibit RF-03.1.B-5**), §§ 1435 et seq. See also the summary in Final Awards marginal 1283.

⁷⁹¹ See Stephan, Paul B., 'Taxation and Expropriation - The Destruction of the Yukos Oil Empire', Houston Journal of International Law, Forthcoming; Virginia Public Law and Legal Theory Research Paper No. 2012-48, p. 4 and 9, available at SSRN: <https://ssrn.com/abstract=2138241>. Original English text: “*indeed notorious*”, “*clear conflict of interest*”, “*the possibility that Russia would receive anything like a fair return seemed vanishingly remote*” and “*abuses of corporate governance undoubtedly occurred*”.

⁷⁹² See Resp. C-Mem. on the Merits (**Exhibit RF-03.1.B-3**) §§ 23-26.

⁷⁹³ As Mr. Berezovsky explained in English proceedings, “*I reached agreement with (among others) Mr Khodorkovsky and his Menatep colleagues . . . that we would not compete against each other in any of the loans-for-shares auctions.*”. Berezovsky Declaration (**Exhibit RF-255**), Annex R-265 § 121. See also Moscow Times, “Auctions End on Contentious Note,” Dec. 29, 1995 (**Exhibit RF-225**, Annex R-264).

bids during the privatization of other massive State-owned enterprises (such as Sibneft).⁷⁹⁴
Such illegal arrangements are referred to as “bid rotation” schemes.⁷⁹⁵

523. This bid-rotation scheme was described in detail in the English High Court’s judgment in *Berezovsky v. Abramovich*, based on testimony from the bid-rotation scheme’s participants.⁷⁹⁶ For example, Khodorkovsky helped Berezovsky to rig an auction by placing a pre-fixed (lower) bid at an auction. The High Court ruled:

"The only other bidder at the auction itself was a syndicate organised by Bank Menatep, controlled by Mr. Khodorkovsky. He had agreed with Mr. Berezovsky, in advance, to bid slightly more than the reserve and slightly less than NFK. According to Mr. Berezovsky, this resulted from earlier agreements with Mr. Khodorkovsky and his Menatep colleagues, and with other oligarchs who were interested in obtaining control of other State businesses under the loan-for-shares scheme, that they would not compete against each other in any of the loans-for-shares auctions."⁷⁹⁷

524. Indeed one of the Russian Oligarchs, Mr. Nevzlin, has confirmed this aspect of the collusive scheme:

"We reached an agreement on who would take what. We agreed not to get in each others' way."⁷⁹⁸

525. As explained by Professor Asoskov, this conspiracy violates Russian law, including the rules of President Yeltsin’s Decree No. 889, the Civil Code, and Russian statutes on

⁷⁹⁴ *Berezovsky v. Abramovich* §§ 224 (RME-4654); see Moscow Times, “Auctions End on Contentious Note,” Dec. 29, 1995 (**Exhibit RF-225**, Annex R-264).

⁷⁹⁵ Fraud and Corruption Awareness Handbook, p. 36 (Expert Opinion Prof. Pieth January 2017 (**Exhibit RF-D13**, Annex MP 106); The Many Faces of Corruption Tracking Vulnerabilities at the Sector Level, p. 302 (Expert Opinion Prof. Pieth January 2017 (**Exhibit RF-D13**), Annex MP-88).

⁷⁹⁶ On 31 August 2012 the High Court ruled in the case of *Berezovsky v. Abramovich* on the Sibneft auction (RME-4654) § 224. Also see Berezovsky Witness Testimony (**Exhibit RF-225**, Annex R-266), Transcript of Boris Berezovsky’s Oral Testimony Day 4, at p. 52 (“*Q. Menatep was a bank associated with Mr Khodorkovsky and Yukos, wasn’t it? A. It is correct. Q. Did you agree with Mr Khodorkovsky in advance that his bid would be made at a slightly lower level than NFK’s? A. It is correct.*”

⁷⁹⁷ High Court 31 August 2012, *Berezovsky v. Abramovich* on the Sibneft auction (RME-4654).

⁷⁹⁸ Resp. C-Mem. on the Merits (**Exhibit RF-03.1.B-3**) § 22. Freeland, p. 166 (RME-5). Mr. Nevzlin was also heard as a witness in the case of *Berezovsky v. Abramovich*. He testified: “[A]ll the companies which participated in these loans for share auctions, all, further down the line, became the owners of these privatised [companies]. And the question of ownership structure was discussed and decided by them before they entered the auction, before they made their investment.” (**Exhibit RF-225**, Annex R-269, at p. 65-66).

privatization and competition.⁷⁹⁹ Based on these rules of law, the privatization of Yukos was thus rendered legally void ab initio.⁸⁰⁰

(a)(iii) *Shadow Bidding*

526. The only bidders that were ultimately permitted to participate in the Yukos privatization were sham companies controlled by the Russian Oligarchs.⁸⁰¹ Specifically, the formal directors of these sham companies were all employees of a company called "RTT". RTT acted at the Russian Oligarchs' instructions.⁸⁰² Mr. Mikhail Khordokovsky, one of the Russian Oligarchs, was the Chairman of the Board of RTT.⁸⁰³
527. The director of RTT, Mr. Anilionis, explained that the Russian Oligarch Lebedev had instructed him personally to create sham companies that would pretend to "compete" in rigged auctions. In his witness testimony, Mr. Anilionis describes how he ordered the creation of ZAO Laguna and ZAO Reagent, two shell companies that placed two prefixed bids at the 1995 auction. Both bids only slightly exceeded the minimum price:

"19. In a private discussion with Mr. Lebedev, he advised me that Mr. Khodorkovsky wanted to obtain OAO Yukos Oil Company by manipulating a loans-for-shares auction. I went to two or three meetings with executives from Bank Menatep and ZAO Rosprom, where the strategy was explained by Mr. Kagalovsky. My task was clear: I had to create two companies which would "compete" to make the loan, and ultimately obtain rights to the shares.

20. Accordingly, on December 8, 1995, two companies called ZAO Laguna and ZAO Reagent, both of which had been created and registered by RTT, participated in a loans-for-shares auction and a simultaneous investment tender for the shares of OAO Yukos Oil Company. The nominal director of ZAO Laguna was my employee, Mr. Zakharov. The nominal director of ZAO Reagent was my employee, Mr. Koval. (...) ZAO Laguna and ZAO Reagent were the only two participants that were ultimately allowed to participate in this particular loans-for-shares auction and investment tender. ZAO Reagent submitted a bid of USD 150.1 million, which was slightly more than the

⁷⁹⁹ Expert Report Prof. Asoskov 2015 (**Exhibit RF-203**) §§ 35-48.

⁸⁰⁰ Expert Report Prof. Asoskov 2015 (**Exhibit RF-203**) §§ 41-42.

⁸⁰¹ Resp. C-Mem. on the Merits (**Exhibit RF-03.1.B-3**) §§ 27-30, Memorial on Jurisdiction; Chart 8 in Resp. C-Mem § 275.

⁸⁰² Anilionis Declaration (**Exhibit RF-200**) § 12; Zakharov Declaration (**Exhibit RF-201**) § 17; Gololobov Declaration (**Exhibit RF-G2**) § 25.

⁸⁰³ Anilionis Declaration (**Exhibit RF-200**) § 12; Zakharov Declaration (**Exhibit RF-201**) § 17; Gololobov Declaration (**Exhibit RF-G2**) § 25.

minimum price (of US\$ 150 million) and slightly less than ZAO Laguna's bid of USD 159 million. This caused ZAO Laguna to be selected as the winner of both the auction and the tender. (...).⁸⁰⁴

528. Others involved in the 1995 and 1996 auctions confirm the use of sham companies. Mr. Zakharov, fictitious director of sham company ZAO Laguna during the 1995 auction, confirms that the auctions were in fact controlled and prepared by Bank Menatep. He also explains how the 1996 auction was rigged in more or less the same way:

"10. The only two entities that participated in this tender were ZAO Monblan and OAO Moscow Food Factory. (...) The nominal director of ZAO Monblan was my superior at SP RTT, Mr. Kraynov. (...) At least the majority shareholding of OAO Moscow Food Factory was at that time de facto owned and controlled by Bank Menatep. Both of the auction participants were therefore companies controlled by principals of Bank Menatep. It was arranged that ZAO Monblan would submit a bid of USD 160.1 million, and OAO Moscow Food Factory would submit a bid of USD 160.05 million, allowing ZAO Monblan to win the auction. (...).⁸⁰⁵

529. These arrangements violated Russian law: Decree No. 889, the Civil Code, and several other Russian statutes require genuine competitive bidding.⁸⁰⁶ Under the explicit terms of these statutes and decrees, the Yukos privatization was therefore legally void.⁸⁰⁷ Moreover, the use of multiple sham companies to create the illusion of competition is a common technique ("shadow bidding"). *Shadow bidding* is clearly illegal and frequently associated with collusive bid-rigging and bribery.⁸⁰⁸

⁸⁰⁴ Anilionis Declaration (**Exhibit RF-200**) §§ 19 and 20.

⁸⁰⁵ Zakharov Declaration, (**Exhibit RF-201**), § 10.

⁸⁰⁶ Gololobov Declaration (**Exhibit RF-G2**) § 9; Expert Opinion Prof. Asoskov 2015 (**Exhibit RF-203**) § 47; *see also* Resolution of the State Duma of the Federal Assembly of the Russian Federation. No. 3331-II-GD, Dec. 4, 1998 (R-19).

⁸⁰⁷ Gololobov Declaration (**Exhibit RF-G2**) § 9; Expert Opinion Prof. Asoskov 2015 (**Exhibit RF-203**) §§ 49-52; *see also* Resolution of the State Duma of the Federal Assembly of the Russian Federation. No. 3331-II-GD, Dec. 4, 1998 (R-19).

⁸⁰⁸ Expert Opinion Prof. Pieth January 2017 (**Exhibit RF-D13**) § 32; Expert Opinion Prof. Pieth October 2017 (**Exhibit RF-D14**) §§ 49-53; WORLD BANK, FRAUD AND CORRUPTION AWARENESS HANDBOOK 35 (2013) (Expert Opinion Prof. Pieth January 2017 (**Exhibit RF-D13**), MP-106). Gololobov Declaration (**Exhibit RF-G2**) §§ 13-14; Anilionis Declaration (**Exhibit RF-200**) §§ 17 et seq.; Expert Opinion Prof. Kraakman (**Exhibit RF-03.1.C-2.2.5**), § 18.

(a)(iv) Payment of Bribes

530. Before the privatization, Yukos Oil Company was managed by four public servants, Mr. Muravlenko, Mr. Golubev, Mr. Kazakov, and Mr. Ivanenko (“Red Directors”).⁸⁰⁹ The Red Directors would play an important role in the privatization.
531. Prior to the privatization, the Russian Oligarchs made an oral agreement with the Red Directors in which the Russian Oligarchs promised to pay 15% of the value of Yukos. In exchange for these promised payments, the Red Directors helped to facilitate the unlawful acquisition of Yukos.⁸¹⁰
532. As Professor Pieth explains,⁸¹¹ the documentary record confirms that the Red Directors, as officials, played a significant role in the privatization of Yukos:

“71. As the documentary record unmistakably reflects, the Red Directors and their subordinates did play significant roles in every stage of the YUKOS privatization from March 1993 until December 1995. Most critically, (1) the Red Directors evidently designed several of the ‘privatization plans’ and the ‘investment program’ pertaining to YUKOS, which the Government then adopted;⁸¹² (2) the most senior Red Director, Mr. Sergey Muravlenko, used his official position as the President of YUKOS to advise the Government that the ‘Loans-for-Shares’ auction pertaining to 45% of YUKOS must become ‘interconnected’ with the YUKOS Investment Tender pertaining to 33% of YUKOS (a decision which significantly benefited the Oligarchs);⁸¹³ (3) the Red Directors also were charged with the task of collecting the prospective bidders’ applications for distribution to the Investment Tender Commission;⁸¹⁴ and (4) the Red Directors’ subordinates participated directly

⁸⁰⁹ Expert Opinion Prof. Pieth January 2017 (**Exhibit RF-D13**) § 5; Expert Opinion Prof. Pieth October 2017(**Exhibit RF-D14**) § 2.

⁸¹⁰ See Resp. C-Mem. on the Merits (**Exhibit RF-03.1.B-3**) §§ 36-40, Expert Opinion Prof. Pieth January 2017 (**Exhibit RF-D13**) §§ 11-79; Expert Opinion Prof. Pieth October 2017(**Exhibit RF-D14**) §§ 14-26; Transcript of Muravlenko’s Testimony, 14 May 2007 (**Exhibit RF-301**), p. 5; Gololobov Declaration (**Exhibit RF-G2**) §§ 15-22.

⁸¹¹ Expert Opinion Prof. Pieth October 2017 (**Exhibit RF-D14**) §§ 71-73.

⁸¹² Protocol No. 3 of the YUKOS Board of Directors (Expert Opinion Prof. Pieth January 2017 (**Exhibit RF-D13**, Annex MP-011), at 2; See also Investment Program, approved by Decision of the Board of YUKOS Oil Company, Minutes No. 13 dated 12 Oct. 1995 (Expert Opinion Prof. Pieth January 2017 (**Exhibit RF-D13**, Annex MP-017).

⁸¹³ Letter from S.V. Muravlenko to A.B. Chubais dated 27 Sept. 1995 (Expert Opinion Prof. Pieth January 2017 (**Exhibit RF-D13**, Annex MP-015), at 1.

⁸¹⁴ Yukos, RFPF and RF State Committee for Management of State Property Contract No. 2-14.2./473 dated 25 Jul. 1994 (Expert Opinion Prof. Pieth October 2017 (**Exhibit RF-D14**, AnnexMP-140) § 2.33; *see also* YUKOS Investment Tender Public Notice dated 4 Nov. 1995 (Expert Opinion Prof. Pieth October 2017 (**Exhibit RF-D14**, Annex MP-147), at 2. Reflecting that applications would be submitted to and

in the sessions of the YUKOS Investment Tender Commission as key advisors to the Government representatives.⁸¹⁵

72. Significantly, the address given publicly for the Investment Tender Commission, 34/21 Kutuzovsky Prospekt, Moscow,⁸¹⁶ was actually the address of the Red Directors' Moscow office.⁸¹⁷ This demonstrates that the Red Directors likely had a high degree of control over the Investment Tender Commission's activities, which ultimately led to the successful bid of the Oligarchs' proxy entity, ZAO Laguna, and the transfer of approximately 78% of YUKOS to the Oligarchs' control on 8 December 1995.

73. The documentary record thus reflects that the Red Directors were indeed capable of influencing the procedures and the results of the YUKOS privatization in the Oligarchs' favor. This provides a far more probable explanation for the Oligarchs' promise to pay 'a significant financial interest'⁸¹⁸ and subsequent payments of more than USD 614 million to the Red Directors⁸¹⁹ than either of the two conflicting ex post justifications provided in Mr. Dubov's witness statement or in the text of the 2002 sham contracts with Tempo Finance.^{820,821}

533. As one of the Red Directors, Mr. Muravlenko, later confirmed that their "help" was needed: "*In order to win, he needed the support from the team of managers of "YUKOS," i.e. our team*".⁸²² One of the other Red Directors – Mr. Ivanenko – likewise confirmed that

reviewed by the Investment Tender Committee, which would be located at the YUKOS office in Moscow, at 34/21 Kutuzovsky Prospekt.

⁸¹⁵ Meeting of Tender Commission for Investment Tender in Respect of Shares of Yukos Protocol No. 1 dated 8 Dec. 1995 (Expert Opinion Prof. Pieth October 2017 (**Exhibit RF-D14**, Annex MP-148), at 1; See also Meeting of Tender Committee on Summary of the Investment Tender Protocol No. 2 dated 8 Dec. 1995 (Expert Opinion Prof. Pieth October 2017 (**Exhibit RF-D14**, Annex MP-149), at 1.

⁸¹⁶ YUKOS Investment Tender Public Notice dated 4 Nov. 1995 (Expert Opinion Prof. Pieth October 2017 (**Exhibit RF-D14**, Annex MP-147), at 2.

⁸¹⁷ See Letter from S.V. Muravlenko to A.B. Chubais dated 27 Sept. 1995 (Expert Opinion Prof. Pieth January 2017 (**Exhibit RF-D13**, Annex MP-015), at 1. See also Agreement on Fulfilment of Investment Project between AOOT Oil Company "Yukos" and ZAO Laguna dated 12 Jan. 1996 (Expert Opinion Prof. Pieth October 2017 (**Exhibit RF-D14**, Annex MP-152) § 9.

⁸¹⁸ Memorandum from Doug Miller to Bruce Misamore dated 14 Aug. 2002 (Expert Opinion Prof. Pieth January 2017 (**Exhibit RF-D13**, Annex MP-071), at 3.

⁸¹⁹ Account Statements of Yukos Universal Limited from UBS Zurich (Expert Opinion Prof. Pieth January 2017 (**Exhibit RF-D13**, Annex MP-066).

⁸²⁰ Amended and Restated Compensation Agreement between Group Menatep Limited, Beneficiaries, and Tempo Finance Ltd. dated 1 Nov. 2002 (Expert Opinion Prof. Pieth January 2017 (**Exhibit RF-D13**, Annex MP-075).

⁸²¹ Expert Opinion Prof. Pieth October 2017 (**Exhibit RF-D14**) §§ 71-73.

⁸²² Transcript of Muravlenko's Testimony, 14 May 2007 (**Exhibit RF-301**), p. 5. Original English text: "*In order to win, he needed the support from the team of managers of "YUKOS," i.e. our team*".

UNOFFICIAL TRANSLATION

This text is an unofficial translation of the Dutch original. In case of any discrepancies, the Dutch original shall prevail.

the Russian Oligarchs “*agreed that [the Red Directors’] financial interests would be taken into account,*” in exchange for the Red Directors’ undertaking “*not [to] interfere in the management of the company*” after privatization.⁸²³

534. The Russian Oligarchs’ payments to the Red Directors were disguised by a series of sham contracts arranged between 1996 and 2003.⁸²⁴ Copies of certain important contracts made in 2002 have been filed in the Arbitrations.⁸²⁵ These ‘agreements’ were signed by the Russian Oligarch Platon Lebedev (on behalf of GML and YUL) and the Red Directors (on behalf of an offshore entity called Tempo Finance Ltd.).
535. YUL, one of the appellants in these proceedings, played a pivotal role in making the payments. The Russian Oligarchs used YUL’s bank accounts to pay at least USD 613.5 million to the Red Directors over the years 1996 until 2003. The Russian Federation hereby submits the relevant statements of account.⁸²⁶
536. The sham nature of the Russian Oligarchs’ contracts with the Red Directors is evident from numerous factors.⁸²⁷ Prof. Pieth points out (a) the Russian Oligarchs’ contradictory explanations on the alleged services rendered under these ‘agreements’, (b) the fact that key terms of the ‘agreements’ (such as the total amount of payments) were never recorded in writing, and (c) the fact that the Russian Oligarchs’ own advisors thought the ‘agreements’ lacked any basic economic rationale.⁸²⁸ Based on his analysis of the documentary record,

⁸²³ See the declaration of Ivanenko (RME-3584), p. 4. Original English text: “*agreed that [the Red Directors’] financial interests would be taken into account.*” “*not [to] interfere in the management of the company*”.

⁸²⁴ In 1996-1998 several sham agreements were drafted on the basis of which (relatively) smaller payments were made to offshore entities controlled by the Red Directors. See the Gololobov Declaration, (**Exhibit RF-WG2**), Annex R-704. Expert Opinion Prof. Pieth January 2017 (**Exhibit RF-D13**) § 139; Expert Opinion Prof. Pieth October 2017 (**Exhibit RF-D14**) § 46.

⁸²⁵ Resp. C-Mem. on the Merits (**Exhibit RF-03.1.B3**) § 36; Resp. Rej. on the Merits (**Exhibit RF-03.1.B-5**) § 1435; Original Agreement between Group Menatep Limited, Beneficiaries, and Tempo Finance Ltd. dated 26 Mar. 2002 (C-1234), Amended and Restated Compensation Agreement between Group Menatep Limited, Beneficiaries, and Tempo Finance Ltd. dated 1 Nov. 2002 (C-1240) (Expert Opinion Prof. Pieth January 2017 (**Exhibit RF-D13**, Annex MP-075).

⁸²⁶ Account Statements of Yukos Universal Limited from UBS Zurich (Expert Opinion Prof. Pieth January 2017 (**Exhibit RF-D13**, Annex MP-066).

⁸²⁷ Resp. Rej. on the Merits (**Exhibit RF-03.1.B-5**) §§ 1293 et seq., Resp. C-Mem. on the Merits (**Exhibit RF-03.1.B-3**) §§ 728 et seq.

⁸²⁸ Expert Opinion Prof. Pieth January 2017 (**Exhibit RF-D13**) § 75; Expert Opinion Prof. Pieth October 2017 (**Exhibit RF-D14**) §§ 32, 119.

Prof. Pieth concludes that these sham agreements were unquestionably used to disguise a series of bribe payments.⁸²⁹

537. In addition to the detailed factual account in the Arbitrations,⁸³⁰ the Russian Federation also submits the witness testimony of Russian Oligarchs' former legal advisor, Mr. Dmitry Gololobov. He explains how the Russian Oligarchs Khodorkovsky and Lebedev made extensive efforts to conceal the payments to the Red Directors.⁸³¹

538. Finally: the Russian Oligarch Khodorkovsky himself confided in 2003 to Yukos' accountant – Mr. Miller – that the payments made to the Red Directors were illegal and that he risked criminal prosecution. Miller:

“Khodorkovsky said (and I do not remember his exact words, but they implied) that if he confirmed that my assumptions were right and that if he told me the true reasons why the beneficiaries were receiving this money, he could be imprisoned.”⁸³²

(a)(v) *Murder, attempted murder and corporate abuse to tighten control over Yukos and its subsidiaries*

539. After the Russian Oligarchs had illegally gained control over the majority of the shares of Yukos Oil Company they kept resorting to illicit means to tighten their control over Yukos and its subsidiaries.

540. As set out in the Arbitrations, the Russian Oligarchs employed a variety of methods of corporate abuse to squeeze out minority shareholders of Yukos' subsidiaries.⁸³³ These

⁸²⁹ Expert Opinion Prof. Pieth January 2017 (**Exhibit RF-D13**) §§ 128-138; Expert Opinion Prof. Pieth October 2017 (**Exhibit RF-D14**) §§ 16-18.

⁸³⁰ Resp. Rej. on the Merits (**Exhibit RF-03.1.B-5**) §§ 1293 et seq., Resp. C-Mem. on the Merits (**Exhibit RF-03.1.B-3**) §§ 728 et seq.

⁸³¹ Gololobov Declaration (**Exhibit RF-G2**) §§ 15-22.

⁸³² Miller Interrogation Record (May 10, 2007), 8 (RME-18).

⁸³³ Expert Opinion Prof. Kraakman (**Exhibit RF-03.1.C-2.2.5**) §§ 33-40, 47, Writ, §§ 39-40, Resp. C-Mem. on the Merits (**Exhibit RF-03.1.B-3**) §§ 44 - 75. *Also see* Richard Sakwa, *The Quality of Freedom*, Oxford University Press 2009 (RME-73), p. 45-46. “[T]he third stage was transforming ownership into control. The methods used to achieve this reflected the harshest period of ‘robber baron’ capitalism in Russia. A whole range of ‘informal corporate governance practices’ were applied, including share dilution, asset stripping, transfer pricing, undermining shareholder voting rights and forced bankruptcies.” James Fenkner & Elena Krasnitskaya, *Troika Dialog, How To Steal an Oil Company*, in *Corporate Governance in Russia: Cleaning Up the Mess* (1999), p. 93 (**RME-35**).

blatant abuses of (corporate) law were widely covered in local and Western media. Mr. Gololobov – who joined Yukos in 1995 – described the reputation Yukos had at the time:

"For the first five years that I worked at Yukos, Mr. Khodorkovsky - and the companies associated with him, including Yukos, Bank Menatep, and Rosprom – developed an extremely bad reputation for abusing creditors and minority shareholders. Essentially, as the financial press often acknowledged, Yukos was ‘a synonym for rotten corporate governance.’ One article noted that ‘[i]n 1999, Yukos's reputation among western institutions had sunk from bad to awful.’”⁸³⁴

541. In addition, as set out in the Arbitrations, the Russian Oligarchs hired armed guards⁸³⁵ and assassins on multiple occasions to silence minority shareholders and vocal critics.⁸³⁶ One example concerns Vladimir Petukhov, Mayor of the city of Nefteyugansk, who had criticized Yukos' failure to pay local taxes and wages. He was shot dead on 26 June 1998, Khodorkovsky's 35th birthday.⁸³⁷ Contemporaneous newspaper accounts immediately noted the almost certain involvement of Yukos executives in this assassination,⁸³⁸ which was subsequently confirmed during court proceedings.⁸³⁹
542. The Russian Federation hereby submits a witness declaration of Mr. Yevgeny Rybin (**Exhibit RF-G3**).⁸⁴⁰ He was managing director of East Petroleum Handelgas ("EPH"). Mr. Rybin says that EPH had made substantial investments in the Tomskneft oil fields. After the Russian Oligarchs took illegitimate measures to harm EPH investments, EPH commenced arbitration proceedings in Vienna and exposed the Russian Oligarch's

⁸³⁴ Gololobov Declaration (**Exhibit RF-G2**) § 30.

⁸³⁵ See e.g. Bernard Black, Reiner Kraakman, and Anna Tarassova, Russian Privatization and Corporate Governance: What Went Wrong?, 52 Stan. L. Rev. 1731 (2000) (RME-24), p. 1771. "*The day before the subsidiaries' shareholder meetings, Yukos arranged for a compliant judge to declare that the minority shareholders were acting in concert, in violation of the Antimonopoly Law. The judge disqualified everyone but Yukos and its affiliated shareholders from voting. When minority shareholders arrived at the meetings, they were greeted by armed guards; most were barred from voting or attending on the basis of this court order.*"

⁸³⁶ Resp. C-Mem. on the Merits (**Exhibit RF-03.1.B-3**) §§ 99 - 103.

⁸³⁷ See Resp. C-Mem. on the Merits (**Exhibit RF-03.1.B-3**) §§ 99 – 103 and Writ § 49.

⁸³⁸ See Kommersant 27 June 1998, Murder of Petukhov (**Exhibit RF-305**); Moscow Times 30 May 1998, re Murder of Petukhov (**Exhibit RF-305**) - Moscow Times 30 May 1998, re Petukhov Strike Against Yukos (**Exhibit RF-305**).

⁸³⁹ See Resp. C-Mem. on the Merits (**Exhibit RF-03.1.B-3**) §§ 99 – 103, Writ § 49 and RME-166, RME-168 and RME-169.

⁸⁴⁰ Mr. Rybin's witness statement is supported by many contemporaneous documents. Some of those are attached to his witness statement (**Exhibit RF-G3**).

wrongdoings on multiple occasions. Mr. Rybin says that there were multiple attempts to murder him using machine guns in 1998 and by placing roadside bombs in 1999. The Yukos security services' involvement in both of these incidents was ascertained in law in a criminal conviction adjudged by the Moscow City Court on 13 November 2000.⁸⁴¹

543. Numerous observers have acknowledged the profoundly harmful effect caused to Russian society by the use of such violent methods: “*As a direct result of the attempt to introduce capitalism quickly and without a moral or legal framework, a criminal business oligarchy arose in Russia (. . .). [N]o individual is safe from [this oligarchy] if he interferes with the process by which it is stealing the Nation’s wealth. The result is that human rights are violated by the wielders of criminal oligarchical power on a massive scale.*”⁸⁴² During testimony in *Berezovsky v. Abramovich*, many of the participants likewise confirmed that oligarchs frequently used “criminal violence” during this period as a means of achieving business objectives.⁸⁴³

(a)(vi) *Conclusion*

544. For the reasons set forth above, the Russian Oligarchs’ acquisition of the Yukos shares was illegal based on fraud, collusion, conspiracy and corruption. They were assisted by public officials (the Red Directors), to whom the Russian Oligarchs (via YUL) paid many hundreds of millions in bribes. The Russian Oligarchs consolidated their control over the Yukos-group by illegitimate means, including abuses of corporate law and violent crimes.
545. These factual conclusions are vital to these appellate proceedings, as one of the annulment grounds concerns the question whether these illegitimately obtained shares in Yukos Oil Company could qualify as an “investment” by a foreign “investor”. The answer to both questions is “no”. As a result, HVY could not rely on Article 26 ECT and the Tribunal had no jurisdiction to decide this case (Jurisdiction Ground 2). Moreover, as will be explained in chapter VII.H, it is irreconcilable with public policy to award claims that arise out of crimes such as collusion, conspiracy and corruption (Public Policy Grounds 5 and 6).

⁸⁴¹ Resp. C-Mem. on the Merits (**Exhibit RF-03.1.B-3**) §§ 102, Judgment of the Moscow City Court Case No. 2-350/2000 dated 13 Nov. 2000 (RME-167).

⁸⁴² Statement of Satter at U.S. Commission on Security and Cooperation in Europe of 15 January 1999 (**Exhibit RF-306**).

⁸⁴³ See the decision rendered in the case *Berezovsky v. Abramovich* § 54(vi) (RME-4654).

(b) ***Phase 2 - The Russian Oligarchs created Hulley, YUL and VPL to conceal control over Yukos Shares and Evade Dividend Taxes.***⁸⁴⁴(b)(i) *Introduction*

546. Phase 2 of the Russian Oligarchs' criminal activities involved the concealment of their control over Yukos by shifting these shares in many stages to primarily Cyprus-based entities. These Cypriot entities were subsequently used for fraudulent tax evasion.⁸⁴⁵ The Tribunal accepted that the Russian Oligarchs had evaded taxes by abusing a tax treaty (the Russia-Cyprus DTA).⁸⁴⁶ As a result, dividends of at least USD 8 billion would remain almost untaxed.⁸⁴⁷
547. As the evidence further reflects, this tax evasion scheme was the sole reason why Hulley and VPL were actually established in Cyprus, and why the Russian Oligarchs ultimately made them the majority shareholders of Yukos. As reflected in the internal emails of Yukos executives, the only motivation for structuring financial transactions through Cypriot entities was that "*Cyprus ha[d] the necessary double taxation treaty.*"⁸⁴⁸
548. The current version of the Russia-Cyprus DTA was adopted in 1998, and entered into force on 1 January 2000.⁸⁴⁹ This treaty replaced a previous agreement (with similar benefits) adopted by the Soviet Union and Cyprus in 1982. The text of the 1998 Russia-Cyprus DTA is in large part identical to the OECD Model Convention on Income and Capital.⁸⁵⁰ The purpose of the treaty is to promote international trade and to permit genuine Cypriot

⁸⁴⁴ Final Awards, marginal no. 1291.

⁸⁴⁵ Final Awards marginal no. 1291.

⁸⁴⁶ See Final Awards, marginal nos. 1291 et seq., 1365, 1620 and 1621. The Tribunal concluded specifically (original English text): "*At the same time, it seems clear to the Tribunal, on the facts, that Yukos' operations under the DTA were wholly conducted by Mr. Lebedev from Yukos' established offices in Moscow, that his "place of management" where he habitually concluded contracts relating to operations under the Treaty was in Moscow, which of itself demonstrates that Yukos' avoidance of hundreds of millions of dollars in Russian taxes through the Cyprus-Russia DTA, was questionable.*" (Final Awards marginal 1620).

⁸⁴⁷ Expert Opinion Prof. Rosenbloom 2011, § 132; Expert Opinion Prof. Rosenbloom 2012, §§ 123 et seq.

⁸⁴⁸ Email from Bruce Misamore dated 17 June 2004 (RME-3819). [English original text]: "*Cyprus ha[d] the necessary double taxation treaty.*"

⁸⁴⁹ Russia-Cyprus Income and Capital Tax Agreement (Dec. 5, 1998).

⁸⁵⁰ Expert Opinion Prof. Rosenbloom 2011, §§ 71 et seq.

UNOFFICIAL TRANSLATION

This text is an unofficial translation of the Dutch original. In case of any discrepancies, the Dutch original shall prevail.

businesses to avoid the double taxation of their Russian income.⁸⁵¹ Obviously the purpose was not to reduce the dividend tax rate for regular Russian companies through round-trip diversion of funds.⁸⁵²

549. Hulley and VPL wrongfully claimed benefits under the Russia-Cyprus DTA to reduce the domestic dividend tax rate from 15% to 5%. As Hulley and VPL received at least USD 2.3 billion in dividends from Yukos, the benefits were substantial.⁸⁵³

550. Cyprus effectively did not levy any dividend taxes from any of the Yukos companies. Neither Hulley, nor VPL, nor any of the other Cyprus-based Yukos-companies paid “double taxation” that would justify reducing their tax rates.⁸⁵⁴ YUL also participated in this fraud by entering into numerous sham transactions involving the sale and repurchase of Yukos shares back and forth to Hulley and VPL (see section §§ 562 - 568 below).⁸⁵⁵

551. The tax evasion is clarified in the graph below:

⁸⁵¹ See Resp. C-Mem. on the Merits (**Exhibit RF-03.1.B-3**) §§ 115 and 155. Prof. Rosenbloom explained: “*The primary purpose of a tax treaty is to promote international trade by removing any ‘obstacles that double taxation presents to the development of economic relations between countries.’ [...] [T]ax treaties are designed to mitigate ‘the most common problems that arise in the field of international juridical double taxation.’*” Expert Opinion Prof. Rosenbloom 2011, § 78.

⁸⁵² Expert Opinion Prof. Rosenbloom 2011, §§ 79; Expert Opinion Prof. Rosenbloom 2012, §§ 123-126.

⁸⁵³ Expert Opinion Prof. Rosenbloom 2011, §§ 26; Expert Opinion Prof. Rosenbloom 2012, §§ 21-27.

⁸⁵⁴ Expert Opinion Prof. Rosenbloom 2012, § 79.

⁸⁵⁵ See Final Awards, marginal no. 1293 and Resp. Rej. on the Merits (**Exhibit RF-03.1.B-5**) §§ 1435-1436.

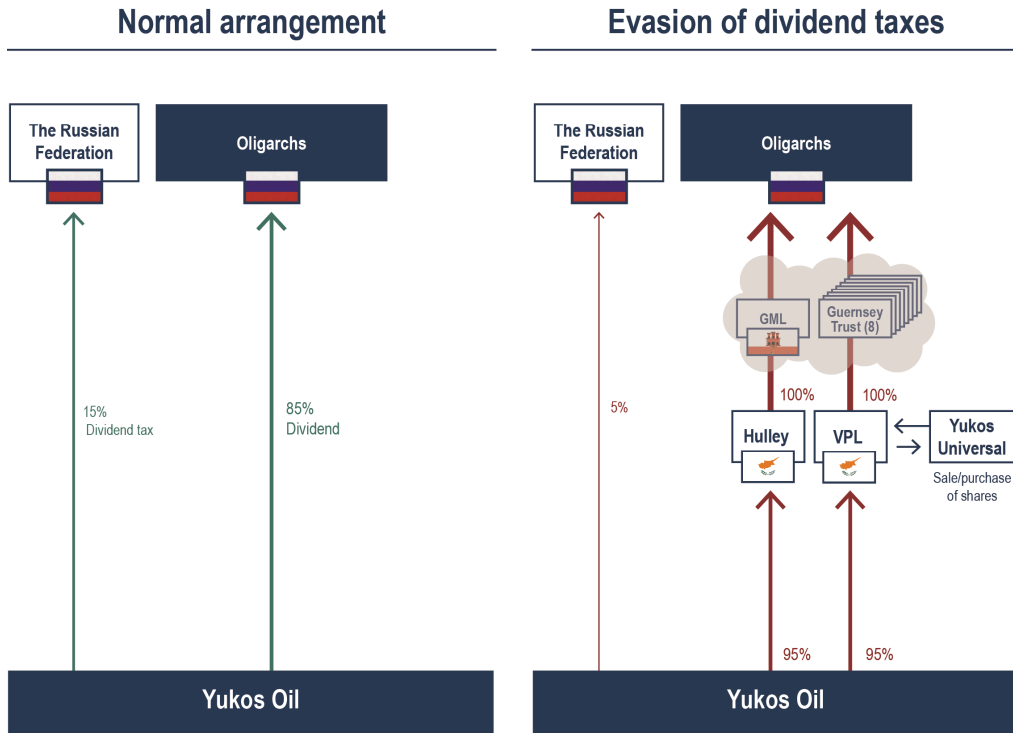

552. The Russian Oligarchs systematically abused the DTA with respect to many levels of the Yukos structure.⁸⁵⁶ In addition to Hulley and VPL, which were Yukos *shareholders*, the Russian Oligarchs also created numerous Yukos *subsidiaries* in Cyprus. This was done for no other reason than to reduce the domestic Russian dividend tax from 15% to 5%. As dividends worth at least USD 6 billion were paid out to Cypriot *subsidiaries*, the benefits of this unlawful tax evasion were substantial (see section § 569 - 574 below).⁸⁵⁷

553. Whilst the Tribunal refused to address most of the Russian Oligarchs' illegal activities,⁸⁵⁸ the Tribunal did rule expressly that HVY had fraudulently abused the Russia-Cyprus DTA.⁸⁵⁹ HVY have not contested this finding, nor identified any alternative reason (other than tax evasion or money laundering) for the incorporation of Hulley and VPL in Cyprus.

⁸⁵⁶ See Final Awards, marginal nos. 1291-1306.

⁸⁵⁷ See Final Awards, marginal no. 1293 and Resp. Rej. on the Merits (**Exhibit RF-03.1.B-5**) §§ 1435-1436.

⁸⁵⁸ See § 509 above.

⁸⁵⁹ See Final Awards, marginal nos. 1291 et seq., 1365, 1620 and 1621. The Tribunal considered specifically [English original text]: "At the same time, it seems clear to the Tribunal, on the facts, that Yukos' operations under the DTA were wholly conducted by Mr. Lebedev from Yukos' established offices in

554. The individual parts of the Russian Oligarchs' illegal tax evasion are detailed below (Phase 2).

(b)(ii) The Russian Oligarchs' Movement of Their Yukos Shares to Cyprus

555. After obtaining more than 78% of the shares in Yukos in 1995 and 1996, the Russian Oligarchs then began to move their shares in Yukos through several layers of Russian and offshore shell companies toward their final destination in Cyprus.⁸⁶⁰

556. By March 1998, more than 1 billion shares in Yukos had been collected in Cyprus by a group of Hulley's subsidiaries.⁸⁶¹ In April 2000, the Russian Oligarchs then transferred these shares in Yukos specifically to Hulley itself.⁸⁶² In 2001, an additional 223 million shares in Yukos were transferred to VPL. VPL was likewise based in Cyprus.⁸⁶³

557. Notably, the Russian Oligarchs transferred shares in Yukos in small proportions from one sham company to another until they finally ended up in Cyprus. As detailed in Professor Kothari's expert reports, this is a classic money-laundering technique known as "structuring" or "smurfing".⁸⁶⁴

"These terms refer to 'the act of dividing a large sum into small amounts, [and] making a series of small payments' in order to 'avoid[] drawing attention to the individual payments and keeping them below the minimum amount that requires the transaction not to be reported to a monitoring body.'⁸⁶⁵ According to the OECD, this technique is employed wherever 'a series of related transactions (...) could have been conducted as one transaction, but (...) has been broken into several transactions by the financial institution and/or the parties to the transaction intentionally (...) for purposes of circumventing transaction reporting requirements.'⁸⁶⁶ As these definitions

Moscow, that his "place of management" where he habitually concluded contracts relating to operations under the Treaty was in Moscow, which of itself demonstrates that Yukos' avoidance of hundreds of millions of dollars in Russian taxes through the Cyprus-Russia DTA, was questionable." (Final Awards, marginal no. 1620).

⁸⁶⁰ Resp. C-Mem. on the Merits (**Exhibit RF-03.1.B-3**) §§ 1589 et seq.

⁸⁶¹ Expert Opinion Prof. Kothari 2015 (**Exhibit RF-202**) §§ 26-39.

⁸⁶² Expert Opinion Prof. Kothari 2015 (**Exhibit RF-202**) §§ 40-44.

⁸⁶³ Expert Opinion Prof. Kothari 2017 (**Exhibit RF-D15**) § 66.

⁸⁶⁴ Expert Opinion Prof. Kothari 2017 (**Exhibit RF-D15**) §§ 15, 35-39.

⁸⁶⁵ Roberto Durrieu, *Rethinking Money Laundering & Financing of Terrorism in International Law*, Martinus Nijhoff, (2013), p. 32.

⁸⁶⁶ OECD, Joint Audit Report, Sixth Meeting of the OECD Forum on Tax Administration (Sept. 15-16,

reflect, the essential purpose of using of ‘structuring’ or ‘smurfing’ is to complicate forensic analysis of financial or accounting records and disguise the true nature of the underlying transactions.”⁸⁶⁷

558. This understanding was confirmed by Mr. Anilionis, who explained that this offshore structure of companies had several purposes.

559. First, the transactions were intended to conceal the actual ownership and control of the Russian Oligarchs over the shares in Yukos. The purpose of the smaller "smurfing" transactions was to circumvent requirements for disclosures and regulatory approvals.⁸⁶⁸ As Professor Asoskov explains, these concealed, structured transactions violated both Law No. 948-I on Competition and Law No. 208-FZ on Joint Stock Companies.⁸⁶⁹

560. Second, this structure was intended to evade the Russian Oligarchs’ tax obligations. Mr. Anilionis:

"9. (...) None of these companies created any products, provided any services, or conducted any other business activity of their own. They were used only to provide corporate structures to hold assets, loans, and revenue from OAO Yukos Oil Company and the other holdings of the group. They had no independent existence of their own. As I understood the offshore structure, it was created to conceal the actual ownership of companies and other assets obtained by Bank Menatep and ZAO Rosprom through privatization related auctions, and to create a corporate structure that would reduce the group’s tax obligations. (...)"⁸⁷⁰

561. Indeed, neither Hulley nor VPL ever conducted any genuine business activity in Cyprus other than holding shares in Yukos and extracting Yukos dividends or other disbursements from the Russian Federation.

(b)(iii) The Abuse of the Russia-Cyprus DTA

562. Dividends paid by a Russian subsidiary (Yukos) to its Cypriot parent company (Hulley and VPL) are ordinarily taxed at a rate of 15%. Article 10 of the Russia-Cyprus DTA provides

2010), § 73 n.42.

⁸⁶⁷ Expert Opinion Prof. Kothari 2017 (**Exhibit RF-D15**) § 35.

⁸⁶⁸ Anilionis Declaration (**Exhibit RF-200**), § 7.

⁸⁶⁹ Expert Opinion Prof. Asoskov 2015 (**Exhibit RF-203**) §§ 49-52.

⁸⁷⁰ Anilionis Declaration (**Exhibit RF-200**), § 9 (emphasis added).

for a lower tax rate of 5%.⁸⁷¹ The Russian Oligarchs filed tax forms on behalf of Hulley and VPL, claiming the lower tax rate of 5% with respect to at least USD 2.3 billion in dividends on the shares in Yukos.⁸⁷²

563. During the Arbitration, the Russian Federation filed an expert report by Prof. Dr. Stef van Weeghel. Prof. van Weeghel is a professor of international tax law at the law faculty of the University of Amsterdam and research fellow at the Amsterdam Center for International Law.⁸⁷³ Prof. van Weeghel confirmed that neither Hulley nor VPL was entitled to the lower dividend tax rate of 5% and that their tax filings were "*clearly erroneous*":

"[T]he claim made by Hulley in tax returns for 2000 and 2001 that the dividend income from Yukos was not connected with activities carried out in the Russian Federation is clearly erroneous (...) Hulley was not entitled to a reduced rate of Russian tax in respect of the dividends, which it claimed on the basis of Article 10 of the Russia-Cyprus DTC (...)

VPL was not entitled to a reduced rate of Russian tax in respect of the dividends, which it clearly erroneously claimed on the basis of Article 10 of the Russia-Cyprus DTC."⁸⁷⁴

564. In order to be eligible for the lower tax rate, a number of conditions had to be met.⁸⁷⁵ For present purposes, the three most relevant requirements are:

- (a) the parent company (i.e. Hulley and VPL) has to be resident of Cyprus;

⁸⁷¹ Article 10 stipulates: "*1. Dividends paid by a company which is a resident of a Contracting State to a resident of the other Contracting State may be taxed in that other State. 2. However, such dividends may also be taxed in the State of which the company paying the dividends is a resident and according to the laws of that State, but if the beneficial owner of the dividends is a resident of the other State, the tax so charged shall not exceed: 5% of the gross amount of the dividends....*" See also Final Awards, marginal no. 1292.

⁸⁷² Expert Opinion Prof. Rosenbloom 2011, §§ 26; Expert Opinion Prof. Rosenbloom 2012, §§ 18-26.

⁸⁷³ Expert Opinion Prof. van Weeghel 2007, p. 36.

⁸⁷⁴ Note that Prof. van Weeghel uses the term DTC, which stands for Double Tax Convention. This is exactly the same as the Double Taxation Agreement. Expert Opinion Prof. van Weeghel 2007, p. 36. Original English text: "*[T]he claim made by Hulley in tax returns for 2000 and 2001 that the dividend income from Yukos was not connected with activities carried out in the Russian Federation is clearly erroneous (...) Hulley was not entitled to a reduced rate of Russian tax in respect of the dividends, which it claimed on the basis of Article 10 of the Russia-Cyprus DTC (...) VPL was not entitled to a reduced rate of Russian tax in respect of the dividends, which it clearly erroneously claimed on the basis of Article 10 of the Russia-Cyprus DTC.*"

⁸⁷⁵ See Expert Opinion Prof. van Weeghel 2007, § 3.4.

- (b) the Cypriot parent company (i.e. Hulley and VPL) should be the "beneficial owner" of the dividend income; and
- (c) the parent company (i.e. Hulley and VPL) should not have a "permanent establishment" in Russia, to which the dividend income is attributable.⁸⁷⁶

565. In fact, Hulley and VPL did not meet any of the three cumulative criteria.⁸⁷⁷

- (a) The first requirement implies that the parent companies Hulley and VPL should be managed and controlled in Cyprus.⁸⁷⁸ Both Hulley and VPL falsely claimed to have fulfilled these conditions. The companies were owned and controlled by the Russian Oligarchs in the Russian Federation. In their tax filings, they misrepresented that *"the above mentioned income is not connected with activities carried out in the Russian Federation."*⁸⁷⁹
- (b) Hulley and VPL filed treaty-related forms in which they claimed to be the *"beneficial owner[s]"* of the dividend received from Yukos.⁸⁸⁰ This claim was false: in reality the Russian Oligarchs were the beneficial owners of the dividend income.⁸⁸¹

⁸⁷⁶ See Resp. C-Mem. on the Merits (**Exhibit RF-03.1.B-3**) § 160, Article 10 of the Russia-Cyprus DTA, Expert Opinion Prof. van Weeghel 2007, § 3.4.

⁸⁷⁷ See Resp. C-Mem. on the Merits (**Exhibit RF-03.1.B-3**) §§ 119 et seq.

⁸⁷⁸ See Expert Opinion Prof. van Weeghel 2007, § 3.5. "[I] ... do express strong reservations on this point, as I understand that residence in Cyprus is based on 'management and control' in Cyprus and in view of the observations made in Part 2, I find it highly unlikely that management and control were indeed exercised there."

⁸⁷⁹ See Resp. C-Mem. on the Merits (**Exhibit RF-03.1.B-3**) §§ 134-153, 164; Resp. Rej. on the Merits (**Exhibit RF-03.1.B-5**) § 1449 and Final Awards, marginal no. 1295. See further e.g. Hulley Enterprises Limited, Claims for an exemption of Passive Incomes Sources in Russia before the Payment is Made (Form 1013DT) for 2000, 2001 (RME-193) (English and Russian); VPL Petroleum Limited, Claims for an Exemption of Passive Incomes sourced in Russia before the Payment is Made (Form 1013 DT) for 2001, 2002 (RME-194) (English and Russian). See also Hulley Enterprises Limited, Annual Report and Financial Statements for the year ended Dec. 31, 2003 (Apr. 7, 2004) (RME-190); VPL Petroleum Limited, Annual Report and Financial Statements for the year ended Dec. 31, 2003 (Dec. 15, 2006) (RME-192).

⁸⁸⁰ See Ibid.

⁸⁸¹ See Resp. C-Mem. on the Merits (**Exhibit RF-03.1.B-3**) §§ 161-165 and Resp. Rej. on the Merits (**Exhibit RF-03.1.B-5**) § 1448. See Expert Opinion Prof. Rosenbloom 2011, § 94. [English original text]:

- (c) The treaty requires that the recipient of the dividend income does not have a permanent establishment in Russia to which the dividend income is attributable. This requirement was not met. Contrary to what Hulley and VPL have declared, neither had substantial business activities in Cyprus and both were at all times owned, controlled and managed by the Russian Oligarchs from their permanent establishment in the Russian Federation.⁸⁸²

566. The facts are slightly different with regards to YUL. Where Hulley and VPL pretended to be based in Cyprus, YUL was based in the Isle of Man. Nevertheless, the Russia-Cyprus DTA was abused via YUL. Shortly before Yukos would pay dividends, YUL would consistently sell its shares in Yukos to Hulley and VPL, which shares would then – after the dividend had been paid – be resold to YUL.⁸⁸³ For example, on 25 April 2001, YUL transferred 205,549,312 shares to Hulley for USD 575,538,073.⁸⁸⁴ On the same date as that transaction, YUL paid Hulley USD 1 for the option to repurchase all of those shares for a predetermined price of USD 575,825,850 within three months (USD 287,777 more than paid by Hulley on April 25).⁸⁸⁵ Then, on 7 May 2001, YUL exercised its option to repurchase all of those shares. This was just three days after Hulley had received a USD

"Treaty benefits are denied when they economically benefit a person not entitled to a treaty who uses an agent, nominee, or conduit company to act as an intermediary between himself and the payer of the income." See Expert Opinion Prof. van Weeghel 2007, p. 24 [English original text]: "It follows from the OECD Commentary that a "nominee" does not qualify for beneficial ownership. In this respect, it is observed that the term "nominee" used in the above cited paragraph 12 would for purposes of international tax law generally refer to a person holding Legal title of property for the benefit of another person. Thus, it should be evident that a person acting as nominee in respect of dividend income does not fulfil the beneficial ownership requirement as included in (provisions based on) Article 10 of the OECD Model Tax Convention. Following [these] observations (...), VPL, while holding legal title to the Yukos shares at the time of the dividend distribution, in the Relevant Period held these shares as a mere nominee. Given the explicit requirement of beneficial ownership in Article 10(2) of the Russia-Cyprus DTC and in view of the fact that a nominee does not qualify as a beneficial owner of dividends, the conclusion must be that VPL in the Relevant Period was not a beneficial owner of the Yukos dividends and was therefore not entitled to benefits it claimed under the DTC ."

⁸⁸² See e.g. Claimants' Counter-Memorial on Jurisdiction and Admissibility (Hulley), § 288 ("The Claimant [...] acknowledges that it has no substantial business activity in Cyprus"). See also Resp. Rej. on the Merits (**Exhibit RF-03.1.B-5**) § 193 and Final Awards, marginal no. 1297. See Expert Opinion Prof. van Weeghel 2007, § 3.6(d), p. 23; Expert Opinion Prof. Rosenbloom 2011, §§ 125, 131-132.

⁸⁸³ See Resp. C-Mem. on the Merits (**Exhibit RF-03.1.B-3**) §§ 177-188.

⁸⁸⁴ See Sales Agreement No. Y-H/1-2001 between Hulley Enterprises Limited and Yukos Universal Limited (Apr. 25, 2001) (RME-216).

⁸⁸⁵ See Option Agreement #H-Y/07-2001 between Hulley Enterprises Limited and Yukos Universal Limited (Apr. 25, 2001) (RME-217).

18,316,499 dividend distribution for her short-lived possession of these shares in Yukos.⁸⁸⁶

In the repurchase of her shares YUL booked a negligible profit, but missed out on a stiff amount of dividends.⁸⁸⁷

567. The only intention of this abusive scheme was to take advantage of the Russia-Cyprus DTA. The Russian Federation filed an expert report in the Arbitrations by Prof. H. David Rosenbloom, Visiting Professor of Taxation at New York University School of Law.⁸⁸⁸ Prof. Rosenbloom concludes that YUL and Hulley's "*circular transactions*" represent "*abusive tax avoidance*":

“[S]uch circular transactions in which Hulley held Yukos shares only temporarily represents abusive tax avoidance.”⁸⁸⁹

568. The Tribunal correctly established that HVY evaded taxes by abusing the Russia-Cyprus Double Tax Agreement. The Tribunal held that Mr. Lebedev – one of the Russian Oligarchs – filed false tax forms on behalf of Hulley:

"It seems clear to the Tribunal, on the facts, that Yukos' operations under the DTA were wholly conducted by Mr. Lebedev from Yukos' established offices in Moscow, that his "place of management" where he habitually concluded contracts relating to operations under the Treaty was in Moscow, which of itself demonstrates that Yukos' avoidance of hundreds of millions of dollars in Russian taxes through the Russia-Cyprus DTA, was questionable. Hulley appears to the Tribunal to have falsely declared on Cypriot withholding tax forms that "income"—dividends from Yukos—"was not connected with activities carried on in the Russian Federation" despite Mr. Lebedev's activities in Moscow"⁸⁹⁰ [emphasis added]

(b)(iv) *The Russian Oligarchs' Other Abuses of the Russia-Cyprus DTA*

569. The Russian Oligarchs – assisted by Mr. Anilionis, Mr. Zakharov, and other RTT employees⁸⁹¹ – created a vast network of sham companies in numerous jurisdictions. Some

⁸⁸⁶ See Letter from Yukos Universal Limited to Hulley Enterprises Limited re: Option Agreement of 25th day of April 2001 (May 7, 2001) (RME-218).

⁸⁸⁷ See Sales Agreement No. YH/ 2-2001 between Hulley Enterprises Limited and Yukos Universal Limited (May 7, 2001) (RME-219). See generally Resp. C-Mem. on the Merits (**Exhibit RF-03.1.B-3**) § 177 and Supplemental Expert Report of Thomas Z. Lys ("Lys Report"), §§ 55-77.

⁸⁸⁸ See Expert Opinion Prof. Rosenbloom 2011, p. 1.

⁸⁸⁹ See Expert Opinion Prof. Rosenbloom 2011, § 114.

⁸⁹⁰ See Final Awards, marginal no. 1620.

⁸⁹¹ See e.g. Pleading Notes RF dated 9 February 2016, §§ 46 et. seq.

of those companies were direct or indirect subsidiaries of Yukos, which allowed the Russian Oligarchs to channel Yukos cash flows through low-tax jurisdictions both within the Russian Federation and offshore. Many sham companies were based in Cyprus. Those companies were also involved in the abuse of the Russia-Cyprus DTA, with respect to more than USD 6 billion in dividends.⁸⁹²

570. As is explained in detail below (see § 578-595), Yukos' vast network of sham companies was simultaneously engaged in a massive domestic tax fraud that caused certain sham companies in the Russian Federation's low tax regions to report billions in profits. In most instances, the vast profits of these companies were siphoned out of the Russian Federation through an extensive offshore structure.⁸⁹³

571. As set out in the Arbitrations, the dividends from Russian sham companies were generally paid to Cypriot "parent companies" within the Yukos structure.⁸⁹⁴ In order to evade dividend taxes, these companies would abuse the Russia-Cyprus DTA in much the same way as Hulley and VPL did. Most of the dividends paid out to these Cyprus sham companies would subsequently be funneled away to Yukos companies that were established on the British Virgin Islands.⁸⁹⁵

572. In his first expert report, Prof. Rosenbloom discussed two examples of Yukos subsidiaries that abused the Russia-Cyprus DTA. These companies received dividends amounting to (at least) USD 4.3 billion. These examples concern the Cypriot companies Dunsley and Nassaubridge:

- (a) Dunsley. In 2001, Dunsley acquired a 100 percent interest in Ratibor, a corporation located in a low-tax region within the Russian Federation. For 2003, Ratibor distributed more than USD 800 million in dividends to Dunsley.⁸⁹⁶ Dunsley claimed benefits under the Russia-Cyprus DTA with

⁸⁹² Expert Opinion Prof. Rosenbloom 2012, §§ 159-164; PWC Email dated 17 June 2004 (RME-2096); PWC Email dated 24 June 2004 (RME-2097); PWC Email dated 14 July 2004 (RME-2098).

⁸⁹³ See Resp. C-Mem. on the Merits (Exhibit RF-03.1.B-3) § 266-269.

⁸⁹⁴ See e.g. Resp. C-Mem. on the Merits (Exhibit RF-03.1.B-3) § 246 et seq.

⁸⁹⁵ Resp. C-Mem. on the Merits (Exhibit RF-03.1.B-3) §§ 266-269.

⁸⁹⁶ Expert Opinion Prof. Rosenbloom 2011, p. 17-18; Dunsley Financial Statements dated 31 December 2003, p. 9 (RME-272); *see also* PWC Email dated 17 June 2004 (RME-2096); PWC Email dated 24 June 2004 (RME-2097); PWC Email dated 14 July 2004 (RME-2098).

respect to these dividends. Dunsley in turn paid out the dividends to its parent corporation, a Yukos subsidiary on the British Virgin Islands.⁸⁹⁷

- (b) Nassaubridge. In 2001, Nassaubridge acquired a 100 percent interest in Fargoil, a Russian corporation located in a low-tax region within the Russian Federation. In 2002, Fargoil distributed more than USD 1 billion in dividends to Nassaubridge.⁸⁹⁸ In 2003, Fargoil distributed dividends amounting to USD 2.6 billion to Nassaubridge. Both years, Nassaubridge claimed benefits under the Russia-Cyprus DTA. Nassaubridge in its turn paid out the dividends to its parent corporation, a Yukos subsidiary in the British Virgin Islands.⁸⁹⁹

573. Prof. Rosenbloom concluded that Dunsley and Nassaubridge did not meet the criteria for a lower dividend tax rate under the Russia-Cyprus DTA, even though both companies claimed to be eligible for the lower dividend tax rate of 5% in the Russian Federation.⁹⁰⁰ In a similar manner as described previously for Hulley and VPL, Dunsley and Nassaubridge were not the ultimate beneficiary to the dividend income,⁹⁰¹ nor were they truly Cypriot companies,⁹⁰² while they did in fact have permanent residences in Russia⁹⁰³:

"Analysis of the Yukos structure demonstrates that Dunsley and Nassaubridge were not beneficial owners of dividends received from Ratibor and Fargoil (...) Since Dunsley and Nassaubridge were not the beneficial owners of the dividends they received from Yukos affiliates, they were not entitled to Convention based reductions of Russian tax.

(...) The same analysis suggests that both Dunsley and Nassaubridge had permanent establishments in Russia through the activities of dependent agents.

⁸⁹⁷ Expert Opinion Prof. Rosenbloom 2011, p. 17-18.

⁸⁹⁸ Expert Opinion Prof. Rosenbloom 2011, p. 19-20; Nassaubridge Management Limited, Report and Financial Statements, December 31, 2002, pp. 6 and 16 (RME-3149); Nassaubridge Financial Statements dated December 31, 2003, pp. 9 and 16 (RME-2136); *see also* PWC Email dated 17 June 2004 (RME-2096); PWC Email dated 24 June 2004 (RME-2097); PWC Email dated 14 July 2004 (RME-2098).

⁸⁹⁹ Expert Opinion Prof. Rosenbloom 2011, p. 19-20.

⁹⁰⁰ Dunsley Limited, Report and Financial Statements, 31 December 2003, at 9, 16 (RME-1967) (reflecting payment of 5% tax on dividends); *see also* Nassaubridge Management Limited, Report and financial statements, 31 December 2003, at p. 9 (RME-1969) (also reflecting payment of 5% tax on dividends).

⁹⁰¹ Expert Opinion Prof. Rosenbloom 2011, § 51 and 60.

⁹⁰² Expert Opinion Prof. Rosenbloom 2011, §§ 54-55 and 61.

⁹⁰³ Expert Opinion Prof. Rosenbloom 2011, § 153 et seq.

(...) As a result, dividends received by Nassaubridge from Fargoil were business profits attributable to a Russian permanent establishment pursuant to Article 7 of the Convention (...)”⁹⁰⁴

574. In his second report, Prof. Rosenbloom discussed four other examples of Cypriot companies that wrongfully claimed advantages under the Russia-Cyprus DTA with respect to an additional USD 1.6 billion of dividends. These were the companies known as Glenoaks, Hicksville, Coastmill, and Silkmillennium.⁹⁰⁵ Much like Dunsley and Nassaubridge, these subsidiaries received dividends from Russian sham companies such as OOO Forest-Oil, OOO Vald Oil, OOO Business-Oil and OOO Alta-Trade.⁹⁰⁶ These Yukos entities were also managed and controlled by the Russian Oligarchs.⁹⁰⁷ They falsely claimed benefits under the Russia-Cyprus DTA⁹⁰⁸ whilst they did not meet the criteria to be eligible for the lower tax rate of 5%.⁹⁰⁹

(b)(v) Conclusion

575. The Russian Oligarchs thus abused the Russia-Cyprus DTA at multiple levels in the Yukos structure to falsely claim lower tax rates. Professor Rosenbloom concludes that there was a pattern of tax treaty abuse, whereby paper entities were used to claim substantial treaty benefits without any merit:

"Analysis of the Yukos structure reveals a pattern of tax treaty abuse and a reliance upon paper entities to claim substantial treaty benefits. Even putting abuse aside, the claims were not in accordance with the terms of the Convention. Those claims were utterly without merit."⁹¹⁰

⁹⁰⁴ Expert Opinion Prof. Rosenbloom 2011, §§ 116, 124 and 134 (emphasis added).

⁹⁰⁵ Expert Opinion Prof. Rosenbloom 2012, p. 32-41 and Resp. Rej. on the Merits (**Exhibit RF-03.1.B-5**) § 590; see also Glenoaks Financial Statements dated 31 December 2002 (RME-3016); Hicksville Financial Statements dated 31 December 2002 (RME-3017); Silkmillennium Financial Statements dated 31 December 2002 (RME-3036); Coastmill Financial Statements dated 31 December 2002 (RME-3035); see also PWC Email dated 17 June 2004 (RME-2096); PWC Email dated 24 June 2004 (RME-2097); PWC Email dated 14 July 2004 (RME-2098).

⁹⁰⁶ See Resp. Rej. on the Merits (**Exhibit RF-03.1.B-5**) § 590; PWC Email dated 17 June 2004 (RME-2096); PWC Email dated 24 June 2004 (RME-2097); PWC Email dated 14 July 2004 (RME-2098).

⁹⁰⁷ See Resp. Rej. on the Merits (**Exhibit RF-03.1.B-5**), footnote 2507.

⁹⁰⁸ Tax Forms 1013DT (Glenoaks) (RME-3006); Tax Forms 1013DT (Hicksville) (RME-3007); Tax Forms 1013DT (Coastmill) (RME-3028); Tax Forms 1013DT (Silkmillennium) (RME-3029).

⁹⁰⁹ See Expert Opinion Prof. Rosenbloom 2012, §§ 159 et seq.

⁹¹⁰ Expert Opinion Prof. Rosenbloom 2011, §§ 116, 124 and 134.

576. Notably, the ECT arbitrators expressly agreed with Professor Rosenbloom's analysis.⁹¹¹ In their pleadings before this Court and the District Court of The Hague, HVY have not contested the ECT arbitrators' finding, or put forward any alternative reason (other than fraudulent tax evasion and money laundering) for the Russian Oligarchs' incorporation of Hulley and VPL specifically in Cyprus.
577. HVY are mere letterbox companies controlled by Russians in the Russian Federation. They have been set up for no other purpose than tax evasion. These factual conclusions are of great importance to these appellate proceedings. For example, in chapter IV.C(b), it will be explained that this case does not concern foreign investments (Jurisdiction Ground 2). The Tribunal wrongly assumed jurisdiction over a purely internal Russian dispute between Russian Oligarchs and the Russian Federation.

(c) ***Phase 3 - The Russian Oligarchs Abused Shell Companies to Commit Tax Fraud in the Russian Federation's Low-Tax Regions (1996-2004)***

(c)(i) *Introduction*

578. The third category of the Russian Oligarchs' illegal conduct concerns the abuse of sham companies based in the Russian Federation's low-tax jurisdictions. The abuse was aimed at evading taxes relating to the multibillion-dollar revenues from the sale of oil.⁹¹²
579. The virtually untaxed profits of these sham companies were then partially transferred back to Yukos itself, for example as a series of "unilateral gifts."⁹¹³ Finally, these funds were then transferred to the Russian Oligarchs as dividends paid through HVY.⁹¹⁴

(c)(ii) *The methods used by the Russian Oligarchs' to engage in Sham Transactions*

580. As explained by Mr. Anilionis and Mr. Zakharov, the Russian Oligarchs directed the RTT employees to assist in setting up a massive tax evasion scheme. The RTT employees would establish shell companies in the low-tax jurisdictions of the Russian Federation, including

⁹¹¹ See Final Awards, marginal nos. 1291 et seq., 1365, 1620 and 1621.

⁹¹² See Final Awards, marginal no. 1307; see also Resp. Rej. on the Merits (**Exhibit RF-03.1.B-5**) § 1435.

⁹¹³ First ECtHR Ruling (RME-3328), §§ 592-593.

⁹¹⁴ See, e.g., Hulley Annual Report for 2003 dated 7 April 2004 (RME-190); VPL Annual Report and Financial Statements for 2003 dated 15 December 2006 (RME-192).

UNOFFICIAL TRANSLATION

This text is an unofficial translation of the Dutch original. In case of any discrepancies, the Dutch original shall prevail.

Mordovia, Kalmykia, Lesnoy, Trekhgorny, Sarov, and Evenkia. The RTT employees, or other intermediaries, would then conclude contracts to sell OAO Yukos Oil Company's crude oil to the companies in these low-tax regions and offshore tax havens at below-market prices. The crude oil would then be sold to end customers at market prices, which led the Russian Oligarchs to wrongly report profits in the low-tax regions or in offshore jurisdictions, with beneficial tax consequences."⁹¹⁵

581. The scheme went through several iterations, and evolved over time. Different shell companies were used in 2000,⁹¹⁶ 2001,⁹¹⁷ 2002,⁹¹⁸ 2003 and 2004.⁹¹⁹ The documentary record reflects that specific RTT employees or their relatives were involved in either the management or the creation of virtually all of the sham companies used in this scheme.⁹²⁰ This specifically concerns Mr. Khvostikov,⁹²¹ Mr. Kraynov,⁹²² Mr. Koval,⁹²³ Mr.

⁹¹⁵ See Anilionis Declaration (**Exhibit RF-200**), §§ 34-37; Zakharov Declaration (**Exhibit RF-201**) §§ 16-17.

⁹¹⁶ See Final Awards marginal nos. 326-483, Resp. C-Mem. on the Merits (**Exhibit RF-03.1.B-3**), §§ 230-255 and 281-287. In 2000, the following Trading Shells were used by YUKOS: OOO Ratmir (previously known as Pluton XXVI); OOO Alta-Trade (previously known as Mercury XXIII); ZAO YUKOS-M; OOO Yu-Mordovia; OOO Mars-XII; OOO Saturn XXV; OOO Yupiter XXIV (all registered in Republic of Mordovia); OOO Petrnieurn Trading (Evenk Atnomous Okrtig); OOO Yuksar (ZATO Arov); OOO Sihirskaya Transportnaya Kompaniya (Republic of Kalmykia); OOO Kverkus; OOO Muscron; OOO Plast; OOO Nurteks; OOO Grace; OOO Colrein; OOO Virtus (all registered in ZATO Trekhgorniy); OOO Staf; OOO Mitra; OOO Vald-Oil; OOO Business-Oil (all registered in ZATO Lesnoy).

⁹¹⁷ See Final Awards marginal nos. 326-483, Resp. C-Mem. on the Merits (**Exhibit RF-03.1.B-3**), §§ 230-255 and 281-287. In 2001, the following Trading Shells were used by YUKOS: OOO Ratmir; OOO Alta-Trade; ZAO YUKOS-M; OOO Yu-Mordovia; OOO Mars XXII; OOO Fargoil (all Republic of Mordovia); OOO Ratibor (Evenk Autonomous Okrug); OOO Mega Alyans (City of Baikonur).

⁹¹⁸ See Final Awards marginal nos. 326-483, Resp. Count. Mem., §§ 230-255 and 281-287. In 2002, the following Trading Shells were used by YUKOS: OOO Ratmir; OOO Altra-Trade; ZAO YUKOS.M; OOO Yu-Mordovia; OOO Fargoil (all Republic of Mordovia); OOO Ratibor; OOO Petroleum-Trading; OOO Evoil (all Evenk Autonomous Okrug).

⁹¹⁹ See Final Awards marginal nos. 326-483, Resp. Count. Mem. §§ 230-255 and 281-287. In 2003, the following Trading Shells were used by YUKOS: OOO Ratmir; OOO Altra-Trade; ZAO YUKOS-M; OOO Yu-Mordovia; OOO Fargoil; OOO Mars XXII (renamed OOO Energotrade); OOO Makro-Trade (all Republic of Mordovia); OOO Evoil (Evenk Autonomous Okrug).

⁹²⁰ See List of RTT Employees dated 1 September 1995 (**Exhibit RF-225**, Annex R-003); Anilionis Declaration (**Exhibit RF-200**), §§ 34-37; Zakharov Declaration (**Exhibit RF-200**), §§ 16-17.

⁹²¹ Moscow Arbitrazh Court 29 June 2004 (C-121), p. 9 "O.I. Khvostikov – Head of Vokit OOO (shareholder of Muskron OOO and Square OOO, Trekhgorny), Head of Business-Oil OOO (Lesnoy), Head of Vald-Oil OOO, Head of Elbrus OOO, which is the founder of ZAO Yukos-M and Yu-Mordovia OOO (Republic of Mordovia)."

Kobzar,⁹²⁴ Mr. Gorbunov,⁹²⁵ as well as two brothers of Mr. Zakharov and Mr. Koval.⁹²⁶

The shell companies were Yukos related entities, moreover, because they were owned directly or indirectly by offshore shell companies or trusts located in Cyprus and the BVI, including Dunsley, Nassaubridge, Glenoaks, Hicksville, Silkmillenium, and Coastmill (as discussed above).⁹²⁷

582. In this Defence on Appeal, the Russian Federation further explains the sham character of the Mordovian entities (see § 1124-1132). These entities had no purpose other than tax evasion. They were formally created and directed by strawmen that were not even aware that they held such positions at Yukos companies in reality. For example, the alleged director of Mars XXII, A.V. Tsigura testified he did not remember “*whether the company operated in 2000*”, neither whether he had “*entered into contracts as the General Director*” nor how long he was the General Director and who took the decision to dismiss him. A putative director of OOO Makro Trade, Y.Y. Egerov testified “*In 2001, I gave my passport to Vitaly Vladimirovich Reva (V. V. Reva) for registration of a firm, with the aim to*

⁹²² Moscow Arbitrazh Court 29 June 2004 (C-121), p. 9 “*A.V. Kraynov – Director of Akra OOO, shareholder of Bark OOO, Akra OOO and A-Trust OOO, Director of Business-Oil OOO*”.

⁹²³ Moscow Arbitrazh Court 29 June 2004 (C-121), p. 9 “*Andrei Vasiliyevich Koval – founder of Vokit OOO, Dnepr OOO and General Director of Mitra OOO (Lesnoy)*”.

⁹²⁴ Moscow Arbitrazh Court 29 June 2004 (C-121), p. 9 “*Yu.A. Kobzar – founder of A-Trust OOO, Vokit OOO and Dnepr OOO, and Director of Rasin OOO (founder of Business Oil OOO, Lesnoy)*”.

⁹²⁵ Moscow Arbitrazh Court 29 June 2004 (C-121), p. 9 “*E.E. Gorbunov – General Director of A-Trust OOO (founder of Alta-Trade OOO, Republic of Mordovia), founder of Forest-Oil OOO and General Director of Direction OOO*”.

⁹²⁶ Resp. C-Mem. on the Merits (**Exhibit RF-03.1.B-3**), § 254. Moscow Arbitrazh Court 29 June 2004 (C-121), p. 9 “*A.V. Zakharov – Head of Bark OOO (founder of Grace OOO) (Trehgorny) and Saturn XXV OOO (Republic of Mordovia), founder of Vokit OOO (vol. 299, p. 95). (...) Leonid Vasiliyevich Koval acts as one of the founders of Trigor ZAO (Minutes of the Meeting of Founders of Trigor ZAO No. 1 of 05.02.1997). He also founded Special Project OOO (vol. 349, pp. 166-169), which is the founder of 5 entities registered in the territory of Lesnoy Closed Administrative-Territorial Formation of Sverdlovsk Region: Staf OOO (vol. 127, pp. 76-89), Forest-Oil OOO . . . , Vald-Oil OOO . . . , Business-Oil OOO . . . , Mitra OOO . . . Alan OOO – the founder of Muskron OOO (Trehgorny) . . . acts as another shareholder of Mitra OOO.*”

⁹²⁷ See Resp. C-Mem. on the Merits (**Exhibit RF-03.1.B-3**) §§ 83-86; see also PWC Email dated 17 June 2004 (RME-2096); PWC Email dated 24 June 2004 (RME-2097); PWC Email dated 14 July 2004 (RME-2098).

receive additional income. I did not know that I was the head of OOO Makro-Trade and never occupied a managerial position."⁹²⁸

583. Notably, each of these regions of the Russian Federation—Mordovia, Evenkia, Kalmykia, Trekhgornyi, and Lesnoy—had been subjected to a low-tax regime specifically to encourage business activity in economically depressed areas of the Russian Federation. By selling oil by means of paper transactions at below-market prices to shell companies in these low-tax jurisdictions, nothing was done to advance genuine business activities in those regions.⁹²⁹ The scheme had no other purpose than to pay extremely low rates of tax on sales of oil produced in Nefteyugansk, Samara, and Tomsk.⁹³⁰
584. The detailed decisions of the tax authorities and subsequently issued rulings of the Russian tax courts offer numerous examples showing how oil was sold from one sham company to the other.⁹³¹ For example, in a ruling of 16 August 2005 of the Moskow High Court, a relatively simple example was discussed.⁹³² It concerned three transactions in which Mr.

⁹²⁸ See Resp. C-Mem. on the Merits (**Exhibit RF-03.1.B-3**) § 242. A detailed account of the testimony of these strawmen that follows from the record is provided in Annex 1 to this Defence on Appeal (see RME-256, RME-257, RME-259).

⁹²⁹ See Anilionis Declaration (**Exhibit RF-200**), §§ 34-37; Zakharov Declaration. (**Exhibit RF-201**), §§ 16-17.

⁹³⁰ In the Russian tax proceedings Yukos failed to provide any sensible explanation for such transactions other than tax evasion. See e.g. (RME-252) p. 7: *"During the hearing the representatives of OAO NK YUKOS, following the court's request to justify the economic effectiveness of selling oil under the above scheme in relation to OAO NK YUKOS, the actual owner of the oil producing companies, failed to provide any reasonable explanations and simply referred to the common practice of engaging intermediaries in transactions (see the transcript of court hearing dated November 16-17, 2004). However, such transactions had a real purpose - reduction of tax obligations of OAO NK YUKOS by means of recording the bulk of the income as received by companies registered in regions with beneficial tax treatment."* Also see Anilionis Declaration, §§ 34-37; Zakharov Declaration (**Exhibit RF-201**), §§ 16-17.

⁹³¹ See e.g. Resp. C-Mem. on the Merits (**Exhibit RF-03.1.B-3**), § 245, chart 6 for another example.

⁹³² The Ninth Arbitrazh Appellate Court, 16 augustus 2005, (RME 251), p. 28. *"Mr. M.V. Elfimov as a representative of OAO Tomskneft VNK entered into oil sale purchase agreement No.02/6-n dated January 20, 2003 (volume 1552, pages 41-44) with a price of oil being RUR 1,350 per tonne, the oil metering station of OAO Tomskneft VNK. The act of delivery and acceptance No.111 dated February 15, 2003 and No.1/2 dated February 28, 2003 (volume 1552, pages 46 and 47). The oil from the resource of OOO Tomskneft VNK was "sold" by OOO Evoil to OOO Fargoil under sale and purchase agreement No.02/08-00ne dated August 19, 2002 (volume 1548, pages 11-14), Addendum No.9 dated January 23, 2003 (volume 1548, page 39). The price of oil was RUR 1,352 per tonne. The act of delivery and acceptance No.9 dated February 28, 2003 (volume 1548, page 40), the oil metering station of OAO Tomskneft VNK. In its turn, OAO NK YUKOS sent the oil "acquired" by OOO Fargoil for export under contract No.643/00044440IYuKiUnipeç-0 Ijl dated August 30, 2001 entered into by Mr. M.V. Elfimov with China International United Petroleum (China) (volume 1686, pages 108-120). According to cargo customs declaration No.100060011280403/0001225 the person who was responsible for financing of this*

UNOFFICIAL TRANSLATION

This text is an unofficial translation of the Dutch original. In case of any discrepancies, the Dutch original shall prevail.

Elfimov (of Yukos Oil Company) played a crucial part. The transactions and corresponding prices are detailed below.

- (a) Transaction 1: Mr. M.V. Elfimov, formally as representative of the production company Tomskneft, sold the oil Tomskneft had produced and stored locally for RUR 1,350 per ton to the company Evoil.
- (b) Transaction 2: Evoil was a company located in the region of Evenkia. The company was in fact secretly controlled by Yukos Oil through an obscure network of offshore companies.⁹³³ Evoil sold the same oil to Fargoil for RUR 1,352 per ton.
- (c) Transaction 3: Fargoil was located in the Mordovia region. Fargoil was also secretly managed and controlled by Yukos Oil.⁹³⁴ In this specific transaction, Mr. M.V. Elfimov sold the oil on behalf of Fargoil to a Chinese buyer. This time, he sold the oil for five times as much as it had been sold previously: RUR 6,521 per ton.

transaction was OAO NK YUKOS (volume 1686, page 96) with invoices indicating the price of oil in the amount of USD238 per tonne (volume 1686, pages 97-107) which at the date of the payment amounted to RUR 6,521 per tonne. Thus, by executing the documents for re-selling of oil through a number of companies Senior Vice-President of OAO NK YUKOS, Mr. M.V. Elfimov, sold the same oil with an increase of RUR 5, 171 per tonne or 4,8 times more expensive."

⁹³³ Formally, the shares of Evoil were (indirectly) held by offshore companies such as Fiana and Zowgate. To third parties it was unknown that these companies were in fact controlled by Yukos itself.

⁹³⁴ The shares of Fargoil were held by the Cypriot company Nassaubridge. The shares in Nassaubridge were (indirectly) held by companies on the BVI. Ultimately, the so-called Stephen Trust had a 90% interest in Fargoil. The Stephen Trust was controlled by Yukos Oil through call options.

UNOFFICIAL TRANSLATION

This text is an unofficial translation of the Dutch original. In case of any discrepancies, the Dutch original shall prevail.

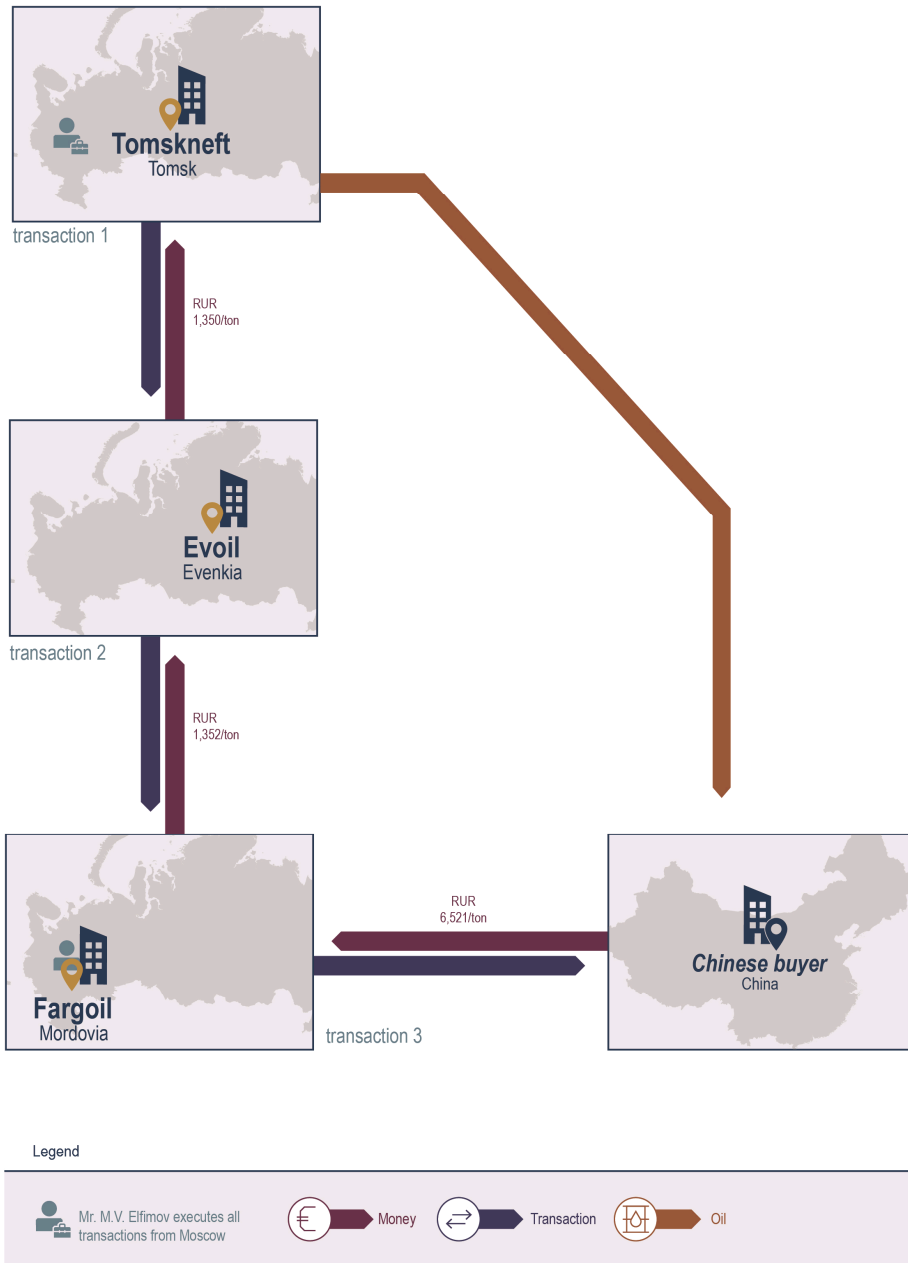

585. The oil contracts in question were not negotiated and concluded by employees in Evenkia, Mordovia or Tomsk.⁹³⁵ The transactions were drafted and signed in an office building of

⁹³⁵ In this respect, another example in which Mr. Elfimov was involved comes to mind. As explained in a court ruling of 18 November, 2004, Mr. Elfimov would have taken part in auctions in Samara, Tomsk

Yukos Oil in Moskow.⁹³⁶ There was no business purpose for the many transactions. Obviously, the oil was not in fact dragged back and forth thousands of kilometers. The oil remained in the Tomsk region until it was finally delivered to the Chinese buyer. The purpose of these transactions was that profits would be shifted to low tax regions such as Mordovia.

586. In Russian Court decisions many other examples are given in which oil was sold at increased prices. Most of those transactions were somewhat more complex. For example, a decision of an Appellate Court of 5 March 2005 concerned the sale of oil in a chain of five different transactions. The price of the final transaction was ultimately 6 times higher than that of the first transaction.⁹³⁷

and the Khanti-Mansi region all on 22 January, 2001. Coincidentally, oil was sold at these auctions for the exact same price by Tomskneft, Yuganskneftegaz and Samaraneftgaz. See RME 254, p. 15: "*The aforementioned conclusion is confirmed by the "sale" of oil for export by OOO Yu-Mordovia under a commission agency agreement with OAO NK YUKOS. OOO Yu-Mordovia purchased oil in February 2001:*

from OAO Samaraneftgaz (agreement No. SM-01/02 dated January 22, 2001 - vol. 174 case sheet: 22) represented by M.V. Elfimov, at a price of 1,001 roubles per ton (delivery and acceptance certificate No. 2/21 dated February 28, 2001 - vol. 174 case sheet: 28);

from OAO Tomskneft VNK (agreement No. TM-03/02 dated January 22, 2001 - vol. 174 case sheet: 197) represented by M.V. Elfimov, at a price of 1,001 roubles per ton (summary delivery and acceptance certificate No. [illegible] dated February 28, 2001 - vol. 174 case sheet: 203);

from OAO Yuganskneftegaz (agreement No. YUM-02/02 dated January 22, 2001 - vol. 173 case sheet: 132) represented by M.V. Elfimov, at a price of 1,001 roubles per ton (delivery and acceptance certificate for February 2001 - vol. 173 case sheet: 138).

M.V. Elfimov concluded the first agreement on the basis of an auction in Samara, the second in the town of Strezhevoi, Tomsk Region, and the third - in Nefityugansk, a town in the Khanti-Mansi Autonomous District. All agreements were concluded on the same day, namely, January 22, 2001.

Further, OOO Yu-Mordovia "transfened" oil for export sale to OAO NK YUKOS, with whom a commission agency agreement was signed on December 31, 1999 under No. YU-9-4-01/1853 (vol. 178 case sheet: [illegible] 6). This agreement was concluded on behalf of the defendant by Senior Vice President M.V. Elfimov. In February 2001, M.V. Elfimov, on behalf of OAO NK YUKOS, sold oil that "belonged" to OOO Yu-Mordovia for export, under contract [illegible] 643/00044440/00146 dated May 10, 2000, concluded with Rutenhold Holdings Limited, Cyprus (vol. 178 case sheet: 43). In this case, oil (acquired for 1,001 roubles) was sold at a price of [illegible] US Dollars per ton, which is the equivalent of 4,935 roubles per ton at the exchange rate as at the date of payment (vol. 178 case sheet: 127), almost five times more expensive."

⁹³⁶ See also RME-251, p. 35, in which an example is given of Mr. Belyaevskiv being in Nefteyugansk (in the KhantyMansy region), in Strezhevoy (in the Tomsk region) and in Samara (in the Samara region) on the same day, 16 September 2003, to conclude contracts. See also RME-252, p. 7, detailing another example of Mr. Elfimov having joined "tenders" in different parts of the Russian Federation.

⁹³⁷ Ninth Arbitrazh Appellate Court dated 5 March 2005, RME-253, p. 19. "*For example, OAO Samaraneftgaz sold oil to OOO Ratibor pursuant to agreement dated February 18, 2002 No. 037-n (volume 134 pages 138-141). The sale and purchase agreement was executed by Elfimov M.V., on behalf of OAO Samaraneftgaz and acting under the power of attorney issued by OOO YUKOS EP and the agreement*

587. The sham companies and sham transactions were obviously aimed at avoiding local profit tax. In most instances, the scheme was nevertheless expanded beyond the borders of the Russian Federation. Most of the oil that was allegedly exported was sold to foreign offshore companies such as Behles Petroleum S.A. or Routhenhold Holdings Limited. These foreign sham companies were however secretly controlled by the Russian Oligarchs. Even Yukos' own auditor PwC claimed it did not know that certain of those entities were related to Yukos Oil. PwC claimed it had been deceived by the Russian Oligarchs.⁹³⁸

(c)(iii) *The Russian Oligarchs' Concealment of the Tax Fraud*

588. Obviously, the Russian Oligarchs were well aware of the illegality of their tax schemes. They had been warned several times by external and internal advisors. Mr. Gololobov declared:

"[B]oth the in-house legal consultants at Yukos and retained counsel had always advised the Oligarchs that legitimate tax-optimization strategies 'must have a real economic purpose and must be carried out within the framework of

on the transfer of powers of the executive bodies dated September 29, 1998; the oil price under the agreement was RUR 670 per ton (acts of transfer and acceptance No.6, No.7 for March 2002 - volume 134 pages 148, 146); the oil metering station belonged to OAO Samaraneftgaz.

Next, pursuant to agreement No. 018-n dated December 20, 2001 (volume 128 page 19), OOO Ratibor "sold" oil out of the stock of OAO Samaraneftgaz to OOO Fargoyl at the price of RUR755 per ton at the oil metering station of OAO Samaraneftgaz (supplement No. 43 dated February 20, 2002 - volume 128 page 89, act of transfer and acceptance No. 43 dated March 31, 2002 - volume 123 page 87).

Next, OOO Fargoyl entered into agreement No. 01/05-0001 dated May 28, 2001 (volume 152, pages 183-186) with ZAO YUKOS-M to sell oil at the price ofRUR 1,551 per ton (supplement No.2 dated February 21, 2002 - volume 152 page 191, act of transfer and acceptance No.2 dated March 31, 2002 - volume 152 page 192).

Subsequently, ZAO YUKOS-M "sold" oil out of the stock of OAO Samaraneftgaz for export to Routhenhold Holdings Limited (Cyprus). At the same time, OOO YUKOS-M entered into commission agreement No. YuO-4-01/67 dated January 31, 2000 with OAO NK YUKOS, represented by Elfimov M.V., its Senior Vice President, (volume 152 pages 5-9), pursuant to which OAO NK YUKOS undertook to sell oil on the foreign market. OAO NK YUKOS was listed as the shipper in cargo customs declaration No. 103091401060402/0000066 (volume 152 page 92), invoice No. RTH-0542-c (volume 152 page 86); contract No. 643/00044440100207 dated September 21, 2001 (volume 152 pages 93-99) was executed by Elfimov M.V. on behalf of OAO NK YUKOS; the sale price of oil was listed as US \$139.43, which convells to RUR 4,343.24 at the exchange rate effective as of the date of payment.

Thus, while all of the oil sales documents were being executed between the various dependent companies, the oil remained at the oil metering stations of OAO Samaraneftgaz and was not shipped to the new "owners". As a result of such operations, the price of oil increased by RUR 3,673.24 or 6.4 times, solely by means of reselling the oil between the dependent companies." It must be noted that the final buyer Routhenhold Holdings was in fact controlled by the Russian Oligarchs. It must be assumed that this company sold on the oil for an even higher price.

⁹³⁸ See Final Awards, marginal nos. 1226-1230, 1247 in which even the Tribunal had to concede "that PwC's contentions in this regard may have been true" and that "Yukos may not have been candid".

normal business activities, and must not be artificially 'crafted' for the optimization of taxes.' The Oligarchs' offshore and onshore tax-optimization schemes usually lacked any economic substance whatsoever, which created obvious legal risks, and Mr. Khodorkovsky had been advised accordingly."⁹³⁹

589. The Russian Oligarchs deliberately concealed that the sham companies in the low tax regions were in fact controlled by Yukos Oil. For example, when Yukos Oil Company considered a New York Stock Exchange listing in 2002, the company was required to provide information on its subsidiaries. An internal memo that was sent to Khodorkovsky in 2002 warned that doing so would reveal that the shell companies in e.g. Mordovia were in fact controlled by Yukos. The memo warned that such could result in significant tax claims against Yukos as well as personal liability claims against the officers of the company:

"As far as we understand, the Company has created a complex structure of subsidiaries in a number of jurisdictions primarily with a view to maximising tax efficiency. This system enables the Company to capitalise on the disconnected legal regimes and treat certain legal entities differently for the purposes of the legal and tax regimes in Russia and, say, the US accounting standards. There is a risk (and we are currently trying to establish its magnitude) that the materials submitted to the SEC and made available to the public must contain the names of such entities and indicate their affiliation with the Company. The Russian tax authorities could use such information to contest our approach to a number of deals and hence result in significant tax claims against the Company. In the worst-case scenario this may result in attempts to impose administrative and tax liability upon officers of the Company. (...)"⁹⁴⁰

590. Attempting to avoid the imposition of "significant tax claims against the Company,"⁹⁴¹ the Russian Oligarchs' efforts at concealing their evasion of corporate profit tax took several different forms.
591. First, the Russian Oligarchs consistently made false representations to regulators, minority investors, and the public regarding the nature of these transactions with their subsidiaries. For example, Yukos made the following commitment in its highly-publicized Corporate

⁹³⁹ Golobolov Declaration (**Exhibit RF-G2**), § 74.

⁹⁴⁰ See Golobolov Declaration (**Exhibit RF-G2**, Annex R-664). The very same message is contained in many similar memoranda that were exchanged in the same time period. See RME-3245, p. 2 and RME-184.

⁹⁴¹ See Golobolov Declaration (**Exhibit RF-G2**, Annex R-664). The very same message is contained in many similar memoranda that were exchanged in the same time period. See RME-3245, p. 2 and RME-184.

Governance Charter on 3 June 2000: “*Transactions with friendly parties, if any, will be on an arm’s length basis and reported when applicable.*”⁹⁴² As a second example, the 2000 Annual Report claimed that Yukos carried out “*arm’s-length transactions with all related parties.*”⁹⁴³ As by the ECtHR, all of these statements about “arm’s-length transactions” were false.⁹⁴⁴

592. Second, the Russian Oligarchs also caused the sham companies to file false VAT tax returns. Most of the oil that was supposedly exported was sold from one sham company to another sham company by means of a sham transaction. The companies that purportedly exported oil thus filed false VAT tax returns, based on these fictitious transactions (also see §§ IV.D(g) VI.E(d)) on legal issues relating to VAT). Although, the oil was actually sold by Yukos, Yukos itself failed to file VAT returns. Logically, if Yukos had itself claimed VAT exemptions with respect to the export transactions, this would have alerted the taxing authorities to the fact that Yukos was the real seller. The authorities would then have concluded that the sales to end users would be subject to the higher rate of corporate profit tax applicable to Yukos.

(c)(iv) *The European Court of Human Rights’ Condemnation of the Tax Fraud*

593. The Russian Oligarchs’ public pronouncements about their “arm’s length”⁹⁴⁵ transactions have now been proven false repeatedly in many rounds of litigation before different courts in different jurisdictions including the Netherlands.
594. Most notably, in 2011, a chamber of the ECtHR concluded unanimously in *OAO NK Yukos v. Russia* that Yukos Oil indeed committed a tax evasion on a massive scale:

“590. The Court has little doubt that the factual conclusions of the domestic Courts in the Tax Assessment Proceedings 2000-2003 (...) were sound.(...)”

591. (...) [T]he company’s “tax optimisation techniques” applied with slight variations throughout 2000-2003 consisted of switching the tax burden from the applicant company and its production and service units to letter-box companies in domestic tax havens in Russia. These companies, with no assets,

⁹⁴² See YUKOS Charter on Good Corporate Governance dated 3 June 2000 (C-37).

⁹⁴³ Yukos Annual Report 2000 (C-24), p. 29.

⁹⁴⁴ First ECtHR Ruling (RME-3328).

⁹⁴⁵ Yukos Annual Report 2000 (C-24), p. 29.

employees or operations of their own, were nominally owned and managed by third parties, although in reality they were set up and run by the applicant company itself. In essence, the applicant company's oil-producing subsidiaries sold the extracted oil to the letter-box companies at a fraction of the market price. The letter-box companies, acting in cascade, then sold the oil either abroad, this time at market price or to the applicant company's refineries and subsequently re-bought it at a reduced price and re-sold it at the market price. Thus, the letter-box companies accumulated most of the applicant company's profits. Since they were registered in domestic low-tax areas, they enabled the applicant company to pay substantially lower taxes in respect of these profits. Subsequently, the letter-box companies transferred the accumulated profits unilaterally to the applicant company as gifts. The Court observes that substantial tax reductions were only possible through the mixed use and simultaneous application of at least two different techniques. The applicant company used the method of transfer pricing, which consisted of selling the goods from its production division to its marketing companies at intentionally lowered prices and the use of sham entities registered in the domestic regions with low taxation levels and nominally owned and run by third persons (see paragraphs 14-18, 48, 62-63 for a more detailed description).

592. The domestic courts found that such an arrangement was at face value clearly unlawful domestically, as it involved the fraudulent registration of trading entities by the applicant company in the name of third persons and its corresponding failure to declare to the tax authorities its true relation to these companies (see paragraphs 311, 349-353, 374-380). This being so, the Court cannot accept the applicant company's argument that the letter-box entities had been entitled to the tax exemptions in questions. For the same reason, the Court dismisses the applicant company's argument that all the constituent members of the Yukos group had made regular tax declarations and had applied regularly for tax refunds and that the authorities were thus aware of the functioning of the arrangement. The tax authorities may have had access to scattered pieces of information about the functioning of separate parts of the arrangement, located across the country, but, given the scale and fraudulent character of the arrangement, they certainly could not have been aware of the arrangement in its entirety on the sole basis on the tax declarations and requests for tax refunds made by the trading companies, the applicant company and its subsidiaries.

593. The arrangement was obviously aimed at evading the general requirements of the Tax Code, which expected taxpayers to trade at market prices (see paragraphs 395-399), and by its nature involved certain operations, such as unilateral gifts between the trading companies and the applicant company through its subsidiaries, which were incompatible with the rules governing the relations between independent legal entities (see paragraph 376)."⁹⁴⁶ (emphasis added)

⁹⁴⁶ First ECtHR Ruling (RME-3328).

595. The ECtHR ruling on the tax fraud and the resulting tax reassessments is very extensive. The ECtHR e.g. explicitly confirmed the legality of the Russian Federation's VAT tax claims:

“601. . . . In view of the above, the Court finds that the relevant rules made the procedure for VAT refunds sufficiently clear and accessible for the applicant company to able to comply with it.

602. Having examined the case file materials and the parties' submissions, including the company's allegation made at the hearing on 4 March 2010 that it had filed the VAT exemption forms for each of the years 2000 to 2003 on 31 August 2004, the Court finds that the applicant company failed to submit any proof that it had made a properly substantiated filing in accordance with the established procedure, and not simply raised it as one of the arguments in the Tax Assessment proceedings, and that it had then contested any refusal by the tax authorities before the competent domestic courts (see paragraphs 49 and 171, 196, 196 and 216). The Court concludes that the applicant company did not receive any adverse treatment in this respect.”⁹⁴⁷

596. In 2013, a second chamber of the ECtHR unanimously reached the same conclusion in the parallel case of *Khodorkovskiy and Lebedev v. Russia*.⁹⁴⁸ In this judgment, the ECtHR also concluded that the Russian Oligarchs' scheme violated Russian tax law, which required that all “*contractual arrangements made by the parties in commercial transactions were only valid in so far as the parties were acting in good faith.*”⁹⁴⁹ The Russian Oligarchs' tax-optimization scheme, by contrast, “*was obviously aimed at evading the general requirements of the Tax Code, which expected taxpayers to trade at market prices (...), and by its nature involved certain operations (...) which were incompatible with the rules governing the relations between independent legal entities.*”⁹⁵⁰

597. Most recently, in a ruling dated 9 May 2017, the Amsterdam Court of Appeal rejected “[t]he assertion of [Yukos Managers] that there has been no tax evasion in respect of the profit tax, because Yukos Oil was permitted to make use of the options offered by favourable tax rules in force in certain regions (Mordovia in particular).”⁹⁵¹ To the contrary, the Amsterdam Court of Appeal adopted the ECtHR's reasoning that, indeed,

⁹⁴⁷ First ECtHR Ruling (RME-3328).

⁹⁴⁸ Second ECtHR Ruling (**Exhibit RF-4**).

⁹⁴⁹ Second ECtHR Ruling (**Exhibit RF-4**).

⁹⁵⁰ Second ECtHR Ruling (**Exhibit RF-4**).

⁹⁵¹ Court of Appeal of Amsterdam 9 May 2017, ECLI:NL:GHAMS:2017:1695, §§ 4.25-4.27.

*“there was large-scale and lengthy tax evasion regarding the profit tax using legal entities that had no real activities (the sham entities, hereinafter also referred to as ‘sham companies’), which entities merely served to facilitate and disguise Yukos Oil’s actions.”*⁹⁵²

598. Various courts and tribunals have reviewed the abundant evidence and have on such grounds come to the same conclusion. The Tribunal uniquely reached the following – deviating – conclusion: *“The Tribunal has not found any evidence in the massive record that would support Respondent’s submission that there was a basis for the Russian authorities to conclude that the entities in Mordovia, for example, were ‘shams’.”*⁹⁵³ As further detailed below in chapter VI.D, this is an unreasoned and clearly erroneous conclusion, reflecting a manifest failure to consider and to analyze.
599. The tax evasion schemes of Yukos set up by the Russian Oligarchs were the most blatant and massive ever seen in the history of the Russian Federation. The fraud committed by Yukos led to appropriate government actions, including tax reassessments. Those reassessments were legitimate, as was confirmed by the European Court of Human Rights.

(c)(v) Conclusion

600. The Russian Oligarchs devised an illegal scheme of sham companies and sham transactions to commit a multibillion-dollar tax fraud within the Russian Federation’s domestic low-tax jurisdictions.
601. This factual conclusion is of significance for a number of annulment grounds in these appellate proceedings:
- (a) Jurisdiction Ground 3: The Tribunal lacked jurisdiction to decide this dispute precisely because this case concerns Taxation Measures (Article 21(1) ECT, see chapter IV.D below).
 - (b) Mandate Ground 1: The Tribunal was required to refer the case to the competent tax authorities pursuant to Article 21(5) ECT, but

⁹⁵² Court of Appeal of Amsterdam 9 May 2017, ECLI:NL:GHAMS:2017:1695, §§ 4.25-4.27.

⁹⁵³ Final Awards, marginal no. 639.

wrongly failed to do so. As a result, the Tribunal's ruling on taxation contains serious mistakes (chapter V.C below).

- (c) Reasoning Ground 2: The Tribunal ignored the voluminous evidence on the Mordovian sham companies (chapter VI.D below).
- (d) Public Policy Grounds 2, 3 and 6: The Tribunal did not base its decision on the facts but on unfounded speculation that the Russian Federation would have imposed taxes "*no matter what Yukos did*". Furthermore, the Tribunal did not consider Russian laws, but rather supplanted the law with its own views on what the law should be (chapters VII.D, VII.E and VII.H below).
- (d) ***Phase 4 - The Russian Oligarchs Obstructed Tax Enforcement, While Simultaneously Stripping Billions of Dollars from Yukos Through HVY***

(d)(i) *Introduction*

602. Finally, the Russian Oligarchs took numerous measures to obstruct the Russian Federation's enforcement of its tax laws.⁹⁵⁴ Simultaneously, the Russian Oligarchs stripped billions of U.S. dollars from Yukos and concealed these funds offshore, rather than using this money to enable Yukos to pay outstanding debts.⁹⁵⁵

(d)(ii) *The obstruction of justice and the destruction of evidence*

603. The specifics of the Russian Oligarchs' bad-faith obstruction were addressed in detail in the Russian Federation's pleadings during the Arbitrations.⁹⁵⁶ An important element was that Russian Oligarchs obstructed the authorities' attempts to gather evidence.⁹⁵⁷ They used their political influence to terminate or suspend investigations, instructed witnesses to provide false testimonies and bluntly refused to release documents to the tax authorities.⁹⁵⁸

⁹⁵⁴ Final Awards, marginal no. 1309; *see also* Resp. Rej. on the Merits (**Exhibit RF-03.1.B-5**), § 1435.

⁹⁵⁵ Final Awards, marginal no. 1309; *see also* Resp. Rej. on the Merits (**Exhibit RF-03.1.B-5**), § 1435.

⁹⁵⁶ RF Post-Hearing Brief, §§ 2-5; Resp. Rej. on the Merits (**Exhibit RF-03.1.B-5**), § 31 et seq.; Resp. C-Mem. on the Merits (**Exhibit RF-03.1.B-3**), §§ 13 et seq.

⁹⁵⁷ Resp. C-Mem. on the Merits (**Exhibit RF-03.1.B-3**), §§ 674 et. seq.

⁹⁵⁸ RF Post-Hearing Brief, §§ 29 et seq.; Resp. Rej. on the Merits (**Exhibit RF-03.1.B-5**), § 32, 55; Resp. C-Mem. on the Merits (**Exhibit RF-03.1.B-3**), §§ 355 et seq. and 674 et. seq.

604. The Russian Oligarchs have consistently destroyed evidence to conceal illegalities. For example, in 1999 the Russian Oligarchs had ordered a driver to drive a truck containing 670 boxes of Bank Menatep's documents into the Volga to conceal bankruptcy fraud.⁹⁵⁹
605. Whilst publicly denying tax fraud, the Russian Oligarchs ordered the destruction of significant amounts of documentary evidence relating to the fraud.⁹⁶⁰ During the Arbitrations⁹⁶¹ the Russian Federation showed that documents had been destroyed, as was recently confirmed by Mr. Gololobov:

"75. Of the numerous legal opinions that Mr. Aleksanyan and I produced over the years, very few remain. This is because, shortly after Mr. Khodorkovsky was arrested in October 2003, we were ordered by the Oligarchs to shred our legal opinions, as well as countless other documents. This shredding process lasted for several weeks, and involved many Yukos employees. The documents destroyed were those held by the legal department, and by other departments that we had advised. The electronic system was also cleaned, including removing and replacing all hard drives. A policy was then put in place requiring periodic destruction of numerous categories of documents, including our legal opinions. No such policy had existed prior to 2003."⁹⁶²

606. Later, when the Russian Federation wished to enforce the tax decisions the Russian Oligarchs sabotaged these attempts by all possible means. For example, when the Russian Federation tried to auction Yukos' shares in Yuganskneftgaz, the Russian Oligarchs did everything to avoid interested bidders participating.⁹⁶³ The auction of Yuganskneftgaz will be discussed in §§ 1158-1171.

⁹⁵⁹ Gololobov Declaration (**Exhibit RF-WG2**), §§ 36-38.

⁹⁶⁰ 2012 RF Post-Hearing Brief, § 38; Resp. Rej. on the Merits (**Exhibit RF-03.1.B-5**), § 55; Resp. C-Mem. on the Merits (**Exhibit RF-03.1.B-3**), § 681.

⁹⁶¹ The Tribunal acknowledged in the Final Awards that e-mails were sent to destroy all references to sham companies in Lesnoy and Trekghorny. "405. *The Tribunal notes that, in March 2002, Mr. Dmitry Maruev, Yukos' Deputy Financial Manager, e-mailed M. U. Barbarovich and V. M. Zhuravlev and asked that they clean their e-mail folders and servers of references to a number of companies, some of which ("Alebra, Greis, Business Oil, Vald Oil, Kverkys [sic], Kolrein, Mitra, Muskorn, Nortex") had been merged into Investproekt.*"

⁹⁶² Gololobov Declaration (**Exhibit RF-WG2**), § 75.

⁹⁶³ See in this regard Writ, §§ 570 and 573 and SoR, §§ 732, 776 and 824.

(d)(iii) *The Russian Oligarchs siphoned at least USD 6 billion from the Russian Federation to offshore bank accounts; they are still enjoying the fruits of their crimes*

607. The Russian Oligarchs were well aware of their own illegal conduct (see §§ 588-589 above). In 2003, shortly after Mr. Khodorkovsky and Mr. Lebedev were arrested for tax evasion, the Russian Oligarchs knew that the Russian tax authorities would impose tax claims on Yukos Oil Company. The Russian Oligarchs could at that point have saved the available cash to pay these claims, but instead let Yukos pay dividends worth approximately USD 2 billion and spend a further USD 2 billion in share buybacks.⁹⁶⁴ HVY – the appellants in these proceedings – were directly involved in this phase of the scheme.⁹⁶⁵ Even the Tribunal had to agree that HVY "*might have more prudently acted to conserve Yukos' resources rather than to proceed with a massive dividend.*"⁹⁶⁶
608. Subsequently, in 2005, the Russian Oligarchs and their agents secured assets of Yukos subsidiaries based in tax havens. Offshore companies, that were mostly based in the British Virgin Islands, had accumulated huge amounts of money. It concerned the profits from Yukos' tax evasion scheme described above (see §§ 569-574 and 580-586 above). To ensure that they could continue to enjoy the fruits of their crimes, the Russian Oligarchs restructured the corporate structure of Yukos once again. This time, two Dutch *Stichtings* were set up that would control foreign assets of more than USD 2 billion. The *Stichtings* had no other purpose than to prevent the Russian authorities from collecting the taxes they were entitled to. Over the years, a significant part of those assets have been disbursed to HVY.⁹⁶⁷
609. The aforementioned assets stripped from Yukos between 2003 and 2005 have a combined value of at least USD 6 billion. This allowed the Russian Oligarchs to build a business

⁹⁶⁴ Resp. Rej. on the Merits (**Exhibit RF-03.1.B-5**), §§ 130; Resp. C-Mem. on the Merits (**Exhibit RF-03.1.B-3**), § 350; Hulley Annual Report dated 31 December 2003 (**Exhibit RF-358**); VPL Annual Report dated 31 December 2003 (**Exhibit RF-359**); YUL Annual Report dated 31 December 2003 (**Exhibit RF-360**).

⁹⁶⁵ See Hulley Annual Report dated 31 December 2003 (**Exhibit RF-358**); VPL Annual Report dated 31 December 2003 (**Exhibit RF-359**); YUL Annual Report dated 31 December 2003 (**Exhibit RF-360**). See e.g. Resp. C-Mem. on the Merits (**Exhibit RF-03.1.B-3**), § 349 et. seq. on the payment of the largest dividend payment.

⁹⁶⁶ Final Awards, marginal no. 869.

⁹⁶⁷ Respondent's Post-Hearing Brief, §§ 120 et seq.; Resp. Rej. on the Merits (**Exhibit RF-03.1.B-5**), §§ 1076 et seq.; Resp. C-Mem. on the Merits (**Exhibit RF-03.1.B-3**), §§ 528 et seq.

UNOFFICIAL TRANSLATION

This text is an unofficial translation of the Dutch original. In case of any discrepancies, the Dutch original shall prevail.

empire in North America and Europe. In April 2015, the Russian Oligarchs' concealed assets were discovered by *Forbes*, and publicized in an online article.⁹⁶⁸

610. The Russian Oligarchs have evidently created to two other corporate structures, known as Quadrum Global and Cube Capital,⁹⁶⁹ to hold their assets. The assets that are constantly being laundered by these structures are managed by Mr. Oleg Pavlov, Mr. Francois Buclez, and Mr. Alan Sipols. All three of them had previously worked for the Oligarchs as the directors of Group Menatep Investments ("GMI"), a subsidiary of GML responsible for making investments on behalf of the Russian Oligarchs.⁹⁷⁰ Mr. Buclez was also a member of the board of directors for Yukos,⁹⁷¹ and Mr. Pavlov was a principal financial advisor to the Oligarchs.⁹⁷²
611. The discoveries by *Forbes* are based on a document that was made public in Miami Beach, Florida. It concerned a mandatory registration form filed by a lobbyist that had been involved in lobby activities on behalf of Quadrum Global. The registration form revealed that Quadrum Global continues to be wholly owned and controlled by a group of Guernsey trustees on behalf of the Oligarchs.⁹⁷³ Upon discovering this information, *Forbes* published another online article observing that, apparently, the Russian Oligarchs are once again among the 200 wealthiest Russian nationals in the world.⁹⁷⁴
612. Shortly after the *Forbes* article was published, the Russian Oligarchs' representative, Mr. Oleg Pavlov, made public and unconditional denials as to any connection between the

⁹⁶⁸ Anton Wierzbicki and Peter Rudenko, 'The oil was distilled in real estate', *Forbes* 1 April 2015, (**Exhibit RF-307**).

⁹⁶⁹ See Press Release Cube Capital dated 13 December 2013, - 'Cube to Focus on Core Hedge Fund Business' (**Exhibit RF-308**).

⁹⁷⁰ GMI Annual Report 2003 (C-1230).

⁹⁷¹ Yukos Board Minutes No. 120/1-24 dated 28 October 2003 (RME-3605) and Yukos Board Minutes No. 120-18 dated 19 August 2004 (Annex (Merits) C-210).

⁹⁷² See Resp. Rej. on the Merits (**Exhibit RF-03.1.B-5**), § 816; Expert Opinion Prof. Pieth January 2017 (**Exhibit RF-D13**, Annex MP-69).

⁹⁷³ A. Wierzbicki and P. Rudenko, 'The Oil was Distilled in Real Estate', *Forbes* 1 April 2015 (**Exhibit RF-307**).

⁹⁷⁴ Forbes Russia, 'Russia's 200 Wealthiest Businessmen 2016', *Forbes.ru* 14 April 2016 (**Exhibit RF-309**).

UNOFFICIAL TRANSLATION

This text is an unofficial translation of the Dutch original. In case of any discrepancies, the Dutch original shall prevail.

Russian Oligarchs and Quadrum Global.⁹⁷⁵ The Russian Oligarchs also took other steps to conceal their connections to Quadrum Global, especially to quickly replace the specific registration form with a new form. Five days after the *Forbes* article was published in 2015, the Russian Oligarchs' lobbyist had replaced the old registration form with a new one, deleting the names of the Russian Oligarchs.⁹⁷⁶ By the end of 2015, the Miami registration form had been replaced a second time. This time, the Miami registration form stated nothing more than: “[N]o one holds 5% or more ownership.”⁹⁷⁷

613. Despite these denials, the Russian Oligarchs of GML still own and control Quadrum Global. In June 2016, a court filing by Quadrum Global in the U.S. District Court for the Eastern District of New York confirmed that the ultimate ownership of Quadrum Global rests with as “*a number of Trusts, all organized under the laws of Guernsey with beneficiaries who reside and are domiciled in Israel and the United Kingdom.*”⁹⁷⁸ Significantly, Mr. Brudno, Mr. Dubov, and Mr. Nevzlin all live in Israel, and Mr. Khodorkovsky now resides in the United Kingdom. Property records registered in New York also confirm that the owners of Quadrum Global are indeed a group of trusts managed by Saffery Champness: the same trustee in Guernsey that looks after GML on behalf of the Russian Oligarchs.⁹⁷⁹
614. The Oligarchs' known real-estate assets are listed on the Quadrum Global website, and are described as being worth USD 2 billion.⁹⁸⁰ Meanwhile, Cube Capital has filed registration forms reporting assets worth USD 920 million.⁹⁸¹ It is unknown where the remainder of the Russian Oligarchs' wealth is maintained.

⁹⁷⁵ Gil Tanenbaum, 'Quadrum Global Denies Mikhail Khodorkovsky Is One of Its Owners', *Jewish Business News* 22 April 2015 (**Exhibit RF-310**); Georgian Day, 'Investment Group Denies Khodorkovsky's Connection with Tbilisi Projects worth \$200 Million' available at: georgianday.com (**Exhibit RF-311**).

⁹⁷⁶ Revised City of Miami Beach Lobbyist Registration Form dated 6 April 2015 (**Exhibit RF-312**).

⁹⁷⁷ Second Revised City of Miami Beach Lobbyist Registration Form - N.O. Kasdin dated 23 December 2015 (**Exhibit RF-313**).

⁹⁷⁸ Bridgewater v Quadrum Joint Notice of Removal dated 2 June 2016 (**Exhibit RF-314**).

⁹⁷⁹ Compare NYC Office of the City Register, Filed Deed for 15 E 26th St Unit 20C 13 April 2010 (**Exhibit RF-315**), with Letter from K. Hudson to Shearman & Sterling LLP 19 December 2006 (**Exhibit RF-316**); see also Letter from the Claimants to the Arbitral Tribunal 3 November 2006 (**Exhibit RF-317**).

⁹⁸⁰ Portfolio - Quadrum Global dated 5 July 2017 (**Exhibit RF-318**); Press Release of Quadrum Global dated 4 August 2015 (**Exhibit RF-319**).

⁹⁸¹ Cube Capital LLP - SEC Registration Form ADV dated 26 March 2015 (**Exhibit RF-320**).

(d)(iv) Conclusion

615. The Russian Oligarchs consistently obstructed the process of fact-finding by withholding documents, destroying evidence and instructing witnesses to provide a false testimony. Subsequently, the Russian Oligarchs tried to thwart the process of tax collection. Two of the annulment grounds in these proceedings relate to the manner in which the auction of shares of OAO Yuganskneftegaz was frustrated. The Russian Oligarchs issued threats of litigation and commenced a spurious bankruptcy proceeding in the United States (see §§ 1158-1171 below).⁹⁸²
616. The most important means to frustrate the Russian Federation's attempts to collect taxes was the Russian Oligarchs' (and HVY's) siphoning of at least USD 6 billion of illegally obtained funds from Russia to offshore bank accounts. These funds have been and are still being laundered by means of corporate entities such as Quadrum Global and Cube Capital.

C. The Russian Oligarchs' Continuous Deception Regarding Their Ownership and Control of HVY

617. HVY bring forward a number of allegations about the Russian Oligarchs' ownership and control of HVY, and the question of whether the true relationship between HVY and the Russian Oligarchs was fully and correctly disclosed during the ECT arbitrations.
618. According to HVY, *"the allegation that Bank Menatep and the so-called 'Oligarchs' set out to conceal Yukos' control structure to prevent a reversal of Yukos' privatisation in response to alleged illegalities during the privatisation of Yukos has no basis in fact whatsoever."*⁹⁸³ HVY further assert that: *"Yukos' ownership structure was and has always been a matter of public knowledge,"*⁹⁸⁴. They further argue that *"in 2002, the ownership structure of Yukos was confirmed publicly by Yukos and its majority shareholder, GML."*⁹⁸⁵ In addition, HVY argue that *"HVY made full disclosure of their ownership structure and even submitted to the Arbitral Tribunal a schedule (...)"*⁹⁸⁶ Finally, HVY

⁹⁸² Writ § 533, SoR §§ 776, 823-824; see also RF Post-Hearing Brief § 127; Resp. Rej. on the Merits (**Exhibit RF-03.1.B-5**) § 198; Resp. C-Mem. on the Merits (**Exhibit RF-03.1.B-3**), § 351 and footnote 461.

⁹⁸³ SoA, § 826.

⁹⁸⁴ SoA, § 837.

⁹⁸⁵ SoA, § 837.

⁹⁸⁶ SoA, § 837.

maintain that the ECT arbitrators allegedly had all of the correct information necessary to conclude: “*VPL is owned and controlled by the trustee of the Veteran Petroleum Trust and that Hulley and YUL are owned and controlled by GML Ltd. and / or the trustees of the Guernsey trusts.*”⁹⁸⁷

619. In fact, HVY’s arguments confuse and distort the record with misrepresentations and half-truths – just as the Russian Oligarchs have always done with respect to their ownership and control of HVY and their Yukos shares. The truth is that the Russian Oligarchs’ have consistently made misrepresentations. The only way of truly understanding the Russian Oligarchs’ deception of the Russian people and the ECT arbitrators, therefore, is to set out their statements in a precise timeline, as reflected below.

(a) ***1996-2002 - The Russian Oligarchs Concealed Their Ownership of Yukos***

620. HVY suggest that it was “a matter of public knowledge” that the Russian Oligarchs had obtained Yukos during the ‘Loans-for-Shares’ auction in December 1995.⁹⁸⁸ In other words, HVY are essentially urging the inference that the Russian Oligarchs would have no need to misrepresent or deceptively conceal a fact that was publicly known.
621. This is also a misrepresentation. As noted by Professor Pieth, immediately after the Yukos privatization process began in December 1995, there were many rumors that the Russian Oligarchs had won the first part of the ‘Loans-for-Shares’ auction through collusive and corrupt manipulation.⁹⁸⁹ The Russian Oligarchs’ representatives, therefore, made false statements directly to the media in order to deny or conceal their involvement.⁹⁹⁰ Specifically, a Bank Menatep executive named Mr. Konstantin Kagalovsky misrepresented the truth in a statement to *Reuters*:

⁹⁸⁷ SoA, § 837.

⁹⁸⁸ SoA, § 836.

⁹⁸⁹ As noted by Professor Pieth, these rumors are reflected in many of the same newspaper accounts which HVY have cited. Expert Opinion Prof. Pieth October 2017 (**Exhibit RF-D14**), § 93. In December 1995, for example, the *Moscow Times* reported that “[t]he loans-for-shares program which started last month has been plagued by scandal ‘It is just a trick to give the block to the previously chosen company,’ said a Western analyst, who declined to be named.” *Auctions End on Contentious Note*, *Moscow Times*, dated 29 December 1995. See Expert Opinion Prof. Pieth October 2017 (**Exhibit RF-D14**, Annex MP-151), p. 2.

⁹⁹⁰ Gololobov Declaration (**Exhibit RF-WG2**), § 14.

UNOFFICIAL TRANSLATION

This text is an unofficial translation of the Dutch original. In case of any discrepancies, the Dutch original shall prevail.

“Kagalovsky said Monblan was unrelated to Menatep Bank, which organized the latest auction of the shares. ‘There is no connection between Monblan and Menatep. They are different organizations,’ he told reporters, adding he had no information about when or by whom Monblan was established.”⁹⁹¹

622. This statement was blatantly false (see §§ 526-529 above), however, as demonstrated by documents showing that Mr. Kagalovsky himself had instructed Mr. Anilionis to create ZAO Monblan.⁹⁹² Separately, a similar falsehood was told to the *Moscow Times*:

“Natalya Mandrova, a Menatep spokeswoman (...) said Laguna, Monblan and Yukos are expected to sign an agreement next month to settle their financial relations and other ownership issues. But she denied Menatep had any connection with Monblan.”⁹⁹³

623. In addition, the Russian Oligarchs also used a vast network of shell companies to keep their ownership of Yukos hidden until 2002. This network is described in the witness statements of Mr. Anilionis and Mr. Zakharov.

“7. The companies established by RTT after April 1995 would not engage in any business of their own. Rather, their function would be to hold the shares of other companies and, essentially, to conceal these companies’ actual ownership. (...)”⁹⁹⁴ (emphasis added)

624. Mr. Anilionis confirms that RTT established some 450-500 sham companies in the Russian Federation. In addition, some 100-120 entities have been established in foreign tax havens such as Cyprus and the British Virgin Islands.⁹⁹⁵ As described above, a large number of shells was involved in transferring the Yukos-shares from one entity to the other (see §569 et seq. above).⁹⁹⁶

⁹⁹¹ *Unknown Monblan Wins Third of Russia’s YUKOS*, Reuters, dated 23 December 1996. See Expert Opinion Prof. Pieth October 2017 (**Exhibit RF-D14**, Annex MP-153).

⁹⁹² Expert Opinion Prof. Pieth January 2017 (**Exhibit RF-D13**), §§ 41-42; “According to a schedule of tasks to prepare for this auction, one of Bank Menatep’s Board members, Mr. Kagalovsky (who previously had supervised the Loans-for-Shares auction on behalf of the State Property Committee) was to determine the minimum bid price for the auction, which he set at US\$ 160 million. Also according to that schedule, Mr. G.P. Anilionis, the executive director of RTT, was to ‘determine the buyers,’ create ‘holding companies’ for the auction participants, and create ‘holding companies for [the] holding companies.’” Schedule of Auction Events dated 1996. See Expert Opinion Prof. Pieth January 2017 (**Exhibit RF-D13**, Annex MP-025).

⁹⁹³ Sergey Lukyanov, ‘Managed’ Yukos Sale Fetches \$160M, *Moscow Times*, dated 24 Dec. 1996. See Expert Opinion Prof. Pieth January 2017 (**Exhibit RF-D13**, Annex MP-035).

⁹⁹⁴ Anilionis Declaration. (**Exhibit RF-200**), § 7.

⁹⁹⁵ Anilionis Declaration, (**Exhibit RF-200**), §§ 9-12.

⁹⁹⁶ See in great detail Expert Opinion Prof. Kothari 2015 (**Exhibit RF-202**).

625. Although it seemed as if the companies set up by RTT were independent entities, in reality these sham companies were controlled by the Russian Oligarchs. Indeed, Mr. Khodorkovsky served as the chairman of the board of directors of RTT, and RTT employees worked on the basis of personal instructions from Mr. Lebedev, Mr. Dubov, Mr. Golubovich and Mr. Khodorkovsky, among others. Mr. Anilionis stated:

"9. Although RTT's companies appeared to be independent and unaffiliated, actually all of these companies were de facto controlled by the principals of Bank Menatep and ZAO Rosprom. RTT thus provided a mechanism to ensure actual control and to ensure the confidentiality of such control. (...)"⁹⁹⁷

626. Mr. Anilionis and Mr. Zakharov both confirm that the Russian Oligarchs' deception was a strict internal policy.⁹⁹⁸ As Mr. Gololobov notes, the Russian Oligarchs' misrepresentations and sham transactions were indeed motivated by fear of "de-privatization."⁹⁹⁹ Specifically, the State Duma had expressly condemned the Yukos privatization in Resolution No. 3331-II, and demanded that President Yeltsin take steps to annul the privatization of Yukos and other fraudulently privatized entities.¹⁰⁰⁰

627. The Russian Oligarchs therefore wanted to prevent the illegal acquisition of the shares in Yukos from becoming known, as reflected in three different internal memoranda discussed by Mr. Gololobov:

"All three memos cautioned as follows: 'By disclosing the beneficiary holders of the shares and the vehicles they employed to purchase the shares the Company may instigate the revision of privatization results.'"¹⁰⁰¹

628. Mr. Gololobov thus explained that the Russian Oligarchs took careful precautions to protect the Yukos privatization from being reversed:

⁹⁹⁷ Anilionis Declaration (**Exhibit RF-200**), §§ 9-12.

⁹⁹⁸ Anilionis Declaration (**Exhibit RF-200**), § 15; Zakharov Declaration (**Exhibit RF-201**), § 6.

⁹⁹⁹ Gololobov Declaration (**Exhibit RF-WG2**), §§ 47-58.

¹⁰⁰⁰ Expert Opinion Prof. Pieth October 2017 (**Exhibit RF-D14**), § 85; *see also* Resolution of the State Duma of the Federal Assembly of the Russian Federation. No. 3331-II-GD dated 4 December 1998. *See* Expert Opinion Prof. Pieth October 2017 (**Exhibit RF-D14**, Annex MP-163).

¹⁰⁰¹ Gololobov Declaration (**Exhibit RF-WG2**), § 47 (quoting Email to Bruce Misamore dated 7 August 2002) with attachment "Business Proposal for Project Voyage" (CP6241-6251) (RME-3342); Memorandum from P.N. Malyi of Yukos to O.V. Sheyko dated Apr. 22, 2002 (RME-184); Memorandum from O.V. Sheyko to M.B. Khodorkovsky dated 14 May 2002 (**Exhibit RF-222**)).

"Essentially, RTT provided secretarial services related to the registration and upkeep of shell companies, which Bank Menatep, Rosprom, and Yukos used for a wide variety of purposes, including bid rigging, tax avoidance, avoidance of obligations under employment and environmental laws, obscuring the continued control of Yukos by the Oligarchs, circumvention of antimonopoly laws, and defense against the risk of de-privatization based on the illegal methods by which their Yukos shares were originally obtained. The employees of RTT acted as the shell companies' general directors, but made no decisions regarding these shell companies' activities without the express consent of the Oligarchs--usually communicated through either Mr. Moiseyev or Mr. Anilionis. Mr. Anilionis received some of RTT's instructions during regular meetings (which I also attended) at Mr. Khodorkovsky's headquarters on Kolpachny Lane." (emphasis added)

629. One of the Russian Oligarchs, Mr. Alexey Golubovich, has also confirmed that, after the auction in 1995 and 1996, the shares in Yukos were transferred specifically in order to reduce the risk that the validity of the auctions would be disputed:

"[Q]uestion: Why was it necessary to transfer the shares a month later? (...)

Response: For the most part this was done not only in relation to Yukos' privatization and in some other cases in order to reduce the legal risks if the results of the tender and loans-for-shares auction were disputed."¹⁰⁰²
(emphasis added)

630. As a final matter, HVY correctly observe that the Russian Oligarchs revealed certain aspects of the Yukos ownership structure in 2002. This was reflected in a three-page press release posted on the Yukos website, which explained which of the Russian Oligarchs owned how much of GML, which owned Hulley and YUL.¹⁰⁰³ This press release also acknowledged the role of VPL, which was allegedly controlled by an independent trustee in Jersey.¹⁰⁰⁴ This 2002 press release is, however, specifically noteworthy for what it does not disclose.
631. For example, the 2002 press release says nothing about the origin of the Russian Oligarchs' Yukos shares, or the circumstances of the Yukos privatization.¹⁰⁰⁵ The 2002 press release does not reveal that the Russian Oligarchs had owned their Yukos shares continuously

¹⁰⁰² Transcript of Golubovich's Second 2015 Interview **Exhibit RF-300**, p. 19

¹⁰⁰³ Information for the Management of OAO NK 'Yukos', GML, (C-597).

¹⁰⁰⁴ Information for the Management of OAO NK 'Yukos', GML, (C-597).

¹⁰⁰⁵ Expert Opinion Prof. Kothari 2015 (**Exhibit RF-202**), §§ 25-29; Expert Opinion Prof. Kothari 2017 (**Exhibit RF-D15**), § 52 et. seq., 68 and 80.

since 1995 and 1996, or that the Russian Oligarchs had concealed their Yukos shares for the previous six years by moving them to Cyprus and the Isle of Man through dozens of offshore companies, as explained by Professor Kothari.¹⁰⁰⁶ Nor does the 2002 press release correct any of the false statements made by Ms. Kagalovsky and Ms. Mandrova in December 1996.¹⁰⁰⁷

632. HVY's suggestion that the Yukos ownership structure was never concealed and never falsely misrepresented, therefore, is incorrect. Even if rumors about the truth were circulated in December 1995, the Russian Oligarchs' representatives told blatant falsehoods about the Yukos privatization in December 1996 and used elaborate sham transactions to hide the truth over the subsequent years.

(b) ***2006-2016 - The Russian Oligarchs Revealed Their Beneficial Ownership of GML and HVY, But Falsely Concealed Their Continuous Control of GML and HVY***

(b)(i) *Introduction: Russian Oligarchs deny control*

633. In the Statement of Appeal, HVY assert that the twenty-eight instances of criminal misconduct cannot be attributed to HVY, because they are allegedly “entities *separate from* the alleged culprits.”¹⁰⁰⁸ According to HVY, their allegedly “separate” status results from the fact that “*Hulley and YUL are owned and controlled by GML Ltd. and/or the trustees of the Guernsey trusts,*” while “*VPL is owned and controlled by the trustee of the Veteran Petroleum Trust*” based in Jersey.¹⁰⁰⁹ HVY's statements on this issue have also been consistently false, as explained below.

634. In 2003, significantly, the Russian Oligarchs transferred their GML shares to a group of trusts located in Guernsey. After the arbitrations began in 2005, HVY emphasized this fact

¹⁰⁰⁶ Ibid.

¹⁰⁰⁷ See *Unknown Monblan Wins Third of Russia's YUKOS*, Reuters, dated 23 Dec. 1996. See Expert Opinion Prof. Pieth October 2017 (**Exhibit RF-D14**, Annex MP-153); see also Sergey Lukyanov, ‘Managed’ Yukos Sale Fetches \$160M, *Moscow Times*, 24 Dec. 1996. See Expert Opinion Prof. Pieth January 2017 (**Exhibit RF-D13**, Annex MP-035).

¹⁰⁰⁸ SoA, § 807.

¹⁰⁰⁹ SoA, § 841.

UNOFFICIAL TRANSLATION

This text is an unofficial translation of the Dutch original. In case of any discrepancies, the Dutch original shall prevail.

repeatedly to the tribunal, acknowledging that the Russian Oligarchs indeed are the ultimate beneficial owners of both GML and HVY.¹⁰¹⁰

¹⁰¹⁰ During the Arbitrations HVY have provide an overview from which it is apparent that they are economically entitled (HEL Interim Awards, Appendix).

This text is an unofficial translation of the Dutch original. In case of any discrepancies, the Dutch original shall prevail.

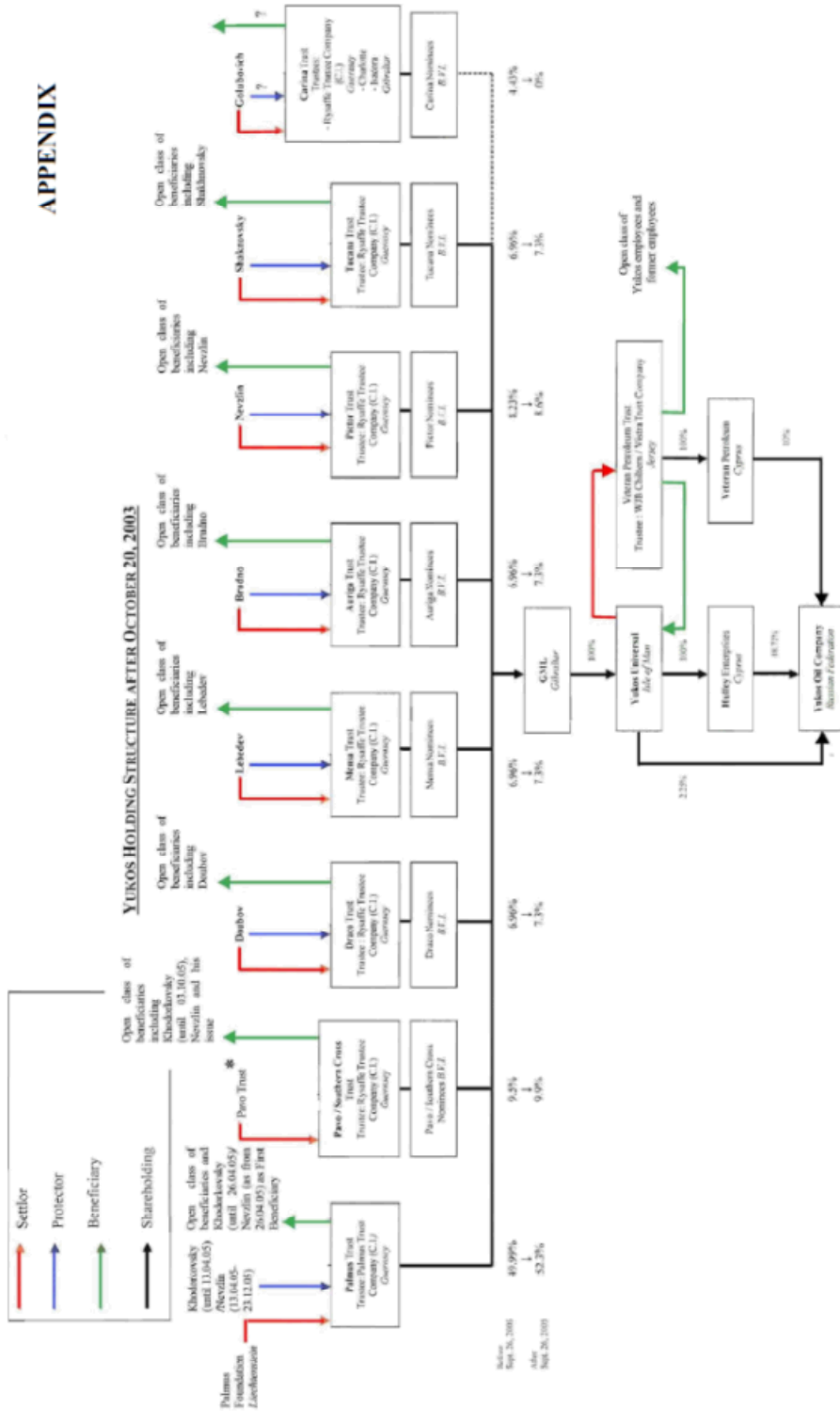

* The Southern Cross Trust is a declaration of trust constituted on April 26, 2003 by the appointment of the GMG - shares previously held in the Poro Trust of which Khokhlovsky was the settlor. The Southern Cross Trust has no Protectors.

635. But HVY categorically denied many times that the Russian Oligarchs exercise control over HVY. They claim that they should not be considered the legal owners of HVY. The legal ownership and control of HVY is allegedly vested in the trustees of the Guernsey and Jersey trusts.¹⁰¹¹ They have repeated this contention in the Statement of Appeal.¹⁰¹² These statements are blatantly false as revealed, in particular, by documents revealed since 2015.

(b)(ii) *The Russian Oligarchs withheld crucial documents evidencing control over HVY from the Tribunal*

636. In 2015 and 2016, HVY's contentions regarding the trustees' control of GML and VPL were shown to be demonstrably false. This follows from a series of newly disclosed documents and statements. As reflected in this new evidence, the Russian Oligarchs continue to control all meaningful aspects of HVY's business activities. The Russian Oligarchs make all serious decisions relating to HVY's multimillion-dollar financial transactions. The trustees in Guernsey or Jersey do not fulfill any meaningful role in this respect.

637. In ongoing litigation in New York,¹⁰¹³ business associates and employees of the Russian Oligarchs' have made claims and counter-claims against one another for fraud and embezzlement. In these proceedings, the following evidence was revealed for the first time:

(a) The 2011 Letter from GML to Mr. Bruce Misamore: As reflected in this letter, one of the Russian Oligarchs, Mr. Mikhail Brudno, has personally

¹⁰¹¹ See also SoD, Part I, § I.94: "94 (...) As the Tribunal concluded, HVY was owned and controlled by nationals of the United Kingdom and not of the Russian Federation:

- *Hulley and YUL are direct or indirect subsidiaries of GML Limited, a company incorporated under Gibraltar law. The shares of GML Limited are then held by seven trusts registered in Guernsey, which for the purposes of the ECT is considered part of the United Kingdom.*

- *VPL is a subsidiary of Veteran Petroleum Trust, registered in Jersey, which for the purposes of the ECT is considered part of the United Kingdom."* See in practically identical terms SoD, § II.366.

See also SoD, Part II, § II.368. "368. *If assets are held in a trust, it is the trustee of that trust - and not its beneficiary - who owns and controls the assets of the trust and exercises control over them. (...)*" See also SoD § 177-185.

¹⁰¹² SoA, §§ 733, 836.

¹⁰¹³ *Yukos Capital SàRL v. Feldman*, No. 15-cv-4964 (U.S. District Court for the Southern District of New York).

UNOFFICIAL TRANSLATION

This text is an unofficial translation of the Dutch original. In case of any discrepancies, the Dutch original shall prevail.

conducted negotiations on behalf of HVY with respect to a multimillion-dollar business transaction.¹⁰¹⁴ As explained in the judgment of the District Court of Amsterdam, the transaction concerns disbursements from two Dutch *Stichtings*. As shareholders of Yukos, HVY purport that they are entitled to these.¹⁰¹⁵ This letter reflects GML's agreement to pay a 10% kickback to, *inter alia*, Mr. Bruce Misamore, Mr. Michel de Guillenschmidt, and Mr. David Godfrey. HVY received approximately USD 250 million under this agreement from one of the *Stichtings*, while approximately USD 25 million was kicked back to the five directors of the *Stichtings*.¹⁰¹⁶ The fact that Mr. Mikhail Brudno participated directly and personally in these negotiations, whereas the Guernsey trustee is never mentioned, shows that the Russian Oligarchs freely circumvent the Guernsey trustee and directly close deals with third parties on behalf of HVY (such as the *Stichtings* and their directors).

¹⁰¹⁴ See Exhibit RF-321, re GML Agreement from 2011; Wolf Depo, Ex 3 - 2015-07-09 - GML Letter Confirming 225 million Disbursement; Feldman Amended Answer and Complaint dated 28 September 2016 (Exhibit RF-RF-302) pp. 41-42.

¹⁰¹⁵ Amsterdam Dist. Ct. 5 Nov. 2015, ECLI:NL:RBAMS:2015:7807 (*Promneftstroy v. GML, Hulley, YUL & VPL*); Feldman Amended Answer and Complaint (Exhibit RF-302) p. 36. For a discussion of the Dutch *Stichtings*, see Resp. C-Mem. on the Merits (Exhibit RF-03.1.B-3), §§ 528 et. seq.

¹⁰¹⁶ Amsterdam Dist. Ct. 5 Nov. 2015, ECLI:NL:RBAMS:2015:7807 (*Promneftstroy v. GML, Hulley, YUL & VPL*); Feldman Amended Answer and Complaint dated 28 September 2016 (Exhibit RF-302), p. 37.

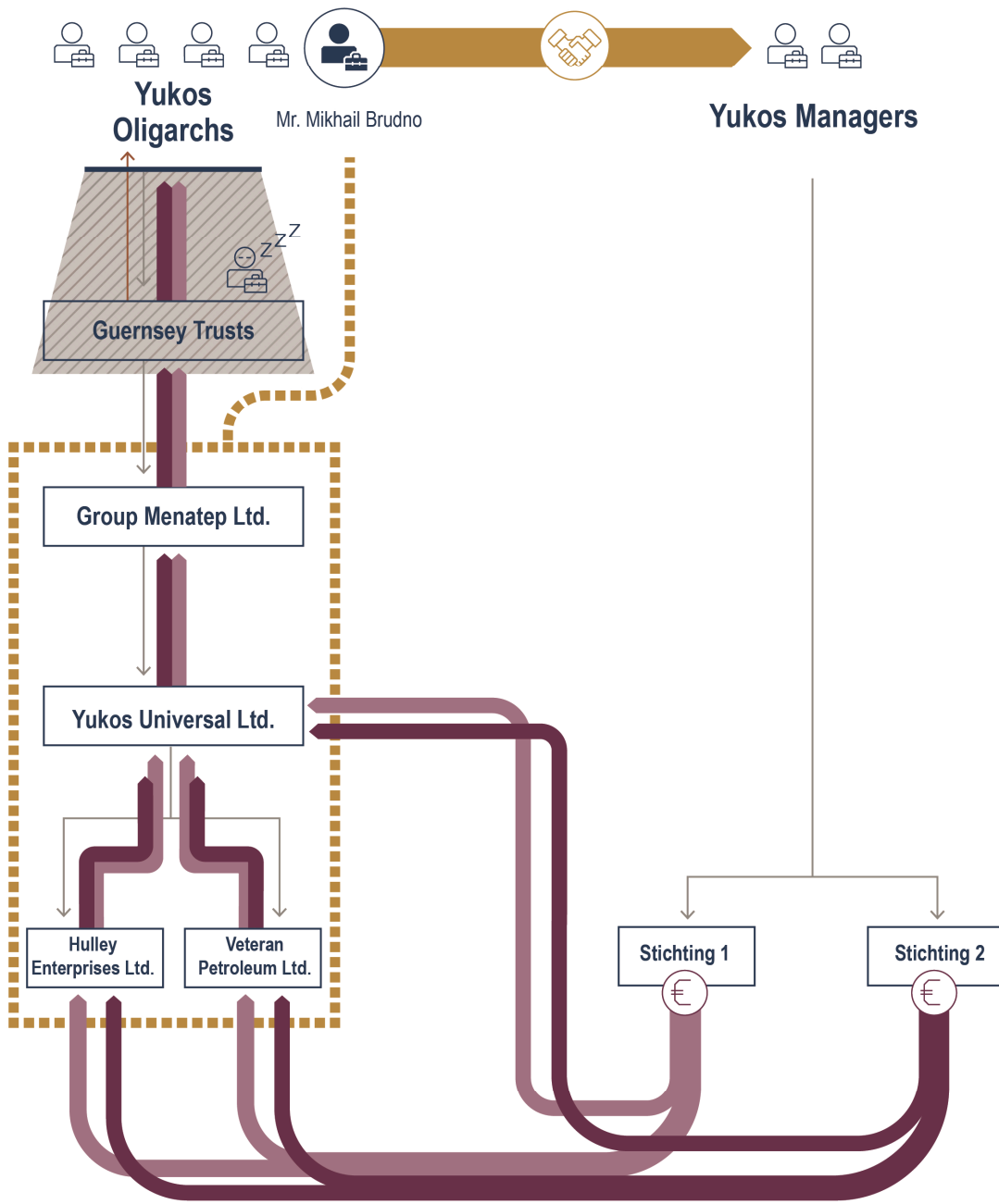

Legend



(b) Payments to Mr. Bruce Misamore and Mr. Michel de Guillenschmidt – The aforementioned 2011 letter is significant for another reason. Specifically, two of the recipients of GML’s kickback were the supposedly “independent” members of VPL’s Voting Committee, Mr. Misamore and Mr. de Guillenschmidt.¹⁰¹⁷ The third member of VPL’s Voting Committee was Mr. Platon Lebedev, who was himself one of the Russian Oligarchs.¹⁰¹⁸ Notably, the trustee in Jersey was obligated under the relevant trust agreement to vote the shares of VPL strictly in line with instructions from VPL’s Voting Committee. The 2011 letter shows, therefore, that the Jersey trustee’s supposed independence from GML and the Russian Oligarchs was simply an illusion, because these kickbacks would allow the Russian Oligarchs to direct and control the decisions of the Jersey trustee. But HVY never revealed these kickbacks to any of the expert witnesses¹⁰¹⁹ or the ECT arbitrators during the Arbitrations. They thus withheld critical information regarding who actually controlled VPL.

(c) Mr. Godfrey’s 2016 Deposition Statements Regarding the Rosneft Settlement
The Russian Oligarchs personally exercise the power to decide on multimillion-dollar business transactions concluded on HVY’s behalf. This is reflected in the sworn deposition of Mr. David Godfrey, a director of the Dutch *Stichtings*. He explained that he did not intend to negotiate a settlement agreement between Rosneft and the *Stichtings* until he had obtained the Russian Oligarchs’ prior authorization.¹⁰²⁰ He therefore went to meet specifically with Mr. Brudno to seek permission to enter into the settlement with Rosneft: “[W]ere they not to be in support of that, it would be a waste of my time, very substantial time, to actually make that

¹⁰¹⁷ Exhibit RF-321, re GML Agreement from 2011 (agreeing to pay kickbacks to Bruce Misamore and Michel de Guillenschmidt).

¹⁰¹⁸ Voting Instructions from VPL Voting Committee (2001-2006) identifying Bruce Misamore and Michel de Guillenschmidt as members of the VPL Voting Committee, together with Platon Lebedev (C-1169).

¹⁰¹⁹ See the Expert Opinions of Mr. Martin Mann QC of 27 January 2007 filed in the Arbitrations, which details that – under the law of Jersey – the allegations of VPL that it would be controlled by Chiltern Trust are wrong.

¹⁰²⁰ Deposition of Mr. David Godfrey dated 7 June 2016 (Exhibit RF-295).

happen.”¹⁰²¹ Mr. Godfrey did not suggest that the Guernsey trustees’ permission was also needed for the settlement, or that the Guernsey trustee participated in these negotiations in any respect. In the same deposition, Mr. Godfrey elaborated further regarding the role played by the Russian Oligarchs within GML. Specifically, he identified Mr. Brudno as “*one of the principals in the group we call core shareholders, so the people behind Menatep or GML,*” and he stated that Mr. Nevzlin is “*one of the so-called oligarchs who ultimately control Yukos through their shareholdings*” in GML.¹⁰²²

- (d) Mr. Wolf’s 2015 Deposition Statements Regarding the Promneftstroy Settlement. The Russian Oligarchs have also personally designated agents, such as Mr. Eric Wolf, a friend of Mr. Nevzlin. Mr. Wolf negotiated with a third party on behalf of HVY’s business interests.¹⁰²³ In a sworn deposition in 2015, Mr. Wolf explained: “*Mr. Nevzlin and his former partners have asked me to facilitate a negotiated settlement between Promneftstroy and Yukos.*”¹⁰²⁴ As compensation, Mr. Nevzlin evidently promised to pay another kickback to Mr. Wolf equal to “*a percentage of the funds received by his trust, by the trust of which he’s a beneficiary, in case of a reached and signed negotiated settlement*” between the *Stichtings* and Promneftstroy.¹⁰²⁵ This shows that only Mr. Nevzlin intervened on behalf of HVY in the multimillion-dollar settlement with Promneftstroy, just like Mr. Brudno had done before. It was Mr. Nevzlin, and not the Guernsey trustee, therefore who made key decisions on behalf of HVY.

¹⁰²¹ Deposition of Mr. David Godfrey dated 7 June 2016 (**Exhibit RF-295**).

¹⁰²² Deposition of Mr. David Godfrey dated 7 June 2016 (**Exhibit RF-295**), p. 434. (emphasis added).

¹⁰²³ Wolf Deposition, 5 October 2015 (**Exhibit RF-322**); Wolf Deposition, Exhibit 1, Emails between Eric Wolf, PNS, and Leonid Nevzlin (**Exhibit RF-322**).

¹⁰²⁴ Wolf Deposition, 5 October 2015 (**Exhibit RF-322**).

¹⁰²⁵ Wolf Deposition, 5 October 2015 (**Exhibit RF-322**).

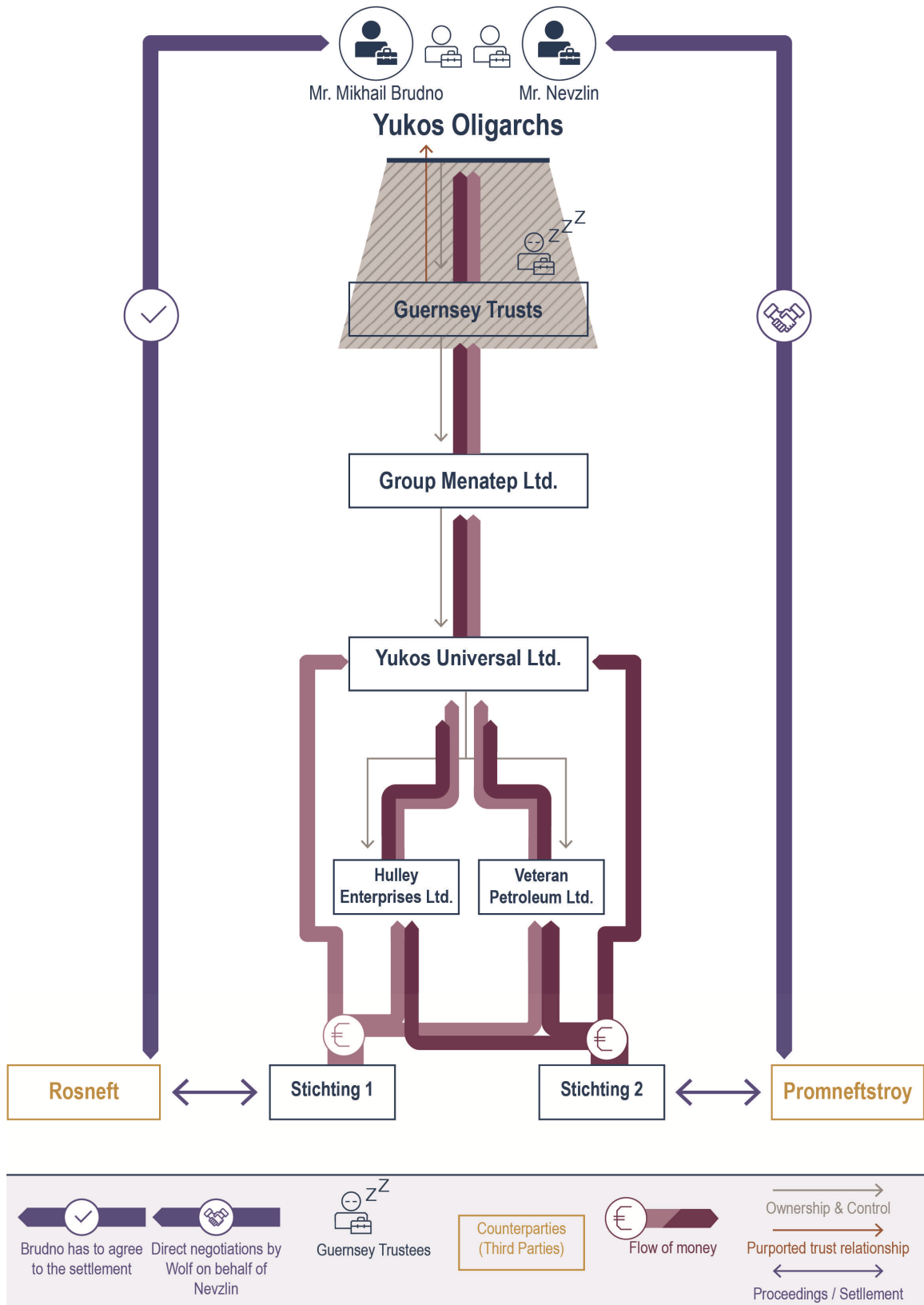

(e) Emails Exchanged between Mr. Wolf, Mr. Nevzlin, and GML – Mr. Wolf’s email exchanges with Promneftstroy in 2015 further reveal that the Oligarchs’ (and not the trustees) have been consistently involved in HVY’s management.¹⁰²⁶ Specifically, during settlement negotiations between the *Stichtings* and Promneftstroy, Mr. Wolf confirmed that he was authorized to act on behalf of the Russian Oligarchs and thus represented the “*principals whose money is actually on the line.*”¹⁰²⁷ Other emails demonstrate that Mr. Wolf was involved in “*several months of negotiations*”¹⁰²⁸ regarding the dispute with Promneftstroy. Indeed, as Eric Wolf stated explicitly, he was authorized to “*speak on behalf of the beneficiaries. Talking to [him is the] same as talking to Leonid and his former partners. They gave [Eric Wolf] the mandate.*”¹⁰²⁹ The “Leonid” referenced by Mr. Wolf, who also was copied on the same email, was Mr. Leonid Nevzlin. The Guernsey trustees are never mentioned in any of the emails between GML and Promneftstroy.

638. Notably, many documents pertaining to these issues should have been disclosed during the ECT arbitration under Procedural Order No. 12, which was issued on 16 September 2011.¹⁰³⁰ In particular, HVY was obligated to disclose the 2011 letter describing Mr. Brudno’s negotiations with the directors of the *Stichtings*, under which GML promised to pay kickbacks to two members of VPL’s Voting Committee.¹⁰³¹
639. Specifically, the ECT arbitrators’ Procedural Order No. 12 directed HVY to disclose all “[d]ocuments concerning any transaction or contemplated transaction related to Yukos shares” which involved “*Stichting Administratiekantoor Financial Performance Holdings*”

¹⁰²⁶ Wolf Deposition dated 5 October 2015 (**Exhibit RF-322**). Wolf Deposition, Exhibit 5 PNS Email re Settlement Negotiations with Eric Wolf (**Exhibit RF-322**); Wolf Deposition Exhibit 6 - PNS Email re Settlement Negotiations with Eric Wolf. (**Exhibit RF-322**).

¹⁰²⁷ Wolf Deposition, Exhibit 1, Emails between Eric Wolf, PNS, and Leonid Nevzlin (**Exhibit RF-322**).

¹⁰²⁸ Wolf Deposition, Exhibit 5 PNS Email re Settlement Negotiations with Eric Wolf; Wolf Deposition Exhibit 6 - PNS Email re Settlement Negotiations with Eric Wolf. (**Exhibit RF-322**).

¹⁰²⁹ Wolf Deposition, Exhibit 1, Emails between Eric Wolf, PNS, and Leonid Nevzlin. (**Exhibit RF-322**).

¹⁰³⁰ See Procedural Order No. 12 dated 16 September 2011.

¹⁰³¹ See, **Exhibit RF-321** re GML Agreement from 2011.

or “*Stichting Administratiekantoor Yukos International*.”¹⁰³² Procedural Order No. 12 also directed HVY to disclose all “*written communications to [HVY], the Oligarchs . . . or . . . affiliated entities concerning*” any “*disbursement, payment, or receipt of dividends, loans or other sums*” from the *Stichtings*.¹⁰³³ Procedural Order No. 12 also directed HVY to disclose all “*written communications to [HVY], the Oligarchs . . . or . . . affiliated entities concerning*” any “*arrangement[] relating to management or control*” of the *Stichtings*.¹⁰³⁴ The 2011 letter, notably, would be responsive to all three of these categories.

640. HVY, however, never produced the aforementioned 2011 agreement between GML and the directors of the *Stichtings* (see § 637 above). Nor did they disclose any communications regarding this agreement. HVY thus violated their “*continuing*”¹⁰³⁵ obligation to disclose such documents during the Arbitrations.¹⁰³⁶ HVY also never produced any “*minutes of meetings*” from the *Stichtings*’ “*corporate bodies*,” which were also responsive to Procedural Order No. 12,¹⁰³⁷ and also were in GML’s possession.¹⁰³⁸

¹⁰³² See Procedural Order No. 12, § 211 dated 16 September 2011 (**Exhibit RF-03.1.D-1.12**), requests for documents dated 17 June 2011 under 7.5. (**Exhibit RF-323**)

¹⁰³³ See Procedural Order No. 12, § 211 dated 16 September 2011 (**Exhibit RF-03.1.D-1.12**), requests for documents dated 17 June 2011 under 7.5. (**Exhibit RF-323**)

¹⁰³⁴ See Procedural Order No. 12, § 211 dated 16 September 2011 (**Exhibit RF-03.1.D-1.12**), requests for documents dated 17 June 2011 under 7.5. (**Exhibit RF-323**)

¹⁰³⁵ Procedural Order No. 12, §§ 90-93 dated 16 September 2011 (**Exhibit RF-03.1.D-1.12**). “*Respondent’s requests for documents from non-party sources include what it has defined as Yukos Documents, GML Documents and Oligarch Documents. Where the Tribunal has granted a request in respect of such documents, Claimants must produce all documents from these sources that are in Claimants’ possession, custody or control (...) The Tribunal reminds the parties that the obligation to disclose requested documents is of a continuing nature. A party that subsequently learns that it possesses, or obtains possession from another source, of a document or class of documents previously required to be disclosed to the other party, has a duty to make an immediate disclosure.*”

¹⁰³⁶ The Russian Federation did insist on compliance with the Procedural Order as follows from the letter sent to Shearman & Sterling LLP on 6 February 2012, at 3 & n.2 (**Exhibit RF-323**) (“*Claimants have produced certain GML financial statements in response to request 4.2 . . . and (redacted) GML bank account statements in response to request 7.1 These disclosures demonstrate that Claimants have access to documents from GML or its principals when Claimants desire. However, Claimants have not produced other responsive documents from GML or its principals. For example, Claimants have produced nothing in response to Respondent’s requests 1.7 and 2.5 for documents concerning Yukos’ chain of ownership since privatization.*”).

¹⁰³⁷ See Procedural Order No. 12, § 21 dated 16 September 2011 (**Exhibit RF-03.1.D-1.12**).

¹⁰³⁸ See Declaration of Tim Osborne re Minutes of the *Stichtings* of 21 October 2015 (*Feldman* ECF No. 68, (**Exhibit RF-324**)) Original English text: “*In the course of my service as a Foundation Director, I received copies of confidential Board of Director meeting minutes . . .*”; see also *Stichting* Minutes 11 September 2008 (San Francisco) (*Feldman* ECF No. 62-6) (**Exhibit RF-325**); *Stichting* Minutes dated 18 March 2008 (New York) (*Feldman* ECF No. 62-5) (**Exhibit RF-326**); *Stichting* Minutes dated 9 March

641. But for HVY's intentional violation of the document-disclosure orders, the arbitrators never would have erroneously concluded that "*Bank Menatep and the Oligarchs*," were actually "*an entity and persons separate from [HVY]*." ¹⁰³⁹ That the Tribunal's conclusion that HVY were "separate from" the Russian Oligarchs is incorrect, is further confirmed by the aforementioned documents that were revealed in 2015 and 2016 (see § 637 above).

(b)(iii) *Witnesses confirm that the Russian Oligarchs control HVY*

642. As is confirmed by the declarations of Mr. Anilionis¹⁰⁴⁰ and Mr. Zakharov,¹⁰⁴¹ the corporate structure designed by the Russian Oligarchs has been used for decades to conceal ownership and control. Part of this corporate structure is comprised of the trusts in Guernsey and Jersey, which are sham entities that perform no genuine business purpose.

643. Jersey and Guernsey are tax havens. It is well established that shell entities incorporated in these jurisdictions have been involved in fraud, tax evasion and money laundering.¹⁰⁴² Trusts in these jurisdictions often serve to conceal ownership and control.¹⁰⁴³ Trust companies in these jurisdictions that render services as trustees are above all service providers that exclusively act upon instructions of their clients. The Panama Papers confirm that trustees often actively facilitate to obscure ownership and control.¹⁰⁴⁴

2010 (Houston) (*Feldman* ECF No. 62-4) (**Exhibit RF-327**); Stichting Minutes dated 28 June 2011 (New York) (ECF No. 62-2) (**Exhibit RF-328**).

¹⁰³⁹ Final Awards marginal nos. 1369-1370.

¹⁰⁴⁰ Anilionis Declaration (**Exhibit RF-200**).

¹⁰⁴¹ Zakharov Declaration (**Exhibit RF-201**).

¹⁰⁴² The Ministry of Finance regularly issues specific guidelines for e.g. lawyers and accountants that list indicators and red flags for unusual transactions. These guidelines serve to apply the legislation to prevent money laundering and financing of terrorism (Money Laundering and Financing Terrorism Prevention Act). These guidelines show that inter alia Guernsey and Jersey (as well as Cyprus and the BVI are considered high risk jurisdictions. See e.g. the Specific Guidelines on Compliance with the Money Laundering and Financing Terrorism Prevention Act for Lawyers and Legal Service Providers 2011 (specifieke leidraad naleving WWFT voor advocaten en juridisch dienstverleners zoals genoemd in artikel 1 lid 1 letter a sub 12 en 13 WWFT, 2011, onder 4.2).

¹⁰⁴³ Numerous official documents that aim to prevent fraud, tax evasion and money laundering show that the use of trusts are an important indicator for abuse. See e.g. the 2009 OECD Money Laundering Awareness Handbook for Tax Examiners and Tax Auditors', available at <http://www.oecd.org/cleangovbiz/toolkit/moneylaundering.htm>. Which states on p. 23: "*An important tool for the concealment of the true beneficial owner is the use of offshore entities, such as trusts or offshore corporations.*"

¹⁰⁴⁴ Trustee companies hired by the Russian Oligarchs are specifically mentioned in the exposed Panama Papers. See www.icij.org. In the database, one finds the name of the trustee of most of the Guernsey trusts, the Rusaffe Trustee Company. One can also search the names of individuals. For example, the

644. The trustees of the Guernsey trusts are strawmen that are in fact controlled by the (most important) Russian Oligarchs. This has recently been confirmed by one of the Oligarchs. Mr. Golubovich conceded:

"(...) Generally speaking, the system of holding shares in Menatep Group through trusts was set up, as far as I know, pursuant to the decision of Mikhail Borisovich Khodorkovsky, in such a way that a person he deems essential, i.e., himself, Platon Lebedev or Nevzlin, or some other person in order of priority (...) always has control over the shares (...) It is a fairly complex structure. I explained in very broad outlines how I understand it, but the essence of it is that control over all the shares of Menatep Group via these trusts was in any case exercised by the head of the group, who was able to appoint the trustees."¹⁰⁴⁵ (emphasis added)

645. Mr. Gololobov has confirmed that the Russian Oligarchs directly control HVY. According to him, the creation of the trusts did not practically or factually alter this:

"GML was owned outright by the Oligarchs, until 2003 when they placed their shares in GML in a number of individual trusts: the Draco Trust (for Mr. Dubov), the Mensa Trust (for Mr. Lebedev), the Auriga Trust (for Mr. Brudno), the Pictor Trust (for Mr. Nevzlin), and the Tucana Trust (for Mr. Shakhnovsky). The Palmus Trust and the Pavo Trust also held GML shares; Mr. Khodorkovsky was initially the beneficiary of these trusts, but in 2005 this interest was transferred to Mr. Nevzlin. I note that the creation of these trust structures had no practical effect on the ability of the Oligarchs to direct the actions of GML and, therefore, exercise complete control over Yukos."¹⁰⁴⁶

D. Conclusion

646. The evidence thus reflects that the Russian Oligarchs' tactics have been consistent from the mid-1990s until today. During the Yukos privatization, the Russian Oligarchs abused sham companies to disguise both their identities and their payments of bribes to public officials. During the years of Yukos operations, the Russian Oligarchs abused shell companies once again to commit fraudulent tax evasion. They concealed the true character and source of their Yukos-related income and abused the Russia-Cyprus DTA as well as low-tax regimes in certain regions in the Russian Federation. After the tax authorities began their enforcement efforts, the Russian Oligarchs once again abused shell companies to strip cash and assets out of Yukos and conceal their illegally-obtained wealth around the world. HVY

Russian Oligarch Golubovich, his wife and children are linked with a large number of obscure corporations.

¹⁰⁴⁵ Golubovich Declaration (**Exhibit RF-300**), pp. 7-8.

¹⁰⁴⁶ Gololobov Declaration (**Exhibit RF-G2**), § 26.

are nothing but offshore shell companies, created for these same unlawful and abusive purposes.

647. The Russian Oligarchs are now attempting to use precisely the same deception before the Courts of the Netherlands that they used before the ECT arbitrators. Once again, the Russian Oligarchs are using HVY to disguise their identities and present themselves as “foreign investors,” when in fact they are Russian criminals. There can be no doubt, however, about who is ultimately behind HVY, and who is actually in control. It concerns the very same Russian Oligarchs who first stole Yukos from the Russian people in 1995 and 1996, then evaded taxes for billions of dollars, and subsequently siphoned those billions out of the Russian Federation through HVY.
648. This is a case between Russians and the Russian Federation on the question of whether the Russian Oligarchs may yet again deprive the Russian people of yet another USD 50 billion plus interest. As the facts reflect, such a result would contravene fundamental principles of international law, public policy, and the rule of law in its most basic sense.

IV. GROUND FOR SETTING ASIDE 1 (CONTINUED) - NO VALID ARBITRATION AGREEMENT (ARTICLE 1065(1)(A) DCCP)

A. Introduction

649. In the first instance, the Russian Federation argued that the Yukos Awards should be set aside, *inter alia* because of a lack of a valid arbitration agreement. The Tribunal had no jurisdiction to hear the dispute pursuant to Article 26 ECT because, in short,
- (a) Article 45 ECT only provides for a limited provisional application of the ECT (Jurisdiction Ground 1);
 - (b) HVY and their shares in Yukos are not protected under the ECT (Jurisdiction Ground 2); and
 - (c) According to Article 21 ECT, the Russian Federation's taxation measures do not fall under the ECT's scope of application (Jurisdiction Ground 3).
650. In an very well-reasoned Judgment, the District Court set aside the Yukos Awards already on the basis of the first ground for setting aside – Jurisdiction Ground 1 (Article 45 ECT). This ground was extensively discussed in the previous chapter. The Russian Federation will discuss the other two Jurisdiction Grounds in this chapter.

B. Legal Framework

651. The fundamental character of the right to access to court entails that it is ultimately the civil court that must answer the question whether a valid arbitration agreement has been concluded.¹⁰⁴⁷ According to established case law, therefore, the validity of the arbitration agreement should not be reviewed with restraint.¹⁰⁴⁸ The district court was right to confirm this in its Judgment in the first instance:

“5.4 (...) This fundamental character also entails that, in deviation from a principally restrictive assessment in reversal proceedings, the court does not restrictively assess a request for reversal of an arbitral award on the ground of a lacking valid agreement (cf. recent Supreme Court ruling of 26 September 2014, ECLI:NL:HR:2014:2837). (...)”

652. Furthermore, the burden of proof with regard to the existence of a valid arbitration agreement is on the party relying on it. This is also true for the setting aside proceedings which are, indeed, an extension of the arbitration. The burden of proof with regard to the validity of the arbitration agreement is therefore on HVY.¹⁰⁴⁹ The district court was right to confirm that in its Judgment in the first instance:

"5.4 (...) Furthermore, in assessing such a request, the court takes as a starting point that the onus is on the defendants to prove that the Tribunal is competent. After all, the burden of proof was also on them (as Claimants) in the Arbitration, while in the current proceedings the same jurisdiction issue is to be dealt with."

653. Finally, the Russian Federation remarks that in the case law arbitral awards are also regularly set aside on the basis of Article 1065(1)(a) DCCP.¹⁰⁵⁰

C. Jurisdictional Ground 2 – The Tribunal lacked jurisdiction because the ECT does not protect HVY nor HVY's shares in Yukos

The Russian Federation refers to:		
Arbitrations:		
HEL Interim Award	Chapter VIII.B	marginal nos. 399 - 435

¹⁰⁴⁷ Supreme Court 9 January 1981, ECLI:NL:HR:1981:AG4130, *NJ* 1981/203 (*De Raad/Wagemaker*), Supreme Court 27 March 2009, *NJ* 2010/170; *TvA* 2009/50, p. 131 (*Smit Bloembollen c.s./Ruwa Bulbs*), ground 3.4.1 and Supreme Court 26 September 2014, ECLI:NL:HR:2014:2837, *NJ* 2015/318 (*Ecuador/Chevron*).

¹⁰⁴⁸ Writ, §§ 107 et seq.

¹⁰⁴⁹ In chapter II.E(d), the Russian Federation discussed this in detail. See furthermore the Expert Opinion of Professor Snijders (**Exhibit RF-D9**).

¹⁰⁵⁰ See the 12 examples mentioned in SoR, fn. 43.

UNOFFICIAL TRANSLATION

This text is an unofficial translation of the Dutch original. In case of any discrepancies, the Dutch original shall prevail.

Setting aside proceedings:		
Writ	Chapter IV.D	§§ 248 - 276
SoD	Part I, Chapter 3.2.3	§§ 1.85 - 95
	Part II, Chapter 2.2	§§ II.314 - 373
SoR	Chapter III.D	§§ 220 - 273
SoRej	Chapter 2.3	§§ 146 - 198
RF Pleading Notes	Chapter IV	§§ 27 - 51
HVY Pleading Notes	Chapter 1.3	§§ 71 - 80
SoA	Part II, Chapter 9	§§ 722 - 740

Primary exhibits:	
Arbitrations:	
RME-3328 (RF-03.2.C-2.3328)	OAo Neftyanaya Kompaniya Yukos v. Russia, ECHR, Appl. No 14902/04, Judgment (Sept. 20, 2011) ("First ECtHR Ruling")
Setting aside proceedings:	
RF-04	Khodorkovskiy and Lebedev v. Russia, ECtHR, Appls. Nos. 11082/06 and 13772/05, Judgment (July 25, 2013)("Second ECtHR Ruling")
RF-200	Statement Anilionis
RF-201	Statement Zakharov
RF-202	Kothari Report
RF-203	Asoskov Report

Essence of the argument

- Under Article 1065(1)(a) DCCP, the Yukos Awards must be set aside by reason that the Tribunal lacked jurisdiction: HVY cannot rely on the arbitration provision of Article 26 ECT, given that HVY and their shares in Yukos do not fall under the ECT's protection, they are fake foreign investors (*nep buitenlandse investeerders*) and have a fake foreign investment for the following reasons.
- The ECT is concerned with foreign investments, and offers no protection in investment disputes between states and their own nationals.

HVY are sham companies that are beneficially owned and controlled by the Russian Oligarchs.

HVY are not 'Investors' and did not make any 'Investments' within the meaning of Article 1(6) and (7) ECT, given that the ECT's protection does not extend to 'U-turn' investments (State A – State B – State A). This follows – per Article 31 VCLT – from the object and purpose of the ECT, the context and the principles of international law and is confirmed by subsequent state practice.

HVY did not make an 'Investment' within the meaning of the ECT, given that they did not make any foreign economic contribution within the Russian Federation.

The Russian Oligarchs abused HVY's corporate shell for illegal purposes, amongst which tax evasion. This justifies piercing the corporate veil in order to expose

these Russian nationals behind HVY.

- The ECT's protection does not extend to HVY and their shares in Yukos, in light of the criminal and unlawful backgrounds and acts of HVY and the Russian Oligarchs.
- The Russian Federation put forward its objections to the widespread illegal methods of HVY and the Russian Oligarchs in the Writ; it has not waived those objections, either under Dutch law or under international law.

(a) ***Introduction***

654. Article 1065(1)(a) DCCP also requires set-aside of the arbitral Awards on the jurisdictional ground that the ECT does not protect HVY's shares in Yukos.¹⁰⁵¹
655. As set forth below in Section B, HVY are not "Investors" and their shares are not "Investments" under Articles 1(6) and 1(7) of the ECT because the Treaty does not protect round-trip investments by host State nationals through shell companies incorporated in offshore tax havens. A proper contextual reading of the Treaty, consistent with the ECT's object and purpose and fundamental principles of international law – as prescribed by the Vienna Convention on the Law of Treaties – confirms that the ECT serves to promote and protect international investment by foreign investors. The ECT does not provide protection or recourse for Russian nationals looking to pursue claims against their own State. The record establishes – undisputed – that HVY are each shell companies with no economic substance, beneficially owned and controlled by the Russian Oligarchs, that made no economic contribution in the Russian Federation through their purported investments. They are "fake foreign investors". The ECT does not accord investment protections in such circumstances.
656. These circumstances are, in and of themselves, sufficient to deny protection to HVY as "investors" or to their alleged "investments" under the ECT. In addition, through their fraud, bribery, and collusion, HVY and the Oligarchs illegally acquired their interests in Yukos, deprived the State of the benefit of its natural resources, committed tax evasion on a massive scale, and siphoned billions of dollars to offshore accounts. These (and other) abuses and outright, pervasive illegality by HVY and the Oligarchs have been addressed at

¹⁰⁵¹ See, e.g., Writ, §§ 20, 101, 248-276; SoR, §§ 12-13, 220-273; Pleading Notes RF §§ 27-51.

This text is an unofficial translation of the Dutch original. In case of any discrepancies, the Dutch original shall prevail.

length in the Writ, the Reply, the Pleading Notes, and this Defence on Appeal.¹⁰⁵² And, as set forth below in Section C, the ECT also does not protect investments made in violation of law, as HVY's purported investments plainly were.

657. Accordingly, even setting aside the question of provisional application of the ECT, neither HVY nor their Yukos shares were eligible for investment protection under the ECT, and HVY could not accept any alleged offer for arbitration under the ECT.

(b) ***The ECT Does Not Protect HVY's Yukos Shares Because They Are, At Bottom, Investments By Russian Nationals In Russia***

(b)(i) *HVY Are Shell Companies, Beneficially Owned And Controlled By Russian Nationals For Illicit Purposes*

658. A shell company is defined broadly as "a non-operational company – that is, a legal entity that has no independent operations, significant assets, ongoing business activities, or employees."¹⁰⁵³ It is widely recognized that shell companies often are used as vehicles for illegal activities by the parties that own and control them, including corruption, money-laundering, tax evasion, and other offenses:

Shell companies do not employ workers, sell products, or conduct any other substantive business. But because corporations are 'legal persons,' they can shield owners from legal liability and hide identities while enabling people to move millions – or even billions – of dollars around the world in ways that are impossible to trace. . . . Shell companies are also one of the most common devices used in major corruption offenses.¹⁰⁵⁴

¹⁰⁵² See, e.g., Writ, §§ 26-60; SoR, §§ 26-33; Pleading Notes RF § 47; See also chapter III above.

¹⁰⁵³ English original: "a non-operational company – that is, a legal entity that has no independent operations, significant assets, ongoing business activities, or employees", see Stolen Asset Recovery Initiative, *The Puppet Masters: How the Corrupt Use Legal Structures to Hide Stolen Assets and What to Do About It* (2011), at 34 (**Exhibit RF-329**). See also Shima Baradaran, Michael Findley, Daniel Nielson, and Jason Sharman, *Funding Terror*, 162 U. OF PENNSYLVANIA LAW REVIEW (No. 3, 2014) at 477, 492 (**Exhibit RF-330**) ("A shell company is a business entity with no significant assets or ongoing business activities, which is capable of transferring large sums of money worldwide. 'Shell companies . . . typically have no physical presence other than a mailing address, employ no one, and produce little to no independent economic value."); David H. Fater, *ESSENTIALS OF CORPORATE AND CAPITAL FORMATION* (2010), at 218 (**Exhibit RF-331**) ("A shell corporation (or shell company) is a company that has no significant assets or operations.").

¹⁰⁵⁴ English original: "Shell companies do not employ workers, sell products, or conduct any other substantive business. But because corporations are 'legal persons', they can shield owners from legal liability and hide identities while enabling people to move millions – or even billions – of dollars around the world in ways that are impossible to trace (...). Shell companies are also one of the most common devices used in major corruption offenses." See GLOBAL SHELL GAMES: EXPERIMENTS IN TRANSNATIONAL RELATIONS, CRIME, AND TERRORISM (Michael G. Findley & Daniel L. Nielson eds., 2014), at 9, 36 (**Exhibit RF-332**); see also U.S. Money Laundering Threat Assessment (Dec. 2005), at

659. In his expert report analyzing documentary evidence of bribery, corruption, and money laundering in this case, Professor Mark Pieth confirms that “[t]ransmitting payments through offshore shell entities makes it far more difficult to trace the actual beneficiaries of payments and is therefore a common strategy for concealing illegal payments.”¹⁰⁵⁵
660. Within the context of international investment treaty claims, it is similarly well established that shell companies also have been abused by investors to disguise their identity and involvement in an investment, as well as to “treaty shop” by using the nationality of the shell entity as a predicate for claims that the ultimate investor itself could not bring.¹⁰⁵⁶
661. HVY have long conceded that they are shell companies and that the Russian Oligarchs are their ultimate beneficial owners. That is, HVY have conceded that each “does not engage in any substantial business activity in its place of organization (or elsewhere)” other than holding Yukos shares and collecting dividends or other disbursements based on their respective Yukos shareholdings.¹⁰⁵⁷ HEL and YUL also have conceded that they are

47-48 (**Exhibit RF-333**) (“Legal entities such as shell companies and trusts are used globally for legitimate business purposes, but because of their ability to hide ownership and mask financial details they have become popular tools for money launderers. The use of these legal structures for money laundering is well-established.”); U.S. Government Accountability Office, *Company Formations: Minimal Ownership Information Is Collected and Available* (Apr. 2006), at 31 (**Exhibit RF-334**) (“Law enforcement officials and other reports indicate that shell companies have become popular tools for facilitating criminal activity, particularly laundering money.”).

¹⁰⁵⁵ English original: “[t]ransmitting payments through offshore shell entities makes it far more difficult to trace the actual beneficiaries of payments and is therefore a common strategy for concealing illegal payments.” First Expert Report of Prof. Pieth § 129 (**Exhibit RF-D13**).

¹⁰⁵⁶ See, e.g., Rachel Thorn & Jennifer Doucleff, *Disregarding the Corporate Veil and Denial of Benefits Clauses: Testing Treaty Language and the Concept of “Investor,”* in THE BACKLASH AGAINST INVESTMENT ARBITRATION: PERCEPTIONS AND REALITY (Michael Waibel et al. eds., 2010), at 3-4 (**Exhibit RF-335**) (noting that a shell entity “has no real connection with the relevant contracting party” and “operat[es] merely as a front for the real party in interest,” and that the reason for creating a “shell” company may be “undesirable treaty shopping” or an “attempt to evade the jurisdiction of national courts”); INTERNATIONAL ARBITRATION AND MEDIATION – FROM THE PROFESSIONAL’S PERSPECTIVE (Anita Alibekova & Robert Carrow eds., 2007), at 222 (**Exhibit RF-336**) (explaining that shell companies “take very little part in any material decisions, which might be made regarding its investment, which will be made by the ultimate investors – the real investors who may not be incorporated in a State which has a BIT with the host State”); ALTERNATIVE VISIONS OF THE INTERNATIONAL LAW ON FOREIGN INVESTMENT: ESSAYS IN HONOUR OF MUTHUCUMARASWAMY SORNARAJAH (C.L. Lim ed., 2016), at 208 (**Exhibit RF-337**) (“Often mailbox or shell companies are formed with nominal existence in a state where the investment treaty has the most convenient provisions. . . . This misuse is undertaken for two purposes: forum shopping and round-tripping.”).

¹⁰⁵⁷ English original: “does not engage in any substantial business activity in its place of organization (or elsewhere)”, see Letter from HVY to the Arbitral Tribunal dated 3 Nov. 2006, at 2 (Annex (Merits) C 1396); see also HEL Counter-Memorial on Jurisdiction and Admissibility § 288 (conceding that Hulley had “no substantial business activity in [its place of incorporation] within the meaning of Article 17(1) ECT”); YUL Counter-Memorial on Jurisdiction and Admissibility § 287 (same for YUL); VPL Counter-Memorial on Jurisdiction and Admissibility § 290 (same for VPL).

immediately controlled by the Gibraltar-based holding company, GML, which is controlled in turn by a group of trusts based on the Isle of Guernsey, a crown dependency of the United Kingdom.¹⁰⁵⁸ Finally, at the top of GML's ownership structure, the beneficiaries of these Guernsey trusts are the Russian Oligarchs themselves: Leonid Nevzlin, Vladimir Dubov, Mikhail Brudno, Platon Lebedev, and Vasily Shakhnovsky.¹⁰⁵⁹ For its part, VPL concedes that virtually all of the economic benefits derived from its Yukos shares (including dividends, disbursements, and any potential proceeds from the sale of Yukos shares) must likewise be paid to YUL under a trust agreement – such that those economic benefits will also, ultimately, find their way back to the Russian Oligarchs.¹⁰⁶⁰

662. Today, these shell entities continue to have no apparent business operations. As just one example, a recent site visit to Hulley's registered office address in Cyprus revealed that it does not have even a superficial presence there. Hulley's registered address, per the Cypriot Registrar of Companies, is 59-61 Akropoleos Avenue, Floor 3, Office 301, Strovolos, p.c. 2012 Nicosia.¹⁰⁶¹ At that address, there is no office, sign, or mailbox bearing the Hulley name.¹⁰⁶² Signs onsite identify the occupants of that office as DCW I.T. Consulting Limited and AccordServe Business Services, an administrative services provider.¹⁰⁶³

¹⁰⁵⁸ See *supra* §§ 633-635.

¹⁰⁵⁹ See *supra* §§ 636-637.

¹⁰⁶⁰ See *supra* §§ 636-641.

¹⁰⁶¹ Declaration of Achilleos § 3 (**Exhibit RF-G5**) & Search Record of Cypriot Registrar of Companies (Achilleos Exh. 1).

¹⁰⁶² Declaration of Achilleos §§ 4-5 (**Exhibit RF-G5**) & Office Photographs (Achilleos Exhs. 2-5).

¹⁰⁶³ *Id.* See also Declaration of Achilleos § 7 (**Exhibit RF-G5**) & Search Record of ICPAC Website (Achilleos Exh. 7).

UNOFFICIAL TRANSLATION

This text is an unofficial translation of the Dutch original. In case of any discrepancies, the Dutch original shall prevail.



663. In fact, corporate records indicate that Hulley is one of 323 different companies claiming that office as its address.¹⁰⁶⁴ In other words, this shell company – sometimes also called a “mailbox” company – does not even have its own mailbox at its registered address. Instead, it appears to exist only on paper.
664. While making significant concessions confirming their shell form, HVY repeatedly have insisted that they are nonetheless “separate from”¹⁰⁶⁵ the Russian Oligarchs because they allegedly are not *controlled by* the Russian Oligarchs. In their Statement of Appeal, for example, HVY state that “*HVY are ultimately owned and controlled by trustees under the*

¹⁰⁶⁴ Declaration of Achilles § 6 (**Exhibit RF-G5**) & Search Record of Open Corporates Website (Achilleos Exh. 6).

¹⁰⁶⁵ English original: “*separate from*”, see SoA, § 806 with reference to Final Awards, marginal 1370.

*laws of the United Kingdom.*¹⁰⁶⁶ Likewise, before the District Court, HVY asserted that "*HVY are not indirectly owned and controlled by Russian individuals but (ultimately) by the respective trustees. These trustees are nationals of the United Kingdom, not of Russia*¹⁰⁶⁷ [*Accordingly,*] *the trustees, rather than the [Russian] beneficiaries, are the owners of and control the assets of the trusts.*"¹⁰⁶⁸ Indeed, as detailed above, HVY and their lawyers repeatedly have made the same representations in the public domain and throughout the ten years of the arbitration.¹⁰⁶⁹

665. These representations, however, have always been false – and now demonstrably so. This is established, in particular, in numerous new documents disclosed since 2015 by HVY's and the Russian Oligarchs' associates. As detailed above in chapter III.C(b), most of this compelling new evidence became known as a result of ongoing court proceedings in New York, where the Russian Oligarchs' associates are presently litigating a number of different fraud and embezzlement claims against one another.¹⁰⁷⁰ As reflected in this new evidence, the Russian Oligarchs have always controlled, and still continue to control all meaningful aspects of HVY's business activities, while excluding the Guernsey and Jersey trustees from making any significant decisions.¹⁰⁷¹ The trustees' supposed control over HVY is wholly illusory – despite HVY's repeated false statements to the contrary before the international arbitrators, the District Court, and this Court.
666. The extensive evidence, moreover, demonstrates that the Russian Oligarchs have used their ownership and control to abuse HVY's shell form from their inception for a wide spectrum of illicit purposes, including to pay at least USD 613.5 million in bribes to the Red Directors through sham contracts concluded by YUL; to conceal the ownership and control structure of Yukos, including the identities of the Oligarchs,¹⁰⁷² to prevent de-privatization as a consequence of the illegal Yukos share acquisitions in 1995 and 1996,¹⁰⁷³ to channel

¹⁰⁶⁶ SoA, § 733.

¹⁰⁶⁷ Pleading Notes HVY, § 16.

¹⁰⁶⁸ Pleading Notes HVY, § 79.

¹⁰⁶⁹ *See supra* chapter III.C(b).

¹⁰⁷⁰ *See supra* chapter III.C(b).

¹⁰⁷¹ *See supra* § 637.

¹⁰⁷² *See supra* chapter III.C.

¹⁰⁷³ *See supra* § 628.

the Oligarch's ill-gotten riches (including the illegally-obtained Yukos shares) out of the Russian Federation;¹⁰⁷⁴ to evade taxes on a massive scale, including through fraudulent abuses of the 1998 Double-Taxation Agreement between the Russian Federation and Cyprus;¹⁰⁷⁵ and to pursue international law claims under the ECT for a fundamentally Russian domestic dispute involving only parties and events in Russia.¹⁰⁷⁶

667. Accordingly, HVY's assertion that they are juridical entities "separate from" the Russian Oligarchs is unsustainable. The Russian Oligarchs are not only the creators and ultimate beneficial owners of HVY, but also the only individuals with the power to control HVY and make significant decisions regarding HVY's business activities – including decisions driven to abuse HVY's corporate form for the benefit of the Russian Oligarchs. These facts give rise to significant legal consequences, as detailed below, with respect to HVY's allegedly "foreign" investments and allegedly "foreign" corporate nationality under Articles 1(6) and 1(7) of the ECT.
668. Indeed, the Russian Oligarchs' continued ownership and control over HVY, and their abuse of HVY's shell form, is further confirmed by the fact that the Russian Oligarchs would reap the benefit of the Yukos Awards, if they were enforced. Because the Guernsey and Jersey trusts indirectly hold all of HVY's shares, the Russian Oligarchs, as beneficiaries of the trusts, ultimately would enjoy the proceeds of the Final Awards. One of the Russian Oligarchs, Mr. Leonid Nevzlin, has conceded as much on multiple occasions.¹⁰⁷⁷

"If [HVY] prevail, it would mean there would be additional input of money into GML, so the volume of financial resources in the trusts where I am a beneficiary would be larger. So perhaps my requests for the trustee would increase as a beneficiary."¹⁰⁷⁸

"Speaking from Israel, Nevzlin noted his Group Menatep Limited (GML), the holding company for Yukos' main owners in which Nevzlin has a 70-percent

¹⁰⁷⁴ See *supra* chapter III.B(d).

¹⁰⁷⁵ See *supra* chapter III.B(b).

¹⁰⁷⁶ See also § 648; Pleading Notes RF, § 47.

¹⁰⁷⁷ SoR, §§ 252-257.

¹⁰⁷⁸ English original: "*If Claimants prevail [HVY in the arbitrations], it would mean there would be additional input of money into GML, so the volume of financial resources in the trusts where I am a beneficiary would be larger. So perhaps my requests for the trustee would increase as a beneficiary.*" Nevzlin Testimony, Day 7, 206:1-4. [emphasis added]

stake, was seeking more than \$100 billion but 'it is impossible to say that we are not satisfied with the \$50 billion.'"¹⁰⁷⁹

669. Notwithstanding the fact that HVY have the burden of proving the protected status for them and their Yukos shares in accordance with Article 1(6) and (7) ECT, witness testimony and documentary evidence submitted by the Russian Federation establishes that the Russian Oligarchs have factual full control over the trustees and herewith over HVY.¹⁰⁸⁰

(b)(ii) *HVY Are Not "Investors" And Did Not Make "Investments" Within The Meaning Of The ECT Because The ECT Does Not Protect Round-Trip Investments By Host State Nationals Through Shell Companies*

670. It is a fundamental principle of international law that, as set forth under Article 31 of the VCLT, a "treaty shall be interpreted in good faith in accordance with the ordinary meaning to be given to the terms of the treaty in their context and in the light of its object and purpose."¹⁰⁸¹ Neither the text of the ECT read in proper context, nor the object and purpose of the ECT, supports the view that the Treaty protects mere shell companies established by Russian nationals outside of the Russian Federation in order to channel funds derived from their activities in the Russian Federation. HVY's claim to the contrary – *i.e.*, that the ECT merely imposes minimum requirements for a covered investor and investment¹⁰⁸² – relies on an overly formalistic, and incorrect, reading of the Treaty. As Professor Pellet observes, HVY's misinterpretation reflects an "extremely formal reasoning" that "clearly contradicts

¹⁰⁷⁹ English original: "Speaking from Israel, Nevzlin noted his Group Menatep Limited (GML), the holding company for Yukos' main owners in which Nevzlin has a 70-percent stake, was seeking more than \$100 billion but 'it is impossible to say that we are not satisfied with the \$50 billion.'" Radio Free Europe, *Former Yukos Official Satisfied With Court Award*, (Jul. 29, 2014) (Exhibit RF-67) [emphasis added]; Financial Times, *Leonid Nevzlin is biggest winner from Yukos ruling at The Hague*, (Jul. 28, 2014) (Exhibit RF-68) noting that "[f]or nearly a decade, 54 year-old Leonid Nevzlin has been at the centre of the legal fight for compensation for Yukos shareholders. On Monday his patience and persistence paid off. As the biggest shareholder of GML, the former Yukos holding company that brought the legal case, with a 70 per cent stake, Mr Nevzlin stands to be the biggest single beneficiary from The Hague's 50 \$bn award ruling"; Reuters, *Nevzlin 'very pleased' with Hague court ruling on Yukos*, (Jul. 28, 2014) (Exhibit RF-69): "Leonid Nevzlin, the biggest ultimate beneficial owner of defunct oil giant Yukos, expressed satisfaction with the Hague's arbitration court ruling that Russia must pay a group of shareholders around \$50 billion for expropriating its assets."

¹⁰⁸⁰ DoA, §§ 457-474.

¹⁰⁸¹ Article 31 VCLT. English original: "a treaty shall be interpreted in good faith in accordance with the ordinary meaning to be given to the terms of the treaty in their context and in the light of its object and purpose." See also Writ, §§ 256, 267; SoR, §§ 222, 234, 245.

¹⁰⁸² SoA, §§ 725, 730.

the very *raison d'être* of the ECT which is the protection of *foreign* investments.”¹⁰⁸³ Indeed, as set forth in the Writ,¹⁰⁸⁴ the Reply,¹⁰⁸⁵ and below, a correct contextual reading of the ECT, in light of its objective and purpose, confirms that the ECT does *not* protect such so-called “round-trip” investments.

(b)(ii)(i) *The Object And Purpose Of The ECT Is To Promote And Protect Investments By Investors From Other Contracting Parties, Not Round-Trip Investments By Host State Nationals*

671. The assessment of the text itself and underlying object and purpose of the ECT is the starting point for a proper understanding of the Treaty.¹⁰⁸⁶ Article 2 of the ECT (“Purpose of the Treaty”) states that “[t]his Treaty establishes a legal framework in order to promote long-term cooperation in the energy field, based on complementarities and mutual benefits, in accordance with the objectives and principles of the [European Energy] Charter.”¹⁰⁸⁷ The European Energy Charter likewise reinforces the “spirit of political and economic cooperation” among the signatory States, and includes among its stated objectives “to create a climate favourable to . . . the flow of investments and technologies.”¹⁰⁸⁸ The Charter also provides that, “[i]n order to promote the *international* flow of investments,” the signatory States would “provide for a stable, transparent legal framework for *foreign investments*, in conformity with the relevant international laws and rules on investments and trade.”¹⁰⁸⁹ The Final Act of the European Energy Charter Conference, to which the text

¹⁰⁸³ English original: "This is an extremely formal reasoning (...) and clearly contradicts the very *raison d'être* of the ECT which is the protection of *foreign* investments." (emphasis in original) See Expert Opinion of Prof. Pellet § 6 (**Exhibit RF-D16**).

¹⁰⁸⁴ See Writ, §§ 61-65, 248-276.

¹⁰⁸⁵ See SoR, §§ 220-273.

¹⁰⁸⁶ See Writ, §§ 61-65; SoR, §§ 227-229.

¹⁰⁸⁷ Article 2 ECT. English original: "[t]his Treaty establishes a legal framework in order to promote long-term cooperation in the energy field, based on complementarities and mutual benefits, in accordance with the objectives and principles of the [European Energy] Charter." See also Writ, §§ 61, 252; SoR, § 227.

¹⁰⁸⁸ English original: "spirit of political and economic cooperation (...) to create a climate favourable to (...) the flow of investments and technologies" European Energy Charter, Title I (Objectives); The Charter itself had its origins in a proposal from Prime Minister Ruud Lubbers of the Netherlands, who "proposed establishing a European Energy Community to capitalize on the complementary relationship between the European Economic Community, the USSR and the countries of Central and Eastern Europe." Communication from the EC Commission on European Energy Charter, COM(91) 36 dated 14 Feb. 1991, at 2. See also §§ 62, 252; SoR, § 227.

¹⁰⁸⁹ English original: "[i]n order to promote the international flow of investments (...) provide for a stable, transparent legal framework for foreign investments, in conformity with the relevant international laws and rules on investments and trade." European Energy Charter, Title II (Implementation) (emphasis added).

of the ECT was appended, states that the Treaty was “designed to promote East-West industrial co-operation by providing legal safeguards in areas such as investment, transit and trade.”¹⁰⁹⁰ Statements by the Energy Charter Secretariat further confirm the inherently transnational nature and purpose of the ECT – a “unique instrument for the promotion of *international* cooperation in the energy sector”¹⁰⁹¹ which “ensures the protection of *foreign energy investments*.”¹⁰⁹²

672. Indeed, it is hardly a controversial proposition that a multilateral treaty fostering inter-State cooperation on energy matters is intended to promote and protect investment by foreign, rather than host State, investors. As Professor Pellet observes, “[i]n this regard, the ECT is not different from other investment treaties. The very purpose of these treaties is to attract and protect *foreign* investors, not investment from a national source.”¹⁰⁹³ Nonetheless, HVY suggest that the ECT was intended simply to promote and protect the general “flow of investments,” which purportedly does not “exclude investment protection to entities owned or controlled by citizens or nationals from their own ECT State (the host State).”¹⁰⁹⁴ In this regard, Professor Pellet observes that “HVY, against any substantial reason, do not agree that the object and purpose of the ECT is to protect foreign investors.”¹⁰⁹⁵ In fact, HVY’s position does not even agree with the view they expressed at the District Court, where they conceded that the “object and purpose of the ECT is to promote cross-border investment and cross-border cooperation in the energy sector.”¹⁰⁹⁶ The arbitral Tribunal itself confirmed this same fundamental principle:

¹⁰⁹⁰ English original: “designed to promote East-West industrial co-operation by providing legal safeguards in areas such as investment, transit and trade.” Final Act of the European Energy Charter Conference, *adopted* in Lisbon on 17 Dec. 1994, at 5.

¹⁰⁹¹ English original: “unique instrument for the promotion of international cooperation in the energy sector” Foreword to the ECT by Secretary General Urban Rusnák dated 15 Jan. 1965 (emphasis added).

¹⁰⁹² English original: “ensures the protection of foreign energy investments.” Energy Charter Secretariat, *The Energy Charter Treaty and Related Documents: A Legal Framework for International Energy Cooperation, An Introduction to the Energy Charter Treaty*, at 14 (emphasis added).

¹⁰⁹³ English original: “[i]n this regard, the ECT is not different from other investment treaties. The very purpose of these treaties is to attract and protect *foreign* investors, not investment from a national source.” (emphasis in original) Expert Opinion of Prof. Pellet § 19 (**Exhibit RF-D16**). *See also id.* § 17 (“The object and purpose of the ECT is unequivocally clear and explicit.”).

¹⁰⁹⁴ SoA, § 736.

¹⁰⁹⁵ English original: “HVY, against any substantial reason, do not agree that the object and purpose of the ECT is to protect foreign investors.” *See* Expert Opinion of Prof. Pellet, § 14 (**Exhibit RF-D16**) (refuting SoA, § 736).

¹⁰⁹⁶ SoD, §I.57.

The Tribunal accepts that the ECT is directed towards the promotion of foreign investment, especially of investment by Western sources in the energy resources of the Russian Federation and other successor States of the USSR. The Treaty is meant, as specified in the Secretariat's Introduction, to ensure 'the protection of foreign energy investments.'¹⁰⁹⁷

673. The Tribunal further acknowledged that:

If the States that took part in the drafting of the ECT had been asked in the course of that process whether the ECT was designed to protect – and should be interpreted and applied to protect – investments in a Contracting State by nationals of that same Contracting State whose capital derived from the energy resources of that State, it may well be that the answer would have been in the negative¹⁰⁹⁸

674. In fact, as detailed below, the text of the ECT confirms that the Contracting Parties did consider, and rejected, the possibility that a mere shell company meeting only formalistic nationality requirements could benefit from the protections of the Treaty. In any event, the essentially undisputed object and purpose of the Treaty – *i.e.*, to promote and protect foreign, cross-border investment, in particular by Western investors in the former USSR – is entirely inconsistent with HVY's claim that the ECT extends protections to investments made by Russian nationals in Russia by way of shell entities. As the Treaty text further demonstrates, and as Professor Pellet explains, "the Parties to the ECT *have* agreed that the purpose of the Treaty was to promote and protect foreign investments."¹⁰⁹⁹

675. References herein to a "Contracting Party" or "Contracting Parties" reflect those terms as defined and used in the Treaty text. Article 1(2) of the ECT plainly states that a "Contracting Party" means a state or Regional Economic Integration Organisation which

¹⁰⁹⁷ English original: "(...) The Tribunal accepts that the ECT is directed towards the promotion of foreign investment, especially of investment by Western sources in the energy resources of the Russian Federation and other successor States of the USSR. The Treaty is meant, as specified in the Secretariat's Introduction, to ensure 'the protection of foreign energy investments. (...)." HEL Interim Award, § 433; YUL Interim Award, § 434; VPL Interim Award, § 490; *see also* Writ, § 253; Expert Opinion of Prof. Pellet on § 16 (**Exhibit RF-D16**) ("In fact, the Arbitral Tribunal, expressly recognized this object and purpose of the ECT but refused to give effect to it . . .").

¹⁰⁹⁸ English original: "(...) If the States that took part in the drafting of the ECT had been asked in the course of that process whether the ECT was designed to protect – and should be interpreted and applied to protect – investments in a Contracting State by nationals of that same Contracting State whose capital derived from the energy resources of that State, it may well be that the answer would have been in the negative (...)" HEL Interim Award, § 433; YUL Interim Award, § 434; VPL Interim Award, § 490; *see also* Writ, § 254.

¹⁰⁹⁹ English original: "the Parties to the ECT *have* agreed that the purpose of the Treaty was to promote and protect foreign investments." (emphasis in original) *See* Expert Opinion of Prof. Pellet § 62 (**Exhibit RF-D16**).

has consented to be bound by this Treaty and for which the Treaty is in force.”¹¹⁰⁰ To be clear, the Russian Federation reiterates that it was a negotiating party and a signatory to the ECT – but not a Contracting Party, as it never ratified the Treaty.¹¹⁰¹

(b)(ii)(ii) *The Ordinary Meaning Of The Treaty, In Full And Proper Context, Establishes That The ECT Protects Investments By Investors From Other Contracting Parties, Not Round-Trip Investments By Host State Nationals*

676. Articles 1(6) and 1(7) of the ECT set forth the definitions of “Investment” and “Investor,” respectively, under the Treaty. Article 1(6) provides, in part, that “Investment means every kind of asset, owned or controlled directly or indirectly by an Investor.”¹¹⁰² Article 1(7) provides, in part, that an “Investor” is “a company or other organization organised in accordance with the law applicable in that Contracting Party.”¹¹⁰³ HVY view these definitional provisions as dispositive. They argue sweepingly, without any supporting authority, that there are “two distinct types of international investment treaties (and thus two different systems)” – and that the ECT falls into the system that “merely require[s] that an investor be incorporated in an ECT State.”¹¹⁰⁴ The Tribunal took the same unduly formalistic view, ruling that HVY and the shares they held in Yukos are protected under the ECT solely because HVY are incorporated in Cyprus and the Isle of Man, and they nominally owned the Yukos shares at issue.¹¹⁰⁵ Under this incorrect interpretation, absent an express prohibition on round-trip investments, compliance with the bare – linguistic – requirements of Articles 1(6) and 1(7) purportedly is enough to permit a tribunal to exercise jurisdiction.¹¹⁰⁶
677. To the contrary, a proper understanding of Articles 1(6) and 1(7), and their application within the substantive and procedural provisions of the ECT, requires that they cannot be

¹¹⁰⁰ English original: Article 1(2) ECT: “Contracting Party’ means a state or Regional Economic Integration Organisation which has consented to be bound by this Treaty and for which the Treaty is in force.”

¹¹⁰¹ See Avtonomov, §§ 11-12 (**Exhibit RF-D14**); Article 39 ECT (“This Treaty shall be subject to ratification, acceptance or approval by signatories. Instruments of ratification, acceptance or approval shall be deposited with the Depository.”).

¹¹⁰² English original: “every kind of asset, owned or controlled directly or indirectly by an Investor.”

¹¹⁰³ English original: “a company or other organisation organised in accordance with the law applicable in that Contracting Party.”

¹¹⁰⁴ SoA, § 726.

¹¹⁰⁵ See, e.g., HEL Interim Award, §§ 411-417; YUL Interim Award, §§ 411-417; VPL Interim Award, §§ 411-417; see also Writ, §§ 255-256.

¹¹⁰⁶ See SoA, §§ 725-726.

read in isolation.¹¹⁰⁷ Indeed, there is no treaty “system” driven solely by the definitional provisions of Article 1. Rather, well-established international legal authority confirms the necessity of a full contextual reading, as memorialized in Article 31 of the VCLT.¹¹⁰⁸ The ICJ, for example, has long held that it follows a “natural and reasonable way of reading the [treaty] text,” rather than a “purely grammatical interpretation of the text.”¹¹⁰⁹ Tribunals interpreting the ECT, in particular, also have cautioned against a superficial reading. In the recent decision in *Cem Cengiz Uzan v. Turkey*, the tribunal held that “a simple dictionary reading of the terms in a treaty is not what is called for.”¹¹¹⁰ Rather, the tribunal explained, it is “obligated” through an examination of the “entirety of the text read together” to “seek to give meaning to the wording of the ECT as drafted, beyond what could possibly be garnered from an overly grammatical reading of the relevant provisions.”¹¹¹¹ Professor Pellet confirms that “a word or a phrase in a sentence cannot be isolated from its context on the one hand, nor can the object and purpose of the treaty be overlooked.”¹¹¹² In this instance, the meaning of the ECT is clear from the Treaty text read in its entirety, as fully amplified below.

678. A multitude of ECT provisions lend necessary textual context for a full and proper understanding of the meaning of “Investor” and “Investment” under the Treaty – beginning with Article 26, the dispute settlement provision that provides the jurisdictional predicate for a tribunal to adjudicate claims under the Treaty. As the *Cem Cengiz Uzan* tribunal

¹¹⁰⁷ See, e.g., Expert Opinion of Prof. Pellet §§ 6-7 (**Exhibit RF-D16**) (concluding that HVY erroneously “retain the same interpretation of Article 1 (7) envisaged in isolation” as the Tribunal had through its “extremely formal reasoning which does not comply with the ‘General rule of interpretation’ contained in article 31 VCL”).

¹¹⁰⁸ Writ, §§ 256, 267; SoR, §§ 222, 234, 245.

¹¹⁰⁹ English original: “natural and reasonable way of reading the [treaty] text [rather than a] purely grammatical interpretation of the text” *Anglo-Iranian Oil Co. (United Kingdom v. Iran)*, ICJ REPORTS 1952 (Judgment of 22 July 1952), at 104 (**Exhibit RF-338**); see also Expert Opinion of Prof. Pellet § 8 (**Exhibit RF-D16**): “To paraphrase the ICJ in the Anglo-Iranian case, the Tribunal “cannot base itself on a purely grammatical interpretation of the text. It must seek the interpretation which is in harmony with a natural and reasonable way of reading the text.”

¹¹¹⁰ English original: “a simple dictionary reading of the terms in a treaty is not what is called for.” *Cem Cengiz Uzan v. Republic of Turkey*, SCC Case No. V 2014/023, Award on Respondent’s Bifurcated Preliminary Objection dated 20 Apr. 2016, § 137 (**Exhibit RF-339**).

¹¹¹¹ *Id.* § 137. English original: “obligated (...) entirety of the text read together (...) seek to give meaning to the wording of the ECT as drafted, beyond what could possibly be garnered from an overly grammatical reading of the relevant provisions.”

¹¹¹² English original: “a word or a phrase in a sentence cannot be isolated from its context on the one hand, nor can the object and purpose of the treaty be overlooked.” Expert Opinion of Prof. Pellet § 10 (**Exhibit RF-D16**).

recognized, “in order to establish jurisdiction, the most relevant Article of the ECT is Article 26. Therefore, the Tribunal must investigate whether the Claimant is an Investor within the meaning of Article 26 of the ECT.”¹¹¹³ Article 26(1) limits a tribunal’s jurisdiction to “Disputes between a Contracting Party and *an Investor of another Contracting Party* relating to an Investment of the latter in the Area of the former, which concern an alleged breach of an obligation of the former under Part III.”¹¹¹⁴ Thus, the very provision of the Treaty which articulates the scope of arbitrable disputes under the ECT requires, with specificity, that only “an Investor of another Contracting Party” may bring claims a signatory State. As the *Cem Cengiz Uzan* tribunal noted, “the use of the word ‘another’ is what essentially makes an Investor an international investor. Furthermore, the words ‘of the latter in the Area of the former’ appears to place an emphasis on the Investor being imbued with a transnational quality – that is to say an Investor who is engaged in some form of cross-border transaction.”¹¹¹⁵

679. Indeed, the ECT is replete with references in other provisions to “Investors of *another Contracting Party*” and “Investments in the Area of another Contracting Party” – thus underscoring that the Treaty is intended to cover only the investments of foreign nationals, and not nationals of the host State who channel their investments through shell companies:¹¹¹⁶

- Article 10 (Promotion, Protection and Treatment of Investments): “Each Contracting Party shall . . . encourage and create stable, equitable, favourable and transparent

¹¹¹³ English original: “in order to establish jurisdiction, the most relevant article of the ECT is Article 26 (...) Therefore, the Tribunal must investigate whether the Claimant is an Investor within the meaning of Article 26 of the ECT.” *Cem Cengiz Uzan v. Republic of Turkey*, SCC Case No. V 2014/023, Award on Respondent’s Bifurcated Preliminary Objection dated 20 April 2016, § 145. See also § 129 (noting that “Part (1) of Article 26 defines the disputes which are capable of settlement in accordance with the following sections of Article 26”).

¹¹¹⁴ Article 26(1) ECT. English original: “Disputes between a Contracting Party and an Investor of another Contracting Party relating to an Investment of the latter in the Area of the former, which concern an alleged breach of an obligation of the former under Part III.” (emphasis added).

¹¹¹⁵ English original: “the use of the word ‘another’ is what essentially makes an Investor an international investor. Furthermore, the words ‘of the latter in the Area of the former’ appears to place an emphasis on the Investor being imbued with a transnational quality – that is to say an Investor who is engaged in some form of cross-border transaction.” *Cem Cengiz Uzan v. Republic of Turkey*, SCC Case No. V 2014/023, Award on Respondent’s Bifurcated Preliminary Objection dated 20 April 2016, § 146 (**Exhibit RF-339**).

¹¹¹⁶ See Expert Opinion of Prof. Pellet on § 11 (**Exhibit RF-D16**) (noting that, “[a]s to the context in which Article 1(7) must be read, it must be noted that the ECT repeatedly refers to the ‘Investors of *another Contracting Party*’,” and enumerating such provisions) (emphasis in original).

UNOFFICIAL TRANSLATION

This text is an unofficial translation of the Dutch original. In case of any discrepancies, the Dutch original shall prevail.

conditions for *Investors of other Contracting Parties*,” and accord “to *Investors of other Contracting Parties* . . . [treatment] no less favourable”¹¹¹⁷

- Article 11 (Key Personnel): “A Contracting Party shall . . . examine in good faith requests by *Investors of another Contracting Party* . . . to enter and remain temporarily in its Area,” and “shall permit *Investors of another Contracting Party* . . . to employ any key person”¹¹¹⁸
- Article 12 (Compensation for Losses): “[A]n Investor of any Contracting Party who suffers a loss with respect to any *Investment in the Area of another Contracting Party* . . . shall be accorded by the latter Contracting Party . . . treatment which is the most favourable . . .” and “an Investor of a Contracting Party which . . . suffers a loss *in the Area of another Contracting Party* resulting from . . . shall be accorded restitution”¹¹¹⁹
- Article 13 (Expropriation): “*Investments* of Investors of a Contracting Party *in the Area of any other Contracting Party* shall not be nationalised, expropriated”¹¹²⁰
- Article 14 (Transfers Related to Investments): “Each Contracting Party shall with respect to Investments in its Area of *Investors of any other Contracting Party* guarantee the freedom of transfer”¹¹²¹
- Article 15 (Subrogation): “If a Contracting Party . . . makes a payment under an indemnity or guarantee given in respect of an *Investment* of an Investor . . . *in the Area of another Contracting Party*”¹¹²²
- Article 24 (Exceptions): “The provisions of this Treaty which accord [MFN] treatment shall not oblige any Contracting Party to extend to the *Investors of any other Contracting Party* any preferential treatment”¹¹²³

¹¹¹⁷ English original: Article 10 (Promotion, Protection and Treatment of Investments): “Each Contracting Party shall (...) encourage and create stable, equitable, favourable and transparent conditions for *Investors of other Contracting Parties*,” and accord “to *Investors of other Contracting Parties* (...) [treatment] no less favourable (...).”

¹¹¹⁸ English original: Article 11 (Key Personnel): “A Contracting Party shall (...) examine in good faith requests by *Investors of another Contracting Party* (...) to enter and remain temporarily in its Area,” and “shall permit *Investors of another Contracting Party* (...) to employ any key person (...).”

¹¹¹⁹ English original: Article 12 (Compensation for Losses): “[A]n Investor of any Contracting Party who suffers a loss with respect to any *Investment in the Area of another Contracting Party* (...) shall be accorded by the latter Contracting Party (...) treatment which is the most favourable (...)” and “an Investor of a Contracting Party which (...) suffers a loss in the Area of another Contracting Party resulting from (...) shall be accorded restitution (...).”

¹¹²⁰ English original: Article 13 (Expropriation): “*Investments* of Investors of a Contracting Party in the Area of any other Contracting Party shall not be nationalised, expropriated (...).”

¹¹²¹ English original: Article 14 (Transfers Related to Investments): “Each Contracting Party shall with respect to Investments in its Area of *Investors of any other Contracting Party* guarantee the freedom of transfer (...).”

¹¹²² English original: Article 15 (Subrogation): “If a Contracting Party (...) makes a payment under an indemnity or guarantee given in respect of an *Investment* of an Investor (...) in the Area of another Contracting Party (...).”

- Article 45 (Provisional Application): “In the event that a signatory terminates provisional application under [Art. 45(3)(a)], the obligation of the signatory under [Art. 45(1)] to apply Parts III and V with respect to any Investments made in its Area during such provisional application *by Investors of other signatories . . .*”¹¹²⁴
- Article 47 (Withdrawal): “The provisions of this Treaty shall continue to apply to Investments made in the Area of a Contracting Party *by Investors of other Contracting Parties* or in the Area of other Contracting Parties by Investors of that Contracting Party”¹¹²⁵

680. Article 17 of the ECT provides further important context for a proper understanding of the scope of “Investment” and “Investor” under Articles 1(6) and 1(7). Article 17 provides, in relevant part, that “[e]ach Contracting Party reserves the right to deny the advantages of this Part to: (1) a legal entity if citizens or nationals of a *third* state own or control such entity and if that entity has no substantial business activities in the Area of the Contracting Party in which it is organized”¹¹²⁶ This is the so-called “A-B-C” scheme (where State A is the host State, State B is the State of incorporation, and State C is the State of the entity owning or controlling the company in State B). Article 17 expressly carves out investors from non-Contracting Parties who purport to meet the ECT investor requirements by routing their investment through a shell entity incorporated in a Contracting Party.

681. This provision makes clear that the ECT Contracting Parties intended to have the possibility to exclude shell entities that might otherwise, in a formalistic sense, meet the Article 1 definition. If investments controlled by *third*-State nationals were thus considered unworthy of protection under the ECT, then, *a fortiori*, investments controlled by nationals of the host State also must be outside of the scope of the ECT’s protection. This latter scenario is the so-called “A-B-A” scheme (where State A is again the host State, State B is again the State of incorporation, but State A – the same as the host State – is now also the

¹¹²³ English original: Article 24 (Exceptions): “The provisions of this Treaty which accord most favoured nation treatment shall not oblige any Contracting Party to extend to the Investors of any other Contracting Party any preferential treatment (...)”.

¹¹²⁴ English original: Article 45 (Provisional Application): “In the event that a signatory terminates provisional application under [Art. 45(3)(a)], the obligation of the signatory under [Art. 45(1)] to apply Parts III and V with respect to any Investments made in its Area during such provisional application by Investors of other signatories (...)”.

¹¹²⁵ English original: Article 47 (Withdrawal): “The provisions of this Treaty shall continue to apply to Investments made in the Area of a Contracting Party by Investors of other Contracting Parties or in the Area of other Contracting Parties by Investors of that Contracting Party (...)”.

¹¹²⁶ English original: Article 17(1): “[e]ach Contracting Party reserves the right to deny the advantages of this Part to: (1) a legal entity if citizens or nationals of a third state own or control such entity and if that entity has no substantial business activities in the Area of the Contracting Party in which it is organized.”.

State of the entity owning or controlling the company in State B; *i.e.*, the host State's own nationals own or control the investment). To allow otherwise would permit a round-trip (or A-B-A) investor to circumvent the object and purpose of the Treaty – to foster investment between, not within, States – by founding a shell entity with no substantial business activities in another Contracting State.

682. HVY argue that the Russian Federation has not challenged the Tribunal's ruling with respect to Article 17, and thus claim "that is the end of the matter, then, as far as this point is concerned."¹¹²⁷ In fact, in the arbitration, the Russian Federation argued – as a separate ground for dismissal – that HVY's claims were inadmissible because Article 17 operates to preclude application of the Treaty's substantive protections to parties like HVY.¹¹²⁸ The Tribunal, accordingly, decided the Article 17 defense as an issue of admissibility, not jurisdiction.¹¹²⁹ In this proceeding, the Russian Federation has not relied on Article 17 as an independent basis for set-aside – but, rather, as critical textual context that informs the jurisdictional inquiry of whether HVY are "Investors" that made "Investments" and permitted to access the dispute settlement procedures under Article 26. As discussed immediately above and in the pleadings below,¹¹³⁰ Article 17 is one of many ECT provisions reinforcing that the Treaty does not protect round-trip investments of the sort made by HVY.
683. The Understandings adopted by the ECT signatory States, which are included in the Final Act of the European Energy Charter Conference¹¹³¹ (to which the ECT itself was attached as Annex 1), provide further helpful context for a proper understanding of "Investor" and "Investment." The Final Act states that the representatives "agreed to adopt the following

¹¹²⁷ SoA, § 732.

¹¹²⁸ See, e.g., HEL Interim Award, § 71, sub-paragraphs 50-52 (summarizing the Russian Federation's arguments under the heading, "*The Claims are Inadmissible Because Part III of the Treaty Does Not Confer Rights on Claimants*"); YUL Interim Award, § 71, sub-paragraphs 50-52 (same); VPL Interim Award, § 71, sub-paragraphs 50-52 (same).

¹¹²⁹ See HEL Interim Award, §§ 440, 442 ("Whether or not Claimant is entitled to the advantages of Part III is a question not of jurisdiction but of the merits. Since Article 17 relates not to the ECT as a whole, or to Part V, but exclusively to Part III, its interpretation for that reason cannot determine whether the Tribunal has jurisdiction to entertain the claims of Claimant. . . . At the same time, the Tribunal takes note of the fact that the Parties have treated the application of Article 17 as a question of admissibility, not jurisdiction . . ."); YUL Interim Award, §§ 441, 443 (same); VPL Interim Award, §§ 497, 499 (same).

¹¹³⁰ See Writ, § 264; SoR, § 233; Pleading Notes RF, § 37.

¹¹³¹ Final Act of the European Energy Charter Conference, *adopted* in Lisbon on 17 Dec. 1994, at 6. To which the ECT itself was attached as Annex 1.

Understandings with respect to the Treaty.”¹¹³² As Professor Pellet notes, “[s]uch a practice is far from unusual”; further, the Understandings “are introduced by a formula which seems to have been very directly inspired by that of Article 31(2)(a) of the VCLT.”¹¹³³ Article 31(2)(a) provides that relevant “context for the purpose of the interpretation of a treaty” also includes “[a]ny agreement relating to the treaty which was made between all the parties in connection with the conclusion of the treaty.”¹¹³⁴ The Understanding with respect to Article 1(6) of the ECT is particularly illustrative. That Understanding provides, in part, that:

*For greater clarity as to whether an Investment made in the Area of one Contracting Party is controlled, directly or indirectly, by an Investor of any other Contracting Party, control of an Investment means control in fact, determined after an examination of the actual circumstances in each situation. In any such examination, all relevant factors should be considered Where there is doubt as to whether an Investor controls, directly or indirectly, an Investment, an Investor claiming such control has the burden of proof that such control exists.*¹¹³⁵

684. Once again, as throughout the ECT, the Understanding to Article 1(6) reinforces the interpretation that the Treaty covers investments made by “an Investor of any other Contracting Party” – and not investors of the host State. Moreover, as Professor Pellet explains, the Understanding leaves “no doubt that it was the Parties’ intention to interpret the Treaty they had just adopted,” and demonstrates that “the Drafters of the Treaty were determined not to retain a formal approach but to ensure the reality of the control exercised by the ‘Investor of any other Contracting Party.’”¹¹³⁶ Together, this Understanding and the

¹¹³² English original: “agreed to adopt the following Understandings with respect to the Treaty.” Final Act of the European Energy Charter Conference.

¹¹³³ English original: “[s]uch a practice is far from unusual”; further, the Understandings “are introduced by a formula which seems to have been very directly inspired by that of Article 31(2)(a) of the VCLT.” Expert Opinion of Prof. Pellet §§ 46-47 (**Exhibit RF-D16**).

¹¹³⁴ English original: Article 31(2): “context for the purpose of the interpretation of a treaty [also includes] [a]ny agreement relating to the treaty which was made between all the parties in connexion with the conclusion of the treaty.”

¹¹³⁵ English original: “For greater clarity as to whether an Investment made in the Area of one Contracting Party is controlled, directly or indirectly, by an Investor of any other Contracting Party, control of an Investment means control in fact, determined after an examination of the actual circumstances in each situation. In any such examination, all relevant factors should be considered (...). Where there is doubt as to whether an Investor controls, directly or indirectly, an Investment, an Investor claiming such control has the burden of proof that such control exists.” Final Act (Understanding IV.3 at article 1(6) ECT). See also Pleading Notes RF, § 37.

¹¹³⁶ English original: “Concerning Understanding 3, there is no doubt that it was the Parties’ intention to interpret the Treaty they had just adopted (...) It also results from this wording that the Drafters of the

numerous other referenced Treaty provisions provide full context, and reaffirm that the Treaty promotes and protects actual cross-border investment by foreign investors¹¹³⁷ – and not “round-trip” investments by nationals of the host State through shell entities which, at most, purport to meet only a formalistic definition of investor and investment.

(b)(ii)(iii) *International Law Principles Confirm That The ECT Protects Investments By Investors From Other Contracting Parties, Not Round-Trip Investments By Host State Nationals*

685. As a matter of treaty interpretation, Article 31(3) of the VCLT further provides that “[t]here shall be taken into account, together with the context . . . (c) [a]ny relevant rules of international law applicable in the relations between the parties.”¹¹³⁸ The ECT itself provides, in Article 26(6), that “[a] tribunal established under paragraph (4) shall decide the issues in dispute in accordance with this Treaty *and applicable rules and principles of international law*.”¹¹³⁹ Together with the context provided within the ECT itself, well-established principles of international law confirm that the Treaty does not protect round-trip investments by host State nationals.
686. First, as Professor Pellet explains, one of the fundamental principles of international law is that “investment law aims at protecting *international* investments and not *domestic* investments.”¹¹⁴⁰ Arbitral tribunals and national courts widely agree that the investment

Treaty were determined not to retain a formal approach but to ensure the reality of the control exercised by the 'Investor of any *other* Contracting Party.' Expert Opinion of Prof. Pellet §§ 49-50 (**Exhibit RF-D16**). See also *id.* § 44 ("This interpretation of Article 1(6) ECT given by the Parties themselves is of great significance.").

¹¹³⁷ See Expert Opinion of Prof. Pellet § 12 (**Exhibit RF-D16**) ("This long litany is telling: the drafters of the ECT intended to regulate and protect the investments made in the Area of a Contracting Party by an investor of *another* Contracting Party.") (emphasis in original). See also *id.* § 29 ("Examined in its context and in the light of its object and purpose, it is clear that the fact that the ECT refers in its definition to just an investor without specifying 'foreign' does not mean that any investor is entitled to the protection offered by the ECT.").

¹¹³⁸ English original: Article 31(3)(c): "[t]here shall be taken into account, together with the context (...) [a]ny relevant rules of international law applicable in the relations between the parties." See also Writ, §§ 267-272; SoR, §§ 235-236.

¹¹³⁹ English original: Article 26(6): "[a] tribunal established under paragraph (4) shall decide the issues in dispute in accordance with this Treaty and applicable rules and principles of international law (...) pertinent customary international law". Expert Opinion of Prof. Pellet § 29 (**Exhibit RF-D16**) (quoting *Ioannis Kardassopoulos v. Georgia*, ICSID Case No. ARB/05/18, Decision on Jurisdiction dated 6 July 2007 § 208 n. 318).

¹¹⁴⁰ English original: "investment law aims at protecting *international* investments and not *domestic* investments." Expert Opinion of Prof. Pellet § 30 (emphasis in original). See also *id.* § 19 ("The very purpose of these treaties is to attract and protect *foreign* investors, not investment from a national source.") (emphasis in original).

treaty regime is not intended to provide domestic investors with recourse against their home States with respect to investments made at home. Thus, for example, the tribunal in *Lemire v. Ukraine* held that, “[w]hen agreeing to [investment treaties], States confer rights to foreign investors, which are unavailable to their own citizens The different treatment between foreign and domestic investors is a natural consequence of a [treaty].”¹¹⁴¹ The tribunal in *Phoenix Action v. Czech Republic* similarly held that “BITs are signed to foster the flow of international investments The BITs are not deemed to create a protection for rights involved in purely domestic claims, not involving any significant flow of capital, resources or activity into the host State’s economy.”¹¹⁴²

687. Numerous other tribunals have affirmed this basic principle.¹¹⁴³

688. A second governing principle of international law is that, where there exists a division between a formal or legal owner, on the one hand, and a beneficial or substantive owner on the other, international law grants standing only to the latter. As the *ad hoc* annulment committee in *Occidental v. Ecuador* explained:

[I]nternational law authorities have agreed that the real and equitable owner of an international claim is the proper party before an international adjudication *The notion that the beneficial (and not the nominal) owner of property is the real party-in-interest before an international court may be justly considered a general principle of international law.* . . . The position as regards beneficial ownership is a reflection of a more general principle of international investment law: claimants are only permitted to submit their own claims, held for their own benefit, not those held (be it as nominees, agents or otherwise) on behalf of third parties not protected by the relevant treaty. And tribunals exceed their jurisdiction if they grant compensation to third parties

¹¹⁴¹ English original: “[w]hen agreeing to [investment treaties], States confer rights to foreign investors, which are unavailable to their own citizens. (...) The different treatment between foreign and domestic investors is a natural consequence of a [treaty].” *Lemire v. Ukraine*, ICSID Case No. ARB/06/18, Award dated 28 March 2011 §§ 56-57 (**Exhibit RF-340**).

¹¹⁴² English original: “BITs are signed to foster the flow of international investments (...) The BITs are not deemed to create a protection for rights involved in purely domestic claims, not involving any significant flow of capital, resources or activity into the host State’s economy.” *Phoenix Action, Ltd. v. The Czech Republic*, ICSID Case No. ARB/06/5, Award dated 15 Apr. 2009 § 97 (RME-1078). *See also* Writ, § 269; SoR, § 237.

¹¹⁴³ *See, e.g., The Loewen Group, Inc. and Raymond L. Loewen v. United States of America*, ICSID Case No. ARB(AF)/98/3, Award dated 26 June 2003 §§ 222-224 (R-217) (holding that NAFTA “was not intended to and could not affect the rights of American investors in relation to practices of the United States that adversely affect such American investors”); *ST-AD GmbH (Germany) v. The Republic of Bulgaria*, UNCITRAL, PCA Case No. 2011-06 (ST-BG), Award on Jurisdiction dated 18 July 2013 § 408 (**Exhibit RF-72**) (“[A] national of a State, whether a natural or a legal person, cannot, in principle, sue its own State in an international arbitration”). *See also* Writ, §§ 270-271; SoR, §§ 238-239.

whose investments are not entitled to protection under the relevant instrument.¹¹⁴⁴

689. Various other international tribunals have recognized and affirmed this principle. For example, in *Saghi v. Iran*, the Iran-U.S. Claims Tribunal set out in detail that its jurisprudence “has favored beneficial over nominal ownership of property.”¹¹⁴⁵ In *Loewen v. United States*, the tribunal denied a NAFTA claim because “[a]ll of the benefits of any award would clearly inure to the American corporation,” a national of the respondent State, rather than the Canadian shell company to which the claim had been assigned.¹¹⁴⁶ The tribunal refused “[t]o look at form rather than substances to resolve a complicated claim under an international treaty.”¹¹⁴⁷ In *Mihaly v. Sri Lanka*, the tribunal rejected a claim by a U.S. claimant on behalf of its Canadian partner because Canada was not a party to the ICSID Convention, and “[t]o allow such an assignment to operate in favor of Mihaly (Canada) would defeat the object and purpose of the ICSID Convention and the sanctity of the privity of international agreements not intended to create rights and obligations for non-Parties.”¹¹⁴⁸

¹¹⁴⁴ English original: “[I]nternational law authorities have agreed that the real and equitable owner of an international claim is the proper party before an international adjudication (...). *The notion that the beneficial (and not the nominal) owner of property is the real party-in-interest before an international court may be justly considered a general principle of international law(...)*. The position as regards beneficial ownership is a reflection of a more general principle of international investment law: claimants are only permitted to submit their own claims, held for their own benefit, not those held (be it as nominees, agents or otherwise) on behalf of third parties not protected by the relevant treaty. And tribunals exceed their jurisdiction if they grant compensation to third parties whose investments are not entitled to protection under the relevant instrument.” (emphasis in original) (internal quotations and citations omitted) *Occidental Petroleum Corporation et al. v. The Republic of Ecuador*, ICSID Case No. ARB/06/11, Decision on Annulment of the Award dated 2 Nov. 2015 §§ 260, 262 (**Exhibit RF-219**).

¹¹⁴⁵ English original: “has favored beneficial over nominal ownership of property”, *James M. Saghi et al. v. The Islamic Republic of Iran*, Iran – United States Claims Tribunal Award No. 544-298-2 dated 22 Jan. 1993 §§ 18-23 (R-227). See also *Binder-Haas Claim*, dated 26 Nov. 1954, at 4 (R-198) (ruling that a U.S. national claimant could not submit a claim as a “constructive trustee” for four beneficiaries, including one non-U.S. national; rather, only real or beneficiary owners could recover their damages).

¹¹⁴⁶ English original: “[a]ll of the benefits of any award would clearly inure to the American corporation”, *The Loewen Group, Inc. and Raymond L. Loewen v. United States of America*, ICSID Case No. ARB(AF)/98/3, Award dated 26 June 2003 § 237 (R-217).

¹¹⁴⁷ English original: “[t]o look at form rather than substances to resolve a complicated claim under an international treaty.” in *The Loewen Group, Inc. and Raymond L. Loewen v. United States of America*, ICSID Case No. ARB(AF)/98/3, Award dated 26 June 2003 § 237 (R-217).

¹¹⁴⁸ English original: “[t]o allow such an assignment to operate in favor of Mihaly (Canada) would defeat the object and purpose of the ICSID Convention and the sanctity of the privity of international agreements not intended to create rights and obligations for non-Parties.” in *Mihaly International Corporation v. Democratic Socialist Republic of Sri Lanka*, ICSID Case No. ARB/00/2, Award dated 15 Mar. 2002, § 24 (**Exhibit RF-341**).

690. Further to these two fundamental principles – *i.e.*, international law protects international (not domestic) investments, and grants standing to beneficial (not nominal) owners – tribunals in a number of cases have denied claims where the investment is, at bottom, owned or controlled by a national of the host State. In *Alapli v. Turkey*, for example, the tribunal denied claims for lack of jurisdiction under the ECT and the Netherlands-Turkey BIT, notwithstanding the fact that the claims nominally had been brought by a company incorporated in the Netherlands. The tribunal began its analysis by holding that merely meeting the formalistic definition of “investor” under the ECT was not enough to extend Treaty protections:

In signing the Netherlands-Turkey BIT and the ECT, Turkey could not have expected that treaty benefits would extend to just any Dutch company, regardless of its relationship to a Turkish investment. Nor could Turkey have expected that benefits would accrue to enterprises from the United States. Rather, Turkey agreed to arbitrate with Dutch entities that had actually made investments in Turkey. That jurisdictional principle must serve as the foundation in construing the notions of “investor” and “investment” in both Treaties, as well as the analogous provisions in the ICSID Convention.¹¹⁴⁹

691. The majority of the *Alapli* tribunal split as to the particular facts warranting dismissal. One arbitrator found dispositive the fact that the claimant entity had played a passive role and made no actual contribution: “[t]o be an investor a person must actually make an investment, in the sense of an active contribution. *Status as a national of the other contracting state is not in itself enough.* . . . To the extent that contributions were made, they came from nationals or companies of the United States and Turkey.”¹¹⁵⁰ The second arbitrator was more persuaded by the fact that “the introduction of the Dutch company

¹¹⁴⁹ English original: “In signing the Netherlands-Turkey BIT and the ECT, Turkey could not have expected that treaty benefits would extend to just any Dutch company, regardless of its relationship to a Turkish investment. Nor could Turkey have expected that benefits would accrue to enterprises from the United States. Rather, Turkey agreed to arbitrate with Dutch entities that had actually made investments in Turkey. That jurisdictional principle must serve as the foundation in construing the notions of “investor” and “investment” in both Treaties, as well as the analogous provisions in the ICSID Convention.” in *Alapli Elektrik B.V. v. Republic of Turkey*, ICSID Case No. ARB/08/13, Award dated 16 July 2012 §§ 335-336 (**Exhibit RF-139**); *see also id.* § 334 (“In examining the Treaties’ object and purpose, the Tribunal has been mindful of competing concerns. On the one hand, a conscientious arbitrator will not set jurisdictional barriers at unreasonable levels which deny investors’ legitimate expectations. *Neither, however, should a tribunal facilitate use of treaties by persons not intended to receive their benefits.*”) (emphasis added); *see also* SoR, §§ 234, 243.

¹¹⁵⁰ (emphasis added). English original: “[t]o be an investor a person must actually make an investment, in the sense of an active contribution. (...) *Status as a national of the other contracting state is not in itself enough* (...) To the extent that contributions were made, they came from nationals or companies of the United States and Turkey.” in *Alapli Elektrik B.V. v. Republic of Turkey*, ICSID Case No. ARB/08/13, Award dated 16 July 2012, §§ 350-351 (**Exhibit RF-139**).

[claimant] in the investment chain was, at the time it was performed, an abuse of the system of international investment protection under the ICSID/BIT/ECT mechanism.”¹¹⁵¹ In particular, “the introduction of the Dutch company had as its main purpose the access to international arbitration which did not exist for the Turkish nationals and the Turkish company.”¹¹⁵² Although the arbitrators approached the decision from different angles, the ultimate conclusion was the same: a Dutch claimant was not entitled to the protections of the ECT because it had been injected into the investment chain by host State (and third-State) nationals that exercised true ownership and control.

692. Other international tribunals have reached similar conclusions. For example, in *Venoklim v. Venezuela*, the tribunal dismissed the claim for lack of jurisdiction because “[p]retending that an investment made by Venoklim should be considered as a foreign investment only because this company is incorporated in the Netherlands, even though the investment that is the object of the dispute is in the end the property of Venezuelan legal entities, would allow formalism to prevail over reality and betray the object and purpose of the ICSID Convention.”¹¹⁵³ In *TSA Spectrum v. Argentina*, the tribunal likewise rejected a formalistic approach: “such a strict literal interpretation may appear to go against common sense in some circumstances, especially when the formal nationality covers a corporate entity controlled directly or indirectly by persons of the same nationality as the host State.”¹¹⁵⁴

¹¹⁵¹ English original: “the introduction of the Dutch company [claimant] in the investment chain was, at the time it was performed, an abuse of the system of international investment protection under the ICSID/BIT/ECT mechanism.” in *Alapli Elektrik B.V. v. Republic of Turkey*, ICSID Case No. ARB/08/13, Award dated 16 July 2012, § 390 (**Exhibit RF-139**).

¹¹⁵² English original: “the introduction of the Dutch company had as its main purpose the access to international arbitration which did not exist for the Turkish nationals and the Turkish company.” in *Alapli Elektrik B.V. v. Republic of Turkey*, ICSID Case No. ARB/08/13, Award dated 16 July 2012, § 393 (**Exhibit RF-139**).

¹¹⁵³ English original: “[p]retending that an investment made by Venoklim should be considered as a foreign investment only because this company is incorporated in the Netherlands, even though the investment that is the object of the dispute is in the end the property of Venezuelan legal entities, would allow formalism to prevail over reality and betray the object and purpose of the ICSID Convention.” in *Venoklim Holdings B.V. v. Bolivarian Republic of Venezuela*, ICSID Case No. ARB/12/22, Award dated 3 Apr. 2015, § 156 (**Exhibit RF-145**) (unofficial translation by counsel); *see also* SoR, § 241.

¹¹⁵⁴ English original: “such a strict literal interpretation may appear to go against common sense in some circumstances, especially when the formal nationality covers a corporate entity controlled directly or indirectly by persons of the same nationality as the host State.” in *TSA Spectrum de Argentina S.A. v. Argentine Republic*, ICSID Case No. ARB/05/5, Award dated 19 Dec. 2008, §§ 144-146 (**Exhibit RF-74**); *see also, e.g., National Gas S.A.E. v. Arab Republic of Egypt*, ICSID Case No. ARB/11/7, Award dated 3 Apr. 2014, § 136 (dismissing for lack of jurisdiction and recognizing that “there is a significant difference . . . between (i) control exercised by a national of the Contracting State against which the Claimant asserts its claim and (ii) control by a national of another Contracting State. The latter situation violates no principle of international law . . .”) (**Exhibit RF-73**); *Tokios Tokelès v. Ukraine*, ICSID Case

The tribunal dismissed the claims for lack of jurisdiction because, although the claimant was directly and wholly owned by a Dutch entity, the claimant's "ultimate owner" was a host State national.¹¹⁵⁵

693. HVY, nonetheless, rely on two ECT cases in which the tribunals adhered to a formalistic assessment of the nominal claimants which the respondents argued were mere shell entities.¹¹⁵⁶ Those decisions run contrary to the established international law principles articulated immediately above – and, in any event, are readily distinguishable from the case at hand. In one case, *RREEF v. Spain*, the respondent argued generally that a shell entity with only an indirect holding in a chain of ownership could not constitute an investor under the ECT; the case did not even involve a question of roundtrip investing by a national of the host State.¹¹⁵⁷ Professor Pellet, who served as the president of the tribunal, thus observes that "*the passage cited (but conspicuously not quoted) by HVY . . . bears upon indirect investment and shell companies and says strictly nothing about the nationality of the investor.*"¹¹⁵⁸
694. In the other case, *Charanne v. Spain*, the tribunal declined to look to the nationality of the ultimate owners of the shell claimants, and expressly "share[d] the position taken under the ECT by the tribunal in the Yukos case."¹¹⁵⁹ As Professor Pellet concludes, the flawed *Charanne* decision thus "calls for the same criticisms" as the Tribunal's decision in this

No. ARB/02/18, Decision on Jurisdiction, Dissenting Opinion of Prof. Weil dated 29 Apr. 2004, §§ 27-30 (Annex (Merits) C 1525) ("The ICSID mechanism and remedy are not meant for, and are not to be construed as, allowing – and even less encourage – nationals of a State party to the ICSID Convention to use a foreign corporation, whether preexistent or created for that purpose, as a means of evading the jurisdiction of their domestic courts and the application of their national law. It is meant to protect – and thus encourage – *international investment*."); Writ, § 275; SoR, §§ 248-249.

¹¹⁵⁵ *TSA Spectrum de Argentina S.A. v. Argentine Republic*, ICSID Case No. ARB/05/5, Award dated 19 Dec. 2008, §§ 159-162 (**Exhibit RF-74**).

¹¹⁵⁶ See SoA, § 728.

¹¹⁵⁷ See, e.g., *RREEF Infrastructure (G.P.) Ltd. v. Kingdom of Spain*, ICSID Case No. ARB/13/30, Decision on Jurisdiction dated 6 June 2016, §§ 129-134 (Exhibit HVY-184) (summarizing respondent's defenses as to jurisdiction *ratione personae*).

¹¹⁵⁸ English original: "the passage cited (but conspicuously not quoted) by HVY (...) bears upon indirect investment and shell companies and says strictly nothing about the nationality of the investor." Expert Opinion of Prof. Pellet § 28 (**Exhibit RF-D16**).

¹¹⁵⁹ English original: "share[d] the position taken under the ECT by the tribunal in the Yukos case" in *Charanne B.V. v. Kingdom of Spain*, SCC Case No. 062/2012, Final Awards dated 21 Jan. 2016, § 417 (Exhibit HVY-183).

case.¹¹⁶⁰ Neither *RREEF* nor *Charanne*, moreover, involved circumstances where the ultimate owners had abused the shell entities' corporate form for unlawful purposes – as is the case here.¹¹⁶¹ Indeed, the *Charanne* tribunal agreed that “it is perfectly conceivable to lift the corporate veil and ignore the legal personality of an investor in the case of fraud.”¹¹⁶² These veil-piercing principles are detailed further below in §§ 710 et seq.

695. Nothing in the ECT suggests that the Contracting Parties intended to derogate from the fundamental international law principles establishing that international investment law protects investments made by foreign (not host State) investors and granting standing for claims by beneficial (not nominal) owners. Indeed, it is equally well established that “an important principle of international law should not be held to have been tacitly dispensed with by international agreement, in the absence of words making clear an intention to do so.”¹¹⁶³ Here, the drafters of the ECT did no such thing. Accordingly, these international law principles further support the proper contextual reading of the ECT: namely, that it promotes and protects investments made by investors from other Contracting Parties, and not round-trip investments made by nationals of the host State.

(b)(ii)(iv) *Subsequent State Practice Confirms That The ECT Protects Investments By Investors From Other Contracting Parties, Not Round-Trip Investments Via Shell Companies*

¹¹⁶⁰ English original: "calls for the same criticisms". Expert Opinion of Prof. Pellet § 28 (**Exhibit RF-D16**).

¹¹⁶¹ See *supra* chapter III.B.

¹¹⁶² English original: "it is perfectly conceivable to lift the corporate veil and ignore the legal personality of an investor in the case of fraud" in *Charanne B.V. v. Kingdom of Spain*, SCC Case No. 062/2012, Final Awards dated 21 Jan. 2016, § 415 (Exhibit HVY-183).

¹¹⁶³ English original: "an important principle of international law should not be held to have been tacitly dispensed with by international agreement, in the absence of words making clear an intention to do so." in *Noble Ventures, Inc. v. Romania*, ICSID Case No. ARB/01/11, Award dated 12 Oct. 2005, § 55 (**Exhibits RF-342**); see also, e.g., *European American Investment Bank AG (Austria) v. The Slovak Republic*, PCA Case No. 2010-17, Award on Jurisdiction dated 22 Oct. 2012, § 332 (**Exhibit RF-343**) ("[W]here a treaty is silent on a subject it cannot be presumed to have departed from an established rule of customary international law"); Expert Opinion of Prof. Pellet § 30 (**Exhibit RF-D16**) ("In the present case, it belongs to the Tribunal to take into account the very general principle according to which, as a matter of principle, investment law aims at protecting *international* investments and not *domestic* investments. Said otherwise, the interpretation of the ECT given by HVY could only be envisaged if the Parties' intent not to apply this general rule would have been made clear in the wording of this provision.") (emphasis in original).

696. Article 31(3) of the VCLT provides that, “together with the context,” the interpretation of a treaty also “shall” take into account the “subsequent practice” of the State Parties.¹¹⁶⁴ The subsequent practice of a large number of ECT Contracting Parties in connection with later investment treaties has remained consistent with, and thus reinforces, the exclusion of round-trip investments from the scope of the ECT. Most recently, the State Parties to the CETA treaty between Canada, the European Union, and its Member States (which has been provisionally applied since September 2017) expressly agreed to exclude shell companies from the scope of treaty protections. The Joint Interpretative Instrument on CETA treaty, concluded by the State Parties at the time of signature, states:

CETA requires a real economic link with the economies of Canada or the European Union in order for a firm to benefit from the agreement and prevents ‘shell’ or ‘mail box’ companies established in Canada or the European Union by investors of other countries from bringing claims against Canada or the European Union and its Member States.¹¹⁶⁵

697. The Joint Interpretative Instrument further states that it “provides, in the sense of Article 31 of the Vienna Convention on the Law of Treaties, a clear and unambiguous statement of what [the State Parties] agreed in a number of CETA treaty provisions that have been the object of public debate and concerns and provides an agreed interpretation thereof.”¹¹⁶⁶ The State Parties to CETA treaty thus agreed, reinforced, and expressly sought to eliminate even the slightest doubt, that shell investment vehicles could not be used to gain access to treaty protections and dispute resolution procedures which would not be available to the ultimate owners of those vehicles. Likewise, in its 2014 consultation notice to the proposed Transatlantic Trade and Investment Partnership (“TTIP”) between the EU and the United States, the EU specified that “[s]hell companies are not protected. Only substantive

¹¹⁶⁴ English original: Article 31(3): “*There shall be taken into account, together with the context (...) (b) Any subsequent practice in the application of the treaty which establishes the agreement of the parties regarding its interpretation.*”

¹¹⁶⁵ English original: “*CETA requires a real economic link with the economies of Canada or the European Union in order for a firm to benefit from the agreement and prevents ‘shell’ or ‘mail box’ companies established in Canada or the European Union by investors of other countries from bringing claims against Canada or the European Union and its Member States*” in Joint Interpretative Instrument on CETA dated 14 January 2017, § 6(d); *see also* European Commission, Directorate-General for Trade, Investment Provisions in the EU-Canada Free Trade Agreement (CETA) dated Feb. 2016, § 1 (“*CETA does not protect so-called ‘shell’ or ‘mailbox’ companies. To be qualified as an investor, it is necessary to have real business operations in the territory of one of the Parties.*”).

¹¹⁶⁶ English original: “*provides, in the sense of Article 31 of the Vienna Convention on the Law of Treaties, a clear and unambiguous statement of what [the State Parties] agreed in a number of CETA provisions that have been the object of public debate and concerns and provides an agreed interpretation thereof.*” in Joint Interpretative Instrument on CETA dated 14 January 2017, § 1(e).

business operations in the territory of one of the Parties could qualify as an ‘investor.’”¹¹⁶⁷

These recent notable texts, among others, reflect the subsequent practice of a sizeable number of ECT Contracting Parties, and thus underscore that the ECT does not protect round-trip investments via shell companies.

(b)(ii)(v) *Recourse To The Travaux Préparatoires Is Unnecessary – And, In Any Event, Does Not Support HVY’s Misinterpretation Of The Treaty*

698. Article 32 of the VCLT provides for “[r]ecourse . . . to supplementary means of interpretation, including the preparatory work of the treaty,” in order to confirm the meaning resulting from application of Article 31, or to determine the meaning when that result is “ambiguous or obscure” or “[l]eads to a result which is manifestly absurd or unreasonable.”¹¹⁶⁸ HVY erroneously argue that the ECT’s *travaux préparatoires* “explicitly confirm that the ECT States deliberately have opted” that “incorporation of the company in an ECT State is the only requirement for being designated as an Investor.”¹¹⁶⁹ HVY note, in particular, that certain State delegates to the ECT negotiations suggested that Article 1(7) include additional language (e.g., as to investor ownership and control), and that the suggested additions were not included in the final Treaty text.¹¹⁷⁰ It is self-evident, however, that the delegate statements on which HVY rely are *not* explicit confirmation of HVY’s misinterpretation of the Treaty. Just the opposite: they indicate that a number of States wanted to ensure that the ECT did not afford investor protections on the basis of State of incorporation alone.

699. Notably, moreover, HVY do not – and cannot – point to any negotiating history that would support their unfounded claim that the Treaty supports roundtrip investing by nationals of the host State (scheme A-B-A). Indeed, Professor Pellet concludes that “there is no need to turn to the *travaux préparatoires*” on this issue because a proper contextual reading of the Treaty text per VCLT Article 31, as detailed above, establishes that “[t]here is no doubt

¹¹⁶⁷ English original: “[s]hell companies are not protected. Only substantive business operations in the territory of one of the Parties could qualify as an ‘investor.’” in European Commission, Directorate-General for Trade, Consultation Notice Regarding TTIP dated 27 Mar. 2014.

¹¹⁶⁸ English original: Article 32 VCLT: “Recourse may be had to supplementary means of interpretation, including the preparatory work of the treaty and the circumstances of its conclusion, in order to confirm the meaning resulting from the application of article 31, or to determine the meaning when the interpretation according to article 31: (a) leaves the meaning ambiguous or obscure; or (b) leads to a result which is manifestly absurd or unreasonable.”

¹¹⁶⁹ SoA, § 727.

¹¹⁷⁰ SoA, § 727.

nor ambiguity as to the definition of an 'investor' within the meaning of the ECT."¹¹⁷¹

Professor Pellet also observes that "there is not much to conclude from the *travaux* in respect of the question of national investors – which can probably be explained by the fact that it was granted that the ECT would only apply to foreign investors."¹¹⁷² Nonetheless, Professor Pellet notes the following:

"They [the *travaux*] show however that:

- various States' delegations were concerned by the issue of shell companies;
- however, the discussions on precise criteria were not conclusive; and
- as a compromise, it seems that it was eventually decided to add a clause of Denial of Benefits in Article 17 and to include criteria relating to the control of an investment into the Joint Ministerial Declaration included in the Final Act of the Conference.

However, here again, the question of investments by nationals of the host State of the investment was not expressly addressed – and very probably for the reason that it went without saying that it did not arise since the object and purpose of the ECT was to attract and protect *foreign* investments.¹¹⁷³

700. Accordingly, given the ordinary meaning of the ECT text, in full and proper context and in light of the Treaty's object and purpose, recourse to the *travaux* as a supplemental means of interpretation is unnecessary. Indeed, it should be no surprise that the negotiating history does not expressly address the self-evident proposition that the Treaty was intended to attract and protect foreign investments – and not roundtrip investments by nationals of a

¹¹⁷¹ English original: "there is no need to turn to the *travaux préparatoires* (...) There is no doubt nor ambiguity as to the definition of an 'investor' within the meaning of the ECT." Expert Opinion of Prof. Pellet § 33 (**Exhibit RF-D16**).

¹¹⁷² English original: "there is not much to conclude from the *travaux* in respect of the question of national investors – which can probably be explained by the fact that it was granted that the ECT would only apply to foreign investors." Expert Opinion of Prof. Pellet § 34 (**Exhibit RF-D16**).

¹¹⁷³ English original: "They show however that: - various States' delegations were concerned by the issue of shell companies; - however, the discussions on precise criteria were not conclusive; and - as a compromise, it seems that it was eventually decided to add a clause of Denial of Benefits in Article 17 and to include criteria relating to the control of an investment into the Joint Ministerial Declaration included in the Final Act of the Conference. However, here again, the question of investments by nationals of the host State of the investment was not expressly addressed – and very probably for the reason that it went without saying that it did not arise since the object and purpose of the ECT was to attract and protect *foreign* investments." (emphasis in original) Expert Opinion of Prof. Pellet §§ 52-53 (**Exhibit RF-D16**).

host State. HVY's claim that the *travaux* somehow "explicitly confirm"¹¹⁷⁴ their flawed reading of the Treaty is demonstrably false.

(b)(iii) *HVY Also Did Not Make An "Investment" Under The ECT Because They Did Not Make An Economic Contribution In The Host State*

701. Even setting aside the fact that the ECT does not protect the roundtrip (A-B-A-type) investment at issue here, HVY also did not make an "Investment" because they are pass-through shell entities – and the Treaty extends protections only to investments by foreign investors that make an economic contribution in the territory of the host State. HVY does not address this issue at all in their Statement of Appeal, instead noting in one conclusory sentence that Article 1(6) "explicitly comprises shares in a company."¹¹⁷⁵ HVY ignore the fact that multiple ECT provisions specify that a foreign investor must actively "mak[e] the investment" within "the Area of" a Contracting Party:

- Article 1(6) specifies that "the term 'Investment' includes all investments, whether existing at or made after the later of the date of entry into force of this Treaty for the Contracting Party of the *Investor making the investment* and that for the Contracting Party in the Area of which the *investment is made*"¹¹⁷⁶
- The Understanding with respect to Article 1(6), which as noted above provides relevant context for interpretation of the Treaty,¹¹⁷⁷ provides "greater clarity as to whether an Investment *made in the Area of one Contracting Party* is controlled, directly or indirectly, by an Investor of any other Contracting Party."¹¹⁷⁸
- Article 1(8) underscores that an investment requires some active contribution by the investor: "'Make Investments' or 'Making Investments' means establishing new Investments, acquiring all or part of existing Investments or moving into different fields of Investment activity."¹¹⁷⁹

¹¹⁷⁴ SoA, § 727.

¹¹⁷⁵ SoA, § 740.

¹¹⁷⁶ English original: "the term 'Investment' includes all investments, whether existing at or made after the later of the date of entry into force of this Treaty for the Contracting Party of the Investor making the investment and that for the Contracting Party in the Area of which the investment is made."

¹¹⁷⁷ *See supra* §§ 683-684.

¹¹⁷⁸ English original: "for greater clarity as to whether an Investment made in the Area of one Contracting Party is controlled, directly or indirectly, by an Investor of any other Contracting Party". Final Act of the European Energy Charter Conference, Understanding IV.3 at article 1(6) ECT. *See also* Pleading Notes RF, § 37.

¹¹⁷⁹ English original: "'Make Investments' or 'Making Investments' means establishing new Investments, acquiring all or part of existing Investments or moving into different fields of Investment activity".

This text is an unofficial translation of the Dutch original. In case of any discrepancies, the Dutch original shall prevail.

- Article 17(1), as also discussed above,¹¹⁸⁰ likewise provides for the denial of Treaty benefits for entities owned or controlled by third-State nationals with “no substantial business activities in the Area of the Contracting Party in which [the entity] is organized.”¹¹⁸¹
- Various other ECT provisions reinforce that an investor must make an economic contribution within the host State.¹¹⁸²

702. Accordingly, Professor Pellet concludes “that to qualify as an investment under Article 1(6) ECT, as is the case with other prominent multilateral or bilateral investment treaties, it is required that funds with a foreign origin are injected on the territory of a Contracting State. I can only repeat again that this is the very *raison d’être* of the ECT and, more generally, of the international law of investments.”¹¹⁸³ Indeed, as Professor Pellet notes, the ECT requirement that a foreign investor make an economic contribution in the host State is in accord with well-established principles of international law.¹¹⁸⁴ In the frequently-cited decision in *Salini v. Morocco*, the tribunal articulated several criteria for an investment warranting protection under international law: “contributions”; “a certain duration of performance”; “a participation in the risks of the transaction”; and “contribution to the economic development of the host State.”¹¹⁸⁵ Many tribunals have adopted these so-called “*Salini* factors,” including the requirement that a foreign investor make a substantial

¹¹⁸⁰ See *supra* §§ 680-682.

¹¹⁸¹ English original: “no substantial business activities in the Area of the Contracting Party in which [the entity] is organized”.

¹¹⁸² See, e.g., Energy Charter Treaty, Preamble (providing that “these commitments will be applied to the Making of Investments pursuant to [the Treaty]”); Art. 1(6) (referring to the “Investor making the investment” and the “Contracting Party in the Area of which the investment is made”); Art. 9 (noting that “open capital markets” are important to “the making of and assisting with regard to Investments”); Art. 10 (referring multiple times to obligations that Contracting Parties owe to Investors of other Contracting Parties as to the “Making of Investments”); Art. 11 (creating obligations for Contracting Parties regarding Key Personnel working in connection “with the making . . . of relevant Investments”); Art. 45 (referring to Contracting Party obligations owed to “Investments made in its Area” when provisional application is terminated); Art. 47 (applying the Treaty to “Investments made in the Area of a Contracting Party by Investors of other Contracting Parties” for 20 years after the Contracting Party withdraws from the Treaty).

¹¹⁸³ English original: “that to qualify as an investment under Article 1(6) ECT, as is the case with other prominent multilateral or bilateral investment treaties, it is required that funds with a foreign origin are injected on the territory of a Contracting State. I can only repeat again that this is the very *raison d’être* of the ECT and, more generally, of the international law of investments.” Expert Opinion of Prof. Pellet § 67 (**Exhibit RF-D16**); see also *id.* § 62 (“[I]nvestment treaties are not indifferent to the origin of funds.”).

¹¹⁸⁴ Expert Opinion of Prof. Pellet §§ 60-68 (**Exhibit RF-D16**).

¹¹⁸⁵ *Salini Construttori S.P.A. et al. v. Kingdom of Morocco*, ICSID Case No. ARB/00/4, Decision on Jurisdiction dated 23 July 2001, § 52 (**Exhibit RF-344**) (The *Salini* tribunal further observed that “these various elements may be interdependent,” and thus “these various criteria should be assessed globally.”).

economic contribution within the host State.¹¹⁸⁶ Other tribunals, even when not strictly adopting the *Salini* ruling, have recognized that the ordinary meaning of the term “investment” involves certain objective criteria, such as a contribution, duration, and risk.¹¹⁸⁷ Such criteria also have been expressly enumerated in recent treaties – including CETA¹¹⁸⁸ which, as discussed above, reflects subsequent practice of many of the ECT Contracting Parties, and thus informs the interpretation of the ECT.¹¹⁸⁹ Further, it is correctly acknowledged that “the case law is progressively evolving towards a greater recognition of the *Salini* criteria and an economic, as opposed to a purely legal, conception of investment – in fact, the ordinary meaning of the word.”¹¹⁹⁰

¹¹⁸⁶ See, e.g., *Joy Mining Machinery Limited v. The Arab Republic of Egypt*, ICSID Case No. ARB/03/11, Award on Jurisdiction dated 6 Aug. 2004, §§ 53-63 (**Exhibit RF-345**) (applying *Salini* factors and declining jurisdiction over a purported investment because, among other reasons, “there is nothing here to be compared with the concept of ‘contrats de développement économique’”); *Patrick Mitchell v. The Democratic Republic of Congo*, ICSID Case No. ARB/99/7, Decision on the Application for Annulment of the Award dated 1 Nov. 2006, §§ 27-48 (**Exhibit RF-346**) (applying *Salini* factors and annulling the award because the tribunal had failed to identify what, if any, economic contribution the claimant made); *Phoenix Action, Ltd. v. The Czech Republic*, ICSID Case No. ARB/06/5, Award dated 15 Apr. 2009 §§ 114-133, 140 (analyzing *Salini* factors and finding that the claimant had not contributed to development of economic activities because the claimant had not “really the intention to engage in economic activities There are strong indicia that no economic activity in the market place was either performed or even intended by [the claimant] the whole operation was not an economic investment, based on the actual or future value of the companies, but indeed, simply a rearrangement of assets within a family. . . .”).

¹¹⁸⁷ See, e.g., *Saba Fakes v. Republic of Turkey*, ICSID Case No. ARB/07/20, Award dated 14 July 2010, § 110 (**Exhibit RF-347**) (finding that “the criteria of (i) a contribution, (ii) a certain duration, and (iii) an element of risk, are both necessary and sufficient to define an investment,” and observing that “this approach reflects an objective definition of ‘investment’ that embodies specific criteria corresponding to the ordinary meaning of the term ‘investment’”); *KT Asia Investment Group B.V. v. Republic of Kazakhstan*, ICSID Case No. ARB/09/8, Award dated 17 Oct. 2013, §§ 170-171 (**Exhibit RF-348**) (finding that “a contribution of money or assets (that is, a commitment of resources), duration and risk form part of the objective definition of the term ‘investment’”); see also *MNSS B.V. et al. v. Montenegro*, ICSID Case No. ARB(AF)/12/8, Award dated 4 May 2016, § 189 (**Exhibit RF-349**) (finding that “[t]he elements of a contribution for certain duration with the assumption of certain risk seem to be inherent to the plain meaning of the term ‘investment’”).

¹¹⁸⁸ Article 8.1 CETA Treaty (“Investment means every kind of asset that an investor owns or controls, directly or indirectly, that has the characteristics of an investment, which includes a certain duration and other characteristics such as the commitment of capital or other resources, the expectation of gain or profit, or the assumption of risk.”); see also Joint Interpretative Instrument on the Comprehensive Economic and Trade Agreement (CETA) between Canada and the European Union and its Member States dated 14 Jan. 2017, § 6(d) (“CETA requires a real economic link with the economies of Canada or the European Union in order for a firm to benefit from the agreement and prevents ‘shell’ or ‘mail box’ companies established in Canada or the European Union by investors of other countries from bringing claims against Canada or the European Union and its Member States.”) (emphasis added).

¹¹⁸⁹ See *supra* §§ 696 et seq.; see also Article 31(3) VCLT (“There shall be taken into account, together with the context . . . (b) Any subsequent practice in the application of the treaty which establishes the agreement of the parties regarding its interpretation.”).

¹¹⁹⁰ English original: “the case law is progressively evolving towards a greater recognition of the *Salini* criteria and an economic, as opposed to a purely legal, conception of investment – in fact, the ordinary meaning of the word” in E. Gaillard and Y. Banifatemi, *The Long March towards a Jurisprudence*

703. In a recent 2017 decision, for example, the tribunal in *Capital Financial Holdings v. Cameroon* denied jurisdiction where it found that the nominal claimant was merely a vehicle for a roundtrip investment by a national of the host State. The claimant's alleged investment was its shareholding in a Cameroon bank, CBC, as well as loans which the claimant had made to CBC. The tribunal found, however, that the claimant had purchased its CBC shares from its own ultimate owner, a national of Cameroon. Further, the loan purportedly made by the claimant to CBC had, in turn, been lent to the claimant by its direct majority owner, with no indication of any intent to repay. The tribunal held:

[T]he real question is whether the one who is acting has made the investment himself and bears the risks, and in this regard at least, the origins of funds allegedly invested cannot be totally neglected. This is the case in particular if, *by an artificial circular movement, amounts are derived directly or indirectly from funds used by persons affected by the measures in the State* against which the proceedings are opened.¹¹⁹¹

704. The tribunal further noted that the "delimitation between the question of the origin of the funds and the person who made an investment is particularly difficult when the transaction concerns several companies controlled by the same person or persons."¹¹⁹² Ultimately, based on the findings that the alleged investments were the result of purely circular transactions, with no contribution by the claimant itself, the tribunal concluded that "the claimant had not made a substantial contribution in the host State," and accordingly that it did not have jurisdiction.¹¹⁹³

Constante on the Notion of Investment, in BUILDING INTERNATIONAL INVESTMENT LAW – THE FIRST 50 YEARS OF ICSID (M. Kinnear et al. eds., 2015), at 124-125 (**Exhibit RF-350**); *see also* Expert Opinion of Prof. Pellet § 70 (**Exhibit RF-D16**) ("I note that eminent lawyers amongst the team representing HVY consider in a recent paper that the 'economic definition of an investment' which has been used by the *Salini* Tribunal 'could be said to be the ordinary meaning of the word investment.'").

¹¹⁹¹ French original: "la vraie question reste celle de savoir si celui qui agit a fait lui-même l'investissement et en supporte les risques et, à cet égard au moins, l'origine des fonds prétendument investis ne peut être complètement négligée. C'est notamment le cas si, par un mouvement circulaire artificiel, des montants proviennent directement ou indirectement de fonds utilisés par des personnes visées par les mesures dans l'Etat contre lequel la procédure est ouverte." in *Capital Financial Holdings Luxembourg S.A. v. Republic of Cameroon*, ICSID Case No. ARB/15/18, Award dated 22 June 2017, § 426 (**Exhibit RF-351**) (emphasis added).

¹¹⁹² French original: "La délimitation entre la question de l'origine des fonds et la personne ayant fait un investissement est particulièrement délicate lorsque l'opération concerne plusieurs entreprises contrôlées par la ou les mêmes personnes." *Capital Financial Holdings Luxembourg S.A. v. Republic of Cameroon*, ICSID Case No. ARB/15/18, Award dated 22 June 2017, § 428 (**Exhibit RF-351**).

¹¹⁹³ French original: "Au vu de tous ces éléments, le tribunal a décidé que la partie demanderesse n'avait pas fait une contribution substantielle dans l'Etat d'accueil, et a décliné sa compétence." *Capital Financial Holdings Luxembourg S.A. v. Republic of Cameroon*, ICSID Case No. ARB/15/18, Award dated 22 June 2017, § 428 (**Exhibit RF-351**).

705. In *Alapli v. Turkey*, as discussed above, the tribunal similarly dismissed claims brought under the ECT while emphasizing that “Turkey agreed to arbitrate with Dutch entities that had actually made investments in Turkey,” and that this “jurisdictional principle must serve as the foundation in construing the notions of ‘investor’ and ‘investment.’”¹¹⁹⁴ The claimant in *Alapli* had not made any contribution to the alleged investment; rather, it served as a conduit for funds channeled from parties in a third State and the host State. One arbitrator, in particular, found that the *Salini* criteria were “useful,” and ruled to dismiss the claims because the ECT does not allow for “jurisdiction over a claim brought by an entity which played no meaningful role contributing to the relevant host state project, whether by way of money, concession rights or technology.”¹¹⁹⁵
706. By comparison, in *Energoalliance v. Moldova*, a majority of the tribunal disregarded the dissenting president’s finding that an investment under the ECT must “be acquired as a result of, or in connection with, an economic process of investment.”¹¹⁹⁶ The majority decision was set aside by the Paris Court of Appeal, which confirmed that there could be no “Investment” under the ordinary meaning of Article 1(6) without some economic “contribution” by the claimant in the host State. The court concluded that Moldova “rightly relies on the condition of contribution, in accordance with the ordinary meaning to be given to the terms of the Treaty in their context and in the light of its object and purpose which is ‘to catalyse economic growth by means of measures to liberalize investment and trade in

¹¹⁹⁴ English original: "Turkey agreed to arbitrate with Dutch entities that had actually made investments in Turkey (...) jurisdictional principle must serve as the foundation in construing the notions of 'investor' and 'investment'." *Alapli Elektrik B.V. v. Republic of Turkey*, ICSID Case No. ARB/08/13, Award dated 16 July 2012, §§ 335-336 (**Exhibit RF-139**).

¹¹⁹⁵ English original: "jurisdiction over a claim brought by an entity which played no meaningful role contributing to the relevant host state project, whether by way of money, concession rights or technology." *Alapli Elektrik B.V. v. Republic of Turkey*, ICSID Case No. ARB/08/13, Award dated 16 July 2012, §§ 382, 389 (**Exhibit RF-139**); see also *id.* § 350-351 ("To be an investor a person must actually make an investment, in the sense of an active contribution. Status as a national of the other contracting state is not in itself enough. . . . To the extent that contributions were made, they came from nationals or companies of the United States and Turkey.").

¹¹⁹⁶ English original: be acquired as a result of, or in connection with, an economic process of investment." *Energoalliance v. Republic of Moldova*, UNCITRAL, Dissenting Opinion of Presiding Arbitrator Dominic Pellew dated 23 Oct. 2013, § 11 (**Exhibit RF-352**); see also *Energoalliance v. Republic of Moldova*, UNCITRAL, Award dated 23 Oct. 2013, §§ 241-247 (**Exhibit RF-353**) (majority providing for "the securing of a more broad jurisdiction of investment arbitration through renouncing a set of rigorous criteria").

energy.”¹¹⁹⁷ Accordingly, the tribunal could not properly exercise jurisdiction under the ECT.¹¹⁹⁸

707. In another recent ruling, the High Court of England and Wales similarly ruled that an investment under the applicable treaty required an economic contribution, when rejecting an application to unfreeze funds to pursue ICSID claims. In particular, the court ruled that the creation by Turkish investors of a new holding company in England “*did not involve the introduction or injection of any new or additional money or value,*” but instead “*resulted in nothing more than a number of Turkish individuals exercising the same ownership and control . . . as they had previously been able to exercise.*”¹¹⁹⁹ Accordingly, the creation of the intermediary holding company “*so that operations can be run from a base in England instead of a base in Turkey involve no investment in Turkey*” – and, indeed, was an “*essential[ly] artificial[ly]*” transaction “*when viewed from the perspective of the ICSID system.*”¹²⁰⁰
708. In this case, HVY made no economic contribution in the Russian Federation. Indeed, there simply was no contribution by any foreign investor, as the ECT requires. While HVY were the nominal holders of shares in Yukos, the record establishes that HVY obtained those shares through an intricate series of related-party transactions designed to conceal the illegal origins and true owners of the shares – *i.e.*, the Russian Oligarchs, who acquired the shares through the manipulation of a privatization process that, by its very terms, excluded the participation of foreign investors.¹²⁰¹ Further, the share transfers across the extensive network of shell companies (owned and controlled by the Oligarchs) were never financed

¹¹⁹⁷ French original: “que dès lors la recourante [Moldova] se prévaut à bon droit de la condition d'apport, selon le sens ordinaire à attribuer aux termes du traité dans leur contexte et à la lumière de son objet et de son but qui est decatalyser la croissance économique par des mesures destinées à libéraliser les investissements et les échanges en matière d'énergie.” *Republic of Moldova v. Komstroy*, Paris Court of Appeal, Judgment dated 12 Apr. 2016, at 6 (**Exhibit RF-354**).

¹¹⁹⁸ *Republic of Moldova v. Komstroy*, Paris Court of Appeal, Judgment dated 12 Apr. 2016, § 6 (**Exhibit RF-354**).

¹¹⁹⁹ English original: “*did not involve the introduction or injection of any new or additional money or value [but instead] resulted in nothing more than a number of Turkish individuals exercising the same ownership and control (...) as they had previously been able to exercise.*” *Koza Ltd. v. Mustafa Akçil*, High Court of Justice, Chancery Division, Judgment dated 16 Nov. 2017, §§ 120-121 (**Exhibit RF-393**).

¹²⁰⁰ English original: “*so that operations can be run from a base in England instead of a base in Turkey involve no investment in Turkey (...) essential[ly] artificial [transaction] when viewed from the perspective of the ICSID system*”, *Koza Ltd. v. Mustafa Akçil*, High Court of Justice, Chancery Division, Judgment dated 16 Nov. 2017, §§ 120-121 (**Exhibit RF-393**).

¹²⁰¹ *See supra* chapter III.B(a).

by actual payments of cash; rather, the funding for these transactions was always provided by promissory notes or other types of credit extended by Bank Menatep (itself owned and controlled by the Russian Oligarchs). HVY made no economic contribution to the Russian Federation, through their shareholdings in Yukos or otherwise. Indeed, rather than making any contribution, HVY were used by the Oligarchs to unlawfully channel billions of dollars out of the Russian Federation. Professor Pellet confirms that, “[a]lthough, from my point of view, the mere fact that the operation cannot be characterized as ‘foreign’ is a sufficient argument to dismiss the HVY’s claims . . . the absence of any contribution of the HVY’s so-called ‘investment’ to the economic development of the Russian Federation reinforces the general line of argument”¹²⁰² that the tribunal could not validly exercise jurisdiction over the claims.

709. HVY offer no substantive response on their failure to make any economic contribution in the Russian Federation. Rather, they argue in the Statement of Appeal, as they did before the District Court,¹²⁰³ that the Russian Federation raised these Article 1(6) defenses “in its Statement of Reply for the first time” and thus cannot raise such a ground “out of time” for setting aside the Awards.¹²⁰⁴ In fact, the Russian Federation expressly and repeatedly articulated in the Writ of Summons that the Tribunal lacked jurisdiction under Article 1(6) due to the lack of an economic contribution in the host State, and in particular that the Tribunal lacked jurisdiction “*under Article 1(6) and 1(7) ECT, because (i) Claimants are shell company proxies for Russian nationals, and did not inject any foreign capital into the Russian Federation, and (ii) their Yukos shares are accordingly not investments entitled to the benefits of the ECT.*”¹²⁰⁵ Accordingly, the Russian Federation plainly and timely raised the jurisdictional objection that HVY’s shares could not constitute an investment under Article 1(6) because they made no economic contribution in the host State. HVY’s claim that the objection somehow violates Article 1064(5) DCCP is without merit.

¹²⁰² English original: “[a]lthough, from my point of view, the mere fact that the operation cannot be characterized as ‘foreign’ is a sufficient argument to dismiss the HVY’s claims (...) the absence of any contribution of the HVY’s so-called ‘investment’ to the economic development of the Russian Federation reinforces the general line of argument.” Expert Opinion of Prof. Pellet § 74 (**Exhibit RF-D16**).

¹²⁰³ SoRej., § 186.

¹²⁰⁴ SoA, §§ 722, 739.

¹²⁰⁵ (emphasis added). Writ, § 20(b). *See also id.* § 101(b) (again arguing that the Tribunal lacked jurisdiction “*under Article 1(6) and 1(7) ECT, because (i) Claimants are shell company proxies for Russian nationals, and did not inject any foreign capital into the Russian Federation, and (ii) their Yukos shares are accordingly not investments entitled to the benefits of the ECT*”); *see also id.* §§ 257-261 (explaining that HVY are “mere shell companies created solely to hold the oligarchs’ Yukos shares”).

(b)(iv) *The Russian Oligarchs' Abuses Of The HVY Corporate Structure For Illegal Purposes Warrant Lifting The Corporate Veil To Expose The Russian Nationals Beneath*

710. Even if the ECT did not exclude round-trip investments – which it does – HVY's investments still would not be entitled to Treaty protections due to the fact that they ultimately are owned and controlled by Russian nationals. Under well-established veil-piercing principles raised in the Writ,¹²⁰⁶ the Russian Oligarchs were not permitted to hide behind the HVY corporate structure in the arbitration after they had abused that very same structure to commit fraud, bribery, and other crimes. As detailed above,¹²⁰⁷ those abuses included, among other things, the payment of at least USD 613.5 million in bribes to the Red Directors through sham contracts concluded by YUL; the concealment of the ownership and control structure of Yukos; the prevention of de-privatization as a consequence of the illegal Yukos share acquisitions in 1995 and 1996; the channeling of the Russian Oligarch's ill-gotten riches, including the illegally-obtained Yukos shares, out of the Russian Federation; and the evasion of taxes on a massive scale, including through fraudulent abuses of the 1998 Cyprus-Russia DTA. Accordingly, the Arbitral Tribunal could have, and should have, lifted HVY's corporate veil to expose the Russian national investors beneath, and dismissed for lack of jurisdiction on that basis. This same conclusion is required, whether through application of international law or the national law at HVY's respective places of incorporation.

(b)(iv)(i) *International Law*

711. It is a fundamental principle under international law that an abuse of the corporate structure, such as in the case of illegality or fraud, warrants piercing the corporate veil. The seminal case for veil piercing under international law is *Barcelona Traction*. In that case, the International Court of Justice held that “*the process of lifting the veil, being an exceptional one admitted by municipal law in respect of an institution of its own making, is equally admissible to play a similar role in international law.*”¹²⁰⁸ The ICJ drew upon “*the*

¹²⁰⁶ See, e.g., Writ, §§ 268-276 (addressing cases where tribunals looked through corporate nationality of a nominal claimant to the nationality of the ultimate controlling investor); see also SoR, § 265 n.431 (noting that “it is well-established that corporate veils may be pierced if the corporate form is used as a device or vehicle for abuse or tax evasion”) (citing international legal authorities).

¹²⁰⁷ See *supra* chapter III.B.

¹²⁰⁸ *The Barcelona Traction, Light and Power Company, Limited (Belgium v. Spain)*, ICJ Reports 1970 (Judgment of 5 Feb. 1970), § 58 (R-196) (C-930): “*the process of lifting the veil, being an exceptional*

*wealth of practice already accumulated on the subject in municipal law,” which indicated that “the veil is lifted, for instance, to prevent the misuse of the privileges of legal personality, as in certain cases of fraud or malfeasance, to protect third persons such as a creditor or purchaser, or to prevent the evasion of legal requirements of obligations.”*¹²⁰⁹

In such cases of abuse or fraud, an international tribunal may pierce the corporate veil – or, as Judge Sir Gerald Fitzmaurice observed, “*it would be more accurate to say that it registers the absence of all effective personality, of any effectual intermediary between the shareholders and the rights infringed.*”¹²¹⁰

712. Numerous tribunals have accepted that the veil should be pierced when the corporate form has been abused to perpetrate fraud or malfeasance. In *Cementownia v. Turkey*, for example, the tribunal expressly relied on *Barcelona Traction* in its decision to pierce the veil and dismiss for lack of jurisdiction.¹²¹¹ In that case, the claimant (a Polish company) brought claims under the ECT regarding shareholdings in Turkish companies which it allegedly had purchased from a Turkish national, Kemal Uzan. The tribunal found that the claimant failed to establish that it had legally acquired the shares,¹²¹² and in fact that the claimant and Uzan had “*fabricate[d] the transaction to protect the Uzan family’s economic*

one admitted by municipal law in respect of an institution of its own making, is equally admissible to play a similar role in international law.”

¹²⁰⁹ *The Barcelona Traction, Light and Power Company, Limited (Belgium v. Spain)*, ICJ Reports 1970 (Judgment of 5 Feb. 1970), § 56 (R-196) (C-930): “*the wealth of practice already accumulated on the subject in municipal law,*” which indicated that “*the veil is lifted, for instance, to prevent the misuse of the privileges of legal personality, as in certain cases of fraud or malfeasance, to protect third persons such as a creditor or purchaser, or to prevent the evasion of legal requirements of obligations.*”

¹²¹⁰ *The Barcelona Traction, Light and Power Company, Limited (Belgium v. Spain)*, ICJ Reports 1970 (Separate Opinion of Judge Fitzmaurice of 5 Feb. 1970), § 75 (R-196) (C-930): “*it would be more accurate to say that it registers the absence of all effective personality, of any effectual intermediary between the shareholders and the rights infringed.*”

¹²¹¹ *Cementownia “Nowa Huta” S.A. v. Republic of Turkey*, ICSID Case No. ARB(AF)/06/2, Award dated 17 Sept. 2009, §§ 155-159 (RME-1084); *see also, e.g., Saluka Investments BV v. Czech Republic*, UNCITRAL, Partial Award dated 17 Mar. 2006, § 230 (holding that “it might in some circumstances be permissible for a tribunal to look behind the corporate structures of companies involved in proceedings before it . . . where corporate structures had been utilized to perpetrate fraud or other malfeasance”) (C-253); *ADC Affiliate Ltd. v. The Republic of Hungary*, ICSID Case No. ARB/03/16, Award dated 2 Oct. 2006, § 358 (holding that piercing the corporate veil applies “to situations where the real beneficiary of the business misused corporate formalities in order to disguise its true identity and therefore to avoid liability”) (Annex (Merits) C-980); *Rumeli Telekom A.S. v. Republic of Kazakhstan*, ICSID Case No. ARB/05/16, Award dated 29 July 2008, § 328 (Annex (Merits) C-992).

¹²¹² *Cementownia “Nowa Huta” S.A. v. Republic of Turkey*, ICSID Case No. ARB(AF)/06/2, Award dated 17 Sept. 2009, § 119 (RME-1084).

interests and to gain access to international jurisdiction."¹²¹³ The tribunal noted that, "[b]eing a Turkish national holding shares in [the Turkish companies], under the Energy Charter Treaty, Mr. Kemal Uzan could not bring an international claim against his own State."¹²¹⁴ The tribunal further reasoned that, "[e]ven if they did occur, the share transfers would not have been bona fide transactions, but rather attempts . . . to fabricate international jurisdiction where none should exist."¹²¹⁵ On the basis of the fraudulent nature of the share transaction, together with the abusive attempt to manufacture an international claim out of an internal host State dispute, the tribunal looked through the claimant's corporate form and Polish nationality, and dismissed for lack of jurisdiction.¹²¹⁶

713. Other tribunals likewise have dismissed treaty claims upon finding that the true parties-in-interest had abused the corporate form. In *Phoenix Action v. Czech Republic*, for example, the tribunal ruled that an assignment to the claimant by two Czech companies was "an artificial transaction to gain access to ICSID," and ruled that dismissal was required "to ensure that the ICSID mechanism does not protect investments that it was not designed to protect, because they are in essence domestic investments disguised as international investments for the sole purpose of access to this mechanism."¹²¹⁷ In *Alapli v. Turkey*, as

¹²¹³ *Cementownia "Nowa Huta" S.A. v. Republic of Turkey*, ICSID Case No. ARB(AF)/06/2, Award dated 17 Sept. 2009, § 136 (RME-1084): "*fabricate[d] the transaction to protect the Uzan family's economic interests and to gain access to international jurisdiction.*"

¹²¹⁴ *Cementownia "Nowa Huta" S.A. v. Republic of Turkey*, ICSID Case No. ARB(AF)/06/2, Award dated 17 Sept. 2009, § 116 (RME-1084): "*[b]eing a Turkish national holding shares in [the Turkish companies], under the Energy Charter Treaty, Mr. Kemal Uzan could not bring an international claim against his own State*"; see also *id.* (observing that the prohibition on bringing domestic claims in an international arbitration under the ECT was "trite law, but fundamental to the Respondent's objections to jurisdiction").

¹²¹⁵ *Cementownia "Nowa Huta" S.A. v. Republic of Turkey*, ICSID Case No. ARB(AF)/06/2, Award dated 17 Sept. 2009, § 117 (RME-1084) "*[e]ven if they did occur, the share transfers would not have been bona fide transactions, but rather attempts . . . to fabricate international jurisdiction where none should exist*"; see also *id.* § 116 (noting that the claimant's alleged share purchase effectively would transform "what until that point of time had been a purely local grievance arising under local law" into the basis for "an international arbitration applying international law").

¹²¹⁶ See *Cementownia "Nowa Huta" S.A. v. Republic of Turkey*, ICSID Case No. ARB(AF)/06/2, Award dated 17 Sept. 2009, § 156 ("Here the Claimant's conduct is not even close to proper conduct. Had Cementownia actually proven that on May 30, 2003 it legally acquired the shares of CEAS and Kepez, there would still be the question of whether this was treaty shopping of the wrong kind The problem for the Claimant is that the evidence shows that it did not even interpose itself between Mr. Kemal Uzan and the Republic of Turkey. *The transaction that would pose the issue of whether the corporate veil should be pierced was fabricated.*") (emphasis added) (RME-1084).

¹²¹⁷ *Phoenix Action Ltd. v. The Czech Republic*, ICSID Case No. ARB/06/5, Award dated 15 Apr. 2009, §§ 143-144 "*an artificial transaction to gain access to ICSID*" and "*to ensure that the ICSID mechanism does not protect investments that it was not designed to protect, because they are in essence domestic investments disguised as international investments for the sole purpose of access to this mechanism*" (RME-1078).

noted above, one of the arbitrators found that the tribunal could not exercise jurisdiction because “*the introduction of the Dutch company [claimant] had as its main purpose the access to international arbitration which did not exist for the Turkish nationals and the Turkish company.*”¹²¹⁸

714. Notably, in such cases, tribunals pierced the corporate veil and dismissed claims for abuses of the corporate form intended to access treaty dispute mechanisms. In this case, by comparison, the Russian Oligarchs abused the HVY corporate form to further their criminal enterprise – an even graver offense – and then later also abused the corporate form to channel claims by Russian nationals into international proceedings against Russia. Under such circumstances, even the authorities favored by HVY recognize that a nominal claimant’s corporate form should be disregarded. HVY, for example, rely on the often-criticized¹²¹⁹ majority decision in *Tokios Tokeles v. Ukraine* to support their narrow reading of the requirements of an “*Investor.*”¹²²⁰ In that decision, however, the majority recognized that the veil should be pierced when the corporate form is used “*for any improper purpose,*” to include “*fraud,*” “*malfeasance,*” or “*to evade applicable legal requirements or obligations.*”¹²²¹ While no such impropriety was present in *Tokios Tokeles*, there is abundant evidence that it is the case here with HVY.¹²²²

¹²¹⁸ *Alapli Elektrik B.V. v. Republic of Turkey*, ICSID Case No. ARB/08/13, Award dated 16 July 2012, § 393 (**Exhibit RF-139**): “*the introduction of the Dutch company [claimant] had as its main purpose the access to international arbitration which did not exist for the Turkish nationals and the Turkish company.*”; see also SoR, § 234 (discussing *Alapli*).

¹²¹⁹ See, e.g., *TSA Spectrum De Argentina S.A. v. Argentine Republic*, ICSID Case No. ARB/05/5, Award dated 19 Dec. 2008, §§ 145-146 (finding that the “strict constructionist” approach by the *Tokios Tokeles* majority “has not been generally accepted and was also criticised by the dissenting President”) (**Exhibit RF-74**); Markus Burgstaller, *Nationality of Corporate Investors and International Claims Against the Investor’s Own State*, 7 J. WORLD INV. & TRADE 857, 860 (2006) (**Exhibit RF-355**) (observing that “the reasoning of the majority of the Tribunal in *Tokios Tokeles* is flawed, both in terms of law and policy”); Engela C. Schlemmer, *Investment, Investor, Nationality, and Shareholders*, in OXFORD HANDBOOK OF INTERNATIONAL INVESTMENT LAW 49, 80 (Muchlinski, Ortino & Schreuer, eds., 2008) (**Exhibit RF-356**) (observing that the *Tokios Tokeles* majority “seems to be inconsistent with [ICSID’s] object and purpose. The dissenting opinion by the tribunal president, Prosper Weil, seems to be more in line with that object and purpose.”); see also Expert Opinion of Prof. Pellet, § 22 (**Exhibit RF-D16**) (noting that “the famous and powerful dissent of Professor Prosper Weil in *Tokios Tokeles v. Ukraine* applies *mutatis mutandis* to international investment arbitration mechanisms in general”).

¹²²⁰ See, e.g., SoD, §§ II.329-331.

¹²²¹ *Tokios Tokeles v. Ukraine*, ICSID Case No. ARB/02/18, Decision on Jurisdiction dated 29 Apr. 2004 §§ 54-56 (C-1525): “*for an improper purpose*”, including “*fraud*” and “*malfeasance*”, or “*to evade applicable legal requirements or obligations*”.

¹²²² See *supra* chapters III.B and III.C.

(b)(iv)(ii) *National Law Of The Place Of Incorporation*

715. If under Article 1(7) of the ECT, an investor's nationality is determined in accordance with State law,¹²²³ the application of veil-piercing principles under State law in this case arrives at the same result as under international law. Hulley Enterprises Limited and Veteran Petroleum Limited are incorporated in Cyprus, while Yukos Universal Limited is incorporated in the Isle of Man. Under the laws of both jurisdictions, the Russian Oligarchs' abuse of the HVY corporate structure for illegitimate purposes allows for veil piercing.
716. In Cyprus, the Supreme Court held in *Republic of Cyprus v. KEM Taxi Limited*, for example, that the corporate veil may be lifted when the incorporated entity is used for some improper purpose.¹²²⁴ In so holding, the court observed that under English law, which provides the common law foundation for Cypriot law, courts are "willing to[] lift the veil where the device of incorporation is used for some illegal or improper purpose."¹²²⁵ In another case, *Bank of Cyprus v. Republic of Cyprus*, the Supreme Court of Cyprus again confirmed that Cypriot courts "have shown readiness to lift the veil whenever incorporation is used as a device to secure financial advantages or whenever the interposition of a subsidiary is inconsequential to the nature of the transaction."¹²²⁶
717. In his expert opinion on Cyprus law, Mr. Andreas Michaelides confirms that "[t]he common theme running through all the cases in which the court has been willing to pierce the veil of incorporation is that the company in question was being used by its controller in an attempt to avoid liability for some wrongdoing, including (among others) tax evasion or

¹²²³ See ECT, Art. 1(7)(a)(i) (defining a natural person "Investor" of a Contracting Party as "having the citizenship or nationality of or who is permanently residing in that Contracting Party *in accordance with its applicable law*") (emphasis added); *id.* Art. 1(7)(a)(ii) (defining an "Investor" of a Contracting Party that is a company or other organization as "*organised in accordance with the law applicable in that Contracting Party*") (emphasis added).

¹²²⁴ Expert Opinion of Andreas Michaelides §§ 17-21 (**Exhibit RF-D17**) (discussing *Republic of Cyprus through the Minister of Communications and Works v. KEM Taxi Limited*, (1987) 3 CLR 1057, 1060).

¹²²⁵ Expert Opinion of Andreas Michaelides §§ 17-21 (**Exhibit RF-D17**) (discussing *Republic of Cyprus through the Minister of Communications and Works v. KEM Taxi Limited*, (1987) 3 CLR 1057, 1060: "willing to lift the veil where the device of incorporation is used for some illegal or improper purpose.").

¹²²⁶ Expert Opinion of Andreas Michaelides §§ 12 (**Exhibit RF-D17**) (quoting *Bank of Cyprus (Holdings) Ltd. v. Republic of Cyprus through the Commissioner of Income Tax*, (1983) 3 CLR 636, 647: "have shown readiness to lift the veil whenever incorporation is used as a device to secure financial advantages or whenever the interposition of a subsidiary is inconsequential to the nature of the transaction").

fraud."¹²²⁷ He further concludes that veil-piercing is warranted here under Cypriot law because Hulley and Veteran "have not only been involved in the wrongdoing in question, but they have been incorporated in order to be used and in fact they were used as vehicles by the ultimate beneficial owners of the companies to effect and conceal the wrongdoing"¹²²⁸ – including illegal bid-rigging during the 1995-1996 Loans-for-Shares auctions and investment tenders, illegal transfers of Yukos shares to offshore jurisdictions, and abuses of the Cyprus-Russia DTA to evade Russian taxes.¹²²⁹

718. Application of Isle of Man law with respect to YUL results in the same conclusion. As in Cyprus, the Isle of Man looks to English common law for guidance on principles of corporate separateness.¹²³⁰ Accordingly, courts in the Isle of Man likewise have recognized that it is appropriate to pierce the corporate veil where a company's separate legal personality is being abused for wrongdoing. In *Logan T/A Hugh Logan Architects v. Bent Ham Ltd.*, for example, the High Court of Justice of the Isle of Man found that there are "exceptions" to corporate separateness "where the court is prepared to lift, pierce or look behind the corporate veil where for example fraud or impropriety are involved."¹²³¹ In conducting its analysis, the court relied heavily on English law, including various English Commercial Court cases demonstrating veil piercing in cases of abuse or fraud.¹²³² Similarly, in *Kakay v. Frearson*, the High Court of Justice found that it could pierce the corporate veil against a trust fund "set up with the sole intention of avoiding the Plaintiff's

¹²²⁷ Expert Opinion of Andreas Michaelides §§ 28 (**Exhibit RF-D17**): "[t]he common theme running through all the cases in which the court has been willing to pierce the veil of incorporation is that the company in question was being used by its controller in an attempt to avoid liability for some wrongdoing".

¹²²⁸ Expert Opinion of Andreas Michaelides §§ 30 (**Exhibit RF-D17**): "have not only been involved in the wrongdoing in question, but they have been incorporated in order to be used and in fact they were used as vehicles by the ultimate beneficial owners of the companies to effect and conceal the wrongdoing".

¹²²⁹ Expert Opinion of Andreas Michaelides §§ 26-35 (**Exhibit RF-D17**); see also *id.* §§ 546-554 (addressing violations of Cyprus law in connection with abuses of the Cyprus-Russia DTA).

¹²³⁰ See, e.g., *Woman v. IOTA Violet and others*, Staff of Government Division (Isle of Man Appeal Division) (Judgment of 19 Aug. 2016) §§ 38-39 (**Exhibit RF-357**) (citing the "well-established" corporate separateness principles outlined in the landmark UK case *Salomon v. Salomon* [1897] AC 22 and the recent UK Supreme Court case *Prest v. Petrodel Resources Ltd.* [2013] 2 AC 415).

¹²³¹ *Logan T/A Hugh Logan Architects v Bent Ham Ltd.*, High Court of Justice of the Isle of Man - Civil Division (Judgment of 10 Aug. 2011) § 16 (**Exhibit RF-358**): "where the court is prepared to lift, pierce or look behind the corporate veil where for example fraud or impropriety are involved".

¹²³² See, e.g., *Logan T/A Hugh Logan Architects v Bent Ham Ltd.*, High Court of Justice of the Isle of Man - Civil Division (Judgment of 10 Aug. 2011), §§ 14-19 (**Exhibit RF-358**).

creditors.”¹²³³ The court relied on the English High Court decision in *Trustor AB v. Smallbone* to find that it could pierce the veil “if the company had been used as a device or façade to conceal the true facts, thereby avoiding or concealing any liability of the individual.”¹²³⁴

(c) ***The ECT Does Not Protect HVY’s Investments Because They Were Made In Violation Of Law***

(c)(i) *The ECT, Consistent With Well-Established International Law, Does Not Protect Investments Made In Violation Of Law*

719. In the Writ, the Reply, and this Defence on Appeal, the Russian Federation has detailed the extensive evidence of the illegality in both the making and operation of HVY’s alleged investment – including as to the Russian Oligarchs’ fraudulent acquisition of the Yukos shares forming the basis for HVY’s claims.¹²³⁵ Further to the prior expansive treatment of these issues before the District Court, it is well established as a matter of international law and public policy that an investment made in violation of host State law is not entitled to the protections of an investment treaty – and, accordingly, that a tribunal does not have jurisdiction over claims arising from an illegal investment.

720. It is a fundamental principle of investment arbitration that the investment must be legal and bona fide.¹²³⁶ This principle of legality covers the “unclean hands” doctrine, which is a longstanding principle of international law and public policy. It requires that a “[p]arty who asks for redress must present himself with clean hands.”¹²³⁷ Nonetheless, HVY argue

¹²³³ *Kakay v. Frearson & other*, High Court of Justice of the Isle of Man - Common Law Division (Judgment 20 June 2008) § 35 (**Exhibit RF-359**): “set up with the sole intention of avoiding the Plaintiff’s creditors”.

¹²³⁴ *Kakay v. Frearson & other*, High Court of Justice of the Isle of Man - Common Law Division (Judgment 20 June 2008) § 35 (**Exhibit RF-359**): “if the company had been used as a device or façade to conceal the true facts, thereby avoiding or concealing any liability of the individual.”.

¹²³⁵ See, e.g., Writ, §§ 26-60; See also *id.* § 18 (explaining that “pertinent background facts” include “the Russian oligarchs’ fraudulent acquisition and consolidation of control over Yukos”); SoR, §§ 26-33; *id.* § 13 (explaining that the “Tribunal also did not have jurisdiction over the parties’ dispute, because HVY’s investments were made in breach of Russian law” and that, “[i]n light of HVY’s ‘unclean hands,’ HVY’s investments are not entitled to protection under Article 1(6) ECT”); *id.* §§ 258-273 (same); *supra* chapter III.B(a).

¹²³⁶ See also SoR, §§ 258-264.

¹²³⁷ *The Medea and The Good Return Cases* (1862), excerpted in 3 John Bassett Moore, HISTORY AND DIGEST OF THE INTERNATIONAL ARBITRATIONS TO WHICH THE UNITED STATES HAS BEEN A PARTY 2739 (1898) (R-204); see also, e.g., Ian Brownlie, PRINCIPLES OF INTERNATIONAL LAW 503 (7th ed. 2008) (describing unclean hands as a principle “according to which a claimant’s involvement in activity illegal under either municipal or international law may bar the claim”) (**Exhibit RF-70**); SoR, § 262 n. 428.

that no provision of the ECT that is “relevant to the Arbitral Tribunal’s jurisdiction contains any requirement of the legality of an investment,” and that “the legality of an investment is not a condition for the validity of an arbitration agreement under the ECT.”¹²³⁸ Within the context of investment treaty arbitration, however – as HVY surely are aware – it is well established that treaty protections do not extend to investments made in violation of host State law, even when the treaty at issue does not include a provision expressly excluding illegal investments from the scope of treaty protections.

721. For example, in the recently reported award in *Spentex v. Uzbekistan*, the tribunal dismissed the investor’s claims under the Netherlands-Uzbekistan BIT for lack of jurisdiction because the investment had been obtained through corrupt multi-million dollar payments to State officials.¹²³⁹ In *Metal-Tech v. Uzbekistan*, the tribunal likewise dismissed for lack of jurisdiction because the claimant had made millions of dollars of bribery payments in making the investment.¹²⁴⁰ Similarly, in *Inceysa v. El Salvador*, the tribunal dismissed the claims on finding that the investment was made “in a manner that was clearly illegal” – specifically, fraud in the bidding process that involved presenting false financial information and documents, and making false representations.¹²⁴¹ In *Anderson v. Costa Rica*, the tribunal dismissed the claims because the claimants made their investment through financial intermediaries which had acted in violation of government authorization requirements under host State law.¹²⁴² The tribunal in *Fraport v. Philippines II* dismissed for lack of jurisdiction because the claimant had intentionally violated nationality restrictions under host State law by making its investment through a Philippine entity

¹²³⁸ SoA, § 815.

¹²³⁹ See, e.g., Vladislav Djanic, *In newly unearthed Uzbekistan ruling, exorbitant fees promised to consultants on eve of tender process are viewed by tribunal as evidence of corruption, leading to dismissal of all claims under Dutch BIT*, in INVESTMENT ARBITRATION REPORTER (22 June 2017), available at <https://www.iareporter.com/articles/in-newly-unearthed-uzbekistan-ruling-exorbitant-fees-promised-to-consultants-on-eve-of-tender-process-are-viewed-by-tribunal-as-evidence-of-corruption-leading-to-dismissal-of-all-claims-under-dutch> (last accessed 28 Sept. 2017) (**Exhibit RF-360**). The *Spentex* award is not publicly available at this time.

¹²⁴⁰ See, e.g., *Metal-Tech Ltd. v. The Republic of Uzbekistan*, ICSID Case No. ARB/10/3, Award dated 4 Oct. 2013, §§ 373, 389 (**Exhibit RF-361**). The BIT at issue in *Metal-Tech* did include a legality clause.

¹²⁴¹ *Inceysa Vallisoletana, S.L. v. Republic of El Salvador*, ICSID Case No. ARB/03/26, Award dated 2 Aug. 2006, §§ 236, 239, 243-244, 257 (RME-1083); see also SoR, § 263 (discussing *Inceysa*).

¹²⁴² *Alasdair Ross Anderson v. Republic of Costa Rica*, ICSID Case No. ARB(AF)/07/3, Award dated 19 May 2010, § 55 (RME-4204); see also *id.* § 59 (“[T]he Claimants did not own or control investments in accordance with the law of Costa Rica.”); see also SoR, § 264 n.431 (discussing *Anderson*).

which it created, managed, controlled, and funded.¹²⁴³ Many other tribunals have recognized that investments made in violation of host State law are not subject to investment treaty protection – including where the treaty does not contain an express legality requirement.¹²⁴⁴

722. The approach of several tribunals in cases under the ECT has been consistent with this large body of jurisprudence, notwithstanding the absence of an express legality provision in the ECT. In *Mamidoil v. Albania*, for example, the tribunal held that it “shares the widely-held opinion that investments are protected by international law only when they are made in accordance with the legislation of the host State,” and that States “cannot be expected to

¹²⁴³ *Fraport AG Frankfurt Airport Services Worldwide v. Republic of the Philippines*, ICSID Case No. ARB/11/12, Award dated 10 Dec. 2014, §§ 355-357, 467 (**Exhibit RF-147**); see also SoR, § 261 (discussing *Fraport*).

¹²⁴⁴ See, e.g., *SAUR International S.A. v. Argentine Republic*, ICSID Case No. ARB/04/4, Decision on Jurisdiction and Liability dated 6 June 2012 § 308 (finding that “the condition of not committing a serious violation of the legal order is a *tacit* condition, inherent to any [treaty]”) (unofficial translation by counsel) (RME-4186); SoR, § 259 (discussing *SAUR*); *Ampal-American Israel Corporation and others v. Arab Republic of Egypt*, ICSID Case No. ARB/12/11, Decision on Jurisdiction dated 1 Feb. 2016, § 301 (**Exhibit RF-362**) (upholding defense raised by Respondent, represented in the proceeding by HVY’s international counsel, and ruling that “[i]t is a well-established principle of international law that a tribunal constituted on the basis of an investment treaty has no jurisdiction over a claimant’s investment which was made illegally in violation of the laws and regulations of the Contracting State.”); *David Minnotte and Robert Lewis v. Republic of Poland*, ICSID Case No. ARB(AF)/10/1, Award dated 16 May 2014, § 132 (**Exhibit RF-363**) (finding that jurisdiction should be denied where fraud is manifest and connected to the making of the investment); *Oxus Gold plc v. The Republic of Uzbekistan*, UNCITRAL, Final Awards dated 17 Dec. 2015, §§ 706-707 (**Exhibit RF-364**) (ruling that the treaty does not protect illegal investments where “the illegality affects the ‘making’ of the investment”); *Ioannis Kardassopoulos v. Georgia*, ICSID Case No. ARB/05/18, Decision on Jurisdiction dated 6 July 2007, § 182 (confirming that treaty protections do not extend to investors making an investment in breach of domestic laws) (R-886) (RME-994); see also *World Duty Free Company Limited v. The Republic of Kenya*, ICSID Case No. ARB/00/7, Award dated 4 Oct. 2006, §§ 118, 178-179 (**Exhibit RF-365**) (concluding that the Claimant’s bribe made the investment illegal and that “[c]laims founded on illegality have to be dismissed for the benefit of the public . . .”); *Société d’Investigation de Recherche et d’Exploitation Minière (SIREXM) v. Burkina Faso*, ICSID Case No. ARB/97/1, Award dated 19 Jan. 2000, (Extracts) § 6.33 (**Exhibit RF-366**) (concluding that it would be “shocking to see the Claimant, whose conduct is tainted with fraud, obtaining compensation”) (unofficial translation by counsel); *Teinver S.A., Transportes de Cercanías S.A. and Autobuses Urbanos del Sur S.A. v. The Argentine Republic*, ICSID Case No. ARB/09/1, Decision on Jurisdiction dated 21 Dec. 2012, § 257 (**Exhibit RF-367**) (requiring the investment to be “legally acquired” for it to be protected under the treaty); *Gustav F W Hamester GmbH & Co KG v. Republic of Ghana*, ICSID Case No. ARB/07/24, Award dated 18 June 2010, §§ 123-124 (**Exhibit RF-368**) (determining that “[a]n investment will not be protected if it has been created in violation of national or international principles of good faith; by way of corruption, fraud, or deceitful conduct; or if its creation itself constitutes a misuse of the system of international investment protection . . .”); *Phoenix Action, Ltd. v. Czech Republic*, ICSID Case No. ARB/06/5, Award dated 15 Apr. 2009, § 101 (determining that “[the condition of] the conformity of the establishment of the investment with the national laws . . . is implicit even when not expressly stated in the relevant [treaty]”) (RME-1078); Carmen Martínez López & Lucy Martínez, *Corruption, Fraud and Abuse of Process in Investment Treaty Arbitration*, in *THE INVESTMENT TREATY ARBITRATION REVIEW* (2017), at 144, 148 (**Exhibit RF-369**) (noting that “[t]o date, at least eight tribunals have dismissed investor-state claims on the basis of fraud, illegality, misrepresentation or breach of good faith”).

have agreed to extend [their consent to arbitrate] to investments that violate their laws.”¹²⁴⁵ In *Blusun v. Italy*, the tribunal affirmed that the ECT “does not cover investments which are actually unlawful under the law of the host state at the time they were made because protection of such investments would be contrary to the international public order.”¹²⁴⁶ And in the oft-cited *Plama v. Bulgaria*, where the claimant had committed fraud in the making of its investment, the tribunal held that “the substantive protections of the ECT cannot apply to investments that are made contrary to law.”¹²⁴⁷ Indeed, the Tribunal in this case reached the same conclusion:

The Tribunal agrees with this proposition. In imposing obligations on States to treat investor in a fair and transparent fashion, investment treaties seek to encourage legal and *bona fide* investments. An investor who has obtained an investment in the host State only by acting in bad faith or in violation of the laws of the host state, has brought itself within the scope of application of the ECT through wrongful acts. Such an investor should not be allowed to benefit from the Treaty.¹²⁴⁸

723. Even when denying that illegality in the making of an investment can be a jurisdictional ground for dismissal under the ECT (and thus ignoring the weight of authority and the holding of the Tribunal in this case), HVY also argue (in the very next paragraph of their Statement of Appeal) that “the protection of the ECT could only be withheld for investments, the making as opposed to the later performance of which is unlawful.”¹²⁴⁹ This uncontroversial proposition simply restates the extensive body of law detailed immediately above. HVY further suggest, however, that the pervasive illegality in the Russian Oligarchs’ acquisition of the Yukos shares does not “relate[] to the actual making of an investment by HVY, i.e., their acquisition of Yukos shares between 1999 and

¹²⁴⁵ *Mamidoil Jetoil Greek Petroleum Products Societe S.A. v. Republic of Albania*, ICSID Case No. ARB/11/24, Award dated 30 Mar. 2015 § 359 (**Exhibit RF-370**): “shares the widely-held opinion that investments are protected by international law only when they are made in accordance with the legislation of the host State.”.

¹²⁴⁶ *Blusun S.A., Jean-Pierre Lecorcier and Michael Stein v. Italian Republic*, ICSID Case No. ARB/14/3, Award dated 27 Dec. 2016 § 264 (**Exhibit RF-371**): “does not cover investments which are actually unlawful under the law of the host state at the time they were made because protection of such investments would be contrary to the international public order.”.

¹²⁴⁷ *Plama Consortium Limited v. Republic of Bulgaria*, ICSID Case No. ARB/03/24, Award dated 27 Aug. 2008 § 139 (Annex (Merits) C-994): “the substantive protections of the ECT cannot apply to investments that are made contrary to law.”; see also SoR, § 260 (discussing *Plama*).

¹²⁴⁸ Final Awards, marginal nos. 1351-1352.

¹²⁴⁹ SoA, § 816.

2001.”¹²⁵⁰ This argument, too, is unfounded – and already rejected by the Tribunal. Indeed, the Tribunal held that it “agrees with Respondent that an examination of the legality of an investment should not be limited to verifying whether the last in a series of transactions leading up to the investment was in conformity with the law. The making of the investment will often consist of several consecutive acts and all of these must be legal and *bona fide*.”¹²⁵¹

(c)(ii) *HVY Acquired Their Investments In Yukos Through Widespread Violations Of Law*

724. The legal predicate under the ECT and international law to dismiss HVY’s claims on jurisdictional grounds due to illegality in the making of the investment is thus well established. Nonetheless, the Tribunal ultimately found as a factual matter that any illegality in the Russian Oligarchs’ Yukos share acquisition was not “sufficiently connected with the final transaction” by HVY.¹²⁵² This finding was fundamentally and fatally flawed, as established both by evidence in the arbitral record and by further evidence (concealed by HVY) that has since come to light. Indeed, as detailed above, the Russian Oligarchs obtained HVY’s Yukos shares by fraud and collusion which was facilitated by paying bribes through YUL to public officials.¹²⁵³ Further, 100% of the Yukos shares underlying HVY’s claims in the ECT arbitrations originated with the Russian Oligarchs’ illegal activities in 1995 and 1996.¹²⁵⁴

725. While avoiding unnecessary repetition of the factual details addressed comprehensively above,¹²⁵⁵ the Russian Federation focuses here on rebutting specific findings by the Tribunal and contentions by HVY that are directly contradicted by the extensive evidence confirming that HVY acquired their shares in Yukos through widespread violations of law.

(c)(ii)(i) *HVY Were Directly Involved In The Illegal Acquisition Of Yukos Shares*

¹²⁵⁰ SoA, § 816.

¹²⁵¹ Final Awards, marginal no. 1369.

¹²⁵² Final Awards, marginal no. 1370.

¹²⁵³ *See supra* chapter III.B.

¹²⁵⁴ First Kothari Report (**Exhibit RF-202**), § 45; Second Kothari Report (**Exhibit RF-D15**), § 83.

¹²⁵⁵ *See supra* chapter III.

726. Significantly, as reflected in paragraphs 1368-1370 of the Final Awards, the arbitral Tribunal did not make any findings at all with respect to the Russian Federation's contention that the YUKOS privatization was illegally manipulated through fraud, collusive bidding, and bribery. Rather, the Tribunal stopped short of assessing these illegal activities on the basis that "[t]hey involved Bank Menatep and the Oligarchs, an entity and persons separate from Claimants, one of which—Veteran—had not yet come into existence."¹²⁵⁶ The Tribunal's reasoning on the issue of HVY's allegedly "separate" status is incorrect for several distinct reasons.¹²⁵⁷
727. First, *YUL itself* was the entity that paid the bribes to the Red Directors on the Russian Oligarchs' behalf, as reflected in YUL's bank accounts and the text of the relevant sham agreements.¹²⁵⁸ The ECT Tribunal members were well aware of this fact—they even recorded it several different times in the text of the Final Awards.¹²⁵⁹ But the Tribunal never considered the legal consequences of this fact, and never explained how this fact could possibly be reconciled with their conclusion that YUL was not itself directly involved in the manipulation of the YUKOS privatization. This reflects a manifest failure to address and apply the relevant evidence.
728. Second, the Russian Oligarchs have expressly admitted responsibility for YUL's payments to the Red Directors in at least three different statements made after the conclusion of the arbitrations in July 2014, and indeed after the District Court's judgment in April 2016. These statements are reflected in Mr. Dubov's 2017 witness declaration, a 2016 Facebook post by Mr. Khodorkovsky, and a 2016 open letter to the *American Lawyer* by the CEO of GML, Mr. Timothy Osborne.¹²⁶⁰ These repeated and consistent statements confirm that YUL's payments were made on the Russian Oligarchs' behalf, at the Russian Oligarchs'

¹²⁵⁶ Final Awards, marginal no. 1370.

¹²⁵⁷ *See supra* chapter III.C.

¹²⁵⁸ Account Statements of Yukos Universal Limited from UBS Zurich (*See* Expert Opinion of Prof. Pieth, MP-066); Original Agreement between Group Menatep Limited, Beneficiaries, and Tempo Finance Ltd. dated 26 Mar. 2002 (*See* Expert Opinion of Prof. Pieth, MP-067); Amended and Restated Compensation Agreement between Group Menatep Limited, Beneficiaries, and Tempo Finance Ltd. dated 1 Nov. 2002 (*See* Expert Opinion of Prof. Pieth, MP-075).

¹²⁵⁹ Final Awards, marginal nos. 1243, 1283(v).

¹²⁶⁰ Witness Statement of Dubov dated 13 Mar. 2017 (Pieth Annex F); Mikhail Khodorkovsky's Facebook Post dated 9 June 2016 (*See* Expert Opinion of Prof. Pieth, MP-139); Letter from Tim Osborne to *American Lawyer* dated 5 Aug. 2016 (*See* Expert Opinion of Prof. Pieth, MP-113).

instructions, and in fulfilment of the Russian Oligarchs’ “verbal promise”¹²⁶¹ during the YUKOS privatization. Accordingly, even if the ECT Tribunal’s finding regarding the supposed legal separateness of YUL had been legally defensible in 2014 (which it was not), then these findings must now be reassessed by this Court based on the three public statements in 2016 and 2017.

729. Third, as demonstrated by Professor Kothari’s meticulous forensic analysis, 100% of the YUKOS shares underlying HVY’s claims in the ECT arbitrations originated with the Russian Oligarchs’ illegal activities in 1995 and 1996 – notwithstanding the complex web of transactions that the Russian Oligarchs and HVY interposed in effort to conceal that critical fact.¹²⁶² Unable to dispute this evidence, HVY now suggest that it was never even concealed.¹²⁶³ Significantly, as the Tribunal itself found as a matter of international law, “an examination of the legality of an investment should not be limited to verifying whether the last in a series of transactions leading up to the investment was in conformity with the law. The making of the investment will often consist of several consecutive acts and all of these must be legal and *bona fide*.”¹²⁶⁴ Professor Pieth confirms that this is also the case with respect to transnational rules governing money laundering under multilateral treaties, as well as under the domestic statutes of both the Russian Federation and the Netherlands.¹²⁶⁵
730. Tellingly, HVY offer no substantive response to Professor Kothari’s forensic analysis of the Yukos share registry. Instead, they seek to distract through baseless arguments that the Russian Federation is “guilty of misleading the court” and “procedural fraud”¹²⁶⁶ because

¹²⁶¹ Second Prof. Pieth Report (**Exhibit RF-D14**), §§ 19-26; Mikhail Khodorkovsky's Facebook Post dated 9 June 2016 (*See* Expert Opinon of Prof. Pieth, MP-139).

¹²⁶² First Kothari Report (**Exhibit RF-202**), § 45; Second Kothari Report (**Exhibit RF-D15**), § 83.

¹²⁶³ SoA, § 837.

¹²⁶⁴ Final Awards, marginal no. 1369.

¹²⁶⁵ Second Prof. Pieth Report (**Exhibit RF-D14**), § 63; OECD Working Group Phase 1 Report on Implementing the OECD Anti-Bribery Convention in the Russian Federation dated 16 Mar. 2012 (*See* Expert Opinon of Prof. Pieth, MP-184) § A.7 (Arts. 174, 174.1, and 175 of the Russian Criminal Code apply to money laundering); OECD Working Group Phase 2 Report on the Application of the Convention on Combating Bribery of Foreign Public Officials in International Business Transactions and the 1997 Recommendations on Combating Bribery in International Business Transactions in the Netherlands dated 15 June 2006 (*See* Expert Opinon of Prof. Pieth, MP-180) § C.8 (Article 420 of the Dutch Penal Code applies to money laundering); OECD Working Group Phase 3 Report on Implementing the OECD Anti-Bribery Convention in the Netherlands dated 14 Dec. 2012 (*See* Expert Opinon of Prof. Pieth, MP-186) § B.6(a) (confirming Article 420 still applies).

¹²⁶⁶ *See, e.g.*, SoA, §§ 836, 847.

counsel explained during oral argument that the share registry had been “in code” and thus inaccessible until October 2015.¹²⁶⁷ According to HVY, the shareholder registry data was “fully accessible, without any encryption.”¹²⁶⁸ To be clear, counsel for the Russian Federation used the word “coded” and did not argue that the data was “encrypted”; HVY’s arguments to that effect are irrelevant. In addition, Colonel of Justice Mikhailov, the Head of the Investigation Section of the Main Investigation Department of the Investigative Committee of the Russian Federation, has testified that, during the Yukos criminal investigation, investigators did not have the technical capabilities or necessary equipment to access the Yukos share registry, which had been maintained through a sophisticated software program.¹²⁶⁹ It was not until October 2015, when Colonel Mikhailov tracked down one of the original authors of the software, that investigators first gained access to the electronic share registry.¹²⁷⁰ Counsel’s explanation at oral argument before the District Court is consistent with these events.

731. Further, Professor Kothari explains in his second expert report that, as a matter of forensic accounting, digital encryption is not the only means of “encoding” information. In fact, there are “numerous methods” to “disguise and conceal” financial transactions, “such that the underlying movements of funds or assets cannot be deciphered or ‘readily accessed’ without considerable effort and detailed analysis.”¹²⁷¹ In the case of the Yukos registry, Professor Kothari concludes, HVY’s principals relied on at least two different methods – the use of nominal holders and the use of structured transactions (or “smurfing”) – to “disguise[] the names of the actual owners and obscure[] the underlying transfers of shares, such that the information in the YUKOS share registry was effectively encoded.”¹²⁷² Given these efforts to conceal the nature of their illegal activities, HVY’s claim that the Russian Federation has somehow been “guilty of deception” with respect to the Yukos share registry is entirely without merit and , in bad faith.

¹²⁶⁷ SoA, § 847.

¹²⁶⁸ SoA, § 847.

¹²⁶⁹ Declaration of Colonel of Justice S.A. Mikhailov (**Exhibit RF-G4**), § 13.

¹²⁷⁰ Declaration of Colonel of Justice S.A. Mikhailov (**Exhibit RF-G4**), § 15.

¹²⁷¹ English original: “*numerous methods [to] disguise and conceal [financial transactions], such that the underlying movements of funds or assets cannot be deciphered or ‘readily accessed’ without considerable effort and detailed analysis.*” Second Expert Report of Prof. Kothari (**Exhibit RF-D15**), § 14.

¹²⁷² English original: “*disguise (...) the names of the actual owners and obscure (...) the underlying transfers of shares, such that the information in the Yukos share registry was effectively encoded.*” Second Expert Report of Prof. Kothari (**Exhibit RF-D15**), § 15.

732. Accordingly, the ECT Tribunal's conclusions with respect to the purported juridical separateness of HVY and the Russian Oligarchs are unsustainable. HVY's misrepresentations to the same effect before this Court¹²⁷³ (and the District Court¹²⁷⁴) likewise must be rejected for the same reasons.

(c)(ii)(ii) *Certain Details Of The YUKOS Privatization Were Public Knowledge – And Expressly Condemned By The State Duma – While Other Details Remained Concealed By The Russian Oligarchs*

733. In their Statement of Appeal, HVY argue that “the Russian Federation had never contested the alleged illegal acts” pertaining to the YUKOS privatization,¹²⁷⁵ even though some of the relevant details were “a matter of public knowledge.”¹²⁷⁶ In support, HVY cite to a series of contemporaneous newspaper articles from *The Moscow Times*, *The Wall Street Journal*, and *Kommersant*, which reflect that certain details about the collusive nature of the YUKOS privatization were publicly known in December 1995.¹²⁷⁷ In other words, HVY are not even attempting to argue that the YUKOS privatization was truly *competitive*. Instead, HVY are arguing that the *collusive* way of the YUKOS privatization must have been *legal*, because a notoriously criminal act supposedly cannot have gone unprosecuted for so many years. This argument is meritless for a number of reasons.

734. First, even if some aspects of the YUKOS privatization were immediately known in December 1995, other significant aspects were carefully concealed by the Russian Oligarchs:

For example, in December 1996, the Oligarchs' agents told public falsehoods regarding their connection with ZAO Monblan. As reflected in contemporaneous newspaper accounts, Mr. Kagalovsky asserted that “[t]here

¹²⁷³ See, e.g., SoA, § 733 (claiming that “HVY are ultimately owned and controlled by trustees under the laws of the United Kingdom”).

¹²⁷⁴ See, e.g., Pleading Notes HVY, § 16 (claiming that HVY are “not indirectly owned and controlled by Russian individuals but (ultimately) by the respective trustees. These trustees are nationals of the United Kingdom, not of Russia (...).”) & § 79 (“[Accordingly,] the trustees, rather than the [Russian] beneficiaries, are the owners of and control the assets of the trusts.”).

¹²⁷⁵ SoA, § 828.

¹²⁷⁶ SoA, § 837.

¹²⁷⁷ See *Kommersant*, “Menatep won the competition with itself”, 9 December 1995 (Exhibit HVY-194); *The Moscow Times*, “Yukos Winner backed by Menatep”, 9 December 1995 (Exhibit HVY-195); Transcript of YUKOS – Inner Empire, RUSSIA 24, <http://www.vesti.ru/videos/show/vid/704645/>, retrieved 23 January 2017, p. 6 (Exhibit HVY-196); *Wall Street Journal*, “Banks win Russian Oil Stake”, 11 December 1995 (Exhibit HVY-197).

is no connection between Monblan and Menatep.¹²⁷⁸ Bank Menatep's spokeswoman, Ms. Natalya Mandrova, also reportedly 'denied Menatep had any connection with Monblan.'¹²⁷⁹ This is now admitted to be a false statement, and neither Mr. Dubov nor Professor Rebut [HVY's expert in French proceedings] provide any legitimate explanation for this deception. Similarly, none of the 1995 newspaper accounts cited by Professor Rebut – including *Le Monde*, *Moscow Times*, and the *Wall Street Journal* – provide any evidence that the Oligarchs' promise to pay 'a significant financial interest'¹²⁸⁰ to the Red Directors was known to the public or to the Russian authorities.¹²⁸¹

735. Second, none of HVY's newspaper accounts addressing the rumors about the collusive way of the YUKOS privatization suggest that it was lawful. To the contrary, as Professor Pieth observes, these newspaper accounts consistently confirm the widespread rumors that the YUKOS privatization had been corruptly and collusively manipulated:

As reported by *Moscow Times* in December 1995: 'The loans-for-shares program which started last month has been plagued by scandal 'It is just a trick to give the block to the previously chosen company,' said a Western analyst, who declined to be named.'¹²⁸² Similarly, *Reuters* reported that 'Critics accused the cash-strapped government of selling strategically important stakes at absurdly low prices.'¹²⁸³ During subsequent years, this view was confirmed by respected international economists, who had advised the Government of the Russian Federation regarding economic policy in the Russian Federation. The Nobel Prize winner, Professor Joseph Stiglitz, described the 1995 'Loans for Shares' privatizations as 'grand larceny.'¹²⁸⁴

¹²⁷⁸ Sergey Lukyanov, *'Managed' Yukos Sale Fetches \$160M*, in MOSCOW TIMES, dated 24 Dec. 1996 (See Expert Opinon of Prof. Pieth, MP-035), at 1: "[t]here is no connection between Monblan and Menatep."

¹²⁷⁹ Sergey Lukyanov, *'Managed' Yukos Sale Fetches \$160M*, in MOSCOW TIMES, dated 24 Dec. 1996 (See Expert Opinon of Prof. Pieth, MP-035), at 2: "denied Menatep had any connection with Monblan."

¹²⁸⁰ Memorandum from Doug Miller to Bruce Misamore dated 14 Aug. 2002 (See Expert Opinon of Prof. Pieth, MP-071), at 3: "a significant financial interest".

¹²⁸¹ Second Prof. Pieth Report § 92 (**Exhibit RF-D14**): "For example, in December 1996, the Oligarchs' agents told public falsehoods regarding their connection with ZAO Monblan. As reflected in contemporaneous newspaper accounts, Mr. Kagalovsky asserted that '[t]here is no connection between Monblan and Menatep.' Bank Menatep's spokeswoman, Ms. Natalya Mandrova, also reportedly 'denied Menatep had any connection with Monblan.' This is now admitted to be a false statement, and neither Mr. Dubov nor Professor Rebut [HVY's expert] provide any legitimate explanation for this deception. Similarly, none of the 1995 newspaper accounts cited by Professor Rebut [HVY's expert] - including *Le Monde*, *Moscow Times*, and the *Wall Street Journal* - provide any evidence that the Oligarchs' promise to pay 'a significant financial interest' to the Red Directors was known to the public or to the Russian authorities."

¹²⁸² *Auctions End on Contentious Note*, *Moscow Times*, dated 29 Dec. 1995 (See Expert Opinon of Prof. Pieth, MP-151), at 2.

¹²⁸³ *Unknown Monblan Wins Third of Russia's YUKOS*, *Reuters*, dated 23 Dec. 1996 (See Expert Opinon of Prof. Pieth, MP-153).

¹²⁸⁴ Interview with Joseph Stiglitz, *Progressive.org* for 16 June 2000 (See Expert Opinon of Prof. Pieth, MP-

Similarly, Professor Jeffrey Sachs described these privatizations as ‘blatantly corrupt from the start.’¹²⁸⁵ Accordingly, whatever ‘public notoriety’ may have emerged regarding the relationship between Bank Menatep and the bidders participating in the YUKOS privatization, this reputation hardly points toward the Oligarchs’ innocence.’¹²⁸⁶

736. Third, HVY’s assertions that the Russian Federation remained silent about the Russian Oligarchs’ actions are demonstrably false. In fact, the State Duma of the Russian Federation expressly and contemporaneously condemned the illegal manipulation of the YUKOS privatization:

Specifically, the State Duma enacted Resolution No. 3331-II on 4 December 1998, reflecting the national legislature’s conclusion that many of the Loans-for-Shares auctions were sham transactions concealing collusion. As explained in Resolution No. 3331-II, ‘by turns, the same legal entities, which allowed them to co-ordinate their actions in advance in order to acquire blocks of shares at a marked-down price.’¹²⁸⁷ On this basis, the State Duma implored the President and the Government to initiate legal proceedings to invalidate the YUKOS privatization and other similar transactions.¹²⁸⁸

737. Fourth, HVY’s claim that the Russian Federation has purportedly “forfeited” the right to raise HVY’s illegality in this proceeding because it has not taken “legal action” in Russia¹²⁸⁹ likewise is without merit. In fact, Colonel of Justice Mikhailov has testified that

175), at 6.

¹²⁸⁵ Jeff Sachs, *What I did in Russia*, dated 14 Mar. 2012 (See Expert Opinion of Prof. Pieth, MP-183), at 15.

¹²⁸⁶ Second Prof. Pieth Report § 93 (**Exhibit RF-D14**): “As reported by Moscow Times in December 1995: ‘The loans-for-shares program which started last month has been plagued by scandal ‘It is just a trick to give the block to the previously chosen company,’ said a Western analyst, who declined to be named.’ Similarly, Reuters reported that ‘Critics accused the cash-strapped government of selling strategically important stakes at absurdly low prices.’ During subsequent years, this view was confirmed by respected international economists, who had advised the Government of the Russian Federation regarding economic policy in the Russian Federation. The Nobel Prize winner, Professor Joseph Stiglitz, described the 1995 ‘Loans for Shares’ privatizations as ‘grand larceny.’ Similarly, Professor Jeffrey Sachs described these privatizations as ‘blatantly corrupt from the start.’ Accordingly, whatever ‘public notoriety’ may have emerged regarding the relationship between Bank Menatep and the bidders participating in the YUKOS privatization, this reputation hardly points toward the Oligarchs’ innocence.”.

¹²⁸⁷ Resolution of the State Duma of the Federal Assembly of the Russian Federation. No. 3331-II-GD, Dec. 4, 1998 (Russian original with English translation) (R-19).

¹²⁸⁸ Second Prof. Pieth Report § 94 (**Exhibit RF-D14**): “Specifically, the State Duma enacted Resolution No. 3331-II on 4 December 1998, reflecting the national legislature’s conclusion that many of the Loans-for-Shares auctions were sham transactions concealing collusion. As explained in Resolution No. 3331-II, ‘by turns, the same legal entities, which allowed them to co-ordinate their actions in advance in order to acquire blocks of shares at a marked-down price.’ On this basis, the State Duma implored the President and the Government to initiate legal proceedings to invalidate the YUKOS privatization and other similar transactions.”

¹²⁸⁹ SoA, § 828.

the Investigative Committee issued a formal resolution in December 2016 to institute criminal proceedings based on money-laundering offenses committed as part of, and further to, the illegal manipulation of the privatization of Yukos in 1995 and 1996.¹²⁹⁰ Those criminal proceedings are ongoing.¹²⁹¹ In any event, as a matter of practice across various jurisdictions and also under Dutch law¹²⁹², even the absence of prosecution is not dispositive evidence with respect to whether criminal conduct did or did not occur. As Professor Pieth explains:

[T]he decision to prosecute or not prosecute specific instances of criminal conduct is influenced by a wide variety of factors, in accordance with the principle of prosecutorial discretion. Significantly, this principle has been endorsed by the Committee of Ministers for the Council of Europe in its Recommendation No. R (87) 18,¹²⁹³ and is reflected in Article 5 of the OECD Anti-Bribery Convention.¹²⁹⁴ As a matter of international practice, therefore, it is generally left to the discretion of a particular State's authorities to determine whether a particular crime should be prosecuted depending on the available resources, the accessibility of evidence, and other broader issues pertaining to social policy and prosecutorial strategy. Even in States with the so-called legality principle, factual discretion exists.¹²⁹⁵

738. Indeed, it is bizarre for the Russian Oligarchs to complain about the *absence* of prosecution for manipulating the YUKOS privatization, when their entire case throughout the ECT

¹²⁹⁰ Declaration of Colonel of Justice S.A. Mikhailov (**Exhibit RF-G4**), §§ 3, 7.

¹²⁹¹ Declaration of Colonel of Justice S.A. Mikhailov (**Exhibit RF-G4**), §§ 2-7.

¹²⁹² Under Dutch law, the decision not to prosecute for fraud does not prejudice a party's right to put forward fraud as a defence in civil proceedings. The Public Prosecution Service considers the expediency of each case, and frequently decides against prosecution even where it would be possible to prove an offence. For example, the Public Prosecution Service might decide not to prosecute if the offence is already being addressed in civil proceedings and if the consequences of the offence might be cancelled out or averted by the judgment in those proceedings.

¹²⁹³ Council of Europe, Committee of Ministers Recommendation No. R (87) 18 of the Committee of Ministers to member States Concerning the Simplification of Criminal Justice (1987) (*See* Expert Opinion of Prof. Pieth, MP-133).

¹²⁹⁴ OECD Convention on Combating Bribery of Foreign Public Officials in International Business Transactions (*See* Expert Opinion of Prof. Pieth, MP-098), Art. 5.

¹²⁹⁵ Second Prof. Pieth Report (**Exhibit RF-D14**), § 95: "*[T]he decision to prosecute or not prosecute specific instances of criminal conduct is influenced by a wide variety of factors, in accordance with the principle of prosecutorial discretion. Significantly, this principle has been endorsed by the Committee of Ministers for the Council of Europe in its Recommendation No. R (87) 18, and is reflected in Article 5 of the OECD Anti-Bribery Convention. As a matter of international practice, therefore, it is generally left to the discretion of a particular State's authorities to determine whether a particular crime should be prosecuted depending on the available resources, the accessibility of evidence, and other broader issues pertaining to social policy and prosecutorial strategy. Even in States with the so-called legality principle, factual discretion exists.*".

arbitrations was that the Russian Oligarchs' tax-related offenses had been prosecuted *too aggressively*.

739. As a matter of prosecutorial practice around the world, it is well known that prosecutors may choose to pursue “only those very few charges which are the easiest to prosecute,” such as tax-related offenses¹²⁹⁶ or immigration-related offenses,¹²⁹⁷ even when the accused is suspected of much more serious crimes. Under such circumstances, the prosecutors' charges need not be “fully reflective of the extent of a defendant's criminal activity,” although the accused persons certainly may find themselves “prosecuted . . . more intensely than a run-of-the-mill tax cheat.”¹²⁹⁸ A former Attorney General of the United States, Mr. John Ashcroft, for example, has expressly confirmed that it is accepted prosecutorial practice to prosecute minor offenses more aggressively where the accused person is suspected of more serious crimes.¹²⁹⁹
740. For purposes of this Award set-aside proceeding, moreover, it is a fundamental distinction that the prosecutorial analysis with respect to charges in domestic court proceedings under local law is an entirely separate inquiry from objections to the jurisdiction of an international arbitral tribunal under the ECT and international law. Indeed, a number of tribunals have confirmed that investor claims in arbitration under an investment treaty must be dismissed as a matter of international law due to illegality in the making of the investment – even where the respondent State, in its sovereign discretion, has not prosecuted the illegality in question under its laws.¹³⁰⁰

¹²⁹⁶ Cecile Aptel, Prosecutorial Discretion at the ICC and Victims' Right to Remedy: Narrowing the Impunity Gap, 10 J. Int'l Crim. Just. 1357, 1376 (2012) (**Exhibit RF-372**).

¹²⁹⁷ 2001-10-25 - Ashcroft Remarks on Prosecutorial Discretion (**Exhibit RF-373**).

¹²⁹⁸ Thomas E. Zeno, A Prosecutor's View of the Sentencing Guidelines, 55 Fed. Probation 31, 37 (1991) (**Exhibit RF-374**): “*only those very few charges which are the easiest to prosecute*”, “*fully reflective of the extent of a defendant's criminal activity*,” and “*prosecuted . . . more intensely than a run-of-the-mill tax cheat*”.

¹²⁹⁹ Remarks of John Ashcroft on Prosecutorial Discretion dated 25 October 2001 (**Exhibit RF-373**).

¹³⁰⁰ See, e.g., *World Duty Free Co. Ltd. v. Republic of Kenya*, ICSID Case No. ARB/00/7, Award dated 4 Oct. 2006, §§ 157, 179-180 (**Exhibit RF-365**) (dismissing claims as a matter of public policy under international and national law due to claimant's bribery payments to the president, notwithstanding the absence of prosecution for president's corruption); *Fraport v. Philippines II*, ICSID Case No. ARB/11/12, Award dated 10 Dec. 2014, §§ 385-386, 467-468 (**Exhibit RF-375**) (dismissing claims for lack of jurisdiction due to violation of Anti-Dummy Law imposing nationality restrictions, notwithstanding claimant's arguments that the violation in question was “alleged only in this arbitration” and had “never been pursued domestically”); *Metal-Tech Ltd. v. Republic of Uzbekistan*, ICSID Case No. ARB/10/3, Award dated 4 Oct. 2013, §§ 336, 372-373 (**Exhibit RF-361**) (dismissing claims for lack of jurisdiction

741. For these reasons, therefore, the absence of prosecution with respect to the Russian Oligarchs' illegal manipulation of the YUKOS privatization cannot be interpreted as evidence of the Russian Oligarchs' innocence.

(c)(ii)(iii) *The 1996 And 2005 Commercial Court Judgments Did Not Evaluate Any Issues Of Bribery Or Collusive Bid-Rigging*

742. HVY argue that the Russian Oligarchs' illegal collusion during the YUKOS privatization is disproven based on four judgments of the Moscow Commercial [Arbitrazh] Court, rendered in 1996 and 2005.¹³⁰¹ They go so far as to claim that the judgments represent "crucial evidence" which the Russian Federation has "withheld."¹³⁰² HVY's arguments, however, ignore the actual grounds upon which these four judgments were rendered, and are therefore manifestly without merit. Indeed, a review of these four judgments demonstrates – contrary to HVY's mischaracterizations – that they were decided on procedural issues, and did not address any of the substantive arguments made by the Russian Federation in the present proceedings with respect to criminal fraud, collusive bid-rigging, or bribery.

743. First, as Professor Pieth observes, none of the issues pertaining to corruption and bribery were addressed at all in the 1996 judgments or the 2005 judgment.¹³⁰³ Neither the Moscow Commercial [Arbitrazh] Court nor the plaintiffs in these cases were aware of the Russian Oligarchs' promises to the Red Directors, or the payment of bribes worth US\$ 614 million through offshore companies under sham contracts.¹³⁰⁴

744. Second, with respect to the single judgment rendered in 2005, the Moscow Commercial [Arbitrazh] Court rejected the plaintiff's application on two grounds which are irrelevant to the concerns of the present case. Specifically, as the judgment explains, the plaintiff (OOO Rusatommet) had no legal interest in the outcome of the YUKOS privatization, and had

due to bribery in the investment, despite claimant's argument that no official had been charged with unlawful conduct in connection with its project).

¹³⁰¹ SoA, §§ 829-834.

¹³⁰² SoA, § 829.

¹³⁰³ Second Prof. Pieth Report §§ 86-89 (**Exhibit RF-D14**).

¹³⁰⁴ Judgment of the Moscow Arbitrazh Court of 28 March 1996 (Exhibit HVY-186); Ruling in appeal of the Moscow Arbitrazh Court of 30 May 1996 (Exhibit HVY-187); Ruling in cassation of the Moscow Federal Arbitrazh Court of 24 July 1996 (Exhibit HVY-188); Court Decision of the Moscow Arbitrazh Court of 28 September 2005 (Exhibit HVY-189).

missed the deadline applicable under the civil statute of limitations.¹³⁰⁵ In the 2005 case, therefore, the Moscow Commercial [Arbitrazh Court] did not make any findings whatsoever as to substantive legal issues. The Court certainly did not address whether the Russian Oligarchs had acted criminally by collusively manipulating the YUKOS privatization or bribing the Red Directors.¹³⁰⁶

745. Third, with respect to the three judgments rendered in 1996, the Moscow Commercial [Arbitrazh] Court rejected the claims of the plaintiff (AOOT Babayevskoye) because this entity had failed to submit the proper paperwork during the YUKOS privatization.¹³⁰⁷ Accordingly, the Moscow Commercial [Arbitrazh] Court concluded that this plaintiff also had no legal interest in the outcome of the YUKOS privatization, much like the 2005 plaintiff.¹³⁰⁸
746. Fourth, the three 1996 judgments show that none of the relevant factual information was known to the plaintiff or the Moscow Commercial [Arbitrazh] Court. Although the plaintiff did allege that Bank Menatep had an improper relationship with the bidders, this allegation was based merely on the peripheral detail that Bank Menatep provided a guaranty for the two bidders' auction deposit.¹³⁰⁹ Without additional facts and evidence, this was insufficient to prove fraud or collusion. Indeed, the text of the judgments reflect that neither the plaintiff nor the Court was actually aware of RTT's existence, the role played by RTT's employees in manipulating the YUKOS privatization, or the fact that all of the admitted bidders were shell companies owned and controlled by the Russian Oligarchs.¹³¹⁰

¹³⁰⁵ Court Decision of the Moscow Arbitrazh Court of 28 September 2005 (Exhibit HVY-189).

¹³⁰⁶ Court Decision of the Moscow Arbitrazh Court of 28 September 2005 (Exhibit HVY-189).

¹³⁰⁷ Judgment of the Moscow Arbitrazh Court of 28 March 1996 (Exhibit HVY-186); Ruling in appeal of the Moscow Arbitrazh Court of 30 May 1996 (Exhibit HVY-187); Ruling in cassation of the Moscow Federal Arbitrazh Court of 24 July 1996 (Exhibit HVY-188).

¹³⁰⁸ Judgment of the Moscow Arbitrazh Court of 28 March 1996 (Exhibit HVY-186); Ruling in appeal of the Moscow Arbitrazh Court of 30 May 1996 (Exhibit HVY-187); Ruling in cassation of the Moscow Federal Arbitrazh Court of 24 July 1996 (Exhibit HVY-188).

¹³⁰⁹ Judgment of the Moscow Arbitrazh Court of 28 March 1996 (Exhibit HVY-186); Ruling in appeal of the Moscow Arbitrazh Court of 30 May 1996 (Exhibit HVY-187); Ruling in cassation of the Moscow Federal Arbitrazh Court of 24 July 1996 (Exhibit HVY-188).

¹³¹⁰ Judgment of the Moscow Arbitrazh Court of 28 March 1996 (Exhibit HVY-186); Ruling in appeal of the Moscow Arbitrazh Court of 30 May 1996 (Exhibit HVY-187); Ruling in cassation of the Moscow Federal Arbitrazh Court of 24 July 1996 (Exhibit HVY-188).

747. Accordingly, the four judgments relied upon by HVY do not demonstrate that the YUKOS privatization was legal, or absolve the Russian Oligarchs of criminal responsibility for fraud, collusion and bribery.

(c)(iii) *The Russian Federation Raised In The Writ Its Objections With Respect To The Pervasive Illegality Of HVY And The Russian Oligarchs, And Never Waived Those Objections*

(c)(iii)(i) *Dutch Law*

748. Lacking a convincing substantive defence against the Russian Federation’s argument regarding the unclean hands (part of the illegality of HVY's investment)¹³¹¹ of HVY and the Russian Oligarchs, HVY assert that the Russian Federation did not raise its unclean hands argument in the Writ insofar it has not raised the acquisition by the Russian Oligarchs in the Writ and that the Russian Federation even abandoned this argument unconditionally in § 27 of the Writ.¹³¹² These formal defences should fail for several reasons.

749. The Russian Federation argued in the Writ, among others, that HVY are not protected “Investors” for purposes of Article 1(7) ECT and did not make a protected “Investment” within the meaning of Article 1(6) ECT¹³¹³; and therefore HVY and their Yukos shares are not protected under the ECT, and that, accordingly, the Yukos Awards should be set aside pursuant to Article 1065(1)(a) DCCP on account of the Tribunal’s lack of jurisdiction.¹³¹⁴

750. To substantiate this, the Russian Federation advanced, among other things, that:

- (i) the Russian Oligarchs through (predecessors of) HVY through deceit, corruption and fraud, acquired and maintained the beneficial ownership and control of, and power over, Yukos;¹³¹⁵
- (ii) HVY were incorporated and used by the Russian Oligarchs to evade taxation, to disguise the Russian Oligarchs and to pursue claims under the ECT;¹³¹⁶ and

¹³¹¹ See SoR, §§ 258-272.

¹³¹² See also SoA, §§ 808-814 and 822-823.

¹³¹³ Writ, § 80. See also Writ, §§ 20(b), 101(b) and 248.

¹³¹⁴ Writ, § 256.

¹³¹⁵ Writ, §§ 1, 18, 26, 42, 50, 66, 248, 257-261.

(iii) HVY are merely sham companies that do not engage in any business activities.¹³¹⁷

751. The Russian Federation elaborated its arguments in the context of this ground for setting aside in more detail in its Reply,¹³¹⁸ Pleading Notes¹³¹⁹ and above, in its Defence on Appeal.¹³²⁰
752. Based on established case law, a ground for setting aside raised in the Writ against a decision of the tribunal can be elaborated further at a later stage.¹³²¹
753. Since the Russian Federation in the Writ directed a ground for setting aside against the *entire* decision of the Tribunal that HVY and their shares in Yukos met the requirements of Article 1(6) and (7) ECT, it was allowed to elaborate this ground further in the later submissions.
754. The Russian Federation's arguments in these Setting Aside Proceedings moreover link up with the arguments it advanced in the Arbitrations; there, too, it explained that the criminal and unlawful background and acts of HVY and the Russian Oligarchs should result in the Tribunal's lack of jurisdiction.¹³²² The Russian Federation's arguments therefore cannot have come as a surprise to HVY. On the contrary, HVY even acknowledge that the unclean

¹³¹⁶ See also Writ, §§ 42-43, 66, 248 and 255(d).

¹³¹⁷ Writ, §§ 5, 6, 9, 20(b), 66, 101(b), 248, 255(c), 257-261.

¹³¹⁸ See particularly SoR, § 30 and Chapter III.D, in which the Russian Federation sets out the following cases of illegal acts by HVY and the Russian Oligarchs: (i) the acquisition and consolidation of control over Yukos, (ii) conduct related to the DTA between Cyprus and Russia, (iii) conduct related to Yukos' tax optimisation scheme and (iv) actions taken in hindrance of the enforcement of Russia's tax claims.

¹³¹⁹ Pleading Notes RF, §§ 40-50.

¹³²⁰ DoA, chapter III.B.

¹³²¹ Supreme Court 27 March 2009, NJ 2010/169 (*Hendrix Poultry / Burshan*), ground 4.3.4; Supreme Court 27 March 2009, NJ 2010/170 (*Smit / Ruwa*), ground 3.4.2; Supreme Court 22 March 2013, NJ 2013/189 (*Bursa / Güris*), ground 3.4.2.

¹³²² See Respondent's Statement of Defence § 9 (*"The circumstances under which the Russian oligarchs themselves obtained their shareholding in Yukos are well documented, demonstrating not only the illegal nature of the transactions in which they engage, but also that any investment in Yukos came from Russia itself"*); Respondent's Counter-Memorial on the Merits, particularly Chapter IV.C (*"The Tribunal Lacks Jurisdiction Or The Claims Are Inadmissible Because Of Claimants' Illegal Conduct And Illegal Conduct Attributable To Them"*) and Respondent's Rejoinder on the Merits, particularly Chapter XVI.D (*"Claimants Have Failed To Rebut Respondent's Showing That ECT Protection Does Not Extend To Illegal Investments"*). See also HVY's Reply on the Merits §§ IV.C.1 (*"The Respondent's case on unclean hands and contributory negligence lacks merit"*) and V.C (*"The Respondent's So-Called 'Unclean Hands' Theory Is Without Any Merit"*); *Hulley*, Merits Hearing Tr. (11 Oct. 2012) 17:25-18:17 (denying unclean hands allegations, including as to the acquisition of Yukos in 1995, as *"unrelated to the Claimants"*); Final Awards, marginal nos. 1283 and 1307.

hands argument was raised by the Russian Federation in the Arbitrations, in the context of, among other things, the Tribunal's jurisdiction.¹³²³ In addition, the unclean hands issues have been litigated at length by both HVY and the Russian Federation in multiple other jurisdictions as part of Award enforcement proceedings around the world, including in Germany, France, and the United States.¹³²⁴ Indeed, in the French proceedings, HVY filed extensive substantive responses on these issues – including a witness statement from one of the Russian Oligarchs, Mr. Vladimir Dubov, and an expert report on corruption by Professor Didier Rebut – *the very same week* that they filed their Statement of Appeal with this Court.¹³²⁵ That HVY have purposefully decided not to address these issues in their Statement of Appeal – pretending that they need to wait for a potential reply opportunity to do so – does not change the fact that the parties have already joined issue on these matters in the Arbitration, before the District Court, and elsewhere.

755. HVY therefore wrongly assert that the unclean hands argument, which is part of the Russian Federation's defence against the decision of the Tribunal that HVY and their shares in Yukos met the requirements of Articles 1(6) and 1(7) ECT, was raised too late. That the Russian Federation did not explicitly mention in the Writ every paragraph of the Yukos Awards affected by its unclean hands argument¹³²⁶ does not mean that the further elaboration thereof in the Statement of Reply was too late. Neither the law nor due process requires such an exact specification of marginal numbers of an arbitral award.
756. In addition, HVY wrongly argue that the Russian Federation explicitly waived its unclean hands argument in § 27 of the Writ, in which the Russian Federation states that “the legal infirmities surrounding Yukos' founding are not one of the grounds on which the Russian Federation is seeking to have the Yukos Awards set aside”.

¹³²³ SoA, §§ 805-806.

¹³²⁴ See *Hulley Enterprises Ltd. v. Russian Federation*, Kammergericht [KG] [Berlin High Regional Court], Reference No. 20 Sch 7/15, Russian Federation brief dated 20 Apr. 2016 & Hulley brief dated 29 June 2016; *Russian Federation v. Hulley Enterprises*, Paris Court of Appeal, Case No. 15/11667, Russian Federation brief dated 16 June 2016 & Hulley brief dated 8 Dec. 2016; *Hulley Enterprises Ltd. v. Russian Federation*, U.S. District Court for the District of Columbia, Case No. 1:14-cv-01996-BAH, Russian Federation Supplemental Motion to Dismiss dated 5 June 2016.

¹³²⁵ Witness Statement of Vladimir Dubov dated 13 Mar. 2016, *Russian Federation v. Hulley Enterprises*, Paris Court of Appeal; Expert Report of Professor Didier Rebut dated 16 Mar. 2017, *Russian Federation v. Hulley Enterprises*, Paris Court of Appeal. For this Court's reference, these statements are submitted as exhibits to, and addressed in, the expert report of Professor Pieth. See Expert Report of Professor Mark Pieth dated 10 Oct. 2017, Annexes E & F.

¹³²⁶ Cf. SoA, § 808.

757. HVY pull this statement of the Russian Federation completely out of its context by asserting that the Russian Federation “explicitly and unconditionally admitted” that the illegal acts involving the privatisation of Yukos and subsequent illegal acts could not be assessed in these setting-aside proceedings or “expressly and unconditionally waived” any rights to raise the unclean hands argument as a setting-aside ground.¹³²⁷ The Russian Federation never intended to do that and indeed § 27 of the Writ states nothing of the sort. Moreover, no agent of the State has any such power to waive what is illegal and invalid under the enabling act: under the Presidential decree governing the LFS program, any non-competitive (i.e., collusive and corrupt) acquisition of the Yukos shares would be legally invalid and void.¹³²⁸ HVY therefore cannot truly have thought that the Russian Federation waived the issue, given the Russian Federation’s arguments in the Arbitrations and (other paragraphs of) the Writ.¹³²⁹
758. What the Russian Federation merely stated in the Writ, is that the founding of Yukos would not be put up for discussion.¹³³⁰ All illegal practices of HVY and the Russian Oligarchs, such as those regarding the acquisition of the Yukos shares by both the Russian Oligarchs and later HVY, have already been explained in detail in the Writ, such as in Chapter II of the Writ, relevant backgrounds, and the Russian Federation uses this as a basis for its statement that HVY are not entitled to protection under the ECT. After all, they are fake foreign investors and with a fake foreign investment.
759. Should, notwithstanding the foregoing, your Court be of the opinion that the sentence at issue in § 27 of the Writ has a broader meaning, it is still the case that the contents of § 27 of the Writ do not detract from the Russian Federation’s ground for setting aside against the Tribunal’s decisions that HVY qualify as “Investors” for purposes of Article 1(7) ECT, that their Yukos shares qualify as an “Investment” within the meaning of Article 1(6) ECT and that the Tribunal therefore had jurisdiction to hear HVY’s claims. It is untenable to argue that the Russian Federation has waived this setting aside ground and the relevant accompanying arguments.

¹³²⁷ SoA, §§ 809-814.

¹³²⁸ See Presidential Decree No. 889 dated 31 Aug. 1995, Art. 6; see also Declaration of Dmitry Gololobov § 13.

¹³²⁹ See in particular Writ, §§ 1, 5, 6, 9, 18, 20(b), 26, 42-43, 50 66, 101(b), 248, 255(c), 255(d), 257-261.

¹³³⁰ SoR, fn. 1.

760. HVY make no effort to substantiate the basis for their defence. For that reason alone, HVY's defence should fail. To the extent that HVY rely on a judicial admission¹³³¹ or waiver of a right¹³³² by the Russian Federation, that reliance fails. Indeed, the waiver of a right requires that the right is deliberately abandoned¹³³³, while a judicial admission requires an explicit and unambiguous acknowledgement of the truth of one or more of the other party's assertions.¹³³⁴ In both cases, the standard for applicability is strict, partly because of the consequences attached to such a waiver or acknowledgement. Partly given the arguments advanced by the Russian Federation in the Writ with regard to HVY and the Russian Oligarchs, that standard has not been met.
761. HVY's arguments should also fail for another reason. The unclean hands argument as well as the other arguments relating to the criminal and unlawful acts of HVY concern matters of public policy on which the plea cannot be limited by formal rules. In the words of Professor Keirse and Paijmans:
- “The justification for applying the unclean hands adage and denying a claimant's right of action appears to lie not in the protection of a defendant's rights, retribution or punishment, but rather in the preservation of judicial integrity, justice and public policy.”¹³³⁵
762. In other words, an argument regarding unclean hands – or criminal and unlawful purposes and acts in a larger connection – brought only after the writ of summons or even for the first time on appeal must also be heard. Neither Article 1064(5) DCCP nor any other applicable rule intends to dispose this.¹³³⁶ Moreover, in the factual and legal circumstances of this case, an irrevocable waiver of the right to invoke matters of public policy – such as

¹³³¹ Cf. SoA, § 810: "*Thus, in paragraph 27 of the Writ of Summons, the Russian Federation unambiguously **admits** that the events it describes in Part II.A.(a) of the Writ of Summons (...) are not eligible for discussion in the setting-aside proceedings and for this reason do not belong to its setting-aside grounds.*" (emphasis added).

¹³³² Cf. also SoA, § 811, "*Despite the Russian Federation's express and unconditional **waiver** of this argument in the Writ of Summons (...)*" (emphasis added). See also SoA, § 814.

¹³³³ Tjittes, *Afstand van recht*, Monografieën Nieuw BW, Kluwer: Deventer 1992, p. 8.

¹³³⁴ Cf. Beenders, *Tekst en Commentaar Rechtsvordering*, Article 154, annotation 2.b.

¹³³⁵ A.L.M. Keirse and B.M. Paijmans, *In pari delicto; als de pot de ketel verwijt*, MvV 2017, number 7-8, p. 209.

¹³³⁶ After all, the starting point that in the writ of summons all grounds for setting aside must be put forward on pain of forfeiture of rights is varied from in case of grounds for setting aside that are of public policy. See also Sanders, *Het Nederlandse arbitragerecht: nationaal en internationaal*, Deventer: Kluwer 2001, p. 190-191, Meijer, *T&C Rv*, art. 1064a Rv, note 5(b), Snijders, *GS Burgerlijke Rechtsvordering*, art. 1064 Rv, note 3.

the unclean hands argument – may be assumed even less quickly, and in any event not on the basis of a passage in § 27 of the Writ drawn completely from its context.

763. It follows from the above (i) that even if the unclean hands argument was insufficiently advanced by the Russian Federation in the Writ (which is not the case), this Court of Appeal still cannot brush it aside for being raised too late and (ii) that there can be no question of a waiver of rights, judicial admission, or any other basis on which the Russian Federation has lost its right to argue that the criminal and unlawful acts of HVY and the Russian Oligarchs means that HVY's claims do not meet the requirements of Article 1(6) and (7) ECT and that the Tribunal therefore did not have jurisdiction with respect to those claims. This is even more so if, as in this case, new criminal facts as fraud and corruption, and/or new proof thereof only surface in the course of the setting aside proceedings. Moreover, the court – thus also your appeal court – must, by its own motion, prevent violations of public policy.¹³³⁷
764. It should be noted that the Russian Federation cannot be deemed to have abandoned its unclean hands argument under international practice¹³³⁸ either.

(c)(iii)(ii) *International Law*

765. It is well established under international law that waiver or renunciation of a claim by a sovereign State must be “express or unequivocally implied,”¹³³⁹ and must be demonstrated by “conclusive evidence.”¹³⁴⁰ Additionally, for a waiver to be valid, it must be “expressed by an organ competent to act on behalf of the subject of international law whose rights are being waived.”¹³⁴¹ There thus is a strong presumption against finding that a State has waived a legal claim or right. It also is well established under international law that issues of fraud and corruption cannot be waived. Such behavior is universally condemned as

¹³³⁷ See *infra* chapter VII.H.

¹³³⁸ Which is considered relevant not only by the Russian Federation but also by HVY; see for example SoD, § II.574.

¹³³⁹ *Armed Activities on the Territory of the Congo (Democratic Republic of the Congo v. Uganda)*, Judgment dated 19 Dec. 2005, I.C.J. Reports 2005, 168, at 266 § 293 (**Exhibit RF-376**): “*express or unequivocally implied*”.

¹³⁴⁰ *The "Kronprins Gustaf Adolf" (Sweden/United States of America)*, Award dated 18 July 1932, R.I.A.A. vol. 2, 1239, at 1299 (**Exhibit RF-377**): “*conclusive evidence*”.

¹³⁴¹ Isabel Feichtner, *Waiver* § 11, in MAX PLANCK ENCYCLOPEDIA OF PUBLIC INTERNATIONAL LAW (2006) (**Exhibit RF-378**): “*expressed by an organ competent to act on behalf of the subject of international law whose rights are being waived*”.

against international public policy and therefore must always be examined by the relevant court or tribunal. The Russian Federation thus cannot be found to have waived its unclean hands argument arising out of the Russian Oligarchs', and HVY as immediate successor, corrupt and fraudulent acts, which must cause HVY to lose their protection under the ECT.

766. International tribunals have declined to find a State's intention to waive a legal claim or right without an "unequivocal" statement. In *Certain Phosphate Lands in Nauru*, for example, Australia asserted that Nauru had waived its claims relating to rehabilitation of the phosphate lands, because those claims had not been referenced in a subsequent agreement between the parties concerning the conditions under which the phosphate industry in Nauru was to pass to the local authorities, or in a statement made by the Nauruan Head Chief to the United Nations at the occasion of the termination of the trusteeship over Nauru.¹³⁴² The ICJ found that Nauru's authorities had not waived the claims, as their conduct "did not at any time effect a clear and unequivocal waiver of their claims, whether one takes into account the negotiations which led to the Agreement of 14 November 1967, the Agreement itself, or the discussions at the United Nations."¹³⁴³
767. Likewise, the tribunal in *Waste Management I* confirmed that an expression of waiver must be "clear, explicit and categorical."¹³⁴⁴ Specifically, that tribunal observed that waiver "is a unilateral act" that is a voluntary and "substantial modification of the pre-existing legal situation, namely, the forfeiting or extinguishment of the right."¹³⁴⁵ The tribunal thus held that, "in any context," "any waiver must be clear, explicit and categorical, it being improper to deduce same from expressions the meaning of which is at all dubious."¹³⁴⁶

¹³⁴² *Certain Phosphate Lands in Nauru (Nauru v. Australia)*, Preliminary Objections, Judgment dated 26 June 1992, I.C.J. Reports 1992, 240, at 247 § 12 (**Exhibit RF-379**).

¹³⁴³ *Certain Phosphate Lands in Nauru (Nauru v. Australia)*, Preliminary Objections, Judgment dated 26 June 1992, I.C.J. Reports 1992, 240, at 247 § 13 (**Exhibit RF-379**): "did not at any time effect a clear and unequivocal waiver of their claims, whether one takes into account the negotiations with led to the Agreement of 14 November 1967, the Agreement itself, or the discussions at the United Nations."

¹³⁴⁴ *Waste Management Inc. v. United Mexican States I*, ICSID Case No. ARB(AF)/98/2, Award dated 2 June 2000, § 18 (**Exhibit RF-380**): "clear, explicit and categorical."

¹³⁴⁵ *Waste Management Inc. v. United Mexican States I*, ICSID Case No. ARB(AF)/98/2, Award dated 2 June 2000, § 18 (**Exhibit RF-380**): "is a unilateral act" that is a voluntary and "substantial modification of the pre-existing legal situation, namely, the forfeiting or extinguishment of the right."

¹³⁴⁶ *Waste Management Inc. v. United Mexican States I*, ICSID Case No. ARB(AF)/98/2, Award dated 2 June 2000, § 18 (**Exhibit RF-380**): "in any context," "any waiver must be clear, explicit and categorical, it being improper to deduce same from expressions the meaning of which is at all dubious."

UNOFFICIAL TRANSLATION

This text is an unofficial translation of the Dutch original. In case of any discrepancies, the Dutch original shall prevail.

768. Under international law, States should not be presumed to have waived a claim or right without conclusive evidence confirming the waiver. In *The "Kronprins Gustaf Adolf,"* for example, the tribunal held that "a renunciation to a right or a claim is not to be presumed," and "must be shown by conclusive evidence."¹³⁴⁷ Similarly, in the *Island of Palmas* case, the tribunal held that proof of waiver of territorial sovereignty rights requires more than "mere silence of the territorial sovereign as regards a treaty which has been notified to him and which seems to dispose of a part of his territory."¹³⁴⁸
769. The presumption against waiver by a State also applies to arguments advanced in dispute resolution proceedings. In *Certain Norwegian Loans*, for example, the ICJ rejected France's argument that Norway had abandoned one of its grounds for a jurisdictional objection, because "abandonment cannot be presumed or inferred; it must be declared expressly."¹³⁴⁹ As an example of what a State *can* do to waive a right, the ICJ pointed to Norway's direct declaration in its Counter-Memorial of its "immediate and unconditional abandonment of its second Objection," and the parties' subsequent failure to address the second Objection in the remaining pleadings, as well as at oral argument.¹³⁵⁰
770. This also is in accord with Professor Nolte's Expert Opinion, in which he confirms that under international law a waiver "must either be express or unequivocally implied from the conduct of the State alleged to have waived or renounced its right," and that even "creating an impression" is insufficient to meet this standard.¹³⁵¹

¹³⁴⁷ *The "Kronprins Gustaf Adolf" (Sweden/United States of America)*, Award dated 18 July 1932, R.I.A.A. vol. 2, 1239, at 1299 (**Exhibit RF-377**): "a renunciation to a right or a claim is not to be presumed," and "must be shown by conclusive evidence."

¹³⁴⁸ *Island of Palmas Case (Netherlands v. U.S.A.)*, Award dated 4 Apr. 1928, R.I.A.A. vol. 2, 829, at 843 (**Exhibit RF-381**): "mere silence of the territorial sovereign as regards a treaty which has been notified to him and which seems to dispose of a part of his territory."

¹³⁴⁹ *Case of Certain Norwegian Loans (France v. Norway)*, Judgment dated 6 July 1957, I.C.J. Reports 1957, 9, at 26 (**Exhibit RF-382**): "abandonment cannot be presumed or inferred; it must be declared expressly."

¹³⁵⁰ *Case of Certain Norwegian Loans (France v. Norway)*, Judgment dated 6 July 1957, I.C.J. Reports 1957, 9, at 22 (**Exhibit RF-382**): "immediate and unconditional abandonment of its second Objection".

¹³⁵¹ See Expert Opinion of Prof. Nolte § 89 (**Exhibit RF-D2**) (quoting *Armed Activities on the Territory of the Congo (Democratic Republic of the Congo v. Uganda)*, Judgment dated 19 Dec. 2005, I.C.J. Reports 2005, 168, at 266 § 293: "must either be express or unequivocally implied from the conduct of the State alleged to have waived or renounced its right" and that even "creating an impression" is insufficient to meet this standard).

771. Implicit waiver by a State likewise requires State action that meets a high threshold. In the *Russian Indemnity* arbitration, the tribunal found that Russia had renounced its right to interest on a debt owed by Turkey, because the Russian Embassy had “repeatedly accepted” the Ottoman representation of the remaining balance, and had “mentioned again and again in its own diplomatic correspondence the amount of the balance of the indemnity as identical with the amount of the balance of the principal.”¹³⁵² Unlike the Russian Embassy in *Russian Indemnity*, the Russian Federation in the present case has not repeatedly and expressly adopted HVY’s position regarding unclean hands. To the contrary, the Russian Federation has consistently argued during the course of the Arbitrations and in the District Court of The Hague that HVY’s alleged investment in Yukos was tainted with pervasive illegality committed by and through HVY and the Russian Oligarchs who own and control them.
772. Contrary to HVY’s assertions, also under international law, as under Dutch law, the sentence objected to in § 27 of the Writ cannot be explained as a waiver of any argument regarding the fact that HVY nor their investments are protected under the ECT. Unlike Norway in *Certain Norwegian Loans*, § 27 of the Writ does not refer to the Russian Federation’s intent to waive its ‘unclean hands’ argument, particularly given its other statements in the Writ, further to and with reference to the Arbitrations, regarding the illegality of HVY and the Russian Oligarchs.
773. Moreover, even if the Russian Federation’s statement in the Writ were to be construed as a waiver, which it should not, it is well established under international law (and by the way also according to Dutch law) that issues of fraud and corruption, which are universally condemned as against international public policy, cannot be waived. As Bin Cheng observes in his seminal treatise on the principles of international law, “[a] judgment, which in principle calls for the greatest respect, will not be upheld if it is the result of fraud . . . when it is alleged that an international tribunal has been ‘misled by fraud and collusion on the part of the witnesses and suppression of evidence on the part of some of them,’ ‘no tribunal worthy of its name or of any respect may allow its decision to stand if such

¹³⁵² *Russian Claim for Interest on Indemnities (Russia v. Turkey)*, Award dated 11 Nov. 1912, Scott’s Hague Court Reports, 297, at 322-323 (**Exhibit RF-383**): “repeatedly accepted” and “mentioned again and again in its own diplomatic correspondence the amount of the balance of the indemnity as identical with the amount of the balance of the principal.”

UNOFFICIAL TRANSLATION

This text is an unofficial translation of the Dutch original. In case of any discrepancies, the Dutch original shall prevail.

allegations are well-founded.”¹³⁵³ He further observes that “[e]very tribunal has an inherent power to reopen and to revise a decision induced by fraud,’ as long as it still has jurisdiction over the case,” and that, “[e]ven where the judgment has passed out of the hands of the tribunal, a State, on discovering that an award made in its favour has been induced by fraud practiced upon the tribunal by the claimants, would refuse to enforce it and would restore any money received in execution of the award, as for instance in the *La Abra Silver Mining Co. Case* (C. 1868) and the *Benjamin Weil Case* (C. 1868).”¹³⁵⁴

774. In *La Abra Silver Mining Co.* and *Benjamin Weil*, 22 years after the awards in those cases had been rendered, the United States Court of Claims found that the awards had been obtained by fraud and that the United States should restore the payments received in execution of the fraudulently obtained awards as a matter of “honor and duty.”¹³⁵⁵ The United States Supreme Court affirmed the Court of Claims’ decision in *La Abra Silver Mining Co.*¹³⁵⁶
775. In the *Sabotage Cases* (1939), the Mixed Claims Commission of the United States and Germany concluded that the proof of fraud in that case was sufficient for the Commission to use its inherent power to set aside a decision based upon false and fraudulent evidence and even to reopen the case.¹³⁵⁷

¹³⁵³ BIN CHENG, GENERAL PRINCIPLES OF LAW AS APPLIED BY INTERNATIONAL COURTS AND TRIBUNALS (2006), at 159 (**Exhibit RF-384**): “[a] judgment, which in principle calls for the greatest respect, will not be upheld if it is the result of fraud . . . when it is alleged that an international tribunal has been ‘misled by fraud and collusion on the part of the witnesses and suppression of evidence on the part of some of them,’ ‘no tribunal worthy of its name or of any respect may allow its decision to stand if such allegations are well-founded.’”

¹³⁵⁴ BIN CHENG, GENERAL PRINCIPLES OF LAW AS APPLIED BY INTERNATIONAL COURTS AND TRIBUNALS (2006), at 159-160 (**Exhibit RF-384**): “[e]very tribunal has an inherent power to reopen and to revise a decision induced by fraud, as long as it still has jurisdiction over the case” and that “[e]ven where the judgment has passed out of the hands of the tribunal, a State, on discovering that an award made in its favour has been induced by fraud practiced upon the tribunal by the claimants, would refuse to enforce it and would restore any money received in execution of the award, as for instance in the *La Abra Silver Mining Co. Case* (C. 1868) and the *Benjamin Weil Case* (C. 1868).”

¹³⁵⁵ *United States v. La Abra Silver Mining Co.*, 32 Ct. Cl. 462 (1897) (**Exhibit RF-385**); *United States v. Weil*, 35 Ct. Cl. 42 (1900) (**Exhibit RF-386**).

¹³⁵⁶ *La Abra Silver Mining Co. v. United States*, 175 U.S. 423 (1899) (**Exhibit RF-387**).

¹³⁵⁷ *Lehigh Valley Railroad Company, Agency of Canadian Car and Foundry Company, Limited, and Various Underwriters (United States) v. Germany (Sabotage Cases)*, Opinion dated 15 June 1939, R.I.A.A. vol. VIII, p. 225, at 239, 458-459 (**Exhibit RF-388**).

No tribunal worthy its name or of any respect may allow its decision to stand if such allegations are wellfounded. Every tribunal has inherent power to reopen and to revise a decision induced by fraud. If it may correct its own errors and mistakes, *a fortiori* it may, while it still has jurisdiction of a cause, correct errors into which it has been led by fraud and collusion.¹³⁵⁸

776. More recently, the Iran-United States Claims Tribunal in *Ram International Industries v. Air Force of Iran* observed that a tribunal “would by implication . . . have the authority to revise decisions induced by fraud.”¹³⁵⁹ And, in a decision rendered earlier this year in *Anatolie Stati v. Republic of Kazakhstan*, the English Commercial Court, seized with an application to enforce a Swedish arbitral award based on the ECT, found “a sufficient prima facie case that the Award was obtained by fraud,” and thus granted permission for the fraud issue to be considered at a subsequent trial.¹³⁶⁰ The Court reasoned that:

It will do nothing for the integrity of arbitration as a process or its supervision by the Courts, or the New York Convention, or for the enforcement of arbitration awards in various countries, if the fraud allegations in the present case are not examined at a trial and decided on their merits, including the question of the effect of the fraud where found. The interests of justice require that examination.¹³⁶¹

777. Indeed, in *Kyrgyz Republic v. Belokon*, the Court of Appeal of Paris earlier this year set aside an arbitral award on grounds of illegality (specifically, that the purpose of the investment at issue was to facilitate money-laundering), finding that “the recognition or enforcement of the award, which would have the effect of allowing Mr. Belokon to benefit

¹³⁵⁸ *Lehigh Valley Railroad Company, Agency of Canadian Car and Foundry Company, Limited, and Various Underwriters (United States) v. Germany (Sabotage Cases)*, Opinion dated 15 June 1939, R.I.A.A. vol. VIII, 225, at 239 (**Exhibit RF-388**): “No tribunal worthy its name or of any respect may allow its decision to stand if such allegations are wellfounded. Every tribunal has inherent power to reopen and to revise a decision induced by fraud. If it may correct its own errors and mistakes, *a fortiori* it may, while it still has jurisdiction of a cause, correct errors into which it has been led by fraud and collusion.”.

¹³⁵⁹ *Ram International Industries v. Air Force of Iran*, Iran-US Cl. Trib. Rep. vol. 29, 383, at 390, § 20 (1993) (**Exhibit RF-389**): “would by implication . . . have the authority to revise decisions induced by fraud.”.

¹³⁶⁰ *Anatolie Stati and others v. The Republic of Kazakhstan*, Judgment dated 6 June 2017, [2017] EWHC 1348 (Comm) §§ 92, 95 (**Exhibit RF-390**): “a sufficient prima facie case that the Award was obtained by fraud”.

¹³⁶¹ *Anatolie Stati and others v. The Republic of Kazakhstan*, Judgment dated 6 June 2017, [2017] EWHC 1348 (Comm) § 93 (**Exhibit RF-390**): “It will do nothing for the integrity of arbitration as a process or its supervision by the Courts, or the New York Convention, or for the enforcement of arbitration awards in various countries, if the fraud allegations in the present case are not examined at a trial and decided on their merits, including the question of the effect of the fraud where found. The interests of justice require that examination.”.

from the fruit of criminal activities, would violate in a manifest, effective and specific manner international public policy.”¹³⁶²

778. The practice of investment treaty tribunals further confirms that issues of illegality and fraud should be considered with due regard, even where neither of the parties has raised such issues. In *Metal-Tech v. Uzbekistan*, for example, the tribunal held that, when faced with evidence of corruption or other fraudulent conduct, “it is the duty of a tribunal established on the basis of a treaty to verify its jurisdiction under that treaty, even if the parties have not objected to it.”¹³⁶³ The tribunal further held that, if certain facts, such as an unusual payment, raise suspicions of corruption in the course of an arbitration, it is the tribunal’s “duty to inquire about the reasons for such payment.”¹³⁶⁴ On this basis, the tribunal invited the parties to provide further information and evidence regarding certain unsubstantiated consulting payments, and to call for additional testimony, “in the exercise of its *ex officio* powers.”¹³⁶⁵
779. Similarly, in *World Duty Free v. Kenya*, the tribunal held that bribery is “contrary to international public policy of most, if not all, States or, to use another formula, to transnational public policy,” and that “claims based on contracts of corruption or on contracts obtained by corruption cannot be upheld.”¹³⁶⁶ And, in *Inceysa v. El Salvador*, the tribunal found that: “[n]o legal system based on rational grounds allows the party that committed a chain of clearly illegal acts to benefit from them.”¹³⁶⁷

¹³⁶² *République du Kirghizistan c. M. Valeriy Belokon*, Cour d'Appel de Paris, Pôle 1, Ch. 1, Judgment dated 21 Feb. 2017, at 15 (**Exhibit RF-391**) (« la reconnaissance ou l'exécution de la sentence entreprise, qui aurait pour effet de faire bénéficier M. BELOKON du produit d'activités délictueuses, viole de manière manifeste, effective et concrète l'ordre public international »).

¹³⁶³ *Metal-Tech Ltd. v. Republic of Uzbekistan*, ICSID Case No. ARB/10/3, Award dated 4 Oct. 2013 § 123 (**Exhibit RF-361**): "it is the duty of a tribunal established on the basis of a treaty to verify its jurisdiction under that treaty, even if the parties have not objected to it."

¹³⁶⁴ *Metal-Tech Ltd. v. Republic of Uzbekistan*, ICSID Case No. ARB/10/3, Award dated 4 Oct. 2013 § 241 (**Exhibit RF-361**): "duty to inquire about the reasons for such payment."

¹³⁶⁵ *Metal-Tech Ltd. v. Republic of Uzbekistan*, ICSID Case No. ARB/10/3, Award dated 4 Oct. 2013 § 241 (**Exhibit RF-361**): "in the exercise of its *ex officio* powers."

¹³⁶⁶ *World Duty Free Co. Ltd. v. Republic of Kenya*, ICSID Case No. ARB/00/7, Award dated 4 Oct. 2006 § 157 (**Exhibit RF-365**): "contrary to international public policy of most, if not all, States or, to use another formula, to transnational public policy" and that "claims based on contracts of corruption or on contracts obtained by corruption cannot be upheld."

¹³⁶⁷ *Inceysa Vallisoletana, S.L. v. Republic of El Salvador*, ICSID Case No. ARB/03/26, Award dated 2 Aug. 2006 § 244 (**Exhibit RF-392**): "[n]o legal system based on rational grounds allows the party that committed a chain of clearly illegal acts to benefit from them."

- (d) ***Conclusion: the Tribunal lacked jurisdiction because HVY and their shares in Yukos are not protected under the ECT***

780. HVY and their shares in Yukos are not protected under the ECT. The ECT is concerned with foreign investments, and offers no protection in investment disputes between Russian nationals and the Russian Federation. The ECT's protection also does not extend to HVY and their shares in Yukos, in light of the criminal and illegal backgrounds and acts of HVY and the Russian Oligarchs, including deceit, corruption and tax evasion. HVY therefore could not invoke the arbitration provision of Article 26 ECT, and the Tribunal should not have assumed jurisdiction. The Yukos Award therefore must be set aside pursuant to Article 1065(1)(a) DCCP.

D. Jurisdiction Ground 3 - The Arbitral Tribunal had no jurisdiction pursuant to Article 21 ECT

The Russian Federation refers to:		
<u>Arbitrations:</u>		
Final Awards	Chapter VIII.A.5 Chapter VIII.B.5 Chapter IX.C	marginal nos. 484 - 502 marginal nos. 604 - 760 marginal nos. 1375 - 1447
<u>Setting aside proceedings:</u>		
Writ	Chapter IV.E	§§ 277 - 362
SoD	Part I, Chapter 3.2.4 Part II, Chapter 2.3	§§ 1.96 - 122 §§ II.374 - 458
SoR	Chapter III.E	§§ 274 - 322
SoRej	Chapter 2.4	§§ 199 - 248
RF Pleading Notes	Chapter V	§§ 52 - 64
HVY Pleading Notes	Chapter 2.2	§§ 88 - 94
SoA	Part II, Chapter 10.1-10.4	§§ 741-761

Primary exhibits:	
<u>Arbitrations:</u>	
R-328 (RF-03.2.B-2.328)	EnCana Corporation v. Republic of Ecuador, LCIA, UNCITRAL, Award (Feb. 3, 2006)
Annex (Merits) C 992 (RF-03.2.C-1.993)	Duke Energy Electroquil Partners & Electroquil S.A. v. Republic of Ecuador, ICSID ARB/04/19, Award (Aug. 18, 2008)
Annex (Merits) C 1544 (RF-03.2.C-1.1544)	El Paso Energy International Company v. The Argentine Republic, ICSID ARB/03/15, Award (Oct. 31, 2011)
RME-992 (RF-03.2.C-2.992)	Burlington Resources Inc. v. Republic of Ecuador, ICSID ARB/08/5, Decision on Jurisdiction (June 2, 2010)
RME-3328 (RF-03.2.C-2.3328)	OAo Neftyanaya Kompaniya Yukos v. Russia, ECHR, Appl. No 14902/04, Judgment (Sept. 20, 2011) ("First ECtHR Ruling")
RME-3449 t/m 3457 (RF-03.2.C-2.3449 to 3457)	Russia-Denemark BIT, Russia-Hungary BIT, France-Singapore BIT, France-Bangladesh BIT, Spain-Nigeria BIT, Spain-Trinidad & Tobago BIT, Spain-Jamaica-BIT, Spain-Equatorial-Guinea BIT, Colombia Model BIT, Russia-Sweden BIT

<u>Setting aside proceedings:</u>	
RF-04	Khodorkovskiy and Lebedev v. Russia, ECtHR, Appl. Nos. 11082/06 and 13772/05, Judgment (July 25, 2013)("Second ECtHR Ruling")
RF-76	Russian Federation v. RosInvestCo UK Ltd., Svea Court of Appeal, Case No. T 10060-10 (Sept. 5, 2013)
RF-218	Russian Federation v. GBI 9000 SIVA S.A., ALOS 34 S.L., Orgor de Valores SICAV S.A. and Quasar de Valores SICAV S.A., Svea Court of Appeal, Case No. T9128-14 (Jan. 18, 2016).

Essence of the argument

- The Tribunal wrongly assumed jurisdiction for HVY's claims relating to the taxation measures of the Russian Federation:
- The term "taxation measure" in Article 21(1) ECT includes any legislative, executive and collecting measure relating to taxes. The measures of the Russian Federation contested by HVY qualify as taxation measures within the meaning of Article 21(1) ECT.
- The Russian Federation's taxation measures were based on provisions and established principles of Russian tax law, which are in accord with internationally recognised principles of tax policy and practice, have been assessed as such by the Russian tax courts, and were aimed at generating government revenue.
- The ECtHR judgments in 2011 and 2013 on the complaints of Yukos Oil and Khodorkovsky, respectively, confirm that the measures of the Russian Federation contested by HVY concerned a legitimate – and largely correct – exercise of its power to impose and collect (additional) taxes.
- The foregoing demonstrates that all Russian Federation taxation measures contested by HVY fall outside of the ECT's scope of application on the basis of the carve-out of Article 21(1) ECT, and consequently outside of the scope of the arbitration provision of Article 26 ECT as well.
- These 'carved-out' taxation measures of the Russian Federation are not brought back within the scope of the ECT by the claw-back for expropriation taxes stipulated in Article 21(5) ECT, because the concept of "taxes" in Article 21(5) ECT is restricted in scope compared to the concept of "taxation measure" in Article 21(1) ECT, inasmuch as the former does not include enforcement and collection measures.

- The reliance by the Russian Federation on this ground under Article 1065(1)(a) DCCP is subject to a full and substantive court review, including the facts serving as the bases for the Yukos Awards and the parties' mutual statements in this regard.

(a) ***Introduction***

781. In addition to and notwithstanding the Jurisdiction Grounds 1 and 2, the Russian Federation submits that the Tribunal also erred in assuming jurisdiction over HVY's claims relating to the legitimacy of the "taxation measures" of the Russian Federation. Such taxation measures fall entirely outside the ECT's scope of application pursuant to Article 21 ECT, and were therefore beyond the Tribunal's jurisdiction under Article 26 ECT.¹³⁶⁸

782. Article 21(1) ECT (known as the taxation "carve-out") provides that taxation measures do not fall within the scope of application of the ECT at all, except insofar as Article 21 ECT itself provides otherwise:

"Except as otherwise provided in this Article, nothing in this Treaty shall create rights or impose obligations with respect to Taxation Measures of the Contracting Parties. In the event of any inconsistency between this Article and any other provision of the Treaty, this Article shall prevail to the extent of the inconsistency."¹³⁶⁹ [emphasis added]

783. Having deferred its determination of the Russian Federation's jurisdictional objection relating to Article 21(1) ECT to the merits phase of the Arbitrations,¹³⁷⁰ the Tribunal, in the Final Awards, rejected the Russian Federation's objection under Article 21(1) ECT for two separate self-supporting reasons:¹³⁷¹

- (a) according to the Tribunal, any taxation measure that falls outside the scope of application of the ECT pursuant to the carve-out of Article 21(1) ECT

¹³⁶⁸ The parties' positions on this ground for setting aside are summarized in SoR, §§ 274-278.

¹³⁶⁹ [English original text]: "Except as otherwise provided in this Article, nothing in this Treaty shall create rights or impose obligations with respect to Taxation Measures of the Contracting Parties. In the event of any inconsistency between this Article and any other provision of the Treaty, this Article shall prevail to the extent of the inconsistency." [emphasis added]

¹³⁷⁰ HEL Interim Award, §§ 585, 601(b), VPL Interim Award, §§ 596, 612(b), YUL Interim Award, §§ 585, 601(b).

¹³⁷¹ Final Awards, marginal no. 1406: "[T]he Tribunal concludes that it has jurisdiction to rule on Claimants' claims under Article 13 of the ECT for two independent reasons, each of which in and of itself suffices to justify the jurisdiction of the Tribunal".

will be brought back within the ECT’s scope of application due to the claw-back for expropriating taxes included in Article 21(5) ECT. In the Tribunal’s view, the terms “taxation measures” in Article 21(1) ECT and “taxes” in Article 21(5) ECT therefore concur;¹³⁷² and

- (b) according to the Tribunal, the carve-out included in Article 21(1) ECT only applies to measures motivated by the aim of generating revenue for the State, and the taxation measures of the Russian Federation were not a bona fide exercise of its power to levy taxes.¹³⁷³

784. Both of the Tribunal’s findings, which HVY endorse in their Statement of Appeal,¹³⁷⁴ are incorrect and cannot be upheld. Accordingly, the Yukos Awards deserve to be set aside for this reason since the Tribunal assumed jurisdiction, and in turn the existence of a valid arbitration agreement, when, in fact, none existed.

785. In the sections below, it shall be shown that (i) Article 21 ECT affects the dispute settlement clause in Article 26 ECT, and should therefore lead to the Tribunal’s lack of jurisdiction for the assessment of complaints about taxation measures (**section (b)**); (ii) the exception provided in Article 21(1) ECT (“*[e]xcept as otherwise provided in this Article (...)*”) has not been met in the present case, since the Tribunal applied an incorrect standard in equating “taxation measures” in Article 21(1) ECT to “taxes” on Article 21(5) ECT (**sections (c)-(f)**); and (iii) even under the Tribunal’s incorrect standard, the Russian Federation’s taxation measures must still have been carved out under Article 21(1) ECT, as is shown by the findings of the ECtHR and the fact that the Russian Federation’s taxation measures are consistent with international practices (**sections (g)-(i)**).

786. The Russian Federation fully maintains its substantiation of this ground for setting aside given in the first instance (no valid arbitration agreement, Article 1065(1)(a) DCCP), which must be reviewed substantively without any restraint by this Court of Appeal – also in respect of the relevant facts disputed in this matter.¹³⁷⁵ For the Court of Appeal’s convenience, the Russian Federation will present the essence of its earlier argument once

¹³⁷² Final Awards, marginal no. 1413.

¹³⁷³ Final Awards, marginal nos. 1430-1445.

¹³⁷⁴ SoA, §§ 10.2-10.3.

¹³⁷⁵ See Writ, Section IV.E, and SoR, Section III.E.

again in this chapter, without prejudice to the devolutive effect of the appeal. The Russian Federation will supplement this with the refutation of the defences put forward by HVY before, in and with their Statement of Appeal.¹³⁷⁶

(b) ***The carve-out of Article 21(1) ECT excludes arbitration pursuant to Article 26 ECT on taxation measures***

787. Contrary to HVY's assertion,¹³⁷⁷ the unambiguous meaning of the words “nothing in this Treaty”, in Article 21(1) ECT indicates that the carve-out therein applies to any and all provisions of the ECT – including the dispute settlement clause in Article 26 ECT – unless Article 21 ECT itself provides otherwise. In other words, the carve-out of Article 21(1) ECT is an exception to the alleged consent by the Russian Federation to the settlement of investments disputes under Article 26 ECT. It is not relevant that Article 26 ECT does not refer to Article 21(1) ECT, since the very language of Article 21(1) ECT shows that it prevails over all provisions of the ECT, including Article 26.
788. Interpreting Article 21(1) ECT in accordance with Article 31 VCLT, its broad and all-encompassing ordinary meaning, in its context, and in light of the object and purpose of the ECT, overcomes all other extraneous considerations that HVY attempt to bring into the interpretative process. Thus, the fact that Articles 21(2)-(5) ECT refer to only substantive rights and obligations while creating exceptions for the applicability of the ECT to taxation measures¹³⁷⁸ does not impede the clear ordinary meaning of Article 21(1) ECT, i.e., nothing in the ECT applies to taxation measures except insofar as provided by the remaining provisions of Article 21 ECT itself. To the contrary, the fact that Articles 21(2)-(5) ECT reserve these exceptions only to limited substantive prescriptions in the ECT serves to bolster the ordinary meaning of Article 21(1) ECT that nothing in the ECT other than these limited substantive provisions, including Article 26 ECT, applies to taxation measures. In other words, the text of Article 21(1) ECT does not create a demarcation between substantive rights and obligations and the consent to arbitrate, and such a distinction cannot be read into the treaty provision absent an express stipulation to this effect.

¹³⁷⁶ If there is a new defence, this will be stated.

¹³⁷⁷ SoA, §§ 758-761.

¹³⁷⁸ SoA, § 760.

789. Moreover, HVY's submission, that because Article 21(5) ECT requires a tribunal to refer the dispute to the competent tax authorities the existence of jurisdiction under Article 26 ECT must be assumed,¹³⁷⁹ is an unacceptable circuitous reading of Article 21 ECT, which misrepresents the object and purpose behind such taxation carve-outs. Article 21 ECT, like many other comparable tax carve-outs in investment treaties, is an all pervasive exception to the applicability of the ECT, including the applicability of the dispute resolution clause. Before or failing such a reference to the tax authorities under Article 21(5)(b)(i) ECT, Article 26 ECT cannot become applicable at all, meaning that there is no question of the tribunal's jurisdiction coming into existence. Article 26 ECT and other provisions of the ECT can only potentially become applicable when and subject to such a reference being made to the tax authorities.
790. Such carve-outs for taxation measures are customary in investment treaties.¹³⁸⁰ They are intended to safeguard the sovereignty of States in taxation and prevent conflicts with existing double taxation treaties.¹³⁸¹
791. Tribunals in investment arbitrations have consistently qualified such carve-outs as relating to their jurisdiction, and have consistently declared that they have no jurisdiction with respect to claims based on taxation measures under the carve-out.¹³⁸² In the words of the tribunal in *EnCana v Ecuador*, which was chaired by one of the experts HVY frequently relies on, albeit in the context of Article 45 ECT, i.e., Prof. James Crawford, when a matter is covered by the phrase "taxation measures" in the carve-out clause under interpretation (which was contained in the Canada-Ecuador BIT in that case),¹³⁸³ the "[t]ribunal is not a

¹³⁷⁹ SoA, § 761.

¹³⁸⁰ A well-known example is NAFTA. Paragraphs 1 and 2 of Article 2103 NAFTA read as follows: "1. Except as set out in this Article, nothing in this Agreement shall apply to taxation measures. 2. Nothing in this Agreement shall affect the rights and obligations of any Party under any tax convention. In the event of any inconsistency between this Agreement and any such convention, that convention shall prevail to the extent of the inconsistency."

¹³⁸¹ Writ, §§ 277 and 287, with various references to investment arbitration awards. See §§ 846-852 below.

¹³⁸² Writ, § 284; see *Duke Energy Electroquil Partners & Electroquil S.A. v. Republic of Ecuador*, ICSID ARB/04/19, Award dated 18 August 2008, § 188 (Annex (Merits) C 993); *El Paso Energy International Company v. The Argentine Republic*, ICSID ARB/03/15, Award dated 31 October 2011, § 449 (Annex (Merits) C 1544); *Burlington Resources Inc. v. Republic of Ecuador*, ICSID ARB/08/5, Decision on Jurisdiction dated 2 June 2010, § 249 (RME-992). The carve-outs in the relevant investment treaties are largely similar to those in the ECT, see SoR, § 283.

¹³⁸³ See for the carve-out clause, *EnCana Corporation v. Republic of Ecuador*, LCIA, UNCITRAL, Award dated 3 February 2006, § 108 (R-328).

court of appeal in, and (...) has no jurisdiction over taxation matters [emphasis added]".¹³⁸⁴ In the context of Article 21(1) ECT, the tribunal in *Plama v Bulgaria* has appropriately highlighted the breadth of the carve-out contained therein while stating that "Article 21 of the ECT specifically excludes from the scope of the ECT's protections taxation measures of a Contracting State".¹³⁸⁵ This exclusion applies equally to substantive protections as it does to procedural ones, and the only exceptions to its applicability are contained in Article 21 ECT itself.

792. It follows from the foregoing that the carve-out in Article 21(1) ECT attaches itself to the jurisdiction of the tribunal. Thus, a tribunal appointed on the basis of Article 26 ECT does not have jurisdiction with respect to claims based on complaints in respect of taxation measures.

(c) ***The term "taxation measures" in Article 21(1) ECT includes any legislative, executive and collecting measure***

793. Having established the scope of Article 21(1) ECT vis-à-vis the ECT ("nothing in this Treaty (...)", it is essential to clarify what constitutes the "taxation measures" referred to in Article 21(1) ECT, in the face of the fallacy of the Tribunal's findings in this respect, which are endorsed by HVY in their submissions.¹³⁸⁶

794. Article 21(7)(a) ECT includes an enumeration (not a definition)¹³⁸⁷ of what qualifies as a taxation measure. The text of paragraph 7(a) reads:

"For the purposes of this Article:

a) The term "Taxation Measure" includes:

- i) any provision relating to taxes of the domestic law of the Contracting Party or of a political subdivision thereof or a local authority therein; and
- ii) any provision relating to taxes of any convention for the avoidance of double taxation or of any other international agreement or arrangement by which the Contracting Party is bound."¹³⁸⁸ [emphasis added]

¹³⁸⁴ *EnCana Corporation v. Republic of Ecuador*, LCIA, UNCITRAL, Award dated 3 February 2006, § 145 (R-328).

¹³⁸⁵ *Plama v Bulgaria*, (cross reference to above citation), § 266: "Article 21 of the ECT specifically excludes from the scope of the ECT's protections tax measures of a Contracting State".

¹³⁸⁶ SoA, §§ 750-757.

¹³⁸⁷ Contrary to what the Tribunal finds, see Final Awards, marginal nos. 1411.

795. As is demonstrated by the word “includes” in its ordinary meaning, Article 21(7)(a) ECT contains a non-exhaustive list of what qualifies as a taxation measure within the meaning of Article 21 ECT.¹³⁸⁹ As a matter of context, it is essential to note that the ECT consistently uses the term “includes”¹³⁹⁰ for non-exhaustive lists and “means”¹³⁹¹ for definitions. Furthermore, the *travaux préparatoires* of Article 21 ECT confirm that the Contracting Parties consciously refused to include a definition of taxation measures in the ECT.¹³⁹² All these factors point towards the fact that “taxation measures” have been exemplified in Article 21(7)(a) ECT in an inclusive and not an exhaustive manner.
796. In addition to the above factors, the use of the term “measure” also independently demonstrates that the concept of taxation measures is not limited to the ‘provisions’ referred to in paragraph 7(a) under (i) and (ii). In other words, while the examples contained in Article 21(7)(a) ECT appear to refer to legislative provisions, an objective interpretation of the term “measure” under Article 31(1) VCLT according to its ordinary meaning, read in the context (provided by the use of inclusive and non-exhaustive means to describe “taxation measures”) and in the light of the object and purpose of Article 21 ECT, indicates that such “taxation measures” may ordinarily include legislative, executive and collection measures alike.
797. International courts and tribunals have also confirmed the “breadth of”¹³⁹³ the term “measure” in its ordinary meaning, stating that it covers any legislative, executive¹³⁹⁴ or collecting¹³⁹⁵ measure. In the words of the tribunal in *Loewen Group v United States of*

¹³⁸⁸ [English original text]: “For the purposes of this Article: a) The term “Taxation Measure” includes: (i) any provision relating to taxes of the domestic law of the Contracting Party or of a political subdivision thereof or a local authority therein; and (ii) any provision relating to taxes of any convention for the avoidance of double taxation or of any other international agreement or arrangement by which the Contracting Party is bound.” [emphasis added]

¹³⁸⁹ Writ, § 286, with various references to literature.

¹³⁹⁰ See e.g., apart from Article 21(7)(a) ECT, Article 1(6), 1(10) and 1(12), and Article 19(3)(b) ECT.

¹³⁹¹ See e.g. Article 1(1)-(11) and (13)-(14), Article 7(10), Article 10(3), Article 19(3), Article 21(7)(c), Article 25(2) and Article 36(5) ECT.

¹³⁹² Writ, § 286, SoR, §§ 284-289, with various references to the *travaux préparatoires* and literature that confirm, within the meaning of Article 32 VCLT, the ordinary meaning of the phrase “includes”.

¹³⁹³ *EnCana v Ecuador*, § 142(3).

¹³⁹⁴ In first instance proceedings, the Russian Federation used the substantively equal concepts of “executive” and “enforcement” (and similar wording) interchangeably in this context.

¹³⁹⁵ Writ, § 287, see *Fisheries Jurisdiction (Spain v. Canada)*, Judgment on Jurisdiction, 1998 I.C.J. Rep. 432 dated 4 December 1998, p. 460 § 66 (RME-1028); see also *Burlington v. Ecuador* cit., § 168 (RME-992).

*America, “the word ‘measures’ (...) applies to the acts of judicial as well as legislative and administrative organs.”*¹³⁹⁶

798. The term “taxation” in its ordinary meaning also encompasses tax legislation, enforcement and collection, since ordinarily there is “no reason to limit the term ‘taxation’ (...)”.¹³⁹⁷ The term “taxation measure” therefore includes any legislative, executive or collecting measure relating to taxes.
799. This ordinary meaning of the term “taxation measure” is in line with the objective of carve-outs in investment treaties, i.e., to preserve the sovereign power of States to levy taxes.¹³⁹⁸ By means of these carve-outs, States attempt to realize that disputes relating to taxes fall entirely within the scope of application of the tax treaties, including their dispute resolution procedures.¹³⁹⁹
800. In other words, it emerges from the element “measure” and the inclusive enumeration of such measures in Article 21(7)(a) ECT that a taxation measure does not merely cover the “provisions” listed exclusively in this stipulation.

(d) ***The term “taxes” does not include executive measures and collecting measures***

801. Articles 21(2)-(6) ECT contain certain exceptions to the carve-out of Article 21(1) ECT (claw-backs), through which the situations mentioned in these exceptions are brought back within the scope of the ECT after first being excluded by the operation of Article 21(1) ECT. For example, Article 21(5)(a) ECT, which forms the object of contention between the parties, provides that Article 13 ECT on expropriation shall apply to “taxes” (not: “taxation measures”)

“ARTICLE 13 shall apply to taxes.”¹⁴⁰⁰ [emphasis added]

¹³⁹⁶ *The Loewen Group, Inc. and Raymond L. Loewen v. United States of America*, ICSID ARB(AF)/98/3, Decision on hearing of Respondent’s objection to competence and jurisdiction dated 5 January 2001), § 47 (RME-1021).

¹³⁹⁷ *EnCana v Ecuador*, § 142(2).

¹³⁹⁸ Writ, § 287, with various references to case law and literature.

¹³⁹⁹ *Cf. the Opinion on the Scope of the Term ‘Taxation Measures’ in the Energy Charter Treaty* of Professor D.M. Berman dated 22 January 2007, submitted by the Russian Federation in the Arbitrations, § 10.

¹⁴⁰⁰ [English original text]: “ARTICLE 13 shall apply to taxes.” [emphasis added]

802. Article 21(5) ECT contains a claw-back for expropriating “taxes”, i.e., that certain “taxes” exempted on the basis of Article 21(1) ECT, as part of the term “taxation measures” referred to therein, are brought back within the scope of the ECT by means of paragraph 5. Just like the term “taxation measures”, the term “taxes” has not been defined in the ECT either. However, from the very fact that Article 21(1) ECT refers to “taxation measures”, where-as Article 21(5)(a) ECT refers to “taxes”, it becomes evident that there ought to be a difference in the scope and meaning of these two phrases. Add to that the fact that Articles 21(2)-(4) ECT¹⁴⁰¹ all use the term “taxation measures” as opposed to “taxes” when clawing-back the ECT to apply to taxation measures, where-as Article 21(5)(a) ECT is the only claw-back provision that conspicuously uses the term “taxes” instead of “taxation measures”. As a general starting point for the interpretation of laws and treaties, it must be noted that a difference in wording also indicates a difference in meaning.¹⁴⁰²
803. The ordinary meaning of a “tax” is a contribution imposed by the State for public purposes. Although it arguably may include legislative matters, a “tax” certainly does not include executive measures and collecting measures. While the former, i.e., legislative matters usually constitute prescriptions and/or directives of the State, both of the latter, i.e., executive and collecting measures, are intended to put such prescriptions and/or directives into action and thereby to recover the contribution. Therefore, they are of an entirely different nature. The term “taxes” is generally not defined in international treaties. In this respect, tax treaties usually refer to the domestic law of the taxing State.¹⁴⁰³
804. Russian law defines a tax as a mandatory payment collected to provide financial support to the government. This does not include default interest and fines; these are defined separately as amounts due for late payment and fines for a tax infringement.¹⁴⁰⁴
805. It follows from the foregoing that “taxes” in its ordinary meaning is less extensive than “taxation measures”. Contrary to what the Tribunal held and what HVY argue, these terms cannot be equated.¹⁴⁰⁵

¹⁴⁰¹ Article 21(2) (“*Article 7(3) shall apply to Taxation Measures (...)*”); Article 21(3) (“*Article 10(2) and (7) shall apply to Taxation Measures (...)*”); Article 21(4) (“*Article 29(2) to (8) shall apply to Taxation Measures (...)*”).

¹⁴⁰² See Writ, § 285.

¹⁴⁰³ Writ, § 288, with various references to treaties.

¹⁴⁰⁴ Writ, § 288, with references to Russian tax law.

806. The Tribunal’s opinion that any taxation measure that falls outside the scope of the ECT on the basis of the carve-out of Article 21(1) ECT, is brought back within the scope of the ECT due to the claw-back for expropriating taxes included in Article 21(5) ECT,¹⁴⁰⁶ is contrary to the established rule of treaty interpretation under Article 31 VCLT that the objectively clear ordinary meaning of a treaty cannot be overridden by an interpretation based on the tribunal's own subjective view of a desirable objective. The Tribunal’s approach has been denied by other tribunals in investment arbitrations, and is generally criticized by commentators.¹⁴⁰⁷
807. Similarly, the interpretation that HVY advance in their Statement of Appeal is problematic for not being in line with the fundamental techniques of treaty interpretation provided under Articles 31 and 32 VCLT. HVY’s interpretation of Article 21(1) ECT and its interaction with Article 21(5) ECT begins by taking a recourse to the *travaux préparatoires* of the ECT to confirm that the scope of the two provisions is the same.¹⁴⁰⁸ Thereafter, HVY derive influence from the different linguistic versions of the ECT, i.e., French, Italian, German and Dutch to argue that the equivalent of the phrases “taxes” and “taxation measures” are used interchangeably in these languages.¹⁴⁰⁹
808. However, HVY’s interpretation of Article 21 ECT disregards the VCLT. HVY places premature reliance on extraneous factors, such as the *travaux préparatoires* of the ECT, which represent an unnecessary and insufficient tool of interpretation under Article 32 VCLT when the ordinary meaning of the treaty text is clear and unambiguous as is the case with respect to Articles 21(1) and 21(5) ECT. Further, even when understanding different linguistic texts of the ECT, one must subscribe to the ordinary meaning of each text, as provided in Article 33(4) VCLT, which HVY have not done. In the instant case, the ordinary meaning of the English and Dutch text of Articles 21(1) and (5) of the ECT are

¹⁴⁰⁵ HVY’s new defence, i.e. that the Russian Federation at the case management hearing dated 16 January 2017 did not distinguish the scope of Article 21(1) and (5) ECT, see SoA, § 752, does not hold true. The case management hearing was limited to certain procedural aspects of the appeal and explicitly did not relate to the substance of the case. HVY’s defence should fail for this reason alone. Furthermore, this de-contextualised sentence referred to by HVY cannot affect the specific arguments and evidence on Article 21 ECT on which the Russian Federation in, among other things, the Writ and the SoR based its claims for the setting aside of the Yukos Awards.

¹⁴⁰⁶ Final Awards, marginal no. 1413.

¹⁴⁰⁷ Writ, § 289, with various references to case law and literature.

¹⁴⁰⁸ See SoA, § 753.

¹⁴⁰⁹ See SoA, § 754.

undoubtedly clear in dissociating the concept of “taxation measures” from the concept of “taxes”.

809. Accordingly, HVY’s reliance on the inconsistent use of the relevant terms in the French, German and Italian versions of the ECT cannot benefit them either given the fact of the ordinary meaning of Article 21 ECT in its original English language being clear.¹⁴¹⁰
810. The Tribunal’s reasoning – endorsed by HVY¹⁴¹¹ – that the object and purpose of the ECT would be defeated if the claw-back of Article 21(5) ECT did not restore protection of all taxation measures excluded under Article 21(1) ECT,¹⁴¹² is also directly contradicted by common practice regarding investment treaties. Several investment treaties even contain broader carve-outs without claw-backs for expropriating taxes.¹⁴¹³ In other words, investors under such treaties do not enjoy protection from alleged expropriating taxes under any of these circumstances. Such exclusion from protection is therefore not contrary to the purpose of an investment treaty to encourage and protect investments, which each of these investment treaties aspire for. This means that the limited claw-back for taxes in Article 21(5) ECT is not contrary to the object and purpose of the ECT to create a favourable climate for investments either.¹⁴¹⁴ In any event, the ECT’s multiple objectives cannot be read independently in isolation and must be balanced with other objectives and considerations, one of which is “[r]ecognising the sovereignty of each State (...), and its rights to regulate energy transmission and transportation within its territory”.¹⁴¹⁵
811. Furthermore, HVY’s new assertion that a recent publication of the ECT Secretariat confirms that the scope of Article 21(1) ECT is the same as that of Article 21(5) ECT,¹⁴¹⁶ cannot benefit them. After all, the publication shows that it does not intend to set out the position of the ECT Secretariat or that of Contracting Parties and that this publication does

¹⁴¹⁰ See SoR, §§ 290-299. Contrary to HVY's assertions in § 753 of the SoA, the fact that, in the *travaux préparatoires*, the terms are mistakenly used interchangeably several times, in no way confirms that the scope of Article 21(1) ECT is the same as that of Article 21(5) ECT.

¹⁴¹¹ See SoA, § 755.

¹⁴¹² Final Awards, marginal no. 1413.

¹⁴¹³ SoR, § 293, with various references to articles from investment treaties.

¹⁴¹⁴ SoR, §§ 293-294.

¹⁴¹⁵ European Energy Charter, Title 1 [English original text]: “[r]ecognising the sovereignty of each State (...), and its rights to regulate energy transmission and transportation within its territory”.

¹⁴¹⁶ SoA, § 756.

not affect the rights and obligations of the Contracting Parties under the ECT.¹⁴¹⁷ The publication merely sets out the opinion of one author (a doctoral student at the University of Dundee)¹⁴¹⁸ and not, for example, the opinion of a State, let alone that of all or even a majority of the Contracting Parties. The foregoing demonstrates that this author's opinion is not at all generally shared. This Court of Appeal therefore should disregard this assertion of HVY.

812. In light of the above considerations, the term "taxes" in Article 21(5) ECT is more limited in scope as compared to the term "taxation measures" in Articles 21(1) ECT, since "taxes" do not cover executive and collecting matters, while these matters are covered by the sufficiently open-ended phrase "taxation measures" in Article 21(7)(a) ECT.

(e) ***The contested measures of the Russian Federation are taxation measures but not taxes***

813. As stated above, Article 21(1) ECT provides that "nothing in this Treaty shall create rights or impose obligations with respect to Taxation Measures of the Contracting Parties".¹⁴¹⁹

814. In its ordinary meaning, the term "with respect to" has a broad scope and indicates in its context any direct or indirect link with taxation measures, which is how other decisions have also understood it.¹⁴²⁰

815. The Tribunal held that the Claimants' shares in Yukos were unlawfully expropriated through a series of measures, including, in particular, the tax assessments and related fines imposed on Yukos and the auction of the shares in YNG to pay Yukos' outstanding tax

¹⁴¹⁷ See, for example, U.E. Özgür for ECT Secretariat, "Taxation of Foreign Investments under International Law: Article 21 of the Energy Charter Treaty in Context" (Energy Charter Secretariat 2015), p. 5: "*This study is published without prejudice to the position of Contracting Parties/Signatories or to their rights or obligations under the Energy Charter Treaty or any other international investment agreement.*" and p. 16: "*The views expressed herein do not purport to represent the views of the Energy Charter Secretariat or the Contracting Parties. All errors are the author's alone.*"

¹⁴¹⁸ <https://www.dundee.ac.uk/cepmlp/postgraduatestudy/phdprogramme/phdstudentprofiles/3/index.php>.

¹⁴¹⁹ Emphasis added. [English original text]: "*Except as otherwise provided in this Article, nothing in this Treaty shall create rights or impose obligations with respect to Taxation Measures of the Contracting Parties. In the event of any inconsistency between this Article and any other provision of the Treaty, this Article shall prevail to the extent of the inconsistency.*" [emphasis added]

¹⁴²⁰ See Writ, § 292 (referring to *The Republic of Ecuador v. Occidental Exploration & Production Co.*, QB Division, Comm. Court Case No. 04/656, Judgment dated 2 March 2006, [2006] EWHC 345 (Comm.), § 98 (RME-999)).

debts.¹⁴²¹ Contrary to what HVY argue,¹⁴²² these measures are either executive or collection measures and therefore constitute taxation measures within the ECT.¹⁴²³ However, these measures do not constitute taxes, because such executive or collection measures are not covered by this limited concept that pertains to the State's imposition of a mandatory payment motivated to provide financial support to the government. In fact, Russian law specifically excludes the concept of fines from taxes.¹⁴²⁴

816. Inasmuch as the measures in question constituted "taxation measures", but not "taxes" under Article 21 ECT, the Tribunal's jurisdiction over claims relating to these measures of the Russian Federation contested by HVY therefore cannot be derived from the claw-back of Article 21(5) ECT. Consequently, there is no merit in the first of two separate reasons¹⁴²⁵ on the basis of which the Tribunal considered that it had jurisdiction with respect to the taxation measures of the Russian Federation.

(f) ***The carve-out of Article 21(1) ECT applies to any taxation measures that is sufficiently clearly connected with a taxation law or regulation***

817. Apart from the fact that the Tribunal wrongly equated the terms "taxation measures" and "taxes", it also wrongly held that the carve-out in Article 21(1) ECT does not apply to measures taken only under the guise of taxation¹⁴²⁶ and which are not motivated by the aim of raising public revenue but by a purpose extraneous to taxation".¹⁴²⁷

818. The Tribunal itself hereby applies a restriction to Article 21(1) ECT that is not supported by the text of the ECT and thereby not only oversteps the scheme under Articles 31 and 32 VCLT, but also runs counter to relevant case law and literature.¹⁴²⁸ The text of Article

¹⁴²¹ Final Awards, marginal 1579.

¹⁴²² SoA, § 748. The examples mentioned by HVY were not, or at least, far less relevant to the Tribunal's opinion with regard to violation of Article 13 ECT.

¹⁴²³ See Writ, § 293, SoR, § 299.

¹⁴²⁴ See § 804 above.

¹⁴²⁵ Final Awards, marginal 1406; see also § 783 above.

¹⁴²⁶ Final Awards, marginal 1407.

¹⁴²⁷ Final Awards, marginal nos. 1442-1445.

¹⁴²⁸ See Writ, §§ 294-301, SoR, §§ 284-289 and 312. This is contrasting sharply with the Tribunal's purely textual approach with regard to the definition of "investors" in Article 1(7) ECT. The Tribunal fails to explain the difference in approach, see Sophie Nappert, 'Square Pegs and Round Holes: The Taxation Provision of the Energy Charter Treaty and the Yukos Awards', in: *Cahiers de l'arbitrage*, 1 January 2015, no. 1, p. 9. (**Exhibit RF-209**): "This stands in (unexplained) contrast to the Tribunal's black-letter

21(1) ECT provides that any taxation measure, either lawful or not,¹⁴²⁹ is covered by the carve-out. Any additional motives of tax officials and courts in the application of such tax law-based measures are irrelevant and should not be reviewed either.¹⁴³⁰ Indeed, it could not have been the Contracting Parties' intention to require an arbitral tribunal to analyse any such motives (which at least to a certain extent requires an analysis on the merits) for purposes of determining its jurisdiction under Article 21(1) ECT. HVY therefore wrongly argue that Article 21 ECT relates only to *bona fide* taxation measures.¹⁴³¹ To require a tribunal to first adjudicate upon the lawfulness of the taxation measure in question before making a reference to the tax authorities under Article 21(5) ECT would invariably in many circumstances defeat the purpose of such a referral to the concerned tax authorities.

819. To avoid any misunderstandings: the Russian Federation does not intend to propagate, in any way, the thought that it is trying to justify the imposition of taxation measures in bad faith. In fact, the Russian Federation categorically contests the merit behind such allegations of bad faith below.¹⁴³² However, the essence of the Russian Federation's argument is that the lawfulness or unlawfulness (good faith or bad faith nature) of taxation measures is immaterial for Article 21(1) ECT. Importance attaches here to the fact that any taxation measures wrongly imposed in bad faith are still taxation measures within the meaning of the carve-out of Article 21(1) ECT and are not covered by the claw-back of Article 21(5) ECT. After all, the jurisdiction of the tribunal is fundamentally distinct from and independent of the good faith or bad faith nature of the expropriatory measure in question.
820. One can appreciate the broad ambit of the phrase "taxation measures" and its independence from the question of whether or not the measure was taken in good faith from the following passage by the tribunal in *EnCana v Ecuador*:

*approach to the definition of "Investor" that prevailed when they ruled on the preliminary issue whether the Claimants were protected Investors for the purposes of the ECT, despite being controlled by Russian nationals." See also Sophie Nappert, 'The Yukos Awards - A Comment', *Journal of Damages in International Arbitration*, 2015, p. 36 (**Exhibit RF-208**).*

¹⁴²⁹ Furthermore, literature that was endorsed by the Tribunal confirms that abusive taxes are subject to the claw-back of Article 21(5) ECT. See Final Awards, marginal 1423. This means, by definition, that abusive taxation measures fall within the scope of Article 21(1) ECT.

¹⁴³⁰ See also Writ, §§ 295-296, SoR, §§ 302-305 and 308.

¹⁴³¹ SoA, § 743.

¹⁴³² See §§ 824-830 below.

“A taxation law is one which imposes a liability on classes of persons to pay money to the State for public purposes. The economic impacts or effects of tax measures may be unclear and debatable; nonetheless a measure is a taxation measure if it is part of the regime for the imposition of a tax. A measure providing relief from taxation is a taxation measure just as much as a measure imposing the tax in the first place” [emphasis added].¹⁴³³

821. Instead of focussing its determination on whether the Russian tax measures were adopted in good faith, the criterion that the Tribunal should have applied in determining whether a measure falls within the scope of the carve-out in Article 21(1) ECT, is whether the measure is sufficiently clearly connected to a taxation law or regulation (or a procedure, requirement or practice of the tax authorities in apparent reliance on such a law or regulation).¹⁴³⁴ According to established case law, a measure falls outside the scope of the carve-out only if such measure is “unsupported by any provision of the law of the host State”.¹⁴³⁵
822. There simply is no basis for the position that the taxation measures imposed upon Yukos Oil by the Russian Federation and contested by HVY were unsupported by any provision of Russian law (as the law of the host State). On the contrary, the Tribunal (a) confirmed that the bad faith taxpayer doctrine Yukos’ tax assessments were based on existed at the time the assessments were made, (b) indicated that HVY confirmed the existence of this doctrine, (c) upheld the assessments on Yukos’ trading shells in Lesnoy and Trekhgorniy, (d) confirmed that, as such, the VAT assessments imposed on Yukos were in conformity with applicable Russian law, and (e) acknowledged that the Russian tax courts involved assessed the correctness of these measures against the applicable tax laws and case law.¹⁴³⁶

¹⁴³³ *EnCana v Ecuador*, § 142(4). [English original text]: “The economic impacts or effects of tax measures may be unclear and debatable; nonetheless a measure is a taxation measure if it is part of the regime for the imposition of a tax. A measure providing relief from taxation is a taxation measure just as much as a measure imposing the tax in the first place”.

¹⁴³⁴ See Writ, §§ 297-298, with reference to *EnCana v. Ecuador* (R-328): “sufficiently clearly connected to a taxation law or regulation (or to a procedure, requirement or practice of the taxation authorities in apparent reliance on such a law or regulation)”. HVY’s assertion that the Russian Federation’s position entails that a Contracting Party is entitled to simply designate a measure as taxation measure in order to benefit from the carve-out, see SoA, § 743, must be rejected. The criterion developed in the case law is based on the objective nature of the measure, not on identification and/or labelling of a measure as a tax, see SoR, §§ 300-301 and 310.

¹⁴³⁵ Writ, §§ 297-298, with reference to *EnCana v. Ecuador* (R-328). The use of powers in bad faith may also be covered by such a carve-out, see Writ, § 299, SoR, §§ 311-313, with reference to *Burlington v. Ecuador* (RME-992).

¹⁴³⁶ Writ, § 300. See also Final Awards, marginal nos. 494, 593-598 and 611.

823. Therefore, the measures of the Russian Federation were clearly connected with (the application of) a tax law or regulation, thereby qualifying them as “taxation measures” for the purposes of Article 21(1) ECT. If the Tribunal had applied the correct standard, it should have declared that it has no jurisdiction over HVY’s claims.

(g) *Even on the basis of the incorrect standard applied by the Tribunal, the taxation measures of the Russian Federation are subject to the carve-out of Article 21(1) ECT*

824. Even if the incorrect standard of the Tribunal were to be applied, the Tribunal still wrongly held that the Russian Federation’s taxation measures were motivated by a purpose extraneous to taxation rather than by the purpose of generating public revenue.¹⁴³⁷

825. First of all, the Tribunal’s findings confirm that the Russian Federation’s taxation measures were based on numerous provisions and principles of Russian tax law aimed at generating government revenue.¹⁴³⁸ For example, the Tribunal established, among other things, that (i) the investigation into Yukos’ trading shells in Lesnoy and Trekhgornyy was based on the good faith taxpayer doctrine, which in any case existed since 2002 and was at that time applied in unrelated cases and (ii) the tax assessments imposed on Yukos were based on generally accepted principles of Russian tax law.¹⁴³⁹ The Tribunal also found that (a) no other company breached and abused the tax law regimes as Yukos did, (b) that Yukos was aware of the illegality of its scheme, (c) that Yukos actively sought to prevent the discovery of its scheme and (d) that Yukos expected that the discovery of its scheme would lead to substantial tax claims, losses and even criminal liability.¹⁴⁴⁰ It has furthermore been

¹⁴³⁷ The Russian Federation remarks that if relevance should attach to the subjective motivations of the Russian Federation, that is to say of its officials, inspectors, politicians and/courts, for the assessment whether its measures are covered by the carve-out of Article 21(1) ECT, this Court of Appeal should consider all of the Russian Federation’s presented facts and circumstances in its decision, so that justice will be done to the full review of the ground for setting aside under Article 1065(1)(a) DCCP, see SoR §§ 315-316.

¹⁴³⁸ Writ, §§ 305-314, SoR, § 320, with various references to sources in the Final Awards. Furthermore, it follows from the Final Awards that, according to the Tribunal, the measures of the Russian Federation were indeed also aimed at raising taxes, see Final Awards, marginal 1614.

¹⁴³⁹ Writ, §§ 305-308, SoR, § 320, with references to Final Awards, marginal nos. 318-319, 494, 497, 498, 593, 611, 614, 668, 670, 1611.

¹⁴⁴⁰ Writ, §§ 310-314, SoR, § 320, with references to Final Awards, marginal nos. 405, 488-489, 491, 494, 511, 513-515, 604, 1611.

established that the Russian tax court reviewed and approved the additional assessments ‘as taxation measures’ at multiple levels and for different years.¹⁴⁴¹

826. Second, the Tribunal overlooked important evidence and overruled applicable Russian law, as shown in the expert evidence of Mr Konnov, which was not contested by an expert of HVY. For instance, the Tribunal based its opinion that the taxation measures imposed on Yukos were not supported by Russian law and were imposed for a purpose extraneous to taxation, on three incorrect conclusions:

- (a) that the Russian Federation failed to submit any evidence demonstrating that the Mordovian entities were shams, and that the Russian authorities had been informed by Yukos, but that no one objected to its Mordovian tax scheme;
- (b) that there was no precedent for the attribution to Yukos of the revenue of its trading shells; and
- (c) that Yukos’ VAT assessments were improper.¹⁴⁴²

827. The evidence in respect of Yukos’ Mordovian entities that was overlooked by the Tribunal, which shall be discussed in greater detail in Section VI.D below, included documents showing (a) that Yukos used straw-men to act as the nominal directors of the Mordovian trading shells, (b) that the Mordovian trading shells had no (or virtually no) assets or employees and did not carry out any real activities, (c) that these trading shells were managed by Yukos from Moscow, (d) that the group structure was constantly changed by Yukos for no apparent economic reason, (e) that there was an enormous disproportion between the tax benefits obtained by these trading shells and the local investments they made, (f) that Yukos’ own managers and its accountant warned for additional tax assessments and criminal prosecution if its constructions in the low-tax regions would become known and (g) that Yukos was concerned about the legality of its constructions and kept tabs on the tax audits with regard to these trading shells.¹⁴⁴³

¹⁴⁴¹ See §§ 593-599 above.

¹⁴⁴² Writ, § 315.

¹⁴⁴³ Writ, §§ 316-324, and in particular §§ (h)-1080 below, with several references to the Final Awards and the case file in the Arbitrations.

828. In addition, the Tribunal wrongly held that the attribution of the income of its trading shells to Yukos was wrong, for lack of – according to the Tribunal – a Russian precedent at the time of the tax assessment. This reasoning does not hold water, because:

- (a) there is no such thing as re-attribution because it concerns attribution to Yukos of the revenues and profits of its own business operations;
- (b) in the reasoning of the Tribunal, no judicial remedy for the evasion or abuse of tax rules could be taken anymore, because the first application of that remedy would always lack a precedent, and the second attempt would always be another first attempt, and so on and so forth;
- (c) Mr Konnov, the expert of the Russian Federation, testified (without any expert from HVY contesting his report) that there certainly was Russian precedent for this remedy;¹⁴⁴⁴
- (d) the Tribunal wrongly failed to take account of Yukos’ acknowledgement that disclosing Yukos’ affiliation with its sham trading shells (that were wrongly presented as independent trading partners) would result in substantial tax claims against Yukos; and
- (e) the Tribunal has ignored a tax commentary written by Yukos’ own tax counsel confirming that the measures taken by the Russian Federation were based on Russian law.¹⁴⁴⁵

829. Moreover, the Tribunal wrongly held that Yukos’ VAT assessment were improper because the Russian authorities refused, for “purely technical reasons”,¹⁴⁴⁶ to attribute to Yukos the trading companies’ VAT returns. For instance, Mr Konnov testified and substantiated indisputably (i) that the requirement that a monthly VAT filing must be made by the true taxpayer in order to claim a VAT refund was applied generally by the Russian tax authorities, and was justified by important administrative considerations, (ii) that Yukos could have avoided most of its VAT assessments by filing properly amended monthly VAT returns (iii) that Yukos nonetheless – to avoid the influence thereof on the sanctioning of its evasion of profit tax along the same routes – chose not to file properly amended VAT

¹⁴⁴⁴ See for instance Konnov Report 1, §§ 39-52, and Konnov Report 2, §§ 18-26.

¹⁴⁴⁵ Writ, §§ 325-334, with various references to the Final Awards and the case file in the Arbitrations.

¹⁴⁴⁶ Final Awards, marginal 626.

returns.¹⁴⁴⁷ As will be set out below, not only in the Russian Federation but nearly everywhere, VAT rules are being interpreted and applied in a strictly formal and mechanistic way. Therefore, in several other jurisdictions “purely technical reasons” can equally be invoked against taxpayers.¹⁴⁴⁸ Furthermore, it is entirely uncertain, and in any event was not proven (through transport documents or other proof of export or payment) by Yukos at that time¹⁴⁴⁹ (and also not by HVY thereafter) that the oil allegedly exported according to its sham companies’ VAT returns actually ended up abroad.¹⁴⁵⁰

830. By ignoring evidence and starting from untenable – at times even purely speculative – opinions about Russian tax law, the Tribunal wrongly arrived at the opinion that the measures do not constitute a *bona fide* exercise of the Russian Federation’s taxation power and thus fall outside of the carve-out of Article 21(1) ECT.¹⁴⁵¹ This opinion about a lack of legitimacy and about speculative ill will cannot be upheld. For this reason, the second of two separate reasons¹⁴⁵² based on which the Tribunal believed to have jurisdiction in respect of the Russian Federation’s taxation measures lacks merit as well.

(h) ***The ECtHR judgments in 2011 and 2013 confirm that the measures of the Russian Federation concerned a legitimate exercise of the Russian Federation’s power to levy taxes***

831. Moreover, the Tribunal’s rulings are contrary to the unanimous decisions of two separate Chambers of the ECtHR.¹⁴⁵³ Both decisions have also been upheld by the Grand Chamber

¹⁴⁴⁷ Writ, §§ 335-341, with various references to the Final Awards and the case file in the Arbitrations. The later return submitted by Yukos itself lacked any evidence concerning the transactions invoked and the export of the oil allegedly supplied in that respect. Furthermore, the Tribunal wrongly speculated that even if Yukos had filed the required monthly VAT return, the Russian Federation would have done all it could to ensure that Yukos would be subjected to VAT. There is no basis in the case file for the Tribunal’s unsupported, insinuating speculation. See Writ, § 342.

¹⁴⁴⁸ Writ, §§ 360-361, with several references to case law and literature, in particular to Respondent’s Counter-Memorial, §§ 1204-1214. See also § 837 below.

¹⁴⁴⁹ The ECtHR ruled, for example, that Yukos “*failed to submit any proof that it had made a properly substantiated filing in accordance with the established procedure (...)*”, see First ECtHR Ruling, § 602.

¹⁴⁵⁰ Cf. the ruling of the Russian Court, adopted by the ECtHR, that Yukos “*had failed to submit a proper claim with monthly calculations and evidence and that the goods in question had indeed been exported*”, First ECtHR Ruling, § 216.

¹⁴⁵¹ Final Awards, marginal nos. 1430-1445. See also Writ, §§ 302-343.

¹⁴⁵² Final Awards, marginal 1406; see also § 783 above.

¹⁴⁵³ See also Writ, §§ 344-350, SoR, §§ 317-319, with various references to the First ECtHR Ruling and Second ECtHR Ruling. §§ 588-606 of the First ECtHR Ruling are particularly relevant in this context.

of the ECtHR, after a fruitless appeal lodged by Yukos Oil and Khodorkovsky, respectively.

832. The ECtHR ruled that Yukos evaded taxes on a massive scale and concluded that the measures taken by the Russian Federation were a legitimate and proportionate exercise of its powers and were not dictated by an “improper motive”.¹⁴⁵⁴ The ECtHR’s ruling with regard to Yukos’ corporate profit tax and VAT assessments confirm that these measures were based on established principles of Russian tax law. In particular, the ECtHR found (a) that the case files for all of the low-tax regions, Mordovia not excepted, included abundant evidence showing that all of Yukos’ trading shells were shams; (b) that attributing to Yukos the tax consequences of its own actions was neither an unprecedented remedy nor abused by the Russian Federation to bankrupt Yukos; and (c) that Russian law clearly required Yukos to file a properly amended and fully documented VAT return in its own name and that Yukos was not singled out for invidious treatment.¹⁴⁵⁵ Established case law dictates that the Dutch court has to follow this interpretation by the ECtHR.¹⁴⁵⁶
833. HVY’s assertions that the review under Article 6 ECHR is different from that under Article 13 ECT, that the ECtHR prioritises the authority of a State and assesses its actions on a separate basis instead of in their mutual conjunction, that the ECtHR dealt with an entirely different case file,¹⁴⁵⁷ and that the ECtHR has identified violations of the ECHR in certain respects¹⁴⁵⁸ are incorrect, and in any event do not detract from the ECtHR’s aforementioned ruling that the Russian Federation’s taxation measures were a legitimate

¹⁴⁵⁴ Writ, § 344, with reference to the First and Second ECtHR Ruling.

¹⁴⁵⁵ Writ, §§ 346-348.

¹⁴⁵⁶ Pleading Notes RF, § 56, with reference to, *inter alia*, ECtHR 9 June 2009 Appl. No. 33401/02, RvdW 2009, 1291, § 163 (*Opuz v. Turkey*) and Supreme Court 10 August 2001, NJ 2002/278 (*Family Life*), ground 3.7.1 et seq. See also Amsterdam Court of Appeal 9 May 2017, ECLI:NL:GHAMS:2017:1695 (*Yukos Finance*), ground 4.18.2.

¹⁴⁵⁷ HVY fail to address specific differences between the respective case files (the general assertion that the ECtHR “*did not hear any witnesses and experts itself and therefore much less evidence was available to it than to the Tribunal*” is insufficient and unconvincing), and HVY also do not indicate that those differences would have led to an entirely different outcome before the ECtHR. HVY’s reference in SoA, § 747 to SoD, Part II, section 6.2 is furthermore misleading, because that section certainly does not explain why according to HVY the ECtHR had an entirely different case file before it. HVY’s argument therefore must fail.

¹⁴⁵⁸ SoA §§ 746-747. The Russian Federation furthermore disputes the relevance of HVY’s assertion that it emerges from the Russian Federation’s actions that it does not concur with the ECtHR’s ruling, see SoA, § 747. Be that as it may, the legitimacy of the ECtHR’s rulings cannot be compromised by any actions of the parties.

and proportionate exercise of its taxation powers and were not dictated by an improper motive.¹⁴⁵⁹

834. The Tribunal ignored the findings of the ECtHR and instead derived support from the final awards rendered in *RosInvestCo. v. Russian Federation* and *Quasar de Valores et al. v. Russian Federation* – both of which have meanwhile been definitively quashed by the Swedish courts.¹⁴⁶⁰ In any event, both rulings pertain to a bilateral investment treaty that, in contrast to the ECT, does not contain a taxation carve-out and are not relevant in any other way either.¹⁴⁶¹

(i) ***The measures of the Russian Federation are consistent with internationally recognised tax policies and practices, including those of the Netherlands***

835. The taxation measures of the Russian Federation are consistent with internationally recognised tax policies and practices, including those of the Netherlands

836. Broad consensus exists among national tax authorities and courts across jurisdictions that anti-tax avoidance rules, akin to the bad faith taxpayer doctrine relied upon by the tax authorities, would be illusory if the real party in interest could not be held liable for the tax consequences of the actions taken by sham entities they own or control.¹⁴⁶² The Tribunal has acknowledged this as well, making reference to countries such as the United States, France, Germany, Canada and Australia.¹⁴⁶³ In the Netherlands, the *fraus legis* doctrine serves as the basis to re-characterise transactions predominantly aimed at avoiding taxes in a manner that is contrary to the purpose of the tax law. Based on this doctrine, the income in question is attributed to the real party in interest. The tax authorities in the Netherlands would thus be entitled, like the Russian authorities, to re-characterise Yukos' tax scheme

¹⁴⁵⁹ See also SoA, §§ 318-319.

¹⁴⁶⁰ Judgment of the Svea Court of Appeal, *The Russian Federation v. RosInvestCo UK Ltd.*, Case No. T 10060-10 5 September 2013); Judgment of the Svea Court of Appeal, *The Russian Federation v. GBI 9000 SICAV S.A., ALOS 34 S.L., Orgor de Valores SICAV S.A., Quasar de Valores SICAV S.A.*, Case No. T 9128-14 (18 January 2016).

¹⁴⁶¹ Writ, § 349, SoR, §§ 306-307, Pleading Notes RF § 2.

¹⁴⁶² Writ, § 352, with further references.

¹⁴⁶³ Final Awards, marginal 625.

and to attribute to Yukos the income realised from the transactions nominally carried out by the sham trading shells.¹⁴⁶⁴

837. Moreover, many countries, including New Zealand, United Kingdom, Belgium, France, Germany, Italy and Sweden, levy VAT in a strictly formal and mechanistic way, so as to facilitate a simple and efficient tax administration.¹⁴⁶⁵ For example, the Dutch tax authorities and courts have denied the zero VAT rate for exports where the taxpayer did not substantiate its claim with sufficient documentation, even if it would otherwise be entitled to the claimed exemption. A Dutch court would almost certainly have upheld Yukos' VAT assessment based on its incorrect filing of annual VAT returns rather than the monthly returns required under Russian law.¹⁴⁶⁶

(j) ***Conclusion: on the basis of Article 21 ECT, the Tribunal had no jurisdiction in respect of HVY's claims***

838. The foregoing demonstrates that:

- (a) a tribunal appointed on the basis of Article 26 ECT has no jurisdiction in respect of claims based on taxation measures (see §§ 787-792 above);
- (b) the notion "taxation measure" covers any legislative, executive or collecting action relating to taxes (see §§ 793-800 above);
- (c) the notion of "taxes" does not include executive and collection measures and the Tribunal wrongly ruled that any taxation measure that falls outside of the scope of the ECT on the basis of Article 21(1) is brought back within the scope of the ECT because of the claw-back for expropriating taxes contained in Article 21(5) in conjunction with Article 13 ECT (see §§ 801-812 above);
- (d) the contested measures of the Russian Federation are taxation measures but not taxes (see §§ 813-816 above);
- (e) the correct standard is that the carve-out of Article 21(1) ECT applies to any measure that is sufficiently clearly connected to a taxation law or regulation, and the measures of the Russian Federation clearly satisfied this requirement. Irrelevant in this respect is whether the taxation measure in

¹⁴⁶⁴ Writ, §§ 352-359, with various references to case law and literature.

¹⁴⁶⁵ Writ, § 360, referring to Respondent's Counter Memorial on the Merits, §§ 1204-1214.

¹⁴⁶⁶ Writ, §§ 360-361, with various references to case law and literature.

UNOFFICIAL TRANSLATION

This text is an unofficial translation of the Dutch original. In case of any discrepancies, the Dutch original shall prevail.

question might be based on a legally incorrect interpretation of the objective tax law and/or that the tax official or court in question had an additional subjective motive to prejudice the tax subject in question (see §§ 817-823 above);

- (f) even under the incorrect standards applied by the Tribunal, the taxation measures of the Russian Federation fall under the carve-out of Article 21(1) ECT because these were based on provisions and established principles of Russian tax law for the purpose of raising public revenue (see §§ 824-830 above);
- (g) the ECtHR judgments confirm that the measures of the Russian Federation concerned a legitimate exercise of the Russian Federation's power to levy taxes (see §§ 831-834 above); and
- (h) the measures of the Russian Federation are consistent with internationally recognised tax policies and principles, including those of the Netherlands (see §§ 835-837 above).

839. Accordingly, in light of Article 21 ECT, the Tribunal wrongly assumed jurisdiction in respect of HVY's claims. For this reason, the Yukos Awards must be set aside on the basis of Article 1065(1)(a) DCCP.

V. GROUNDS FOR SETTING ASIDE 2 AND 3 - NON-COMPLIANCE WITH THE MANDATE OF THE ARBITRAL TRIBUNAL AND THE COMPOSITION OF THE ARBITRAL TRIBUNAL (ARTICLE 1065(1)(C) AND (B) DCCP)

A. Introduction

840. As stated above, this Court of Appeal may also, either immediately or in addition or instead, hear and rule on the respondent's other grounds of action still remaining as a result of the devolutive effect of the appeal proceedings. In the unlikely event that this Court of Appeal first addresses HVY's grounds for appeal and finds that the District Court wrongly set aside the Yukos Awards on the basis of its interpretation of Article 45 ECT and the consequence lack of jurisdiction of the Tribunal, the below grounds for setting aside will be discussed again on the basis of the devolutive effect of the appeal proceedings. The Russian Federation has invoked the ground for setting aside 'non-compliance with the mandate' (Article 1065(1)(c) DCCP) and the composition of the Arbitral Tribunal (Article 1065(1)(b) DCCP).¹⁴⁶⁷ The non-compliance with the mandate relates to the following points:

- (a) The Arbitral Tribunal has not complied with its mandate by not referring the expropriation dispute to the competent tax authorities (Mandate Ground 1);
- (b) The Arbitral Tribunal has taken a surprise decision by using an own method for estimating the damages and not hearing the parties thereon (Mandate Ground 2);
- (c) The Arbitrators have not performed their mandate personally (Mandate Ground 3) and which resulted in an incorrect composition of the Arbitral Tribunal (Ground for setting aside 3).

B. Legal framework

841. The mandate of the arbitral tribunal has a formal and a substantive side. The formal side of the mandate relates to the statutory and agreed procedural rules that an arbitral tribunal

¹⁴⁶⁷ Writ Grounds 2 and 3.

must observe. The substantive side of the mandate relates to, inter alia, the limits of the legal battle.¹⁴⁶⁸

842. Despite the cautious review of this ground, the judges have not hesitated to set aside various arbitral awards on account of non-compliance with the mandate.¹⁴⁶⁹

843. In the present case, there has been non-compliance with the formal mandate and the substantive mandate. In view of the setting-aside grounds advanced by the Russian Federation, this Court of Appeal shall set aside the Yukos Awards on the basis of Article 1065(1)(c) DCCP. This Court of Appeal need not confine itself to a discussion of the grounds for appeal of the appellant. The Court of Appeal may also immediately, or in addition thereto, or instead thereof, proceed to a discussion and decision on the, based on the devolutive effect of the appeal, still remaining basis of the claim of the respondent.¹⁴⁷⁰ So the case can already be decided on the basis of one of the violations of the mandate.

C. Mandate Ground 1 - The Tribunal has failed to refer the expropriation dispute to the competent tax authorities

The Russian Federation refers to:		
<u>Arbitrations:</u>		
Final Awards	Chapter IX.C.4.b.2	marginal nos. 1421-1423, 1426-1428, 1435
<u>Setting aside proceedings:</u>		
Writ	Chapter V.C	§§ 368 - 385
SoD	Part I, Chapter 3.4.2	§§ I.133 - 143
	Part II, Chapter 3.10	§§ II.459 - 490
SoR	Chapter IV.C	§§ 328 - 366
SoRej	Chapter 3.2	§§ 250 – 274, 428, 431
RF Pleading Notes	Chapter V.I	§§ 66 - 75
HVY Pleading Notes	Chapter 2.1 and 2.3	§§ 81-87, 95-98
SoA	Part II, Chapter 10.3 and 10.4	§§ 750-768
Primary exhibits:		
<u>Arbitrations:</u>		
C-944		<i>Canada – Import Restrictions on Ice Cream and Yoghurt</i> , Report of the GATT Panel adopted at the Forty-fifth Session of the Contracting Parties on

¹⁴⁶⁸ See for a further explanation of the Writ, Chapter V (Ground 2), part B (Legal framework) and SoR, Chapter IV (Ground 2), part B (Legal framework).

¹⁴⁶⁹ In addition to the eight examples in SoR, footnote 569, see: District Court Oost-Brabant, 31 August 2016, ECLI:NL:RBOBR:2016:4862 and Court of Appeal Den-Bosch, 22 November 2016, ECLI:NL:GHSHE:2016:5201 (*Slachthuis / UCS Cleaning*).

¹⁴⁷⁰ See, *inter alia*, Bakels et al., Asser Procesrecht 4, Appeal, no. 134. See also Snijders/Wendels, Civil Appeal, no. 218.

UNOFFICIAL TRANSLATION

This text is an unofficial translation of the Dutch original. In case of any discrepancies, the Dutch original shall prevail.

	December 5, 1989.
RME-2873	<i>Wintershall Aktiengesellschaft v. Argentine Republic</i> , ICSID Case No. ARB/04/14, Award (2 December 2008), § 119
RME-3576 (RF-03.2.C-2.3576)	<i>BG Group Plc v. Argentina</i> , UNCITRAL, Award (Dec. 24, 2007)
<u>Setting aside proceedings:</u>	
RF-78	<i>Garanti Koza LLP v. Turkmenistan</i> , ICSID Case No. ARB/11/20, Decision on the Objection to Jurisdiction for Lack of Consent of July 3, 2013
RF-79	<i>Urbaser S.A. and Consorcio de Aguas Bilbao Biskaia, Bilbao Biskaia Ur Partzuergoa v. Argentine Republic</i> , ICSID Case No. ARB/07/26, Decision on Jurisdiction of December 19, 2012
RF-80	<i>ICS Inspection and Control Services Limited v. The Argentine Republic</i> , Award on Jurisdiction of February 10, 2012
RF-81	<i>Daimler Financial Services AG v. Argentine Republic</i> , ICSID Case No. ARB/05/1, Award of August 22, 2012
RF-82	<i>Ambiente Ufficio S.P.A. and Others v. Argentine Republic</i> , ICSID Case No. ARB/08/9, Decision on Jurisdiction and Admissibility of February 8, 2013
RF-208	S. Nappert, 'The Yukos Awards - A Comment', <i>The Journal of Damages in International Arbitration</i> , Vol. 2, 2015, No. 2.
RF-209	S. Nappert, 'Square Pegs and Round Holes: The Taxation Provision of the Energy Charter Treaty and the Yukos Awards', in: <i>Cahiers de l'arbitrage</i> , 1 January 2015, no. 1, p. 7 e.v.

Essence of the argument

- The Tribunal has refused, in violation of its mandate, to refer the dispute for advice to the competent tax authorities.
- Article 21(5) ECT contains a mandatory (referral) obligation: “shall make a referral to the relevant Competent Tax Authorities”.
- Advice would have been useful and appropriate; there is no such thing as a futility exception, and it would in any event not hold here.
- The Russian Federation explicitly pointed out the necessity and importance of the application of Article 21(5) ECT and it did so in good time.
- Referrals and timely advice were certainly possible during the Arbitrations lasting 10 years.
- The parties have also been deprived of the opportunity to invoke the advice of the tax authorities or otherwise express their views thereon, which is also contrary to the public policy.

(a) *Introduction*

844. The Tribunal has refused, in violation of its mandate, to refer the dispute for advice to the competent tax authorities. The Tribunal was obliged to do the same pursuant to Article 21(5) ECT. The relevant treaty provision does not grant the Tribunal any discretionary powers and does also not contain any other exception that could justify the refusal to refer the dispute to the competent tax authorities for advice. The ECT provides only one procedural prescription specific to an arbitral tribunal, and this is exactly the one that the Tribunal knowingly and deliberately violated.

845. The Russian Federation maintains in its entirety the substantiation given in the first instance for this setting-aside ground of non-compliance with the mandate (Article 1065(1)(c) DCCP).¹⁴⁷¹ For the convenience of this Court of Appeal, the Russian Federation will in this chapter, without prejudice to the devolutive effect of the appeal, once again give the essence of its previous argument in this respect. It will supplement this with the refutation of what has been advanced as defence by HVY in this respect before, in and with their Statement of Appeal.¹⁴⁷²

(b) *The provisions of Article 21(5) ECT*

846. Article 21(5) ECT prescribes a procedure that must be completed when, in the context of Article 13 ECT, a dispute arises on the question of whether a form of tax constitutes expropriation or is discriminatory. If the parties have not yet done so themselves, this dispute must then be referred by the tribunal to the competent tax authorities. This is explicitly and unequivocally set out in Article 21(5)(b)(i) ECT:

5. a Article 13 [expropriation] shall apply to taxes.

5. b. Whenever an issue arises under Article 13, to the extent it pertains to whether a tax constitutes an expropriation or whether a tax alleged to constitute an expropriation is discriminatory, the following provisions shall apply:

5. b (i). The investor or the Contracting Party alleging expropriation shall refer the issue of whether the tax is an expropriation or whether the tax is discriminatory to the relevant Competent Tax Authorities. Failing such referral by the Investor or the Contracting Party, bodies called upon to settle

¹⁴⁷¹ Writ, Chapter V.C, and SoR, Chapter IV.C.

¹⁴⁷² If a defence is new, this will be indicated.

disputes pursuant to Article 26(2)(c) or 27(2) shall make a referral to the relevant Competent Tax Authorities.¹⁴⁷³

847. The wording of Article 21(5) ECT imply a mandatory *obligation*. This follows from the use of the word "*shall*" in the authentic English text:

"(...) bodies called upon to settle disputes (...) shall make a referral to the relevant Competent Tax Authorities."¹⁴⁷⁴

848. The provision leaves no room for a discretionary assessment.¹⁴⁷⁵ The renowned arbitrator Sophie Nappert is of the opinion that the text of the provision makes clear that the reference is mandatory:

"The language leaves no doubt that the ECT Contracting Parties intended that referral is to be mandatory".¹⁴⁷⁶

(c) ***History, object and scope of Article 21(5) ECT***

849. In the course of the drafting of the Treaty, Article 21 ECT was subject to lengthy negotiations. The scheme of Article 21(5) ECT was taken from and tailored to the treaties aimed at the prevention of double taxation.¹⁴⁷⁷ The OECD Model Conventions provide for 'mutual consultation procedures' in which the relevant tax authorities enter into consultations with each other (*Mutual Agreement Procedure*).¹⁴⁷⁸ The details of the system¹⁴⁷⁹ of Article 21(5) ECT reveal that the negotiating parties were extremely concerned with such forms of consultation.

¹⁴⁷³ Underlining and text between brackets added.

¹⁴⁷⁴ Emphasis added. The Dutch text is as follows: "*(...) dan leggen de instanties (...), het geschil voor aan de bevoegde belastingautoriteiten*". See Writ, § 373 and SoR, § 339. And as regards the question of whether a tax is discriminatory, it also applies that the Tribunal must be take the advice into account in its decision (Article 21(5)(b) (iii) ECT): "*(...) Such bodies shall take into account (...)*." [emphasis added]

¹⁴⁷⁵ In several arbitral awards, arbitral tribunals have confirmed that the use of the word "*shall*" in BITs is "*legally binding*". For example, the arbitral tribunal in *Wintershall v. Argentina* ICSID ARB/04/14, Award dated 8 December 2008, paragraph 119 (Exhibit RME-2873) (**Exhibit RF-03**). See also the references to arbitral awards given at footnote 523 of the Writ and footnote 587 of the SoR.

¹⁴⁷⁶ See Sophie Nappert, 'The Yukos Awards - A Comment', *Journal of Damages in International Arbitration*, 2015, p. 34 (**Exhibit RF-208**).

¹⁴⁷⁷ Respondent's Rejoinder on the Merits, § 339. Most of these bilateral treaties are based on the various versions of the *OESO Model Tax Convention*.

¹⁴⁷⁸ As referred to in Article 25 of the *OECD Model Tax Convention*. See also Article 25 of the bilateral treaties for the avoidance of double taxation between the Russian Federation and Cyprus, and the Russian Federation and the United Kingdom. See also, for example, Article 2103 (6) NAFTA.

¹⁴⁷⁹ Cf. Also Sophie Nappert, 'The Yukos Awards - A Comment', *Journal of Damages in International Arbitration*, 2015, p. 34: "*The length and wording of Article 21, and its specific prevailing nature over*

850. Article 21(5) ECT constitutes a guarantee that prevents an arbitral tribunal to decide on the question of whether a tax must be characterised as an expropriation or as discriminatory without the relevant authorities having had the opportunity to express their views thereon. Article 21(5) ECT is thus designed to guarantee the position of the tax authorities and the sovereign nature of taxation, which is essential for states.¹⁴⁸⁰
851. Article 21(5) ECT is also designed to support arbitral tribunals.¹⁴⁸¹ Arbitrators can seldom boast special expertise in terms of tax law, let alone tax law in jurisdictions foreign to them. The technical nature of tax legislation and the significant differences between jurisdictions making it worthwhile and necessary to obtain information from those tax authorities that are most involved and that have the most expertise.
852. Article 21(5) ECT is not only about a formal requirement, but stipulates an obligation that belongs to the core of the mandate of an ECT arbitral tribunal. After all, the referral mechanism guarantees that an arbitral tribunal receives information based on the knowledge and experience of the competent tax authorities who are most connected with the relevant dispute. This therefore ensures both the essential sovereign nature of taxation and the quality of the expert advice before an arbitral tribunal proceeds to assess such a tax dispute.

(d) *Course of proceedings and Tribunal's decision*

853. The text of Article 21(5) is clear. The Tribunal should have referred the dispute to the tax authorities of Cyprus, the United Kingdom and the Russian Federation.¹⁴⁸²

*other provisions, speak volumes as to its importance for the ECT Contracting Parties". (**Exhibit RF-208**).*

¹⁴⁸⁰ As even HVY itself argued in the Arbitrations in regard to Article 21: "*this provision ensures that the Contracting Parties are able to freely determine their fiscal policies*". Claimant's Reply on the Merits, § 997.

¹⁴⁸¹ This is particularly true on the question of whether tax law is being abused. The Tribunal also recognizes that "*Article 21(5) was designed to assist tribunals 'to distinguish normal and abusive taxes*". See Final Awards, marginal 1423.

¹⁴⁸² This follows from Article 21(7)(c) ECT, and even the Tribunal itself is – in principle – of the same opinion (Final Awards, marginal 1421); see also Transcript Hearing on the Merits, Day 21, 191, 193 (**Exhibit RF-03**).

854. The Russian Federation has explicitly alerted the Tribunal to the requirement and sense of the referral obligation.¹⁴⁸³ See below a time line with procedural documents in which the Russian Federation requested referral:

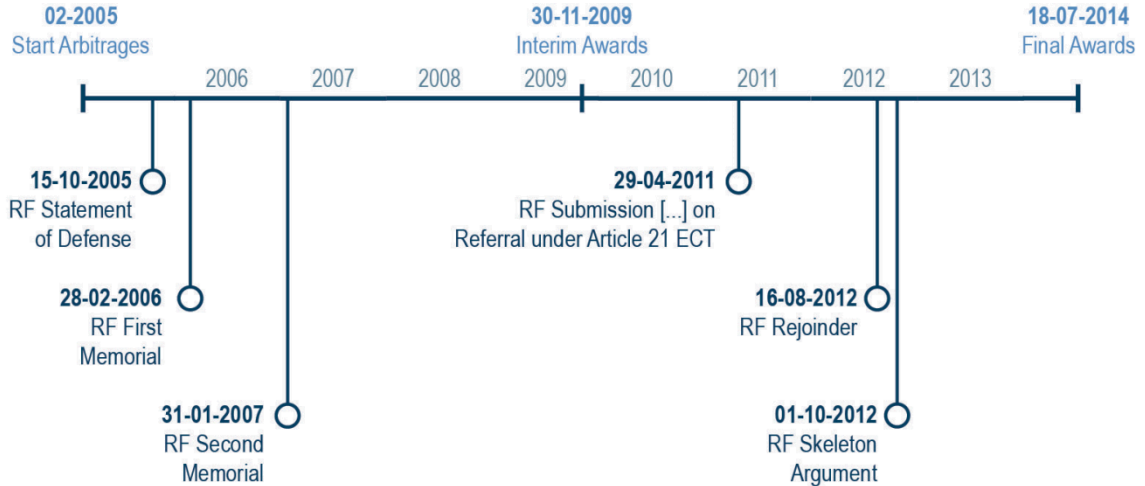

855. The Russian Federation expected much from this. The Russian tax authorities could have clarified the Russian law. More importantly perhaps, the tax authorities of Cyprus and the United Kingdom could have *confirmed* that the alleged tax assessments had been imposed in accordance with internationally accepted standards.

856. In addition, there was more than sufficient time in the Arbitrations to refer the tax points in dispute to the competent tax authorities for advice, as the Arbitrations lasted almost 10 years. Such a procedure to obtain advice would not have resulted in any delay or disruption of due process of law. On the contrary: by initiating such a procedure to obtain advice, the Tribunal could have prevented many unnecessary debates on the content and the regular application of the Russian tax law.

857. Notwithstanding the clear text of the only procedural rule set out in the ECT itself, the clear and reasoned demand of the Russian Federation to apply this rule, the abundance of time to submit the dispute to the competent tax authorities and the fact that questions on taxation

¹⁴⁸³ See, for example, Respondent's Short Submission on Bifurcation of Liability and Quantum, and on Referral under Article 21 ECT, 29 April 2011; Respondent's Statement of Defence, 15 October 2005, § 55; Respondent's First Memorial on Jurisdiction, 28 February 2006, §§ 132, 134; Respondent's Second Memorial, 31 January 2007, § 2; Respondent's Rejoinder on the Merits, 16 August 2012, §§ 293, 329-333; Respondent's Merits Skeleton Argument, 1 October 2012, § 73 (**Exhibit RF-03**).

were the pivotal issue in these proceedings¹⁴⁸⁴, the Tribunal believed that it was entitled to ignore the mandatory provision of Article 21(5) ECT. The Tribunal summarised this as follows:

- (a) Referring the expropriation dispute to the competent tax authorities would have been pointless ("*futile*"), because the file of the Arbitrations, given its size and complexity, could supposedly not be reduced to a sensible size and scope for the competent tax authorities,¹⁴⁸⁵
- (b) Referring the expropriation dispute to the competent tax authorities would have been pointless ("*futile*"), because they would then have focused on specific tax disputes instead of assessing the file in its entirety, as the Tribunal has done,¹⁴⁸⁶
- (c) The conclusions of in particular the Russian tax authorities would supposedly have had "*little value for an arbitral tribunal*" because they had supposedly participated in the measures against Yukos,¹⁴⁸⁷
- (d) Moreover, the competent tax authorities could only have issued an opinion that would not be binding on the Tribunal.¹⁴⁸⁸

858. In summary, the Tribunal considered that referral to the tax authorities would be an "*exercise in futility*" (i.e.: pointless)¹⁴⁸⁹:

"1428. In conclusion, the Tribunal holds that a referral of the dispute to the "Competent Tax Authorities" within the meaning of Article 21(5)(b)(i) of the ECT would clearly have been futile at the outset of this arbitration and was therefore not required. It remains futile today."¹⁴⁹⁰ [emphasis added]

¹⁴⁸⁴ As even the Tribunal itself acknowledged: HEL Interim Award, § 583 YUL Interim Award, § 584 and VPL Interim Award, § 595 "*The Tribunal observes that the background to, and motivation behind, the Russian Federation's measures that gave rise to the present arbitration, be they "Taxation Measures" or not, go to the heart of the present dispute.*" See also Final Awards, marginal 1401 "(...) *issues that went to the heart of the merits of the dispute*".

¹⁴⁸⁵ Final Awards, marginal nos. 1422-1423 and 1426.

¹⁴⁸⁶ Final Awards, marginal no. 1423.

¹⁴⁸⁷ Final Awards, marginal no. 1435.

¹⁴⁸⁸ Final Awards, marginal no. 1427.

¹⁴⁸⁹ For the bare reasoning underlying this position, see the Final Awards, marginal nos. 1421-1423, 1426-1428, 1435. See Writ. § 369 and SoR, § 329.

¹⁴⁹⁰ [English original text]: "*1428. In conclusion, the Tribunal holds that a referral of the dispute to the "Competent Tax Authorities" within the meaning of Article 21(5)(b)(i) of the ECT would clearly have been futile at the outset of this arbitration and was therefore not required. It remains futile today.*" [emphasis added]

(e) *Fallacies of the Tribunal; HVY's arguments cut no ice*

859. The refusal to comply with the mandatory rule of Article 21(5) ECT constitutes non-compliance with the mandate¹⁴⁹¹ and is contrary to the public policy¹⁴⁹², which non-compliance and contrariety are in themselves already sufficient to set aside the Yukos Awards. This non-compliance is certainly not justified by the sophisms that both the Tribunal and HVY have advanced.¹⁴⁹³

Ad (a): Article 21(5) does not contain a futility exception

860. In the first place, Article 21(5) ECT does not contain a "futility" exception¹⁴⁹⁴, as suggested by the Tribunal and HVY.¹⁴⁹⁵ The Treaty does not contain any exceptions, but only a mandatory referral obligation.¹⁴⁹⁶

861. Dutch arbitration law does not contain any statutory provision from which it follows that an arbitral tribunal can brush aside agreed procedural rules if the arbitral tribunal is of the opinion that the application of those rules does not lead to a different outcome or is otherwise useless. Contrary to what HVY argue¹⁴⁹⁷, such a rule does also not exist under international law. To substantiate their position, HVY¹⁴⁹⁸ and the Tribunal¹⁴⁹⁹ refer to case law that supposedly shows that following mandatory procedures (such as the mandatory exhaustion of national legal remedies, the observance of a cooling-down period and the requirement that an investor must apply to the national court of the treaty state before instituting arbitration proceedings) can be brushed aside if these procedures are useless ("a

¹⁴⁹¹ The tiered assessment of non-compliance with the mandate advocated by HVY (see SoD, Part II, § 30 and SoA, § 765) does not apply (see for the undisputed defence of the Russian Federation, SoR, Chapter IV (2), part B (Legal framework), §§ 325-327). If, with application of the cautious review, non-compliance is established, the arbitral award shall be set aside. It also does not matter here, because the non-compliance with the mandate in this case is serious anyway.

¹⁴⁹² Finally, the parties have also been deprived of the opportunity to invoke the advice of the tax authorities or otherwise express their views thereon, which is also contrary to the public policy (see SoD, § see DoA, §867 and Chapter VII.C, §1139).

¹⁴⁹³ See SoA, § 764.

¹⁴⁹⁴ See Writ, §§ 374-375 and SoR, §§ 336-340 and Pleading Notes RF, §§ 71-74.

¹⁴⁹⁵ Final Awards, marginal nos. 1422-1423, 1426; SoD.II §§ 467-478, SoRej., §§ 267-270.

¹⁴⁹⁶ See Writ, §§ 371-373 and SoR, §§ 339-340 and Pleading Notes RF, § 67.

¹⁴⁹⁷ SoA § 764. And see also Final Awards, marginal 1425.

¹⁴⁹⁸ See SoD, § 474.

¹⁴⁹⁹ Final Awards, footnotes 1864-1865.

futility"). These mandatory procedures in the case law cited by HVY are designed to first give anyone that has been held liable the opportunity to resolve any alleged violations of the law within the framework of its own legal system. These procedures are gateways that must be pursued by the Investor.¹⁵⁰⁰

862. However, the referral requirement has a different purpose. This obligation is designed to prevent that an arbitral tribunal decides on the question of whether a tax must be regarded as an expropriation or discriminatory, without the relevant tax authorities with the most expertise and experience having had the opportunity to express their views to the arbitral tribunal in a substantiated opinion. The case law cited by HVY to substantiate their argument thus relates to cases that differ fundamentally from the present case and is therefore irrelevant.¹⁵⁰¹ HVY have furthermore obviously not been able to advance a single example in which an arbitral tribunal has read a *futility* exception in a referral mechanism that is similar to Article 21(5)(b) ECT.¹⁵⁰² Nor did HVY present an example in which the relevant treaty itself provides for such an exception to an otherwise mandatory request for opinion.
863. Even if there were a general rule allowing arbitrators to shove aside the mandatory procedural law if the Tribunal fails to see its value (*quod non!*), it certainly cannot be invoked in this case.¹⁵⁰³ The large size of the case file¹⁵⁰⁴ is not an argument that is justified in this respect.¹⁵⁰⁵ After all, it is incomprehensible why the authorities would have to examine the entire file. It goes without saying that the authorities could confine themselves

¹⁵⁰⁰ S. Nappert, 'Square Pegs and Round Holes: The Taxation Provision of the Energy Charter Treaty and the Yukos Awards', in: *Cahiers de l'arbitrage*, 1 January 2015, no. 1, p. 8. (**Exhibit RF-209**): "*The Tribunals refer to Occidental Petroleum v Ecuador (cooling-off period); BG Group v Argentina (exhaustion of local remedies); Ambiente Ufficio v Argentina (recourse to the domestic courts for a limited time). However cooling-off periods and exhaustion of local remedies are "gateway" matters to be pursued by the investor only – rather like the veto nature of the reference to tax authorities in the NAFTA, for example. As set out above, the referral mechanism at Article 21 is of a different nature. It must be taken up by the tribunal if the investor fails to do so, because it serves to provide input from the tax authorities into the tribunal's ultimate finding on expropriation, particularly on any discriminatory element thereof, on the basis of cultural and policy considerations. In the Yukos Awards, where Russian investors acting through foreign corporate entities were in effect taking their home State to arbitration, these considerations were especially warranted. In the event they were not requested.*"

¹⁵⁰¹ See Writ, §§ 374-375.

¹⁵⁰² SoR, § 340.

¹⁵⁰³ See, *inter alia*, Writ, §§ 374, 375. The Russian Federation disputes SoRej. § 270.

¹⁵⁰⁴ Final Awards, marginal no. 1422; SoD, Part II, §§ 479-482.

¹⁵⁰⁵ See also Writ, § 377.

to a selection of documents that might be important for the advice on the disputed tax aspects.

864. The unsubstantiated assertion that the tax authorities could not provide relevant advice in a timely manner and in a meaningful way cannot support invocation of a hypothetical *futility* exception – certainly not in this case. After all, if the Tribunal had, from the outset, done what it was legally required to do on the basis of Article 21(5) ECT, it would have had nearly 10 years to request or prepare this advice. Half, or even a quarter, of that time had already been sufficient. As also Sophie Nappert noted, the reasoning of the Tribunal cannot possibly be regarded as an objective basis for such a "*futility*" exception.¹⁵⁰⁶

"[T]he Yukos Tribunals' one-sentence assessment that there existed "no possibility that the relevant authorities would in fact be able to come to some timely and meaningful conclusion about the dispute or make any timely determinations that could potentially serve to assist the Tribunal's decision-making" fails as an objective, reasoned basis for triggering the application of the *futility* exception."

865. The decision of the Tribunal that a referral would have been "*futile*" in the present circumstances, is based solely on its own speculation and its own negligence. Such speculations and failures do not justify a "*futility*" exception.¹⁵⁰⁷
866. The Tribunal has only speculated about the possible content and usability (or desirability) of the conclusions of the tax authorities involved, had they been consulted - in accordance with the mandatory rule of the ECT.¹⁵⁰⁸ This is a clear violation of the prohibition on conjecture in procedural and arbitration law in the Netherlands (as well as other countries): an arbitrator cannot anticipate the evaluation of any evidence or recommendation that has not even been requested yet, let alone provided, but which is nonetheless required for the evaluation.¹⁵⁰⁹ Contrary to what HVY assert¹⁵¹⁰, this prohibition on conjecture – also for

¹⁵⁰⁶ S. Nappert, 'Square Pegs and Round Holes: The Taxation Provision of the Energy Charter Treaty and the Yukos Awards', in: *Cahiers de l'arbitrage*, 1 January 2015, no. 1, p. 9. (**Exhibit RF-209**). Text between brackets added.

¹⁵⁰⁷ SoR, §§ 363-365.

¹⁵⁰⁸ This also confirms the partiality and prejudice of the Tribunal; see chapter V.

¹⁵⁰⁹ See SoR, §§ 341-342.

¹⁵¹⁰ See SoA, § 767.

advice that must be requested, but not necessarily followed – certainly does apply in full in international arbitration.¹⁵¹¹

867. The Tribunal could not predict in advance how the advice of the competent tax authorities, had this been properly asked and given in time, would have read and how it would have valued this advice. In particular, the Tribunal could not know whether its manifest but inadmissible conjecture in respect of the feasibility and quality of the advice that must be requested and considered, would be correct. Finally, also the parties have been deprived of the opportunity to invoke the advice of the tax authorities or otherwise express their views thereon, which is also contrary to the public policy (see chapter VII.C, § 1142).¹⁵¹²

Ad (b): Referral to all competent tax authorities

868. In the second place, the argument that a referral would have been pointless because the Russian tax authorities were "*one of the most important actors in the expropriation of Yukos*"¹⁵¹³, is clearly unfounded. By that logic, referral to the competent tax authorities would *always* be pointless, and should always be avoided as the competent tax authorities of the state in question are, *by definition*, always involved in the tax measure at issue. In addition, this argument cannot possibly justify the refusal to refer the dispute to the other authorities involved, namely the tax authorities of the United Kingdom and Cyprus.¹⁵¹⁴

¹⁵¹¹ See SoR, §§ 344-347, among others quoting Fung Fen Chung, *Bewijsmiddelen in het arbitraal geding*, SDU: The Hague 2004, diss., 170: "*In its opinion the tribunal is in any case not allowed to involve a prognosis of the result of the production of evidence in its opinion. This is a task to be addressed at a later stage. The tribunal can only value the evidence after evidence has been produced.*", and referring to a decision of the Court of Appeal in The Hague 14 October 2004, Prg. 2005, 14 (*Van den Nieuwelaar/Pastou*) in which the Court of Appeal set aside an arbitral award on this basis.

¹⁵¹² The defence of HVY that the Russian Federation's invocation of violation of the principle of hearing both sides in connection with the referral obligation of Article 21(5) ECT is out of time, because the Russian Federation has not advanced this in the Writ, holds no water. After all, the starting point that all setting-aside grounds shall be advanced in the originating Writ subject to forfeiture of rights, is varied from for setting-aside grounds of a public-policy nature. See also P. Sanders, *Het Nederlandse arbitragerecht: nationaal en internationaal*, Deventer: Kluwer 2001, p. 190-191, G.J. Meijer, *T&C Rv*, Article 1064a DCCP, annotation 5(b), H.J. Snijders, *GS Burgerlijke Rechtsvordering*, Article 1064 DCCP, annotation 3. With the finding that no referral to the competent tax authorities has taken place by the Tribunal, it is already an established fact that there is question of a violation of the principle of hearing both sides, and the Russian Federation has therefore fulfilled its burden of proof in this respect (see SoRej., § 260, where HVY argue that the Russian Federation has not fulfilled its burden of proof with regard to the violation of the principle of hearing both sides).

¹⁵¹³ Final Awards, marginal no. 1435; SoD, Part II, § 487.

¹⁵¹⁴ SoR, § 364.

Ad (c): The recommendations must be requested and reviewed

869. In the third place, the violation of Article 21(5) ECT is also not justified by the fact that the conclusions of the competent tax authorities would not be binding for the Tribunal.¹⁵¹⁵ That an arbitral tribunal is not required to follow the content of advice as referred to in Article 21(5) ECT – in so far it concerns an alleged expropriation - does not alter the fact that requesting and examining such advice is mandatory. If Article 21(5)(b) ECT is interpreted in such a way that variance from the obligation to refer a dispute to tax authorities must be accepted solely because the possible conclusions are not binding, this provision is entirely superfluous. Such an interpretation is therefore absurd.¹⁵¹⁶

Ad (d): The Russian Federation repeatedly pointed out the referral obligation; the Tribunal was obliged to make a referral

870. Finally, HVY still argue that it was up to the Russian Federation to submit an opinion of the tax authorities in the Arbitrations, in order to speak for the position of the Russian tax authorities.¹⁵¹⁷ With this argument, HVY wrongly attempt to shift the referral obligation in Article 21(5)(b) ECT to the Russian Federation. Incidentally, the Russian Federation has repeatedly pointed to the mandatory obligation in Article 21(5) and requested the Tribunal to comply with it.¹⁵¹⁸ The text of Article 21(5)(b)(i) ECT is clear on this point: the party arguing that there is question of an expropriation (in this case HVY) shall refer the dispute to the competent tax authorities, and if this party has failed to do so at an earlier stage, then the arbitral tribunal itself must still proceed to this end.¹⁵¹⁹

(f) ***Consequences for crucial parts of the Final Awards***

871. This intentional violation of Article 21(5) ECT has had serious consequences for crucial parts of the Final Awards. None of the arbitrators have any background in tax matters, let alone expertise in matters of Russian tax law. Due to their lack of knowledge of the Russian tax law, they have made various blunders.¹⁵²⁰ For example, the Tribunal ruled that

¹⁵¹⁵ Final Awards, marginal 1427; SoD, Part II, §§ 486, 467.

¹⁵¹⁶ See also Writ § 376 and SoR, § 365.

¹⁵¹⁷ SoA § 766. This is a new defence of HVY compared to the defence in the first instance.

¹⁵¹⁸ See § 853. See footnote 1482.

¹⁵¹⁹ See § 846-847. See also SoR, § 782.

¹⁵²⁰ See Writ, §§ 379-383.

the Yukos VAT assessments were incorrect because the Tribunal itself found it 'difficult to understand' why the requirement of monthly filing (as applies under Russian law for all (!) tax subjects)¹⁵²¹ should be applied to Yukos. Here, the Tribunal based itself on its own opinion of what Russian law *should entail*, and not what Russian law *actually entailed*. Incidentally, this also constitutes - as explained extensively in the case file in the first instance¹⁵²² - a lack of reasoning and is contrary to the public policy.

(g) ***Conclusion: the Tribunal has not complied with its mandate and acted in violation of public order by consciously ignoring Article 21(5) ECT***

872. By failing to obtain the recommendations from the competent tax authorities, which is required, the Tribunal clearly and deliberately violated an express mandatory procedural rule contained in the ECT (Article 21(5) ECT). The Tribunal has with respect to a crucial part of the legal battle, without sound basis - and only on the basis of biased conjecture - refused to request and take into account in its assessment mandatory and relevant advice and evidence. This constitutes serious non-compliance with the mandate and is contrary to the public policy, which should lead to the setting aside of the Yukos Awards (Article 1065(1)(c) and (1)(e) DCCP).

D. Mandate Ground 2 – The Tribunal violated its mandate by not allowing the Russian Federation an opportunity to set out its position on the Tribunal's own method for calculation damages

The Russian Federation refers to:		
<u>Arbitrations:</u>		
Final Awards	Chapter XII	marginal nos. 1693-1829
<u>Setting aside proceedings:</u>		
Writ	Chapter V.D	§§ 386-467
SoD	Part I, Chapter 3.4.3	§§ I.144-167
	Part II, Chapter 3.2	§§ II.491-596
SoR	Chapter IV.D, Annex 1	§§ 367-476
	Chapter VI.C	§§ 645-662
	Chapter VII.D	§ 825
SoRej	Chapter 3.3	§§ 275-349
Pleading Notes RF	Chapter VII	§§ 76-93
Pleading Notes HVY	Chapter 3.1-3.5	§§ 110-146

¹⁵²¹ It has been established that Yukos, when after many years it was still granted the opportunity to submit such a request for the 0 rate and/or an exemption, knowingly failed – such contrary to the mandatory and by all means comprehensible regulations in that respect – to submit any document that could serve as evidence for the actual existence of the transactions in question and the exports thereof. Obviously, there was no such thing as an exemption request in accordance with the mandatory requirements. Each tax expert stated in this respect, without any hesitation, that such a request as submitted by Yukos was absolutely inadequate.

¹⁵²² See Writ, §§ 382, 530, 566-568, and SoR, §§ 719-725, 819-820.

Primary exhibits:Arbitrations:

RF-03.1.C-2.1	First Kaczmarek Report
RF-03.1.C-2.2.1	First Dow Report in the Arbitrations
RF-03.1.C-2.3	Second Kaczmarek Report
RF-03.1.C-2.4.1	Second Dow Report in the Arbitrations
RF-03.1.G-4 Kaczmarek	Kaczmarek Testimony
RF-03.1.G-4 Dow	Dow Testimony

Setting aside proceedings:

RF-85	First Dow Report in the setting-aside proceedings
RF-214	Kathleen Paisley Presentation
HVY-D6	Giles Report
RF-D18	Expert Opinion of prof. Dow 2017
RF-D19	Expert Opinion of Hermes 2017

Essence of the argument

- The determination of the loss was an impermissible surprise decision. This constitutes, among other things, a violation of the mandate (Article 1065 (1) (c) DCCP).
- The decision entailed that the Tribunal applied its own, new, unexpected, unforeseeable and furthermore incorrect method in calculating Yukos' equity value and the lost dividends.
- Different parts of this method had furthermore already been rejected by the Tribunal itself.
- Although HVY do not argue that the Russian Federation could not have anticipated this, they also, contradictory, attempt to give the impression as if all of this was discussed in the Arbitrations, but fail to substantiate this and ignore the Tribunal's decisions to the contrary.
- The Tribunal furthermore violated its mandate by in violation of Article 13 ECT, failing to use the reference date (the date of the expropriation) that is prescribed therein for the valuation of Yukos and using instead the (hypothetical) date of the Final Awards.
- The result of the surprise decision is serious because it leads to, inter alia, a double counting in the loss calculation of at least 40%, or more than USD 20 billion.
- The Tribunal's method is based on inconsistent reasoning and therefore lacks sound reasoning (Article 1065 (1)(d) DCCP).
- At the same time, a failure to hear the parties about the new method constitutes a

violation of the principle of hearing both sides of the argument (Article 1065 (1)(e) DCCP.

(a) *Introduction*

873. The Russian Federation maintains in full the substantiation of the grounds for setting aside regarding the loss calculation it provided in the first instance for these grounds for setting aside, as enshrined in Article 1065(1)(d) and (e) DCCP. In addition, it maintains its previous offers of evidence and its disputations of the defences advanced on these grounds by HVY. For the Court of Appeal's convenience, the Russian Federation will present the essence of its earlier argument in connection with this setting aside ground once again in this chapter, without prejudice to the devolutive effect of the appeal. The Russian Federation will supplement this with the refutation of what HVY advanced in their defence before, in and with their statement of appeal.
874. The argument in this chapter is that the Yukos Awards must be set aside based on Article 1065 (1)(c) DCCP (violation of the mandate, with a surprise decision and an incorrect application of Article 13 ECT). The Tribunal has used its own reference dates and own method.
875. Like in the first instance, the factual and legal substantiation of this violation of the mandate also serves as substantiation of the independent grounds for setting aside of the lack of a (sound) reasoning and a breach of public policy. The plea for these three grounds for setting aside (Article 1065 sub 1 (c), (d) and (e) DCCP) is based on the same factual essence in this case.
876. After all, not only was the method of the Tribunal an inadmissible surprise, it was also based on the methods that had been rejected and placed outside of the legal dispute by the Tribunal in the same Final Awards: the Tribunal expressly rejected the DCF method as being unreliable and also rejected the application of the RTS Oil and Gas Index on Yukos as a whole because HVY advanced it too late. The application of the methods rejected in the same judgment without any comprehensible explanation means that the loss assessment lacks a sound reasoning. Based on Article 1065 (1)(d) DCCP the Yukos Awards must also be set aside.¹⁵²³

¹⁵²³ See also Chapter VI.C.

877. Furthermore, a surprise decision means that the parties were never heard on the matter prior to the decision, which should have happened. This is certainly true for this case, where the Tribunal made serious mistakes because it failed to hear the parties. Would this 'hearing' indeed have appropriately taken place, then the Russian Federation could have saved the Tribunal – and therewith itself – for serious consequences of the challenged surprise and inconsistency. The principle of hearing both sides of the argument has therefore wrongly not been applied. This is a violation of a fundamental procedural principle and therewith a violation of the public policy. The Awards must also be set aside pursuant to Article 1065(1)(e) DCCP.¹⁵²⁴
878. Instead of returning to the parties to propose the reference dates devised by the Tribunal itself – i.e. 19 December 2004 and 30 June 2014 – and ask for the necessary entry of missing data by their experts, the Tribunal applied its own method to nevertheless determine the value of Yukos on those dates (by using the RTS Oil & Gas Index, which had not been applied in this way and under those circumstances before) and to calculate the lost dividends (by using the DCF method, what was at odds with the RTS Oil & Gas Index used for the equity value and the Tribunal's own calculation for the period 2012-2014, which had not been discussed). Neither, this methodology was presented to the parties. This is a textbook example of a surprise decision, which constitutes a serious violation of the mandate. Accordingly, the setting aside pursuant to Article 1065 (1)(c) DCCP is required.
879. Moreover, the use of the hypothetical date of the Final Awards as a reference date is contrary to Article 13 ECT, which mentions only one date as the reference date for the loss, to wit the date immediately preceding the actual expropriation. This also constitutes a violation of the mandate and also an inadmissible surprise decision which the Russian Federation was not able to anticipate, which is another reason why the Yukos Awards must be set aside on the basis of Article 1065(c) DCCP.
880. In what follows, the Russian Federation will once again demonstrate:¹⁵²⁵

¹⁵²⁴ See also Chapter VII.C.

¹⁵²⁵ See also Writ, chapter V.D and SoR, chapter IV.D, and Annex 1.

- (a) that the Tribunal's valuation dates of 19 December 2004 and 30 June 2014 were never proposed by the parties, as a result of which no valuations were available for those dates;¹⁵²⁶
- (b) that the Tribunal's use of the RTS Oil & Gas Index to transpose Yukos' equity value on 21 November 2007 (for which date the arbitration file did contain a loss calculation by HVY)¹⁵²⁷ to 2004 and to 2014 was not part of the debate between the parties;¹⁵²⁸
- (c) that the alleged lost dividend was calculated in a manner not apparent from the debate between the parties;¹⁵²⁹

each of them inadmissible surprise decisions, and

- (d) that the valuation dates chosen in the Tribunal's method were contrary to the mandatory rule of Article 13 ECT;¹⁵³⁰ and
- (e) that the Tribunal's use of its own, new method of loss calculation, without hearing the parties, had substantial consequences, especially since the Tribunal did not take into account the inextricable link between dividend and equity value, as a result of which it awarded at least USD 20 billion worth of alleged lost dividend too much in damages.¹⁵³¹

881. Below, the Russian Federation will also refute the arguments raised in this connection by HVY in the Statement of Appeal.

882. With the Writ the Russian Federation submitted already the Expert Opinion of Professor Dow 2014, in which Professor Dow explained that the Tribunal had used a methodology of its own. During the whole of the first instance HVY did not produce a reply in the form of an expert opinion. Only with the Statement of Appeal HVY submitted an expert opinion, the Expert Opinion of Mr. Giles, which opinion however only deals with the argument of the double counting of the alleged lost dividends.¹⁵³²

¹⁵²⁶ See §§ 887-888 on this.

¹⁵²⁷ This damage calculation was nevertheless contested by Professor Dow, the Russian Federation's damages expert, as will be explained below.

¹⁵²⁸ See §§ 907-921 on this.

¹⁵²⁹ See §§ 924-928 on this.

¹⁵³⁰ See §§ 930-934 on this.

¹⁵³¹ See §§ 935-964.

¹⁵³² Exhibit HVY-D6.

883. With the Statement of Defence the Russian Federation submits an expert opinion of the Dutch damage experts Mr. Van Prooijen en Mrs. Toxopeus of the firm Hermes Advisory B.V. ("Expert Opinion of Hermes 2017")¹⁵³³, what again explains that the Tribunal has used a methodology of its own, which had not been proposed or discussed by either party and on which the Russian Federation at that time self-evidently could not have anticipated. In the Expert Opinion of Hermes 2017 it is concluded as follows:

"In our opinion, the Tribunal, in the Final Awards, applied reference dates that were not discussed and used its own methodology to establish the amount of the damages for HVY, which deviated from the methods that had been proposed by the Parties and that had been discussed during the proceedings. In our opinion, the Parties could not have expected that the Tribunal would apply this methodology, the Parties were not given the opportunity to respond to this methodology and the use of this methodology by the Tribunal has led to serious errors in the calculation. As a result, more than 20 billion dollar compensation has been awarded twice."¹⁵³⁴

884. Further, the Russian Federation submits a new opinion of Professor Dow ("Expert Opinion of Prof. Dow 2017")¹⁵³⁵ Professor Dow, after the study of the Expert Opinion of Mr. Giles, arrives at the same conclusion as the Expert Opinion of Hermes and confirms his earlier findings as laid down in his Expert Opinion of Dow 2014. He concludes as follows:

"In my report of 8 November 2014 I explained that the Tribunal developed its own method to value Yukos, which departed in significant respects from the method proposed and discussed by the parties. Neither I nor HVY's expert had the opportunity to comment on the Tribunal's damages method. This new method was both novel and incorrect – so it was not possible to foresee that the Tribunal might use it. I understand that the foregoing forms the basis of the Russian Federation's "due process" grounds for seeking an Annulment. The Giles Report does not address this issue.

I also explained that the Tribunal's damages method erroneously double counted cash flows – once as equity appreciation and then again as dividends – in the amount of over \$20 billion. The Giles Report disagrees, and is focused exclusively on this issue.

¹⁵³³ Expert Opinion of Hermes 2017 (Exhibit RF-D19).

¹⁵³⁴ Expert Opinion of Hermes 2017, § 22 (Exhibit RF-D19).

¹⁵³⁵ Expert Opinion of Hermes 2017 (Exhibit RF-D18).

The Giles Report advances five principal arguments, each of which are flawed for reasons summarized below, and explained in detail in the body of this report. (...)".¹⁵³⁶

885. As well as in the Expert Opinion of Hermes as in the Expert Opinion of Professor Dow the arguments of the Expert Opinion of Mr. Giles, as submitted by HVY, in connection with the calculation of the alleged lost dividends, are refuted.¹⁵³⁷

(b) *The debate between the parties and the Tribunal's conclusions*

886. The damages awarded to HVY by the Tribunal consist of (a) lost equity value and (b) lost dividends, plus interest.¹⁵³⁸

887. The reference date is one of the most critical elements in any valuation. The Tribunal ruled that there were two important reference dates for the valuation and that the damages would be based on the date that resulted in the highest damages. In the Arbitrations, HVY primarily proposed 21 November 2007 as a reference date, being the date on which Yukos was removed from the register of companies and ceased to exist. It should be noted that HVY considered the possibility that the Tribunal would arrive at a different reference date than the one proposed by them and had therefore offered on more than one occasion to provide new valuations for those dates in that event:

“Moreover, for comparison purposes, Navigant has also carried out a valuation of the Claimants’ damages as at current date. For the purposes of its Second Expert Report, Navigant used the date of December 31, 2011. (...) This valuation date can be subsequently updated to assess the Claimants’ damages at a date closer to the hearing or the Award.”¹⁵³⁹

“Therefore, in addition to our valuation calculations based on an ex-ante approach as of 21 November 2007, we have been asked to conduct an ex-post approach as of 1 January 2012 (a recent date convenient for the preparation of this report).(…) These damages calculations can subsequently be updated, if need be, at a date closer to the hearing or the Award.”¹⁵⁴⁰

¹⁵³⁶ Expert Opinion of prof. Dow 2017, §§ 4-6 (**Exhibit RF-D18**).

¹⁵³⁷ Expert Opinion of Hermes 2017, §§ 28, 29 and § 6.3.4 (**Exhibit RF-D19**) and Expert Opinion of prof. Dow 2017, (**Exhibit RF-D18**) (in full addressing the Expert Opinion of Mr. Giles 2017).

¹⁵³⁸ See a.o. Final Awards, marginal 1778.

¹⁵³⁹ Claimants’ SoR on the Merits, § 946 (**Exhibit RF-03.1.B-4**) (emphasis added)

¹⁵⁴⁰ Second Kaczmarek Report, § 155 (**Exhibit RF-03.1.C-2.3**) (emphasis added).

“For practical purposes, Navigant has assessed the Claimants’ damages as of January 1, 2012, shortly before the submission of its Second Expert Report. These calculations can subsequently be updated at a date closer to the award, if need be.”¹⁵⁴¹

888. However, the Tribunal completely disregarded this and ruled that 19 December 2004 (the date immediately preceding the alleged expropriation on account of the auction of YNG) and 30 June 2014 (the hypothetical date of the Final Awards) were the two relevant reference dates. However, these dates appeared out of thin air. They had never been proposed by the parties or earlier by the Tribunal itself. Thus, no data and analyses were available for the Tribunal to calculate the loss on those dates.¹⁵⁴²
889. It follows from this that HVY’s assertions that “*the Tribunal based its loss assessment exclusively on information in the case file (...)*”¹⁵⁴³ and that everything “*falls entirely within the debate between the parties*”¹⁵⁴⁴ do not hold. Nor, as suggested by HVY, does the Russian Federation submit new data in this setting aside proceedings, for which reason this reproach cannot be successful either.¹⁵⁴⁵
890. During the Arbitrations, Mr Kaczmarek, HVY’s damages expert, proposed several methods, scenarios and calculations to establish the extent of the damage¹⁵⁴⁶, starting primarily from 21 November 2007.
891. Mr Kaczmarek had through three methods calculated the equity value of Yukos:
- (a) Discounted Cashflow or DCF method¹⁵⁴⁷
 - (b) Comparable companies method¹⁵⁴⁸

¹⁵⁴¹ Claimants’ Post-Hearing Brief, § 233, footnote 499 (**Exhibit RF-03.1.B-6**) (emphasis added).

¹⁵⁴² Expert Opinion of Hermes 2017, §§ 25, 70-77 and § 6.3.4 (**Exhibit RF-D19**) and Expert Opinion of prof. Dow 2017, §§ 16-19 (**Exhibit RF-D18**).

¹⁵⁴³ SoA, § 775.

¹⁵⁴⁴ SoA, § 776.

¹⁵⁴⁵ SoA, § 720.

¹⁵⁴⁶ First Kaczmarek Report (**Exhibit RF-03.1.C-2.1**); Second Kaczmarek Report (**Exhibit RF-03.1.C-2.3**); Final Awards, marginal no. 1762.

¹⁵⁴⁷ In the DCF method, the equity value of a business is calculated by working back the cash flows generated by that business in the future into the cash flows generated on the reference date, using a discount factor that takes into account both the passage of time and the risk profile of the business.

¹⁵⁴⁸ In the comparable companies method, companies are identified that are comparable to the business to be valued. The relevant parameters of those comparable businesses (such as turnover, profit, possessions) are

(c) Comparable transactions method¹⁵⁴⁹

Because none of these methods were sufficiently reliable in and of themselves, according to Mr Kaczmarek, he proposed a weighted average of the three of them of 50%, 40% and 10%, respectively.¹⁵⁵⁰ He literally stated:

“To arrive at a final valuation conclusion of the share capital of Yukos as of 21 November 2007, we weight the results of our three valuation approaches in accordance with the strength and confidence we have in each approach.”¹⁵⁵¹

892. Professor Dow, the Russian Federation’s damages expert, commented on these calculations, whereby Professor Dow demonstrated that Mr Kaczmarek’s submissions displayed numerous serious defects, inaccuracies and inconsistencies.¹⁵⁵²

893. The Tribunal agreed with Professor Dow’s criticism of Mr Kaczmarek’s calculations on several parts. The Tribunal accordingly ruled that two of the three methods proposed by Mr Kaczmarek to calculate the equity value, to wit both the DCF method and the comparable transactions method, were not “*sufficiently reliable to ground a determination of damages for this case.*”¹⁵⁵³

894. This ruling was based on, among other things, the fact that it had become clear that Mr Kaczmarek had reasoned towards the desired result in his DCF analysis:

“On balance, the Tribunal was persuaded by Professor Dow’s analysis of Claimants’ DCF model, and is compelled to agree that little weight should be given to it. The Tribunal observes that Claimants’ expert admitted at the Hearing that his DCF analysis had been influenced by his own pre-determined notions as to what would be an appropriate result.”¹⁵⁵⁴

then compared against their equity value, from which multiples are derived. These multiples are then applied to the parameters of the business to be valued to calculate the equity value in that way.

¹⁵⁴⁹ In the comparable transactions method, transactions are identified that involve the sale of an interest in businesses that are comparable to the business to be valued. The relevant parameters of those comparable businesses (such as turnover, profit, possessions) are then compared with the purchase price, from which multiples are derived. These multiples are then applied to the parameters of the business to be valued to calculate the equity value in that way.

¹⁵⁵⁰ First Kaczmarek Report § 436 (**Exhibit RF-03.1.C-2.1**).

¹⁵⁵¹ First Kaczmarek Report § 436 (**Productie RF-03.1.C-2.1**).

¹⁵⁵² First Dow Report (**Exhibit RF-03.1.C-2.2.1**); Second Dow Report (**Exhibit RF-03.1.C-2.4.1**).

¹⁵⁵³ Final Awards, marginal no. 1785.

¹⁵⁵⁴ Final Awards, marginal no. 1785, with reference to Transcript Hearing on the Merits, Day 11, 190 (**Exhibit RF-03.1.G-4**).

895. Mr Kaczmarek’s comparable transactions model was also rejected by the Tribunal, since “both Parties agree that, in fact, there were no comparable transactions, and thus no basis that would allow a useful comparison”¹⁵⁵⁵ – there were no comparable transactions.

896. The Tribunal ruled with regard to Mr Kaczmarek’s calculations of the dividends, for which he also applied his DCF model, that these results also stemmed from Mr Kaczmarek’s bias:

“(…) the Tribunal is unable to dissociate them from Claimants’ DCF model, which was convincingly criticized by Respondent’s expert and its counsel.”
1556

897. As such, the majority of the methods, scenarios and calculations proposed by HVY were rejected in their entirety by the Tribunal.¹⁵⁵⁷ The Tribunal did not have the DCF method or the comparable transactions method available to it. Consequently, the Tribunal could only start from the comparable companies method, which – incidentally – already deviated from the debate between the parties as Mr Kaczmarek had never proposed this method as a sufficiently reliable method in and of itself.¹⁵⁵⁸

898. The Tribunal subsequently constructed its own, new method of loss calculation, without hearing the parties in this regard. The first defense HVY assert against this reproach of the Russian Federation – that the Russian Federation had “*ample opportunity to respond to HVY’s arguments*”¹⁵⁵⁹ in the Arbitrations with respect to the determination of the damages – completely disregards the Russian Federation’s argument.

899. In the end, the question is not whether the Russian Federation was able to respond to HVY in the Arbitrations. The argument is that the Russian Federation was unable to respond to the – without any basis in the statements of HVY at the time – self-devised method of the Tribunal. Indeed, this method was presented to the parties only in the Final Awards. Naturally, the Russian Federation was unable to express its opinion on that and could not anticipate it either.

¹⁵⁵⁵ Final Awards, marginal no. 1785, with reference to Claimants’ Memorial on the Merits, § 945 (**Exhibit RF-03.1.B-1**); Respondent’s Post-Hearing Brief, § 242 (**Exhibit RF-03.1.B-6**).

¹⁵⁵⁶ Final Awards, marginal no. 1799.

¹⁵⁵⁷ See also the Final Awards, marginal no. 1878: “*By contrast to all of the other methods canvassed above, the Tribunal does have a measure of confidence in the comparable companies method as a means of determining Yukos’ value.*” (emphasis added).

¹⁵⁵⁸ See Expert Opinion of Hermes 2017, §§ 42-46 (**Exhibit RF-D19**).

¹⁵⁵⁹ SoA, § 774.

900. HVY's assertion that "*the Russian Federation, although invited to do so by the Tribunal, did not itself perform an alternative loss calculation (...)*"¹⁵⁶⁰ also lacks any ground, as the Russian Federation already explained in the first instance that it certainly did propose multiple alternative loss calculations.¹⁵⁶¹ That aside, this reproach also disregards the key issue. The fact is that a tribunal is not free to make up its own method outside of the debate between the parties and without submitting it first to the parties to ensure they are heard.

(c) ***The Tribunal's own methodology***

901. The Tribunal's own methodology concerns the calculation of both the equity value and the lost dividends. The Tribunal acknowledges that there is an own methodology at hand by stating "Having explained the Tribunal's methodology".¹⁵⁶²

(c)(i) *Calculation of equity value by the Tribunal*

902. Mr Kaczmarek proposed to use a combination of three models to calculate the equity value: the DCF method, the comparable transactions method and the comparable companies method. As explained above, the Tribunal rejected two of the three methods.¹⁵⁶³ The Tribunal chose to use parts of the comparable companies method by selective cutting and pasting. But Professor Dow had demonstrated also that even Mr Kaczmarek's analysis based on this part of Kaczmarek's damages calculation showed many defects, inaccuracies and inconsistencies.¹⁵⁶⁴

903. However, the Tribunal ruled nevertheless that it could use the comparable companies method for the equity value valuation as if it were a result pleaded by the parties. It did so by considering the results of Professor Dow's analysis as an independent valuation in which Mr Kaczmarek's defects, inaccuracies and inconsistencies had been "corrected". The Tribunal wrongly made it appear as if Professor Dow had asserted during the hearing that the results of his analysis "*could be a useful valuation*".¹⁵⁶⁵

¹⁵⁶⁰ SoA, § 774.

¹⁵⁶¹ See SoR, Annex 1, §§ 25-27.

¹⁵⁶² Final Awards, marginal no. 1790.

¹⁵⁶³ See §§ 891-896.

¹⁵⁶⁴ See also Second Dow Report, § 394 et seq. (**Exhibit RF-03.1.C-2.4.1**).

¹⁵⁶⁵ Final Awards, marginal no. 1787, with reference to Transcript Hearing on the Merits, Day 12, 47 (**Exhibit RF-03.1.G-4**). In marginal no. 1789, the Tribunal therefore starts from the valuation of Yukos (USD 61.076 billion) that it established in marginal 1783 on the basis of Professor Dow's comments.

904. However, that is an incomplete representation of Professor Dow's statement. Indeed, Professor Dow explained at the hearing – as he did in his report¹⁵⁶⁶ – that he in no way endorses the figures as a useful independent valuation:

“So I haven't done enough analysis on these to endorse them in that sense, and I don't think it would be responsible of me to endorse them for a purpose that they weren't reported in that figure as being useful for.”¹⁵⁶⁷

905. Therefore, the Tribunal wrongly based its calculation of Yukos's equity value as on 21 November 2007 on the results of Professor Dow's analysis and made it appear as though it thereby arrived at a valuation endorsed by the parties.¹⁵⁶⁸

906. In the end, moreover, as explained above,¹⁵⁶⁹ the Tribunal did not use the date proposed by HVY – 21 November 2007 – as reference date, but ruled that the relevant dates were 19 December 2004 and 30 June 2014 – dates that had never been proposed by any party.¹⁵⁷⁰ As the record contained no valuations with regard to those dates, the Tribunal decided to use its own method, without, however, hearing the parties in this respect.¹⁵⁷¹

907. To determine the equity value, the Tribunal started from the value of Yukos as at 21 November 2007 according to Mr Kaczmarek's calculation, which was adjusted by the Tribunal by applying Professor Dow's 'corrections'.¹⁵⁷²

908. The Tribunal then decided to carry the 'corrected' valuation back and forward to the expropriation date (19 December 2004) and hypothetical award date (30 June 2014) chosen by the Tribunal.

¹⁵⁶⁶ Second Dow Report (**Exhibit RF-03.1.C-2.4.1**), § 7.

¹⁵⁶⁷ Transcript Hearing on the Merits, Day 12, 48:12-16 (**Exhibit RF-03.1.G-4**).

¹⁵⁶⁸ HVY follow the Tribunal in the inaccurate presentation of professor Dow's position and argue that it thus cannot be a surprise decision that the Comparable Companies method was applied (SoA, §299). This defense needs to fail.

¹⁵⁶⁹ See § 887 et seq.

¹⁵⁷⁰ See Expert Opinion of Hermes 2017 (**Exhibit RF-D19**), §§ 49-51.

HVY rightly so does not dispute that 19 December 2004 and 30 June 2014 had never been proposed as factual data. HVY only argue that a valuation per date of the final awards had been discussed (SoA, § 305). This may be the case, but the actual date of 30 June 2014 had not been discussed and as a consequence the Tribunal started to tinker on its own to arrive at the equity value at that final awards date without hearing the parties about that.

¹⁵⁷¹ See also Expert Opinion of Hermes 2017 (**Exhibit RF-D19**), §§ 25, 70-88, and Expert Opinion of prof. Dow 2017 (**Exhibit RF-D18**), §§ 16-19.

¹⁵⁷² Final Awards, marginal nos. 1782-1783.

909. The Tribunal did so by assuming that the ‘corrected’ equity value of Yukos as at 21 November 2007 would follow the so-called RTS Oil & Gas Index – a share index for Russian oil and gas companies.¹⁵⁷³ Based on the course of this index between 21 November 2007 and, respectively, 19 December 2004 and 30 June 2014, the Tribunal then determined the equity value on each of those dates.¹⁵⁷⁴

910. In doing so, the Tribunal made it appear as though this method was also used and endorsed by the parties:

“Both Parties have referred to the RTS Oil & Gas index as a reliable indicator reflecting the changes in the value of Russian oil and gas companies and have used it in their calculations to carry forward certain valuations from one date to another.”¹⁵⁷⁵

This statement is incorrect.¹⁵⁷⁶

911. First, the Tribunal misrepresents the facts with its comment that “*Both Parties have referred to the RTS Oil & Gas index as a reliable indicator reflecting the changes in the value of Russian oil and gas companies (...)*”. During the hearing, Professor Dow was asked whether he considered the RTS Oil & Gas Index a “*reliable index*”.¹⁵⁷⁷ Professor Dow replied as follows:

“Well, by definition it’s a reliable index of Russian share companies’ changes, because it is built up of Russian share companies’ price changes.”¹⁵⁷⁸

912. In saying so, Professor Dow in no way endorsed the Tribunal’s subsequent use of the Index, which he could not have known at the time of the hearing, but merely confirmed that this Index provides an overview of the course of Russian oil and gas company share prices.¹⁵⁷⁹

¹⁵⁷³ Final Awards, marginal no. 1788.

¹⁵⁷⁴ Final Awards, marginal nos. 1789, 1815-1816, 1821-1822.

¹⁵⁷⁵ Final Awards, marginal no. 1788 (footnotes removed).

¹⁵⁷⁶ See also Hermes' 2017 Expert Opinion (**Exhibit RF-D19**), §§ 26, 83-88, and Prof. Dow's 2017 Expert Opinion (**Exhibit RF-D18**), §§ 20-23.

¹⁵⁷⁷ Transcript Hearing on the Merits, Day 12, 67:24 (**Exhibit RF-03.1.G-4**).

¹⁵⁷⁸ Transcript Hearing on the Merits, Day 12, 67:25-68:2 (**Exhibit RF-03.1.G-4**).

¹⁵⁷⁹ SoRej., § 307 provides the same unjust presentation of facts and that defence needs to be rejected.

UNOFFICIAL TRANSLATION

This text is an unofficial translation of the Dutch original. In case of any discrepancies, the Dutch original shall prevail.

913. Second, the Tribunal also wrongly makes it appear as though the Tribunal's use was endorsed by the parties with its comment that "*Both parties (...) have used it in their calculations to carry forward certain valuations from one date to another.*"¹⁵⁸⁰ That is not the case.

914. Mr Kaczmarek used the RTS Oil & Gas Index a number of times during the Arbitrations to carry the value of specific Yukos assets across a limited period.¹⁵⁸¹ Professor Dow also used the RTS Oil & Gas Index in his analysis of Kaczmarek's valuation, but only to demonstrate the deficiencies of a number of Kaczmarek's valuations and not – as the Tribunal did – to calculate the asset value fluctuations of Yukos across a much longer period, which is clearly inappropriate.¹⁵⁸²

915. Professor Dow therefore explicitly indicated during the hearing that he merely used a method proposed by Mr Kaczmarek and did not comment on its validity:

"Yes, I am using Mr Kaczmarek's methodology; correct."¹⁵⁸³

"(...) Mr Kaczmarek carries that forward in time, using the method you just referred to, (...)"¹⁵⁸⁴

"(...) to carry forward the argument, I use the same extrapolation for the purposes of the exercise, the same bringing forward in time that he himself used there. I don't go into the question of whether that's the best possible way to bring things forward in time (...)"¹⁵⁸⁵

916. More critically, while Mr Kaczmarek used the RTS Oil & Gas Index only to carry the value of specific Yukos assets across a limited period (approximately 16 months),¹⁵⁸⁶ the Tribunal used the RTS Oil & Gas Index to adjust the value of Yukos as a whole across a total period of almost ten years. Such a use was never suggested by the parties, let alone endorsed.¹⁵⁸⁷

¹⁵⁸⁰ Final Awards, marginal no. 1788 (footnotes removed).

¹⁵⁸¹ See Final Awards, marginal no. 1788, footnote 2383.

¹⁵⁸² *Idem*.

¹⁵⁸³ Transcript Hearing on the Merits, Day 12, 68:10 (**Exhibit RF-03.1.G-4**).

¹⁵⁸⁴ Transcript Hearing on the Merits, Day 12, 69:5 (**Exhibit RF-03.1.G-4**).

¹⁵⁸⁵ Transcript Hearing on the Merits, Day 12, 69:15-19 (**Exhibit RF-03.1.G-4**).

¹⁵⁸⁶ See further in SoR, § 390.

¹⁵⁸⁷ Also see Hermes' 2017 Expert Opinion (**Exhibit RF-D19**), §§ 83-88.

917. The parties also could not reasonably be expected to account for the possibility that the Tribunal would calculate the value of Yukos in this manner. After all, HVY submitted a number of new valuations toward the end of the Arbitrations.¹⁵⁸⁸ One of these was – for the first time – based on carrying the equity value of Yukos as a whole across time using the RTS Oil & Gas Index.¹⁵⁸⁹
918. HVY emphasised that these valuations were based on alternative methods compared to the valuations provided earlier.¹⁵⁹⁰ Through these “*reasonable checks*”, HVY attempted to demonstrate that the earlier valuations provided by Mr Kaczmarek were reasonable, because the alternative methods produced similar results:

“All of these reasonableness checks based on objective, historical data provide confidence in Navigant’s [Kaczmarek, added by counsel] valuation results.”¹⁵⁹¹

919. However, the Tribunal rejected these proposed new valuations for being late, because the Russian Federation did not have sufficient opportunity to respond to them:

“Moreover, some of these figures [including the relevant use of the RTS Oil & Gas Index, added by counsel] were only introduced by Claimants at a very late stage of the proceedings (through demonstrative exhibits at the Hearing and in Claimants’ Post-Hearing Brief) and could therefore not be properly addressed by Respondent.”¹⁵⁹²

920. In keeping with this, the Tribunal ruled that none of these methods could be used to establish the value of Yukos:

“Accordingly, the Tribunal finds that none of these secondary valuation methods [including the relevant use of the RTS Oil & Gas Index, added by

Such is acknowledged by HVY. In the SoRej., § 308, they indeed argue that “*If this share index is suitable to calculate value developments of shares in subsidiaries of Yukos, the same must apply to the value development of the shares in Yukos.*” (emphasis in the original left out). From this it follows that it was not discussed between the parties. By the way, the Tribunal itself did not use such reasoning.

¹⁵⁸⁸ (C-1783), (C-1784), (C-1785) – see Transcript Hearing on the Merits, Day 17, 247:4 et seq. (**Exhibit RF-03.1.G-4**); Claimants’ Post-Hearing Brief, §§ 260-262, footnote 535 (**Exhibit RF-03.1.B-6**).

¹⁵⁸⁹ (C-1784).

¹⁵⁹⁰ (C-1783), (C-1784), (C-1785) - see Transcript Hearing on the Merits, Day 17, 247:4 et seq. (**Exhibit RF-03.1.G-4**); Claimants’ Post-Hearing Brief, §§ 260-262, footnote 535 (**Exhibit RF-03.1.B-6**).

¹⁵⁹¹ Claimants’ Post-Hearing Brief, § 264 (**Exhibit RF-03.1.B-6**). Kaczmarek was employed by Navigant.

¹⁵⁹² Final Awards, marginal no. 1786 (footnotes removed) (emphasis added).

counsel] can serve as a suitable independent basis for determining the value of Yukos.”¹⁵⁹³

921. Contrary to how the Tribunal made it appear, the use of the RTS Oil & Gas Index to determine the equity value of Yukos as a whole during a decennium was not part of the debate between the parties, nor was this method endorsed by both parties. This is already clear from the fact that the Tribunal even rejected this exact use of the RTS Oil & Gas Index because it was submitted too late. HVY’s assertion that “*in the loss assessment, the Tribunal relied exclusively on information that originated from the case file in the Arbitrations and on the valuation methods used by parties*”¹⁵⁹⁴ is therefore also disproved on this point.¹⁵⁹⁵
922. In conclusion, the Tribunal decided beyond the debate between the parties and, in doing so, violated its mandate in calculating the equity value:
- (a) It used the comparable companies method as an independent method, while Mr Kaczmarek had presented this method only in the context of a combination of methods, whereby he acknowledged that the individual methods were not reliable if used alone.¹⁵⁹⁶
 - (b) To justify this, as well as of the fact that the Tribunal started from Mr Kaczmarek’s valuation convincingly criticised by Professor Dow, the Tribunal wrongly made it seem as if it arrived at a valuation endorsed by Professor Dow by applying the ‘corrections’ he had proposed. Professor Dow, however, had emphasised that this was not true.¹⁵⁹⁷
 - (c) The Tribunal subsequently applied the RTS Oil & Gas Index to carry the equity value of Yukos as a whole from 2007 back to 2004 and forward from 2007 to 2014. This 10 year use of the RTS Oil & Gas Index was not part of

¹⁵⁹³ Final Awards, marginal no. 1786 (footnotes removed).

¹⁵⁹⁴ SoA, § 775.

¹⁵⁹⁵ The argument of HVY (SoRej., §§ 310-314) that the Tribunal would not have rejected the RTS-index in the rejection of those secondary methods that were submitted too late, is untenable. They surpass in their fabricated reading of what the Tribunal stated the last clear sentence of the Tribunal “*Accordingly, the Tribunal finds that none of these secondary valuation methods can serve as a suitable independent basis for determining the value of Yukos.*” See Hermes’ 2017 Expert Opinion (**Exhibit RF-D19**), § 40, method 6 in the Table.

¹⁵⁹⁶ Hermes’ 2017 Expert Opinion (**Exhibit RF-D19**), § 82.

¹⁵⁹⁷ Hermes’ 2017 Expert Opinion (**Exhibit RF- D19**), § 80.

the debate between the parties, or had at least not been advocated by HVY in good time, for which reason it was rejected by the Tribunal.¹⁵⁹⁸

- (d) Thus, the final result comprised three steps, none of which were part of the debate between the parties.¹⁵⁹⁹

923. When the Tribunal came to the conclusion that the file contained insufficient information to calculate the loss on the dates determined by the Tribunal (for which the Tribunal should already have reverted to the parties), it should also have asked the parties for input on the loss calculation per those dates and by the Tribunal's suggested method. By not doing so, the Tribunal violated the Russian Federation's right to be heard and rendered a surprise decision, as the Russian Federation could not and should not have foreseen that the Tribunal would choose this course.¹⁶⁰⁰ This is a serious violation of the mandate and also a violation of public policy.

(c)(ii) Calculation of dividend by the Tribunal

924. Because the Tribunal rejected the DCF method (also for the dividend flows calculated therein), precisely because Mr Kaczmarek was predisposed towards a result with regard to the dividend calculation as well,¹⁶⁰¹ the file simply no longer contained a dividend calculation. The Tribunal nevertheless decided – without returning to the parties – to calculate the alleged lost dividends using data from the DCF calculations by Mr Kaczmarek that the Tribunal itself had rejected.¹⁶⁰² The Tribunal did not even attempt to explain this U-turn. By following a course all of its own, the Tribunal made serious errors in using the DCF method, precisely because the separate use of dividend data in the DCF method had not been argued by the parties and because the DCF method takes into account the interaction between the equity value and the dividend distribution in an integrated way¹⁶⁰³. This will be explained in more detail below.¹⁶⁰⁴ Also with the calculation of

¹⁵⁹⁸ Hermes' 2017 Expert Opinion (**Exhibit RF- D19**), §§ 83-87.

¹⁵⁹⁹ Hermes' 2017 Expert Opinion (**Exhibit RF- D19**), §§ 116-120, 124-130.

¹⁶⁰⁰ Second Dow Report (**Exhibit RF-03.1.C-2.4.1**), § 8; Hermes' 2017 Expert Opinion (**Exhibit RF- D19**), §§ 87-88.

¹⁶⁰¹ See § 894, with reference to Final Awards, marginal no. 1799.

¹⁶⁰² See Hermes' 2017 Expert Opinion (**Exhibit RF-D19**), §§ 89-95.

¹⁶⁰³ HVY submitted the Giles Report with the SoA, in which Giles denies such a connection. That such is against his better judgment and that the academic writings Giles state to rely upon are irrelevant or have in the meantime been refuted, is shown in the Expert Opinion of prof. Dow 2017 (in particular Chapters VI-XII and Appendix I).

dividends the Tribunal speaks of an own method: "*According to the Tribunal's methodology*".¹⁶⁰⁵

925. The dividend calculations that followed Mr Kaczmarek's DCF model were analysed and criticised by Professor Dow in the Arbitrations.¹⁶⁰⁶ Moreover, Professor Dow demonstrated that these contain not only significant errors and inconsistencies, but that Mr Kaczmarek also deliberately calculated towards a desired result. The Tribunal agreed with Professor Dow on this, as demonstrated above.¹⁶⁰⁷

926. With respect to the dividend calculation in the DCF method, too, Professor Dow explicitly indicated that his analysis did not result in a valuation that he could endorse:

"The Second Kaczmarek Report, and Claimants in their Reply, appear to have misunderstood my comments as somehow intended to reflect my agreement with his model. In this, Claimants and Mr. Kaczmarek are mistaken. Mr. Kaczmarek's valuation of Yukos is so rife with errors, unsupported assumptions, and potential reverse engineering as to render it totally unreliable."¹⁶⁰⁸

"Modifying Mr. Kaczmarek's analysis as I have suggested above results in a valuation for Yukos that is US\$ 48.8 billion, or 51%, lower than what Mr. Kaczmarek concludes – US\$ 46.5 billion, as opposed to Mr. Kaczmarek's US\$ 95.3 billion. (...) For the avoidance of doubt, however, I do not conclude that on 21 November 2007 (or on any other date) Yukos was properly valued at US\$ 46.5 billion. As discussed above, and at further length below, even that number is artificially inflated by Mr. Kaczmarek's selective and unsupported assumptions, many of which cannot be 'corrected' in the way that the mathematical errors above can be. The purpose of the foregoing analysis is to demonstrate the arbitrariness of Mr. Kaczmarek's model."¹⁶⁰⁹

927. But again, the Tribunal ignored this proviso. Despite the fact that the Tribunal rejected Mr Kaczmarek's DCF model in its entirety, the Tribunal did not consider it problematic to use the results of this model as the basis for its own dividend calculations. The Tribunal attempted to justify this by copying Professor Dow's comments and then wrongly making it appear as though it had arrived at a valuation endorsed by the parties:

¹⁶⁰⁴ See §§ 935 et seq.

¹⁶⁰⁵ Final Awards, marginal no. 1817.

¹⁶⁰⁶ Second Dow Report, chapter 4.2 – see §§ 240, 316-317 in particular (**Exhibit RF-03.1.C-2.4.1**).

¹⁶⁰⁷ See § 896, with reference to Final Awards, marginal 1799.

¹⁶⁰⁸ Second Dow Report (**Exhibit RF-03.1.C-2.4.1**), § 240.

¹⁶⁰⁹ Second Dow Report (**Exhibit RF-03.1.C-2.4.1**), §§ 315 - 316.

“While Respondent’s expert has not explicitly endorsed this ‘corrected’ version as representing his views with regard to Yukos’ free cash flow to equity, it is evident to the Tribunal that it represents a figure that is more in line with his views.”¹⁶¹⁰

928. This is incorrect. Not only did Professor Dow never endorse the figures, he explicitly indicated that he could not endorse the figures as an independent valuation, as set out in the previous section. As explained above,¹⁶¹¹ the Tribunal had explicitly rejected the DCF method, precisely because of Professor Dow’s valid comments and Mr Kaczmarek’s acknowledgement that he had indeed reasoned towards a result. This is apart from a serious violation of the mandate, also a complete lack of conclusive reasoning.
929. In conclusion, also the Tribunal’s dividend calculation went complete beyond the debate between the parties. To account for this, the Tribunal distorted Professor Dow’s statements and disregarded the earlier rejection of the basis of the DCF method. It is beyond question that this too establishes a serious violation of the mandate. In addition, the Tribunal’s failure to hear the parties with regard to its own – beyond the debate of the parties – approach is contrary to public policy.

(d) ***The valuation dates were determined in violation of Article 13 ECT***

930. Article 13(1) ECT prescribes as mandatory that the “*compensation*” for “*Expropriation*” “*shall amount to the fair market value of the Investment expropriated at the time immediately before the Expropriation or impending Expropriation became known in such a way as to affect the value of the Investment (...)*”, that is to say, immediately preceding the expropriation.
931. However, the Tribunal ruled that HVY were entitled to compensation of the loss as on the expropriation date or as on the date of the award, depending on which valuation would be higher.¹⁶¹² This decision by itself already qualifies as a violation of the mandate and therefore justifies the setting aside of the Yukos Awards under Article 1065(1)(c) DCCP.
932. Indeed, the provision of Article 13(1) ECT is part of the Tribunal’s mandate. However, the Tribunal did not consider itself bound to this. It posited that this Article applies only to

¹⁶¹⁰ Final Awards, marginal no.1802.

¹⁶¹¹ See §§ 891 et seq.

¹⁶¹² See Final Awards, marginal no. 1769.

“lawful expropriations” and that general public international law prescribes that, in case of “unlawful expropriation”, it is free to choose between valuation as on the expropriation date and valuation as on the date of the award.¹⁶¹³

933. But Article 13 ECT does not distinguish between “lawful” and “unlawful” expropriation; it merely speaks of “expropriation”. Consequently, this Article is a *lex specialis* to the general public international law. Moreover, the Tribunal’s approach results in an arbitrary and punitive loss assessment, as the assessment date is in no way related to any disputed conduct on the part of the Russian Federation, but solely to the coincidental date on which the Final Awards were rendered.¹⁶¹⁴
934. HVY’s defence – that the Russian Federation’s reliance on this violation of the mandate is “impermissible” because it “was not argued until the setting aside proceedings”¹⁶¹⁵ – does not hold. The Russian Federation most certainly noted during the Arbitrations that the date immediately preceding the expropriation should be followed, and that the date of the final awards violated Article 13 ECT.^{1616/1617}

(e) ***The Tribunal's use of its own methodology without hearing both parties had substantial consequences***

935. The Tribunal’s decision to use a methodology of its own which was not presented by either party and on which they could neither have reacted in advance, is a serious violation of the mandate and of the public policy, which has had unacceptable consequences for the awarding of the damages. In the context of the award of the damages, this conduct also had far-reaching consequences. For instance, the Tribunal, in applying its own methodology to

¹⁶¹³ See Final Awards, marginal nos. 1763-1769 and the echo of HVY in the SoA, §§ 782-783.

¹⁶¹⁴ For more details, see also Writ, §§ 465-467 and SoR, §§ 466-476.

¹⁶¹⁵ SoA, § 782.

¹⁶¹⁶ Respondent’s Rejoinder on the Merits, § 1666: “When addressing an alleged expropriation, the valuation date should be when the purported substantial deprivation of the investor’s investment has occurred [sic].” (**Exhibit RF-03.1.B-5**). See the confirmation of this in the Final Awards, marginal nos. 1735, 1739: “Respondent also rejects Claimants’ submission that the date of an award can be used as alternative valuation date.”, and 1740.

¹⁶¹⁷ Finally, HVY ignores with their statement that such violation of Article 13 ECT is not a violation of the mandate (SoA, § 784) what the Russian Federation has argued on that by its SoR (see, amongst other, SoR, § 410 and footnote 685).

calculate the dividends, did not consider the inextricable link – expressly acknowledged by Mr Kaczmarek in the Arbitrations – between dividends and equity value.¹⁶¹⁸

936. The amount of profit (or cash) generated by a business depends primarily on the operational performance of the business. This profit can then be distributed as dividends or be kept in the business as equity value. Profits, dividends and equity value are therefore connected. That dividends and equity value are connected is of significant importance to the loss assessment, because the loss consists of both lost dividends and equity value.¹⁶¹⁹
937. Here, too, HVY deliberately ignore the essence of the case; it is not about the fact that the Tribunal assessed the dividends and equity value of Yukos “*separately from one another*”¹⁶²⁰. The point is that the Tribunal treated the items independently, while even HVY’s own expert, Mr Kaczmarek, explicitly acknowledged that these items depend on each other.
938. The Tribunal twice ignored the important – inherent – connection between profit, dividends and equity value in its own method of loss calculation. As a result of that the Tribunal awarded HVY billions of dollars of unfounded damages. In sum:
- (a) the Tribunal neglected to implement its corrections of the dividends in the equity value; and
 - (b) the Tribunal counted loss twice, namely as dividend and as equity value.

Re a: dividend corrections not implemented in equity value

939. In the calculation of the lost dividends, the Tribunal identified a number of factors that it believed would have negatively affected Yukos’ performance and would have resulted in dividends lower than those purported by Mr Kaczmarek.
940. First, the Tribunal had to agree with Professor Dow’s comments to Mr Kaczmarek’s starting points and calculations:

¹⁶¹⁸ See also the Dow Report (Writ) (**Exhibit RF-85**), in particular §§ 57 et seq. Hermes’ 2017 Expert Opinion (**Exhibit RF-D19**), §§ 121, 122, 131-133; Prof. Dow’s 2017 Expert Opinion (**Exhibit RF-D18**), Chapters III and IV.

¹⁶¹⁹ See also Hermes’ 2017 Expert Opinion (**Exhibit RF-D19**), §§ 104-105; Expert Opinion of prof. Dow 2017, §§ 26-31 (**Exhibit RF-D18**).

¹⁶²⁰ SoA, § 776.

“In his second report, Professor Dow identifies and explains a ‘series of errors’ embedded in Claimants’ DCF valuation of Yukos. Although not all of those ‘corrections’ apply to the cash flows discussed above, (...) some of the ‘corrections’ (...) in the view of the Tribunal, do impact the cash flows.”¹⁶²¹

941. Second, the Tribunal held that Mr Kaczmarek had not or not sufficiently accounted for several risks to Yukos’ performance:

“The Tribunal has formed the view that Professor Dow’s corrections, however, do not take into account all the risks that Yukos would have had to contend with in carrying on business during the period 2004 through to the present if the company had not been expropriated. Those risks must be factored back into the cash flow model in the ‘but for’ scenario.”^{1622 1623}

942. With due observance of these factors, the Tribunal reduced the dividends to be awarded compared to Mr Kaczmarek’s calculation:

“In light of all the circumstances, and taking into account: (a) the figures based on Mr. Kaczmarek’s calculations; (b) the figures based on Professor Dow’s ‘corrections’; and (c) the additional risks described above, which the Tribunal finds must be factored into its damages analysis, the Tribunal, in the exercise of its discretion, concludes that it is appropriate to determine and fix the dividend payments that it assumes Yukos would have paid to its shareholders in the ‘but for’ scenario in the amounts set out in the far right column of the following table (...)”¹⁶²⁴

943. The Tribunal therefore ruled that these factors would have negatively affected the performance and profitability of Yukos – and therefore its ability to pay dividend. However, if a business performs suboptimally, this affects not only the amount of the dividends, but also the equity value of the business. The business simply generates less shareholder value, whether this be in the form of distributable dividend or value that remains in the company.¹⁶²⁵

¹⁶²¹ Final Awards, marginal no. 1800.

¹⁶²² Final Awards, marginal no. 1803.

¹⁶²³ The argument of HVY (SoRej., §§ 301-302) that the corrections applied by the Tribunal had already been proposed by Professor Dow and thus were not novel, are belied by this statement of the Tribunal. The Tribunal indeed admits loud and clear that it invents risks itself.

¹⁶²⁴ Final Awards, marginal no. 1811.

¹⁶²⁵ See also Prof. Dow's 2014 Expert Opinion (**Exhibit RF-85**), §§ 104-106.

944. In that context, the Tribunal should have been consistent and should have implemented the adjustments it made in the dividend calculations, based on the risks identified by the Tribunal, in the equity value calculation as well.¹⁶²⁶
945. That, as HVY argue,¹⁶²⁷ the Tribunal assessed the lost dividends in view of the period preceding the reference date and the equity value for the period as of the reference date does not change this in the slightest; a lower corporate performance negatively affects both the ability to pay dividends (in advance of the reference date) and the equity value (on the reference date).
946. Because the Tribunal did not reason the extent of its corrections for the additional risks identified by the Tribunal itself, it is impossible to even determine by approximation the impact of the individual risks on the performance of Yukos. For the same reason, it is impossible to even determine by approximation the impact of the dividend corrections made to include the risks that should have been on the equity value. However, a conservative calculation by Professor Dow shows that the Tribunal's dividend corrections should have resulted in a downward adjustment of the damages for lost equity value alone of at least USD 1.4 billion.¹⁶²⁸ In other words, at least USD 1.4 billion of the damages accorded to the equity value of the shares was wrongly awarded by the Tribunal.

Re b: loss counted twice

947. The Tribunal's decision not to hear the parties on its new methodology resulted in a second error in the loss calculation with even greater consequences.
948. *You can only spend a dollar once.* This basic tenet of finance is what the Tribunal violated when it failed to apply it to Yukos in connection with its dividend calculations. Yukos

¹⁶²⁶ Professor Dow even indicated this in his report. He provided a spreadsheet with which the effects of his various points of criticism could be calculated (Second Dow Report (**Exhibit RF-03.1.C-2.4.1**), Appendix 1). In that spreadsheet, every change was automatically implemented for both the equity value and the *Free Cash Flow to Equity*, which was the basis for the dividends. It is exactly that spreadsheet that the Tribunal used to calculate the dividends (see Final Awards, marginal 1800, footnote 2401 and Annex A1). Based on that spreadsheet alone, it should already have been clear to the Tribunal that the corrections to the dividends should also be considered in the calculation of the equity value – the first page of Annex A1 to the Final Award (the result of the Tribunal's changes to Professor Dow's spreadsheet) even explicitly states that the corrections have a negative effect on the equity value ("*enterprise value*").

¹⁶²⁷ See also SoA, § 776.

¹⁶²⁸ See Dow Report (Writ) (**Exhibit RF-85**), § 116.

UNOFFICIAL TRANSLATION

This text is an unofficial translation of the Dutch original. In case of any discrepancies, the Dutch original shall prevail.

could either distribute a dollar of the available funds (*free cash flow to equity*) as dividend, or keep it in the business as equity value. Dividend and asset value are therefore inversely proportionate – a business that distributes more dividend than another business (in the form of a higher dividend yield)¹⁶²⁹ will, *ceteris paribus*, have a lower asset value and a lower growth in asset value. A dollar cannot be counted both as a dividend paid and as retained equity.

949. In his calculation of the dividends using the DCF model, Mr Kaczmarek started from a hypothetical situation in which Yukos distributed all available funds as dividends. Mr Kaczmarek explicitly acknowledged that this was a hypothetical assumption and not a realistic representation of facts:

“As a practical matter, we recognize that not all of the free cash flows to equity generated by YukosSibneft would have been issued as dividends to the shareholders, and a portion of this free cash flow would have been invested in positive net present value (NPV) initiatives such as development of existing properties or acquisition of new properties.”¹⁶³⁰

950. According to Mr Kaczmarek, this unrealistic assumption underlying Mr Kaczmarek’s method was ultimately not onerous, as the overestimation of the dividends was compensated with a lower equity value on the basis of the same DCF model:

“However, since our valuation of YukosSibneft does not consider such reinvestments of free cash flows, it is reasonable to assume these free cash flows would have been issued as dividends. Said differently, if a portion of these free cash flows had been invested in positive NPV initiatives in lieu of dividends, then our equity value for YukosSibneft calculated in Section X would have been proportionately higher.”¹⁶³¹

951. Accordingly, Mr Kaczmarek explicitly acknowledged that there is a direct connection between dividend and equity value: if a company, hypothetically, distributes all of its available funds as dividends, this will result in a lower equity value than compared to when a company does not do this.

¹⁶²⁹ The *dividend yield* stands for the relative degree to which a business distributes dividend compared to its equity value. See also Expert Opinion of prof. Dow 2014, § 58 (**Exhibit RF-85**).

¹⁶³⁰ First Kaczmarek Report (**Exhibit RF-03.1.C-2.1**), § 392, footnote 488. ‘YukosSibneft’ is the designation HVY use to refer to the result of the alleged merger between Yukos and Sibneft – which, incidentally, never actually took place.

¹⁶³¹ First Kaczmarek Report (**Exhibit RF-03.1.C-2.1**), § 392, footnote 488.

UNOFFICIAL TRANSLATION

This text is an unofficial translation of the Dutch original. In case of any discrepancies, the Dutch original shall prevail.

952. If, for the sake of argument, the Tribunal had followed Mr Kaczmarek's method and had compensated the overestimation of the dividends with a lower equity value, there would, to that extent, not have been an overestimation of the loss 'on the bottom line'.
953. However, the Tribunal did not apply Mr Kaczmarek's method. As explained above,¹⁶³² the Tribunal instead chose to (a) use the DCF model to calculate the dividend, (b) and, additionally, to use the comparable companies model to calculate the equity value and (c) to extrapolate the equity value determined as per 2007 with the aforesaid comparable companies model to 2014 (the (never mentioned before) date of the final awards) by means of the RTS Oil & Gas Index.
954. Unlike Mr Kaczmarek's DCF model, the comparable companies method does not provide for a compensation mechanism for an overestimation of dividends. By separating the calculation of the dividends and the equity value, the Tribunal accordingly overestimated the dividends without compensating this in the equity value. In that way, the Tribunal mis-combined the two methods and double-counted for the loss: as lost dividend *and* as lost equity value.
955. In addition, this hypothesis used by the Tribunal -that Yukos would distribute all available assets as dividends - is incompatible with the Tribunal's use of the RTS Oil & Gas Index. By using this Index to extrapolate Yukos' equity value of 2007 to 2014, the Tribunal necessarily assumed that the course of the equity value of Yukos would have followed that of the other companies (Yukos' peers) in the RTS Oil & Gas Index.
956. As explained in paragraph 948, a company that distributes more dividend than its peers, *ceteris paribus* has a lower equity value. If it must be assumed that Yukos had distributed all available funds as dividends, as the Tribunal ruled, this necessarily means that (the growth of) Yukos' equity value would have lagged behind compared to the other companies in the RTS Oil & Gas Index, seeing that companies, including Yukos' peers, would normally distribute only part of the available funds as dividends and reinvest the remainder, as Mr Kaczmarek had explicitly pointed out.¹⁶³³

¹⁶³² See §§ 924, 903, 909.

¹⁶³³ See §§ 949-950.

UNOFFICIAL TRANSLATION

This text is an unofficial translation of the Dutch original. In case of any discrepancies, the Dutch original shall prevail.

957. The fact that the Tribunal awarded Yukos an above-average dividend yield is therefore inconsistent with the Tribunal's assumption that Yukos' equity value would have been in line with the RTS Oil & Gas Index – *either* Yukos would have distributed a higher dividend, as a result of which its equity value would have lagged behind the Index, *or* its equity value would have been in line with the Index, in which case Yukos would not have been able to structurally distribute a higher amount of dividends than its peers in the Index.¹⁶³⁴
958. HVY try to divert attention from this by arguing that the estimate of lost dividends related to the period prior to the reference date and the estimate of the equity value related to the period starting from the reference date.¹⁶³⁵ This, however, does not change the above: indeed, if Yukos, in the years preceding the reference date, had distributed all its available funds as dividends – as the Tribunal assumed, following Mr Kaczmarek – there would have been less equity value remaining on the reference date than compared to when Yukos would have only distributed part of the available funds as dividends.
959. In sum, the Tribunal maintained Mr Kaczmarek's overestimation of the dividends, but neglected to compensate for this overestimation with a downward adjustment of the equity value (or the overestimation of the dividends), despite the fact that Mr Kaczmarek pointed out that this should have been the other side of the coin. Accordingly, the Tribunal awarded part of the damages twice: as dividends *and* as equity value.
960. The graph below, taken from Professor Dow's report accompanying the Writ illustrates the consequences of this error by the Tribunal:¹⁶³⁶

¹⁶³⁴ Expert Opinion of Hermes 2017, §§ 96-113, 139-140 (**Exhibit RF-D19**); Expert Opinion of prof. Dow 2017, Chapter IV and V (**Exhibit RF-D18**).

¹⁶³⁵ SoA, § 776. The assertion in SoA, § 786, that the Russian Federation supposedly waived its argument regarding the double counting is also unfounded and based on a paraphrasing of the Russian Federation's arguments.

¹⁶³⁶ Expert Opinion of prof. Dow 2014, p. 29 (**Exhibit RF-85**).

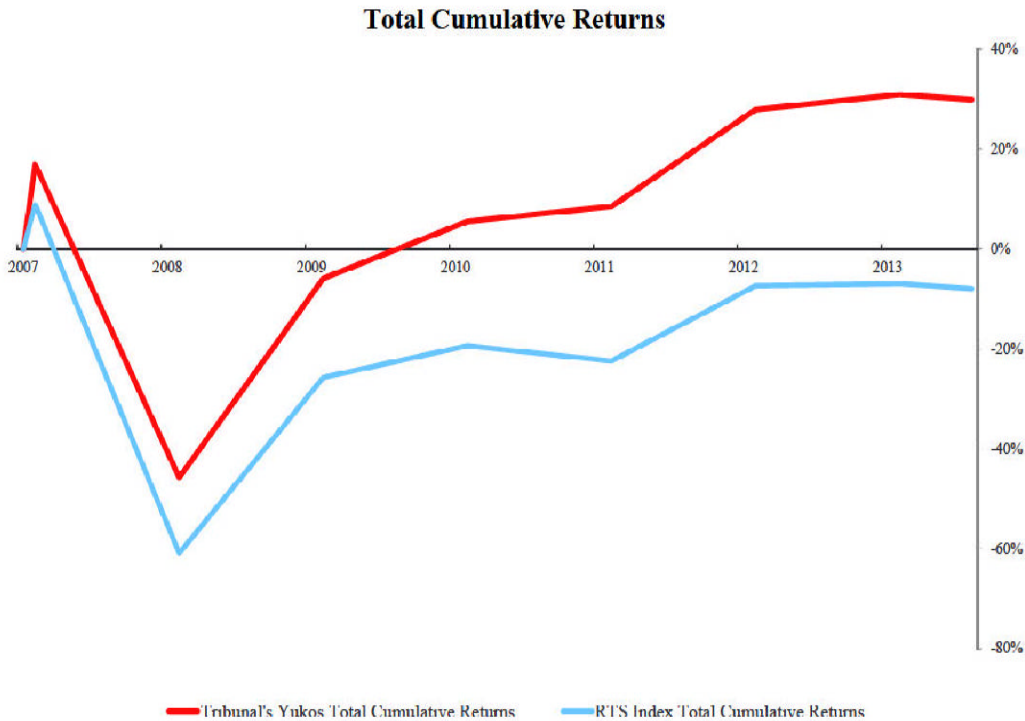

961. The accumulated return (dividend + change in equity value), which the Tribunal granted to HVY, is considerably higher than the return HVY would have achieved if they, instead of investing in Yukos, had invested in the ‘basket’ of shares of the RTS Oil & Gas Index – the index with which, according to the Tribunal, Yukos’ value was in line. Indeed, the overestimation of the dividends in the DCF model was not compensated for by the Tribunal.

962. In his report accompanying the Writ, Professor Dow explains that the double counting by the Tribunal resulted in an overestimation of the damages to be awarded to HVY amounting to USD 20,228,442,495, i.e. over 20 billion dollars¹⁶³⁷ – a staggering amount, which moreover represents over 40% of the total damages awarded by the Tribunal. This analysis is subscribed to by damages expert Kathleen Paisley in her independent commentary to the Tribunal’s loss calculation. This is summarised in the following slide taken from her presentation:¹⁶³⁸

¹⁶³⁷ See also Expert Opinion of prof. Dow 2014, §§ 71-79 (**Exhibit RF-85**).

¹⁶³⁸ Presentation Kathleen Paisley, slide 13 (**Exhibit RF-214**).

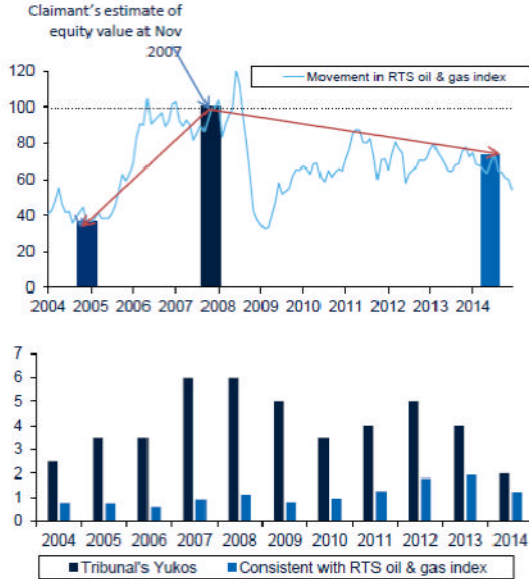

- **What did the Tribunal do? It estimated:**
 - dividends from 2004 to 2014 using the claimant's financial model, which assumed 100% dividend pay-out ratio
 - equity value in 2014 by adjusting claimant's estimate for 2007 with changes in the RTS oil & gas index
- **What is the problem?**
 - the companies included in the RTS O&G index had a dividend pay-out ratio of only 40%
- **What is the consequence?**
 - adjusting for this inconsistency would significantly reduce the damages (\$20bn)

Slide prepared by Oxera
13

963. HVY – and its (newly engaged) expert Giles – try to disguise all of this by misrepresenting the Russian Federation’s argument and making it seem as if the Russian Federation argues that it is completely impossible for Yukos to have distributed more dividends while at the same time having generated more equity value than its competitors.¹⁶³⁹ However, that is not what the Russian Federation argues. The Russian Federation argues that the Tribunal made it seem as if it followed the parties in their method of loss calculation, whereas in reality it constructed a method of its own. This method is simply inconsistent, as the Tribunal, on the one hand, overestimates dividends, which are in turn not compensated in the equity value; resulting in a double counting of billions of dollars.

964. Accordingly, the Tribunal’s decision not to hear the parties regarding its new method of loss calculation has had far-reaching consequences. This once again justifies the setting aside of the Yukos Awards pursuant to Article 1065(1)(c) DCCP. As stated, the facts also

¹⁶³⁹ SoA, §§ 781-789, with reference to Giles’ report (Exhibit HVY-D6). See for the rebuttal of the Expert Opinion of Giles 2017, the Expert Opinion of Hermes 2017, §§ 106-108 (**Exhibit RF-D19**) and Expert Opinion of prof. Dow 2017, Chapter V-XIII (**Exhibit RF-D18**).

form the basis for the setting aside on account of the lack of a tenable reason pursuant to Article 1065(1)(d) DCCP and because the manner in which the Final Awards were made, is contrary to public policy, at least on the issue of the loss calculation, because the Tribunal failed to hear both sides with respect to its self-conceived methodology. This should lead to setting aside pursuant to Article 1065(1)(e) DCCP. As indicated at the start, this is explained in more detail with the relevant grounds.¹⁶⁴⁰

(f) ***Conclusion: the determination of the damage was an inadmissible surprise decision***

965. In short, the Tribunal used undiscussed reference dates and applied its own method to determine HVY’s damages. These differed from the dates and methods advanced by the parties and discussed during the proceedings. The parties have had no opportunity to respond to these dates and this methodology. Moreover, the parties could not have expected the Tribunal to apply this methodology. The Tribunal thereby issued an inadmissible surprise decision. It should have heard the parties when it had devised new damage calculation methods. This course of events has furthermore led to serious errors in the calculation. Over 20 billion dollars in damages has been awarded twice. The Tribunal thereby violated its mandate, and it renders the Yukos Awards contrary to public policy. Accordingly, the Yukos Awards must be set aside pursuant to Article 1065(1)(c) and (e) DCCP.

E. Mandate Ground 3 – The Tribunal did not personally fulfil its mandate and consequently the Tribunal was incorrectly composed (Article 1065(1)(c) and (b) DCCP)

The Russian Federation refers to:		
<u>Arbitrations:</u>		
-		
<u>Setting aside proceedings:</u>		
Writ	Chapter V.E	§§ 468-509
SoD	Part I, Chapter 3.4.4	§§ 168-177
	Part II, Chapter 3.3	§§ 597-630
SoR	Chapter IV.E	§§ 477-625
SoRej	Chapter 3.4	§§ 350-373
RF Pleading Notes	Chapter VIII	§§ 94-114
HVY Pleading Notes	Chapter 4	§§ 147-158
SoA	Part II, Chapter 12	§§ 792-804

Primary exhibits:	
<u>Arbitrations:</u>	

¹⁶⁴⁰ See Chapter VI.C and Chapter VII.C, respectively.

-	-
<u>Setting aside proceedings:</u>	
RF-189	Chaski I (Research)
RF-215	Chaski II (Reply Report)
RF-D20	Chaski III (Response)
RF-D21	Daelemans I (Review Report)
RF-D22	Daelemans II (Research)

Essence of the argument

- The disproportionately large number of hours (2625) invoiced by the Assistant (Valasek) in phase 2, seen in relation to that of the three Arbitrators themselves (on average 1661) and that of the two administrative/organisational Secretaries (together 5232), shows that, from a legal perspective, Valasek has made an unacceptably large contribution to the *substance* of the Final Awards, for which he received as much as nearly €1 million.
- The unacceptably large contribution of the Assistance to the substance of the Final Awards also becomes clear from the results of the two independent studies by linguistic experts (Dr C. Chaski and Professor W. Daelemans). Their computer analysis-based studies of three chapters of the Final Awards that are crucial to the outcome of the Arbitrations show with over 95% certainty that – depending on the methodology applied – 60 to 70% and at least 41% of these chapters has been written by the Assistant; instead of by the Arbitrators themselves. The criticism of Dr. Chaski’s studies expressed by HVY’s experts turns out to be unfounded.
- Even according to the more liberal (minority) view on the delegation of tasks by a arbitral tribunal to its secretary, all findings that are decisive for the substantive decisions must be formulated by the arbitral tribunal itself. This is because the proof of the pudding is in the arbitral tribunal formulating its own decision and reasoning, while those relying on drafts of others cannot assess whether the accounts given therein are biased and/or incomplete.
- Insofar as exceptional circumstances even allow for a deviation hereof, this requires the ‘informed consent’ of the parties. This consent has been neither requested nor obtained in this case.
- The Tribunal has violated its mandate by violating this requirement/condition. At the same time, this *in fact* caused the Tribunal to adjudicate important aspects of the case with four arbitrators. HVY cannot refute these serious violations of

Article 1065(1)(b) and (c) DCCP with a reliance on estoppel, referring to ‘scribes’ at regular courts and a ‘practice’ in the international arbitration practice, or with the speculation that the Tribunal had ‘complete control’ of Valasek’s contributions to the final Awards before he wrote them and after he submitted them.

(a) ***Introduction and overview of delegation reproach***

966. The Russian Federation maintains in full the substantiation it provided in the first instance for these grounds for setting aside, as enshrined in Article 1065(1)(c) or (b) DCCP. In addition, it maintains its previous offers of evidence and its disputations of the defences advanced these grounds by HVY. For the Court of Appeal’s convenience, the Russian Federation will present the essence of its earlier argument once again in this chapter, without prejudice to the devolutive effect of the appeal. The Russian Federation will supplement this with the refutation of what HVY advanced in their defence before, in and with their statement of appeal.

(a)(i) *The core reproach underlying both grounds for setting aside: delegation of the core task*

967. The Russian Federation reproaches the Arbitrators for a fundamental failure to comply with their mandate. In material respects, the Arbitrators did not fulfil their most important substantive task personally (*‘intuitu personae’*) at all or not to a sufficient extent. This core task of arbitrators is about *personally* assessing *all* points of dispute on the basis of their *own* examination of the *entire* case file and formulating *all* decisions *themselves* on the basis thereof. Just as in the first instance, the factual and legal substantiation of this *‘failure to comply with the mandate’* (invoked as a third sub-ground) also serves as substantiation of the independent ground for setting aside that is the *‘incorrect composition of the Tribunal’*. Without prejudice to the legal distinction between the two, the actual essence of the invocation of both grounds for setting aside is identical in this case.

968. This actual essence is that Arbitrators – without having been transparent in this respect and therefore *a fortiori* without the parties’ consent – have delegated their substantive core task to an assistant to an unacceptable degree. The said assistant was Canadian lawyer Martin Valasek, who at the time of his appointment was a colleague of the Chairman of the Tribunal, Mr Fortier.

969. On the basis of the Terms of Appointment proposed by the Arbitrators, the parties had agreed with the appointment of two staff members of the Permanent Court of Arbitration (“PCA”) as administrative-organisational secretaries, who were already well-familiar with this task. Mr Fortier’s statement that, in addition, he had already appointed his colleague Valasek as his assistant to be paid by the parties therefore came as a total surprise and, moreover, as a *fait accompli*. This has not been protested, since the Chairman described Valasek’s task as merely that of a personal assistant and contact for the parties.
970. Fortier explained that if he should be unavailable due to his many international travels, and the PCA Secretariat were unable to answer a question, then Valasek might know the answer.¹⁶⁴¹

“I would like to bring to the attention of the parties that I have asked one of my colleagues in my office in Montreal to assist me in the conduct of this case. Because, like of all us, I travel a lot, if at any time I am unreachable, you could always contact him.”

At no time during the lengthy further course of the arbitration proceedings did the Tribunal make any statement to the effect that Valasek would also be carrying out substantive tasks. In formal statements issued in April and November 2015, Fortier even explicitly disputed that Valasek also carried out substantive tasks.¹⁶⁴²

971. Chapters IX (Preliminary Objections), X (Liability) and XII (Quantification of Claimants’ Damages) of the Final Awards saw the resolution of a number of disputed issues that were of essential importance to the outcome of the Arbitrations. These decisions resulted in the order for the Russian Federation to pay HVY damages in the amount of US\$ 50 billion. The texts of in any event these three essential chapters have been written largely by Valasek, rather than by one or more of the Arbitrators, which is contrary to the substance and nature of the Arbitrators’ mandate.

¹⁶⁴¹ See also, in somewhat more detail, the quote from the court record of the first hearing on 31 October 2005, stated in § 488 of the Writ.

¹⁶⁴² Although HVY suggest that statements were made about this to the parties, they fail to provide any concrete reference, other than that Fortier thanked Valasek for his support at the end of the hearings. Closing hearing, phase I: “*Valasek assisted and supported the Tribunal and will continue to do so.*” Closing hearing, phase II: “*Valasek is a complete assistant.*”. See SoA, § 795 and SoD, § 621; for more on Fortier’s assertion that Valasek had no influence whatsoever on the decisions of the Tribunal and wrote not a word of the Award, see: § 983 of this defence on appeal.

972. The Russian Federation has already produced the evidence for this unauthorised delegation in the first instance and will further supplement and explain that in the present defence on appeal. This evidence consists of:

- (a) the PCA statement on behalf of the Tribunal of the respective hours spent on these Arbitrations by the Arbitrators, the assistant and the PCA Secretariat, and
- (b) the objective results of the earlier linguistic study into the Final Awards, and the computer analysis-based linguistic ‘stylometric’ study thereinto for the benefit of this Defence of Appeal.

(a)(ii) *The evidence for the main reproach emerging from the time sheet*¹⁶⁴³

973. According to the time sheet that the PCA Secretariat only submitted, at the request of the Russian Federation, after the Final Awards had been rendered, the assistant – according to his own statements – spent over 60% more time on these Arbitrations than the ‘average Arbitrator’; this means over 25 full working weeks *more*. In turn, both PCA Secretaries of the Tribunal spent over 70% more hours on the organisation and administration of the Arbitrations than assistant Valasek’s total efforts in these proceedings.

974. These major discrepancies in terms of time spent (more about which later, including the exact hours¹⁶⁴⁴) lead to the undeniable factual evidence of the main reproach under these grounds for setting aside. Indeed, Valasek did not spend any relevant time on the organisation and administration of the Arbitrations, which – in conformity with the agreement between the Tribunal, the parties and the PCA laid down in the Terms of Appointment – was handled entirely by the PCA Secretariat. This means that Valasek must have spent the more than six months (!) that he worked longer on the Arbitrations than the Arbitrators on the substantive aspects of the Arbitrations. And this substantive work must have also included the preparation of the design of substantive parts of the Final Awards. The following serves as an explanation for this observation.

975. Except for the first case management hearing, Valasek attended all meetings together with the three Arbitrators. Therefore, on balance, he spent a little less time on that than the

¹⁶⁴³ For this time sheet, see § 984 below. See, previously, the Writ, §§ 491 et seq. and SoR, §§ 504 et seq.

¹⁶⁴⁴ See § 984 below.

Arbitrators. Moreover, on the whole, Valasek will certainly not have needed more time than the Arbitrators themselves to read the procedural documents.¹⁶⁴⁵ The enormous surplus of Valasek's hours compared to those of the Arbitrators furthermore cannot be explained from the summaries – which *perhaps* he himself drew up – of the respective parties' positions and relevant legal sources. This task that is sometimes entrusted to a *secretary*¹⁶⁴⁶ undeniably requires just a fraction of the time that is inevitably required in the 'iterative' decision-making process always entrusted exclusively to arbitrators: thinking about, discussing, formulating, substantiating, reconsidering, amending, finalising and completing the many decision points that are at issue in arbitrations.¹⁶⁴⁷

976. The huge difference between the time involved in these two types of work (in short: summarising and assessing), which are fundamentally different, is all the more accentuated in these Arbitrations. Indeed, as evidenced by the arbitration documents submitted in the first instance, the parties had already submitted all their own summaries of their own procedural positions and all legal sources cited by them¹⁶⁴⁸ had already been annexed to their procedural documents. A simple calculation shows that, as (i) the total number of session hours¹⁶⁴⁹ and reading hours of each Arbitrator must have been largely consistent with that of the assistant, and as (ii) the combination by a gifted assistant of already available factual and/or legal summaries for a number of disputed points may require only a fraction of the time required for the finalisation of the entire 'iterative' decision-making process in respect of all disputed points, while (ii) the assistant – just like the Arbitrators – did not have to spend any relevant time to the organisation and administration of these Arbitrations, the significant number of surplus hours (25 full working weeks) of the

¹⁶⁴⁵ The Russian Federation notes in this respect that it is not normally the job of an assistant or secretary to read all the procedural documents himself, let alone to have them do this as thoroughly as arbitrators themselves have to.

¹⁶⁴⁶ It should be stressed that Valasek was not one of the two regularly appointed (PCA-) secretaries of the Tribunal, but an assistant with – as far as the parties had been informed – tasks relating purely to the communications between the parties and the Tribunal besides organisational support to Arbitrators. There is a difference of opinion in the literature and in practice as to whether making substantive summaries and/or analyses of the factual and/or legal positions of the parties can be an 'appropriate task' of a secretary, as such work inevitably implies the adoption of substantive positions on the points in dispute.

¹⁶⁴⁷ More information on the grounds on which these substantive tasks are reserved exclusively for the arbitrators can be found in Part V.D.2 below.

¹⁶⁴⁸ Reference is made to the case law of domestic courts and tribunals, professional literature from numerous jurisdictions, as well as treaties' histories and legislative histories.-

¹⁶⁴⁹ Valasek did not attend the first hearing of 31 October 2005.

assistant compared to the ‘average’ arbitrator cannot have been spent any differently than on the preparation of draft versions of the Final Awards.¹⁶⁵⁰

977. For the assessment of the gravity of this delegation reproach, the following is relevant, as will be clarified below.

- (a) The position of “assistant”, which is not regulated by law or the regulations of the arbitration institutes, may therefore, by its nature, include considerably fewer responsibilities than that of the “secretary”, which position has in fact been stipulated in the law and many regulations.
- (b) The Tribunal has never proposed to the parties, let alone obtained their consent, that Valasek, who was introduced to them merely as a support for the communication and organisation of (the President of) the Tribunal, would have any substantive task in the preparation of the Arbitrators’ decision-making process.¹⁶⁵¹
- (c) The assertions under (a) and (b) do not affect the fact that the lawyers of the parties were aware of the more frequent engagement of secretaries by other tribunals for supporting legal activities, such as drafting factual and/or legal summaries, reports and/or checklists for internal deliberations of the tribunal, etc. Indeed, first of all, Valasek was never presented to the parties as such, and second, these grounds for setting aside are not aimed against such activities of a secretary.

978. It was not until after the Final Awards were rendered and the Russian Federation learned of the absolute and relative extent of the hours invoiced by Valasek that the Russian Federation became aware of his major substantive contribution to the Tribunal’s decision-making process. That is why the Russian Federation could not have protested against this violation of the delegation prohibition by the Tribunal during the arbitration proceedings already either. The fact – and even the possibility – of this prohibited delegation simply

¹⁶⁵⁰ HVY did not even allude to the circumstance that Valasek – without this being noticed by the PCA Secretariat or the Tribunal – charged his hours "double" and/or that the Arbitrators waived their compensation for a considerable number of hours they worked on this case.

¹⁶⁵¹ For this introduction of ‘assistant’ Valasek by president Fortier, see the Transcript of the procedural hearing October 31, 2005, 92:19-93:6. See also Writ § 488 and § 969 above. Aside from the usual compliments for his assistance and support, the Tribunal never communicated anything about the more substantive tasks assigned to Valasek – not at any later stage either. See once again Fortier’s assertions cited in § 983 below.

was not known before then. This means that there is no ground for HVY's reliance on estoppel.¹⁶⁵²

979. This prohibited delegation of substantive arbitral duties is demonstrated not only by the stylometric survey to be discussed below, and the time sheet of the PCA Secretariat, but it has also been implicitly acknowledged by the PCA Secretariat. Indeed, this acknowledgement follows from the PCA Secretariat's substantiation as to why the Tribunal did not allow the PCA Secretariat to provide the additional specifications explicitly requested by the Russian Federation. This specification request pertained to the provision of an overview of the activities that had been distinguished exclusively in terms of 'type' – so not in terms of 'substance' – to which the hours charged by, among others, Valasek as from early 2009 (such as 'reading', 'attending hearing' 'legal research', etc.).¹⁶⁵³

980. However, such an overview was refused and the statement was limited to the total number of hours and expenditures of each arbitrator, Valasek and the PCA. The substantiation hereof read (emphasis added by lawyer):

“In the view of the Tribunal, the attached Statement of Account provides the Parties with the appropriate level of detail while assuring the confidentiality of the Tribunal's deliberations.”¹⁶⁵⁴

981. The further specification request submitted on behalf of the Russian Federation on 7 October 2014 advanced the following against this, among other things (emphasis added by lawyer):

“We write to reiterate our request for the additional information and invoices (...). None of the requested information or invoices would infringe upon the confidentiality of the deliberations of the Tribunal. Respondent requested a description of work performed by type or category (...) Whatever may be said concerning the confidentiality of the deliberations of the Tribunal, those concerns do not extend to the PCA or the Assistant, who undoubtedly have submitted time records and invoices that can be readily provided.”

¹⁶⁵² For the inaccuracy of this undocumented defence advanced by HVY in Statement of Defence, §§ 175-177 and §§ 619 et seq., SoRej., §§ 371-373, and SoA, § 792, see among others SoR, §§ 564-588, and this Defence on Appeal, §§ 1019-1035. It is remarkable that, for this defence, HVY rely on, *inter alia*, non-existent or irrelevant articles, such as Articles 1064(4), 1054(4) and 1064(1)(c) DCCP. It can be assumed that HVY only refer to Article 1065(4) DCCP.

¹⁶⁵³ See paragraph 3 of the letter dated 9 September 2014 from a Russian Federation lawyer to the Deputy Secretary-General of the PCA.

¹⁶⁵⁴ For this dismissive answer on behalf of the Tribunal, see the letter from the PCA Secretariat to the lawyers of parties dated 6 October 2014.

This further request with explanatory notes on the part of the Russian Federation did not change the refusal and substantiation hereof by the PCA and the Tribunal, respectively.¹⁶⁵⁵

982. This substantiation of the rejection of this request can only be interpreted as meaning that, according to the Tribunal and the PCA, such a specification would allegedly show that Valasek had contributed to the substantive deliberations and decision-making process of the Tribunal.¹⁶⁵⁶ After all, no other grounds on which to reject the specification request have been advanced, and cannot be justified either, especially not towards the party that ought to pay these very considerable charges. This is all the more cogent now that it must be assumed that Valasek himself probably specified the hours worked, at least broadly, as is customary in the legal profession.
983. The completely unsubstantiated denial by, Fortier, the Chairman of the Tribunal, of any ‘substantive role’ fulfilled by Valasek, which denial was given later and outside the scope of these proceedings, therefore should not be taken seriously in any way (emphasis added by lawyer):

“(…) Mr Valasek undertook numerous tasks assigned to him by the Tribunals, including summarizing evidence, researching specific issues of law and organizing the massive case file (…). Mr Valasek was not involved and did not play any role in the Tribunal’s decision-making process.”¹⁶⁵⁷ and

“Mr Valasek did not write the tribunal’s reasoning and conclusions of the Yukos awards.”¹⁶⁵⁸

984. These statements by Fortier are incompatible with the reasons given, partly in his name, for rejecting the Russian Federation’s request for a purely ‘typological’ account of the hours declared by Valasek: “*assuring the confidentiality of the Tribunal’s deliberations*”. Nor are

¹⁶⁵⁵ For the sources of this correspondence, see footnote 1654.

¹⁶⁵⁶ As will be explained below in part V.D.2, a secretary’s mere attendance at the ‘deliberations in chambers’ of arbitrators is not forbidden, provided the secretary does not take part in these deliberations, but limits himself to keeping minutes and, if so requested, handing over documents.

¹⁶⁵⁷ See SoR § 547 with footnote 703 and the reference to Exhibit RF-195 (Annex B, under 6). This concerns a statement made by Fortier in April 2015, in response to an objection request filed against him in the ICSID case *Conoco/Venezuela*. In that objection request, reference was made to the complaints of the Russian Federation in these setting aside proceedings concerning the Tribunal’s delegation of its duties to Valasek.

¹⁶⁵⁸ Letter of Fortier dated 20 November 2015, written with reference to a new challenge in the same case as stated in footnote 1657. (**Exhibit RF-394**) to this Defence on Appeal.

Fortier's communications consistent with the enormous discrepancy between those hours from the beginning of 2009 (following the final hearing of phase I in December 2008) of Valasek (2625 hours) and those of the Arbitrators Fortier, Poncet and Schwebel (1592, 1540 and 1852 hours, respectively), also in the light of the hours of the PCA Secretariat (5232).

985. HVY's defence that builds on from this unconvincing denial by Fortier¹⁶⁵⁹ is therefore itself unconvincing as well. Moreover, it is even inconsistent where they also assert that Valasek's substantive contributions to the decision-making of the Tribunal are entirely in keeping with the 'demands' and 'customs' of the international arbitration practice, that these contributions had been made sufficiently clear to the parties in good time, and that these contributions were in line with the design instructions issued to Valasek by the Tribunal or its chairman.¹⁶⁶⁰ Moreover, according to the quotes in § 983 above, Fortier himself does not support HVY in any of these defences.

(a)(iii) *The evidence for the main reproach emerging from the linguistic study*

986. The linguistic study that Dr. Carole Chaski performed in 2015 at the instruction of the Russian Federation ('Chaski I') concerns chapters IX, X and XII of the Final Awards.¹⁶⁶¹ Dr. Chaski's study, conducted exclusively with objective computer analyses by means of a statistical comparison of linguistic characteristics of published legal contributions of each of the three Arbitrators and Valasek, proves, according to Dr. Chaski, that it can be said with over 95% certainty that approximately 70% of these three chapters were written by the assistant, and not by the Arbitrators themselves or a combination of them.
987. The Russian Federation's counsel selected these three chapters as research object because they each deal with a legal argument addressing a separate legal issue. As such, this concerns parts of the Final Awards that are both independent, unique and decisive.¹⁶⁶² The

¹⁶⁵⁹ Here, the Russian Federation does not take into account the possibility that Fortier deliberately expressed himself 'in a misleading fashion': (i) Valasek could not play a role in the Tribunal's decision-making process because he was not a member of the Tribunal, respectively (ii) Valasek did not write the reasoning and conclusions of the Yukos awards, because the Final Awards have no chapter titled "reasoning and conclusions".

¹⁶⁶⁰ For these 'inconsistent defences', see, *inter alia*, SoRej. § 795, Pleading Notes HVY § 150; SoA §§ 795 and 797.

¹⁶⁶¹ See **Exhibit RF-189**, SoR, § 532 and Pleading Notes RF I, § 113. See also DoA §§ 1051-1064.

¹⁶⁶² See SoR, §§ 532 et seq.

study is objective because it applies a fixed scientific method, using statistical analyses of language characteristic of the potential authors in legal ‘test pieces’ certainly authored by them to arrive at ‘author recognition’ in respect of, in this case, the three studied chapters of the Final Awards. The presence of these characteristic author attributes, which have been derived from the ‘test pieces’, in these chapters has been examined by digital means. This scientific method (‘stylometry’) is therefore essentially different from the classical, subjective route of largely intuitive style recognition, often supplemented by subjectively controlled measurements, based on criteria conceived *ad hoc* by the researcher himself.

988. For Dr. Chaski’s much more detailed description of the methods used, reference is made to the reports she has issued and submitted to the Court in these proceedings, including the annexes to the reports. See ‘Chaski I’ (2015) chapter III and ‘Chaski II’ (2016) chapters II-IV. See furthermore – more on which below – Dr. Chaski’s ‘Response’ report (Chaski III 2017), submitted with this Defence on Appeal (Chaski III 2017, *passim*, beginning with an ‘executive summary’ and ending with a ‘conclusion’.)
989. Dr. Chaski refuted the layman’s criticism of her first report, as expressed by HVY in Rejoinder, §§ 364 et seq., in an additional report submitted to the court before the pleadings (‘Chaski II’).¹⁶⁶³ She also refuted that criticism in the sense that the second report concerns a follow-up study whereby she applied criteria from HVY’s Rejoinder.¹⁶⁶⁴ The outcome of this follow-up research does not differ significantly from the outcome of her initial research; it again showed Valasek’s predominant authorship for the three chapters of the Final Awards that were analysed. After that, HVY could not report much more than that Dr. Chaski’s work was unreliable because there was *some* difference in outcome when using two different calculation methods. However, this would set one thinking only if the outcome would be the same even when applying different methods.
990. Dr. Chaski wrote an extensive commentary on the highly critical – almost defamatory – second opinion by Professors Coulthard and Grant¹⁶⁶⁵, submitted by HVY with their Statement of Appeal, which commentary is submitted with this Defence on Appeal

¹⁶⁶³ See **Exhibit RF-215**.

¹⁶⁶⁴ For example, Chaski II examined recognisable individual contributions by each of the four potential authors (Valasek and the three Arbitrators), while Chaski I focused on the choice between ‘Valasek’ and ‘Tribunal’. The so-called ‘outliers’ had not been omitted from Chaski III either, which would be better according to Chaski, but looks like ‘manipulation’ according to HVY.

¹⁶⁶⁵ See Exhibit HVY-D6 to SoA, §§ 802-804.

(“Response”; Chaski III).¹⁶⁶⁶ In said commentary, Dr. Chaski shows that Professors Coulthard and Grant’s criticism is scientifically incorrect, inconsistent and biased. For instance, Professors Coulthard and Grant rely on (i) authors who do not support their own criticism of Dr. Chaski in the least and (ii) methodological principles that are easy to refute and moreover inconsistent with their own previous publications. In addition, they (iii) do not hesitate to personally attack Dr. Dr. Chaski for no good reason and (iv) neglected to perform any study of their own into the three Final Awards chapters selected. Professors Coulthard and Grant therefore cannot conclude that Valasek has not been the principal author of those chapters. Their criticism of Dr. Chaski is also characterised by their pure speculations that (i) the legal articles published by Valasek and each of the three Arbitrators under their own names ‘could’ have been edited by third parties, and that (ii) a 5th and 6th (and so on) author ‘could’ have written parts of the three Final Awards chapters. These experts engaged by HVY were apparently not out to verify the ‘key question’ themselves, but merely followed their ‘master’s voice’ (he who pays the piper calls the tune).

991. Professor W. Daelemans (Computational Linguistics) from Antwerp has also written two reports, which are also submitted with this Defence on Appeal, that fully confirm the position of Dr. Chaski and the Russian Federation.¹⁶⁶⁷ In his first report, Professor Daelemans in no uncertain words rejects the methodological criticism expressed by Professors Coulthard and Grant on Chaski I and II. Professor Daelemans also confirms the scientific quality and reliability of Dr. Chaski’s method and her research results, as submitted by the Russian Federation in the first instance. In his second report, based on empirical stylometric research performed according to his own method,¹⁶⁶⁸ Professor Daelemans also essentially confirms the concrete results of Dr. Chaski’s studies; his research also shows that chapters IX, X and XII of the Final Awards were largely written

¹⁶⁶⁶ See new **Exhibit RF-D20**.

¹⁶⁶⁷ See new **Exhibits RF-D21 and RF-D22**.

¹⁶⁶⁸ The first part of that study pertained to the same three chapters of the Final Awards (IX, X and XII) and the same undisputed ‘test’ articles by each of the four potential Final Awards authors (Valasek and the three Arbitrators) previously studied by Chaski, on the basis of statistic-linguistic comparisons between those categories. Professor Daelemans too, studied both the ‘choice’ between Valasek and a combination of Arbitrators and the choice between Valasek and each of the three Arbitrators separately. In the second part of his study, Professor Daelemans expanded the stock of 14 ‘test’ articles (63 ‘sections’) by the four potential authors with 8 of their publications (2 by each, split into 18 ‘sections’).

by Valasek and not by one or more of the Arbitrators.¹⁶⁶⁹ Naturally, all of these reports will be discussed in detail below (Part V.D.3). It should be noted that the Russian Federation maintains its offer to have Mr Valasek, among others, heard as a witness with regard to the hours he claimed and his contribution to the Tribunal's decision-making process. It furthermore offers to have this Court of Appeal hear Dr. Chaski and Professor Daelemans as expert witnesses.

(a)(iv) *The prohibition to delegate the arbitral duty*

992. The law does not allow a tribunal that is composed entirely of experienced legal experts further to the instructions of the parties, and which is moreover supported by professional and experienced secretaries, to delegate the preparation of substantive decisions to an 'assistant'. In the case at issue, this prohibition is based on mandatory Dutch law (the applicable law of the place of arbitration) and the broad international consensus in this respect. This prohibition, which is not mitigated by the ECT- or UNCITRAL rules, is strict and undisputed in the event that such delegation took place without the unambiguous prior permission of the parties on the basis of transparent information provided by the tribunal ('informed consent'). This will – again – be explained below.¹⁶⁷⁰ Hence, this unlawful delegation constitutes an independent ground that supports and completely justifies the setting aside of the Final Awards; namely a material failure to comply with the mandate within the meaning of Article 1065(1)(c) DCCP.

993. The problem that suspected violations of this prohibition on delegation or the '*intuitu personae*' order are often difficult to prove in related cases is not an issue in this case. After all, that proof is readily available here in the form of (i) the undeniable and otherwise inexplicable 'discrepancy' in the hours spent by Valasek on the second phase of the Arbitrations, of (ii) the Tribunal's substantiation for rejecting the Russian Federation's specification request regarding the time invoiced by Valasek ('confidentiality of the arbitral deliberations'), and (iii) the predominant footprint of Valasek's personal style features in the text of the three selected Final Awards chapters, objectively proved by two stylometric studies performed independently and through different methods.

¹⁶⁶⁹ According to Chaski, between 60% and 70% of the three Final Awards chapters and according to Professor Daelemans, between 41% and 62%, all with 95% certainty.

¹⁶⁷⁰ See also part V.D.2 below.

994. This multi-faceted proof is not argued away with the ‘bare’ hypotheses that Valasek merely phrased the conclusions reached orally by the Tribunal ‘in chambers’ and/or that the Tribunal carefully studied Valasek’s drafts and amended them where necessary, before adopting them itself.¹⁶⁷¹ Accepting such a defence is identical to outright scrapping the *intuitu personae* order and the prohibition on delegation to arbitrators. Indeed, any failing arbitrator can in that case get away with the excuse that his/her opinion was sufficiently clear to the arbitral secretary beforehand and appeared to be properly recorded in the arbitral secretary’s draft afterwards.
995. Every ‘minute taker-drafter’ has an undeniably significant personal influence on the recording of decision-making as complex, extensive and coherent as that contained in these Final Awards. For that reason alone, Valasek should not have been engaged to do so without the deliberate and explicit prior consent of the parties. This hypothesis of mere indiscriminate imitation by the Assistant is moreover diametrically opposed to the public and formal statements of Tribunal chairman Fortier – who HVY believe ‘should be taken at his word’¹⁶⁷² – that Valasek played no part in the Tribunal’s decision-making process and did not write any part of the Final Awards.¹⁶⁷³

(a)(v) Delegation to a ‘fourth arbitrator’ also violates the ‘odd number’ requirement and appointment rules

996. Due to this way too far-reaching delegation, the ‘assistant’ Valasek exercised such personal influence on the contents of the Final Awards that, in terms of nature, weight and scope, it can hardly be distinguished from the regular input of an arbitrator. Indeed, his drafts for a large part determined the contents of Final Awards chapters IX, X and XII, which were essential for the outcome of the Arbitrations. This is not altered by the circumstance that, *formally*, he did not have a vote in the ‘hearing in chambers of the Tribunal’. Nonetheless, in view of his significant material influence, he essentially acted *as a fourth arbitrator*. Decisive in this context is not HVY’s mere hypothesis that Mr Valasek’s drafts were perhaps thoroughly controlled (in advance) and checked (in retrospect) by the Arbitrators,

¹⁶⁷¹ As remarked previously, these are only bare hypotheses by HVY themselves. They do not rely on any specific instruction in this respect.

¹⁶⁷² See SoRej., § 359, and SoA, § 794, final sentence.

¹⁶⁷³ See § 983 above for the relevant Fortier quotes.

but indeed that Valasek's contributions determined the substance of the Awards to an important extent.

997. As a result of the prohibited delegation to its assistant, the Tribunal was also *wrongly composed* within the meaning of Article 1065(1)(b) DCCP. Indeed, the role of such fourth co-decider or co-author of an arbitral award is contrary to the mandatory provisions regarding the uneven number of arbitrators, as contained in Article 1026 DCCP and Articles 3 et seq. of the UNCITRAL Arbitration Rules that also apply to these Arbitrations.¹⁶⁷⁴

998. Moreover, the circumstance that the 'assistant' Valasek essentially acted as a *fourth arbitrator* constitutes a material breach of the, likewise mandatory, applicable provisions regarding the appointment of arbitrators, as contained in Article 1027 DCCP and Articles 3 et seq. of the UNCITRAL Arbitration Rules. A person who has not been appointed arbitrator in accordance with the rules applicable to arbitration may not take part in the drafting of the arbitral award.¹⁶⁷⁵ The distinction between the drafting of memorandums with summaries of legal and/or factual views, on the one hand, and the drafting of decisive parts of an award, on the other, is as clear as it is essential. The person who does in fact write material parts of an arbitral award, in addition to the three regularly appointed arbitrators, acts contrary to the rules governing the appointment of arbitrators. In view of Valasek's undeniably significant influence on three crucial chapters of the Final Awards, this violation, too, pursuant to Article 1065(1)(b) DCCP, constitutes an independent ground for setting aside the Final Awards.

(a)(vi) *HVY's defences are wrong, unfounded and inconsistent.*

999. Contrary to what HVY suggest, the fact that such delegation – unauthorised by the parties in advance – is unlawful is not changed by the circumstances

¹⁶⁷⁴ For (the rules regarding) the constitution of the tribunal, refer to chapter I.B (Constitution of the Arbitral Tribunal) and chapter V (Applicable Law) of the Interim Awards of 30 November 2009, which was submitted by the Russian Federation in the first instance as **Exhibit RF-1**.

¹⁶⁷⁵ In principle, exponents of the 'liberal' view on the role of arbitral secretaries do not object to the delegation of the drafting of the 'course of the proceedings' chapter or even 'the facts' to an arbitral secretary, provided such delegation is subject to inspection and adoption by the tribunal itself. Even if one shares that view, even without 'informed consent' of the parties, which is never defended for cases with complex factual points in dispute), it need not be argued that the crucial chapters IX, X and XII of the Final Awards are not included under this type of 'neutral (educational) tests'. See the overviews of §§ 1017 and 1018 below.

- (a) that this case involves complicated, lengthy and extensive proceedings,¹⁶⁷⁶
or
- (b) that some courts in the Netherlands and abroad use the services of ‘scribes’
(clerks),¹⁶⁷⁷ or
- (c) that the Arbitrators, in HVY’s view, supposedly instructed their assistant in
advance and adopted the latter’s drafts as their own decisions – as evidenced
by their signatures to the Final Awards.¹⁶⁷⁸

1000. The prohibition on *substantive* delegation, which also applies to arbitrators in complex and extensive cases, will again be substantiated with sources below. This prohibition cannot be circumvented by an unsubstantiated reliance by the ‘winning party’ on instructions in advance and a check in retrospect with regard to the drafting, outsourced by the arbitrators, of (large parts) of their award.¹⁶⁷⁹ Not only are such ‘limits’ set by arbitrators to their delegation unverifiable for the ‘losing party’ and the reviewing regular court, these limits in any event cannot take the place of the arbitrators’ obligation to read, study, consider, reason, deliberate, redeliberate, and formulate for themselves either. Advocate-General L. Timmerman formulated this as follows in his opinion (no. 3.22) for the ‘*Meavita*’ ruling¹⁶⁸⁰:

“The essence of the judicial work consists not only of rendering the decision and setting out the (most important) grounds of the decision, but also of recording the decision and the substantiation thereof in writing. In that respect, it is not just about the main outlines of the court decision, but also about the – exact – wording in which it has been recorded in writing. The court – or, in case of a multi-judge division: each judge – is responsible for the entire final judgment. Important in this respect is that the written record forces courts to assess the soundness of the solution originally opted for. This is of even greater importance in more complex cases, sometimes involving (a great) many separate decision points.”

1001. HVY’s defence against these grounds for setting aside both based on Article 1065(c) and (b) DCCP, respectively, not only lacks relevant dogmatic support, but is also closely

¹⁶⁷⁶ As argued by HVY in, *inter alia*, SoD Part II, § 602.

¹⁶⁷⁷ As argued by HVY in SoD, §§ 617-618, SoRej., § 357, and Plea Notes HVY, § 150.

¹⁶⁷⁸ As argued by HVY in SoRej., § 358, and SoA, §§ 796-797.

¹⁶⁷⁹ This is true in any case for all ‘substantive’ chapters of an award (as opposed to *possibly* for the neutral listing of facts in a chapter on the course of the proceedings) and *a fortiori* if no unambiguous prior consent was acquired from the parties for such a delegation.

¹⁶⁸⁰ Supreme Court 18 November 2016, *NJ* 2017/202.

related to the textbook example of a use of alternative arguments that is contrary to due process of law. Sued for damages as a result of a car he borrowed but never returned, the ‘defendant’s defence is: “*firstly, I never borrowed a car from you, secondly, the car was already beyond repair when you lent it to me, and, thirdly, I returned the car to you undamaged a long time ago.*” Although there is often nothing wrong with a defence strategy in which alternative arguments play a role, such strategy is subject to both factual and logical limits.

1002. HVY exceed a critical limit by putting forward the combination of the following defences – which are shown below in an abbreviated yet correct manner.

- (a) As the chairman of the Tribunal – who is to be trusted on his word – declared, Valasek had no substantive influence on the formation and contents of the Final Awards.¹⁶⁸¹
- (b) The Russian Federation has not advanced any arguments that can be proved as regards Valasek’s substantive influence and role and should therefore not be allowed to provide proof in this respect.¹⁶⁸²
- (c) The Tribunal made it clear to the parties in good time that Valasek had made and would continue to make substantive contributions to the formation of the Tribunal’s opinion and the Russian Federation did not protest against this at the time.¹⁶⁸³
- (d) The applicable Articles from the Dutch Code of Civil Procedure and the UNCITRAL rules do not prohibit substantive contributions by a secretary or assistant to the awards of ‘his’ tribunal and should therefore be deemed to allow such contributions to awards.¹⁶⁸⁴
- (e) In the international arbitration practice, substantive contributions of a secretary or assistant in extensive cases are not only generally accepted but

¹⁶⁸¹ See SoD, Part II, § 604, SoRej., § 359, and SoA, §§ 794 et seq.

¹⁶⁸² See SoD, Part II, § 598, SoRej., §§ 361 et seq., and SoA §§ 799 et seq.: “*the 10% additional hours claimed by Valasek prove nothing and the stylometric study is faulty.*”

¹⁶⁸³ See SoD, Part I, § 175, SoD, Part II, §§ 621 et seq., SoRej., §§ 371 et seq., and SoA, § 795: “*after all, the Chairman thanked Valasek for his efforts and the Russian Federation did not protest against the Arbitrators’ proposal to increase their fees and Valasek’s fee.*”

¹⁶⁸⁴ See SoD, Part II, §§ 609 et seq., SoRej., §§ 354 et seq., and SoA, § 796.

also inevitable, so that the parties already agreed to this tacitly in advance.¹⁶⁸⁵

1003. These inconsistencies in HVY's defence will of course be discussed in more detail below. The same holds for HVY's last line of defence, namely that the court hearing setting aside proceedings is to exercise great caution in assessing 'violation of the mandate' reproaches and may only give weight to serious violations. In this introductory part, the following general criticism to HVY's defence is nonetheless worth mentioning:

- (a) HVY do not give a reasonable explanation for the established fact that assistant Valasek claimed over 60% more hours than the 'average' Arbitrator (the equivalent of six months' more work), whereas he was not charged with the organisation and administration of the arbitration proceedings at all;
- (b) HVY did not provide substantiated 'scientific' criticism on the linguistic evidence of Valasek's leading role in the wording of three crucial chapters of the Final Awards until the appeal proceedings, yet this criticism is not just artificial, wrong and inconsistent, but does not make an argument for any other outcome regarding the authorship thereof either.
- (c) HVY quote from literature, case law, regulations, recommendations and inquiries on the (alleged) permissibility of a substantive role for assistants in the formulation of arbitral awards in an annoyingly selective and misleading manner.
- (d) HVY either unabashedly use the 'straw man' technique (in other words, a defence against arguments the Russian Federation did not advance), or they make no mention whatsoever of essential arguments of the Russian Federation, or they suffice with a bare repetition of arguments that were already disputed with reasons.

(b) ***The prohibition on delegation of the 'substantive' arbitral task***

(b)(i) *Intuitu personae*

1004. Arbitrators are selected by or on behalf of the parties with great care and based on their specific knowledge, experience, integrity and – last but not least – availability.¹⁶⁸⁶ The

¹⁶⁸⁵ See SoD, Part I, §§ 170 and 174, SoRej., §§ 359 et seq., and SoA, §§ 796-797.

appointment of the chairman of the tribunal is subject to additional safeguards, as the chairman as '*primus inter pares*' often tends to have much more influence on the course of the proceedings, at the hearings, the deliberations in chambers and the wording of the arbitral award. Moreover, the decision of the arbitrators requires extra care and attention because it is final in the sense that an appeal against it is usually excluded and the judicial review is limited.

1005. A fundamental principle is therefore that - in the absence of special agreements with the parties on the basis of their 'informed consent' - the substantive tasks of the arbitrators are strictly personal. It should be noted that there is nothing wrong with the use of secretaries as such by tribunals in the interest of – as Professor Pierre Lalive put it in 1995¹⁶⁸⁷ – "*the economy of time and money in entrusting to a secretary-lawyer administrative tasks such as filing, routine correspondence - communication with the [institute] and the parties under the supervision and the responsibility of the arbitrator*". The Russian Federation never objected to 'more than purely administrative/organisational activities of secretaries' either. However, arbitrators must in any event fully perform all substantive elements of their mandate personally – i.e. *intuitu personae*. The prevailing doctrine in the Dutch and international practice¹⁶⁸⁸ and literature was and is completely clear in this respect; arbitrators may not assign their personal, substantive tasks to another person – not even in part. This involves particularly their personal inspection of the entire case file, their personal decision-making and deliberations among the arbitrators on all points in dispute, their own (re)consideration and (re)formulation of all decisions, including their own reasoning thereof.

¹⁶⁸⁶ See, for example, Article 2.3 'Rules of Ethics for International Arbitrators' of the International Bar Association, which provides that the prospective arbitrator is to accept an appointment "*only if he is able to give to the arbitration the time and attention which the parties are reasonably entitled to expect.*" (emphasis added) Likewise, see the LCIA 'Notes for Arbitrators' (2017), under 10 and 13: "*Parties are also entitled to expect (...) that all arbitrators are not only impartial (...) but that each arbitrator has also checked that any existing or anticipated commitments will permit the arbitrator to fulfil his/her mandate without delay (...) a commitment not only to devote sufficient time to the proceedings (...) but also to draft any award promptly after the last submission of the parties.*" (emphasis added) SoR, §§ 481 et seq. and **Exhibit RF-188** demonstrate, using concrete data, the overloaded programme of most notably Chairman Fortier as – aside from his many other occupations – a professional arbitrator during the course of the present, extremely expansive, complex and time-consuming Arbitrations (at € 750 to € 850 per hour).

¹⁶⁸⁷ ASA Bulletin 4, pp. 634 et seq., translated from French by Constantine Partasides (the "inventor" of the "the fourth arbitrator" concept).

¹⁶⁸⁸ See also, *inter alia*, Professor P. Lalive's expert opinion, 16 July 2010, pp. 8-13, in particular §§ 3.3 et seq. (**Exhibit RF-224**) and §§ 1016 et seq. below.

UNOFFICIAL TRANSLATION

This text is an unofficial translation of the Dutch original. In case of any discrepancies, the Dutch original shall prevail.

(b)(ii) A representative survey confirms the prohibition on delegation

1006. Relatively recent surveys from 2012¹⁶⁸⁹, 2013¹⁶⁹⁰ and 2015¹⁶⁹¹ among persons involved in the international arbitration practice as arbitrators, secretaries, lawyers and/or parties confirm the general applicability and broad level of support of the prohibition on delegation. The most important results of those surveys are presented below with regard to which duties a secretary can or cannot perform according to those surveys: However, it should first of all be recalled that an assistant may not be equated with a secretary, let alone in a case such as the present one, in which the rules agreed between the parties and arbitrators already provided for two secretaries made available by the PCA. The appointment of an ‘assistant’ was not provided for in those Terms of Appointment, nor in the applicable rules of Dutch Arbitration Law (WvRv) or the UNCITRAL Arbitration Rules.

1007. The first column shows the tasks submitted to the respondents asking whether these tasks may be performed by a secretary. The following four columns show the percentages of the positive answers to these questions ‘per survey’. Furthermore, the groups of respondents were always different in size and composition.

	QM/W&C 2012	Y.ICCA 2012/2013 ¹⁶⁹²	BLP 2015	QM/W&C 2015
organising hearings and such ¹⁶⁹³	97%	88.2 / 95.6%	98%	93%
organising the file	-	-	95%	-
drafting the procedural order	72%	60.2 / 71.4%	51%	75%
legal research ¹⁶⁹⁴	43%	68.8 / 85.7%	47%	55%

¹⁶⁸⁹ 2012 International Arbitration Survey: Current and Preferred Practices in the Arbitral Process; Queen Mary College, University of London and White & Case, **Exhibit RF-94**.

¹⁶⁹⁰ Young ICCA Guide on Arbitral Secretaries, 2014, Annex B and C, **Exhibit RF-93**.

¹⁶⁹¹ BLP International Arbitration; Research based report on the use of tribunal secretaries in international commercial arbitration, Survey 2015 (**Exhibit RF-217**; BLP stands for Berwin Leighton Paisner). Queen Mary and White & Case published a new International Arbitration Survey in 2015, which is hereby submitted in part as **Exhibit RF-395**, cover pages, pp. 1-3 and pp. 42-44.

¹⁶⁹² When assessing these results, it is important to note that "secretaries" were overrepresented among the respondents (almost 50%) in the Young ICCA survey. In view of their training to become arbitrator and the nature of their position, they have an interest in the most arduous duties.

¹⁶⁹³ In this case, this was a duty of the PCA Secretariat, not – not even partly – of the assistant Valasek.

¹⁶⁹⁴ In this case, the parties themselves had already submitted the legal material on which they relied with the case documents.

UNOFFICIAL TRANSLATION

This text is an unofficial translation of the Dutch original. In case of any discrepancies, the Dutch original shall prevail.

summarising facts, positions and/or proofs ¹⁶⁹⁵	-	38.7 / 49.5%	33%	-
analysing arguments of pp.	-	38.7 / 49.5%	14%	-
attending the deliberations in chambers	-	17.2 / 72.5%	58%	-
contributing in chambers	9%	5.4 / 16.5%	10%	12%
drafting the material components of the award	11%	- / 31.9% ¹⁶⁹⁶	10%	13%

1008. HVY are making a mockery of these survey results.¹⁶⁹⁷ For example, they point out that a substantial number of respondents did not object to drafting by secretaries. However, they do not mention that this pertains solely to simple procedural orders (deadlines, postponements and such) and to the bare, factual and neutral introduction of the award with the details of the parties involved (et al.) and the Tribunal (et al.) as well as the summary of the course of the proceedings. Indeed, according to the vast majority of those same respondents, the contributions of a secretary may not pertain to disputed factual findings or statements, as these usually support crucial assessments with equally crucial material consequences for the decisions. Likewise, HVY point to the consent of a substantial number of respondents to the presence of a secretary during the deliberations of the tribunal. However, they do not mention that this pertains solely to keeping minutes and, when requested, looking up and handing over documents. Indeed, the vast majority do not want secretaries to participate in the substantive deliberations of arbitrators. Even consultations between a secretary and arbitrators on the merits of the case are considered undesirable by the vast majority.

1009. HVY’s reliance on the purportedly different recommendations (“Best Practices”) of the Young ICCA Guide on Arbitral Secretaries (2014) is also misleading.¹⁶⁹⁸ After all, HVY rely on the survey results and isolated quotes rather than on the actual recommendations and the explanatory notes of Young ICCA. These explanations to the recommendation of

¹⁶⁹⁵ In this case, the parties had already submitted summaries of their assertions and positions to the Arbitrators.

¹⁶⁹⁶ This ‘outlier’ can probably be explained by what has been argued in footnote 1692 and by the vagueness of the question in the Y.ICCA survey. In any event, over 2/3 of these respondents is also against secretaries writing drafts for the substantive decisions.

¹⁶⁹⁷ See SoD, Part I, §§ 615 et seq., SoRej., §§ 355 et seq., Pleading Notes RF, §§ 150 et seq., and SoA, § 796.

¹⁶⁹⁸ See SoD, Part II § 601 and **Exhibits RF-92 and 93**.

article 3 – the “Role of the Arbitral Secretary”- rightly make important reservations that HVY neglect to mention in their reliance on that Guide. However, the explanations to these recommendations – Article 3 on the “Role of the Arbitral Secretary” – rightly make important reservations that HVY neglect to mention in their reliance of that Guide.¹⁶⁹⁹

1010. Paragraph 1 of Article 3 indeed states that a secretary’s role may be more than purely administrative/organisational.¹⁷⁰⁰ However, each of those duties mentioned under (e) through (j) of paragraph 2 and emphasised by HVY is followed by a restrictive interpretation, given the explanation thereof. The “legal research” (under e) merely refers to checking the sources cited by the parties; not to an own legal assessment by a secretary. The “factual research” (under f) merely refers to identifying “key documents” and such for the arbitrators, which documents the arbitrators must – of course – personally verify and evaluate. The summaries of the facts and points in dispute to be drafted by the secretary (under h) are also meant merely to support the arbitrators’ own research; secretaries naturally cannot omit or colour anything of relevance in their memoranda. The explanation furthermore shows that “attending the arbitral tribunal’s deliberations” (under i) merely serves to draft reports, hand over documents and such, and explicitly not “to participate in the deliberations”. Finally, “drafting appropriate parts of the award” (under j) pertains mainly to the “procedural and factual background” and the “parties’ positions”, while acknowledging that even the representation of the facts and positions may in certain circumstances already involve a task that is possibly open to dispute.

1011. This view of the practice confirms the consensus following from the writings of the most authoritative and experienced authors that a secretary may not perform substantive tasks. In particular, a secretary may in any event not draft “substantive decisions” in the awards. The Russian Federation already quoted from these writings extensively in §§ 479 et seq. of its Summons and §§ 605 et seq. and §§ 621 et seq. of its Reply. An anthology of the literature cited in the first instance, supplemented by some new sources, follows an overview of the relevant regulations of a number of arbitration organisations.

¹⁶⁹⁹ See SoR, §§ 594 et seq.

¹⁷⁰⁰ Again: the Russian Federation is not complaining about this. However, there is a fundamental difference between a memorandum or summary with factual and/or legal information, on the one hand, and a (draft) substantive decision in the arbitral award, on the other.

1012. It is once again emphasised here that the Russian Federation does not complain at all about any summaries, draft procedural orders or a draft overview of the course of the proceedings that may have been prepared by the assistant Valasek. This relates exclusively to (i) his predominant authorship of the crucial chapters IX, X and XII of the Final Awards, and (ii) the total lack of transparency beforehand on the part of Arbitrators about this spurious role of their “assistant”.

(b)(iii) *HVY wrongly invokes the absence of a statutory prohibition*

1013. Neither the Dutch Code of Civil Procedure nor the UNCITRAL Arbitration Rules, which govern these Arbitrations, contain any explicit rules about the tasks that a secretary may or may not carry out. In addition, they do not explicitly prevent the appointment of an assistant in addition to a secretary. The simple explanation for this is that these rules do not provide for the phenomenon of a separate assistant (in addition to a secretary), nor do the regulations of the best-known arbitration organisations stated below. However, HVY’s defence¹⁷⁰¹ that a tribunal can “therefore” engage an assistant for the preparation of its *substantive* decisions is preposterous.

1014. To the contrary, to safeguard the ‘*intuitu personae*’ of arbitrators, a formally appointed and regulated secretary may in principle only perform organisational and administrative tasks. The ‘substantive support’ to arbitrators has been clearly defined: a secretary is not allowed to write drafts for the ‘substantive’ decisions, not even if these are signed by the arbitrator(s) afterwards. This follows from, among other things, Article 1026(1), Article 1027(1) and Article 1065(b) and (c) DCCP. See also the Timmerman quote in § 1000 above, which militates in favour of a mandatory, fundamental principle of (regular and arbitral) procedural law. *A fortiori*, therefore, arbitrators may not outsource the preparation of a draft award to an unregulated officer. This is all the more cogent given that Articles 1033 to 1035 DCCP, inclusive, for arbitrators and secretaries equally provide for safeguards regarding their impartiality and independence, resulting in the possibility of an objection request to be ultimately – if necessary – assessed by the regular court. However, the law does not provide such safeguard and sanctions for assistants.

¹⁷⁰¹ See SoD, Part II, §§ 609 et seq., SoRej., §§ 354-360 et seq., Pleading Notes HVY, §§ 150 et seq., and SoA, §§ 796 et seq.

1015. HVY's argument that a tribunal will be able to give an award faster and in a cheaper way by using the help of a secretary is entirely true, but, when applied to the *substantive* tasks of arbitrators, undermines the very foundations of the '*intuitu personae*' requirement. The costs and pace of the proceedings are naturally key focus points for the parties, but they primarily chose for a decision by skilled and experienced arbitrators, instead of a 'junior'. In HVY's purely "economic" approach, arbitrators could even prefer to have their decisions prepared by an intelligent "working student". The Dutch Civil of Civil Procedure and the Rules do not contain any prohibition on such additional cheap assistance either. While Article 1036 DCCP and Article 15 UNCITRAL Rules allow arbitrators a large degree of discretion in structuring the proceedings, but such in subordination to the agreement between the parties and the mandatory procedural law of the *lex arbitri*. The 'agreement' entails that arbitrators have undertaken vis-à-vis the parties to adjudicate the case themselves; the mandatory law entails that arbitrators may not delegate this task either formally or substantively.

(b)(iv) Transparency of the arbitrators and prior consent of the parties as requirements

1016. The legal literature quoted § 1018 below therefore contains, in addition to several formal rules and recommendations of arbitration institutes just cited in § 1017 and the findings of the survey referred to above in § 1007, some clear conditions and limits to entrusting secretaries – and *a fortiori* to assistants – with anything that comes close to "substantive" activities. The main, generally endorsed condition is that the tribunal must be transparent towards the parties about such intention *in advance*, and must obtain their "informed consent" in this respect. According to the Young ICCA and BLP surveys, this requirement is endorsed by nearly 80% of the respondents.- It must also be considered in that respect that approximately 90% of the respondents in any case reject any "substantive" involvement by a secretary in decisions.

1017. First of all, the following quotes from arrangements giving substance to the role of a secretary serve to substantiate the arbitrators' duty to take account of the conditions and limits referred to above. In this context, account must again be taken of the circumstances that (i) none of the known sources discusses the figure of an assistant in addition to a

secretary,¹⁷⁰² (ii) that, in this case, the Terms of Appointment laid down by the Tribunal and parties – that make no mention of the position of an ‘assistant’ – only provide for assigning the entire administration and organisation to the specialised PCA Secretariat, and (iii) that when Mr Valasek was introduced as an ‘assistant’ by Chairman Fortier, not even the slightest hint was given that Mr Valasek would ever perform any substantive task, nor was this indicated at any later occasions. For more details on points (ii) and (iii) see §§ 1019 et seq. below, in which the Russian Federation also refutes HVY’s reliance on forfeiture of rights.

(b)(v) *Quotes from regulations and recommendations of arbitration institutes and the like.*¹⁷⁰³

- Note from the Secretariat of the ICC Court Concerning the Appointment of Administrative Secretaries by Arbitral Tribunals 1995:

“The duties of the administrative secretary must be strictly limited to administrative tasks (...) Such person must not influence in any manner whatsoever the decisions of the Arbitral Tribunal.

In particular, the administrative secretary must not assume the functions of an arbitrator, notably by becoming involved in the decision-making process of the Tribunal or expressing opinions or conclusions with respect to the issues in dispute.” (Exhibit RF-92)

- F.J.M. De Ly, Kroniek, TvA 2012/84, regarding new ICC Note:

“On 1 August 2012, the ICC published a new memorandum in this context concerning the practice to be used by the ICC Court and the ICC Secretariat with regard to the appointment, tasks and remuneration of administrative

¹⁷⁰² An exception applies to ICSID proceedings in which arbitrators sometimes have their ‘own assistant’, in addition to the ‘secretariat’ from the ICSID organisation itself. A publication of the International Centre for Settlement of Investment Disputes dated 2014 states the following in this regard: "*In some cases the Tribunal or Tribunal President also wish to retain an assistant for additional support to the Tribunal. Such an assistant may only be appointed with the prior consent of both parties to the dispute. The parties should be provided with the assistant’s curriculum vitae, proposed tasks to be performed (...). Tribunal assistants are subject to the same confidentiality obligations as the Member of the Tribunal and also required to sign a declaration of independence and impartiality.*" (emphasis added)

¹⁷⁰³ The emphasis in the quotes below has been added by counsel, in particular to highlight the connected requirements of transparency and ‘informed consent’ *in advance*. All texts below in any case emphasise that secretaries may not prepare or otherwise influence the substantive decisions. It is recalled (§ 970 above) that Chairman Fortier’s appointment of Valasek as assistant has been forced upon the parties as an accomplished fact based on a non-substantive job description, while the parties were never informed of an expansion with substantive tasks at any later stage either, let alone that they were ever asked for their prior permission.

secretaries of tribunals operating under the ICC Arbitration Rules. [...] This still involves administrative secretaries, so they are only allowed to perform supporting activities of an administrative nature. These organisational and administrative activities are listed and also include: attending the deliberations in chambers, performing legal research and research of a similar nature, checking drafts of procedural decisions and awards and correcting typographic, grammatical or calculation errors. Decisions or other essential tasks of arbitrators are still not to be delegated to secretaries, and memoranda by secretaries may not result in arbitrators not personally assessing the case and writing awards. [...] The major changes involve the tightening of the appointment procedure: this still requires the parties' approval [...] It therefore would have been preferable if the tribunal's statement to the parties had more clearly indicated precisely what the secretary's tasks involved, such to exercise more transparency. Also apart from the aforesaid memorandum, and in arbitrations other than ICC arbitrations as well, it is most certainly recommended to clearly communicate with the parties about the exact activities of the secretary.”

On October 30, 2017, the ICC published a comprehensive set of recommendations: “Note to the Parties and Arbitral Tribunals on the Conduct of the Arbitration under the ICC Rules of Arbitration”. Chapter XVII deals with “*Administrative Secretaries*”. The tenor of these recommendations has not changed: “148. *The arbitral tribunal shall make clear to the parties that (...) an Administrative Secretary shall not be appointed if a party has raised an objection.*” After listing in No. 150 some “*organisational and administrative tasks*” No. 151 provides: “*Under no circumstances may the arbitral tribunal delegate decision-making functions to an Administrative Secretary. Nor should the arbitral tribunal rely on the Administrative Secretary to perform any essential duties of an arbitrator.*”

- UNCITRAL Notes on Organizing Arbitral Proceedings 2012, § 27:¹⁷⁰⁴

“To the extent the tasks of the secretary are purely organizational (e.g. obtaining meeting rooms and providing or coordinating secretarial services), this is usually not controversial. Differences in views, however, may arise if the tasks include legal research and other professional assistance to the arbitral tribunal (...). Views or expectations may differ especially where a task of the secretary is similar to professional functions of the arbitrators. Such a role of the secretary is in the view of some commentators inappropriate or is appropriate only under certain conditions, such as that the parties agree thereto. However, it is typically recognized that it is important to ensure that the secretary does not perform any decision-making function of the arbitral tribunal.” (Exhibit RF-91)

¹⁷⁰⁴ These ‘Notes’ are not formally part of the UNCITRAL Arbitration Rules applicable in this case, but do serve to offer guidelines issued by the same UN organisation for arbitrations to be organised under these ‘Rules’.

- The revision of these UNCITRAL Notes of 2015 provides the following under the heading “Secretary to arbitral tribunal”:

“36 (...) Secretaries may provide purely organizational support, such as making reservations for hearing and meeting rooms and providing or coordinating administrative services. Some arbitral tribunals wish to have secretaries carry out more substantive functions including legal research and other professional assistance, such as preparing a summary of the facts or the procedural history of the arbitral proceedings, collecting or summarizing case law or published commentaries on legal issues defined by the arbitral tribunal, and preparing draft procedural decisions. (...) In any event, secretaries should not exercise the decision-making function of the arbitral tribunal. (...)”

38. If the arbitral tribunal wishes to appoint a secretary, it would normally disclose this fact to the parties, along with the identity of the proposed secretary, the nature of the tasks to be performed by the secretary, and the amount and source of any proposed remuneration. The parties may wish to agree on the role and practices to be adopted in respect of the secretaries, as well as on the financial conditions applicable to their services.”

- Guidelines for use of clerks and tribunal secretaries in arbitrations, JAMS International:

“• The Tribunal’s use of Clerks or Secretaries must be approved by the parties after disclosure. (...)”

• The arbitrator’s disclosure regarding the use of a Clerk or Secretary will state the types of tasks assigned to the Clerk or Secretary, e.g., research and/or drafting. At no time can a Clerk or Secretary engage in deliberations or decision-making on behalf of an arbitrator or tribunal (...).”

- Young ICCA Guide on Arbitral Secretaries (2014):¹⁷⁰⁵

“Article 1. General Principles on the Appointment and Use of Arbitral Secretaries

[...]

(4) It shall be the responsibility of each arbitrator not to delegate any part of his or her personal mandate to any other person, including an arbitral secretary.”

Explanation to Article 1(4):

¹⁷⁰⁵ With regard to Article 3 ‘Role of the Arbitral Secretary’, see § 1010 above, with emphasis in the accompanying explanation of the strict limits imposed on any more substantive tasks.

UNOFFICIAL TRANSLATION

This text is an unofficial translation of the Dutch original. In case of any discrepancies, the Dutch original shall prevail.

“The most common reason for objecting to the use of arbitral secretaries is that the mandate of the arbitrator is *intuitu personae* (“according to the person”) and that any use of arbitral secretaries that goes beyond the purely administrative risks derogating from the arbitrator’s personal responsibility. Indeed, of those respondents who opposed the use of arbitral secretaries in the 2012 Survey, 80.0% gave as the principal reason for their objection the potential for the ‘[d]erogation from an arbitrator’s responsibilities’, when given the choice between this option and ‘costs’. Any arbitrator who appoints an arbitral secretary must, therefore, do so appropriately and with great care not to delegate any part of his or her decision-making in a way that would dilute the arbitrator’s mandate. (...)” (Exhibit RF-93)

- ACICA (Australia) Guideline on the use of tribunal secretaries (2017):

“3. An arbitral tribunal may appoint or remove a tribunal secretary at any stage of the arbitration upon consultation with the parties. (...)”

5. The arbitral tribunal shall only proceed with the appointment of the proposed secretary upon the agreement of the parties. Throughout the course of the arbitration, any changes to tribunal secretary arrangements or terms of appointment may only be made with the agreement of the parties.

10. The tribunal secretary shall at all times act under the direction and close supervision of the arbitral tribunal. The arbitral tribunal shall at all times be responsible for the secretary’s conduct in connection with the arbitration.”

11. Unless the parties otherwise agree, the tribunal secretary may:

- a) provide administrative assistance;
- b) summarise and/or research factual and legal issues in the record; and
- c) prepare drafts of procedural orders and non-substantive parts of awards.

12. The tribunal secretary must not perform any decision-making functions.”

- LCIA (United Kingdom) Notes for Arbitrators (2017):

“68. (...) in no circumstances may an Arbitral Tribunal delegate its fundamental decision-making function.

69. Assistance provided by a tribunal secretary does not relieve any member of an Arbitral Tribunal from their personal responsibility to ensure that all tasks are performed to the standard required by the LCIA Rules and these notes. All tasks carried out by a tribunal secretary are carried out on behalf of the Arbitral Tribunal, and must be carried out under the supervision of the Arbitral Tribunal.

71. An Arbitral Tribunal must inform the parties of the tasks that it proposes the tribunal secretary be entitled to carry out. While the LCIA does not endorse any particular tasks as necessarily being appropriate for a tribunal secretary to carry out, an Arbitral Tribunal may wish to propose any or all of the following:

a) that the tribunal secretary carries out administrative tasks, such as communicating on behalf of the Arbitral Tribunal, organising documents, proofreading, organising procedural matters, and dealing with matters relating to invoices;

b) that the tribunal secretary attends hearings, meetings, and deliberations; and

c) the extent, if any, to which the tribunal secretary carries out substantive tasks, such as summarising submissions, reviewing authorities, and preparing first drafts of awards, or sections of awards, and procedural orders,

provided always that paragraphs 68 and 69 above are fully complied with and that such tasks are carried out in accordance with the Arbitral Tribunal's specific instructions.

74. An Arbitral Tribunal can only obtain assistance from a tribunal secretary once the tribunal secretary has been approved by the parties. A tribunal secretary is approved once:

a) the parties have agreed the tasks that may be carried out by the tribunal secretary (...).”

- The Finland Chamber of Commerce's "Guidelines for Using a Secretary in FCC Arbitration":

“The secretary may check the accuracy of facts, figures and calculations in the arbitral award, but the arbitral tribunal retains the responsibility for the correctness of the arbitral award. The secretary may assist the arbitral tribunal in researching legal or technical matters as well as in obtaining background material.

The secretary acts as a technical assistant to the arbitral tribunal, but has no independent decision-making power. The secretary may neither participate in deliberations of the arbitral tribunal nor in decision-making and may not sign the arbitral award.

The arbitral tribunal decides the structure of the arbitral award. The secretary does not participate in drafting of the arbitral award or in decision-making and may not influence the content of the arbitral award in any other way. (...).”

- HKIA (Hong Kong) Guidelines on the use of a secretary to the arbitral tribunal (2014):

UNOFFICIAL TRANSLATION

This text is an unofficial translation of the Dutch original. In case of any discrepancies, the Dutch original shall prevail.

“2.3 Before appointing a secretary, an arbitral tribunal shall inform the parties of its proposal to do so. For this purpose, the arbitral tribunal shall disclose the identity of the proposed secretary and send to the parties the following documents for their comments, unless the parties agree otherwise:

- (a) the proposed secretary’s curriculum vitae;
- (b) the Declaration [with regard to availability, impartiality and independence]; and
- (c) a copy of these Guidelines.

3.2 The arbitral tribunal shall not delegate any decision-making functions to a tribunal secretary, or rely on a tribunal secretary to perform any essential duties of the tribunal.

3.3 Unless the arbitral tribunal directs otherwise, a tribunal secretary may perform organisational and administrative tasks including, but not limited to, the following:

- (a) transmitting documents and communications on behalf of the arbitral tribunal;
- (b) organising and maintaining the arbitral tribunal’s files and locating documents;
- (c) organising hearings and meetings;
- (d) attending hearings and meetings; taking notes or minutes or keeping time;
- (e) proofreading and checking citations, dates and cross-references in procedural orders, directions, and awards, as well as correcting typographical, grammatical or calculation errors;
- (f) preparing, collecting and transmitting the arbitral tribunal’s invoices; and
- (g) handling all other organisational and administrative matters which do not fall into the scope of responsibilities of HKIAC.

3.4 Unless the parties agree or the arbitral tribunal directs otherwise, a tribunal secretary may provide the following assistance to the arbitral tribunal, provided that the arbitral tribunal ensures that the secretary does not perform any decision-making function or otherwise influence the arbitral tribunal’s decisions in any manner:

- (a) conducting legal or similar research; collecting case law or published commentaries on legal issues defined by the arbitral tribunal; checking on legal authorities cited by the parties to ensure that they are the latest authorities on the subject matter of the parties’ submissions;

- (b) researching discrete questions relating to factual evidence and witness testimony;
- (c) preparing summaries from case law and publications as well as producing memoranda summarising the parties' respective submissions and evidence;
- (d) locating and assembling relevant factual materials from the records as instructed by the arbitral tribunal;
- (e) attending the arbitral tribunal's deliberations and taking notes; and
- (f) preparing drafts of non-substantive letters for the arbitral tribunal and non-substantive parts of the tribunal's orders, decisions and awards (such as procedural histories and chronologies of events).

3.6 A request by the arbitral tribunal to a tribunal secretary to prepare notes, memoranda or drafts shall in no circumstances release the arbitral tribunal from its duty personally to review the relevant files and materials, and to draft any substantive parts of its orders, decisions and awards."

- CEPANI (Belgium), Guidelines for the secretary to the Arbitral tribunal (2007):

"2.3. Prior to appointing a secretary to the arbitral tribunal, the arbitral tribunal must draw up a specific and detailed description of the secretary's role.

This description shall be communicated, for information purposes, to the parties and to the CEPANI secretariat.

2.4. The secretary to the arbitral tribunal's primary tasks shall be as follows: making the material and organisational arrangements for arbitration hearings; taking the minutes of these hearings on behalf of the arbitral tribunal; conducting legal research on behalf of the arbitral tribunal; and preparing summaries of the cases.

2.5. The secretary to the arbitral tribunal is not an arbitrator. As such, he/she may not be involved in the deliberations of the arbitral tribunal or be entrusted with drafting the arbitral award. (...)"

- ICSID Arbitration Rules:

"Rule 15: (1) The deliberations of the Tribunal shall take place in secret (...)
(2) Only members of the Tribunal shall take part in its deliberations (...)."

1018. The *conclusion* with regard to all these quotations is that all known rules and guidelines¹⁷⁰⁶ of arbitration organisations emphasise that secretaries should in any case not be charged

¹⁷⁰⁶ Regulations or guidelines of a different nature have not been found.

with the drafting of decisions on substantive issues and that many of these documents provide that the use of a secretary by a tribunal requires the prior consent of the parties, not only with regard to his/her person and remuneration, but also with regard to his/her tasks.

(b)(vi) Quotes from the legal literature on international arbitration

- Constantine Partasides, 'The Fourth Arbitrator? The Role of Secretaries to Tribunals in International Arbitration', 2002, p. 147:

"It is axiomatic to say of an arbitrator's mission that it is 'intuitu personae'. A party's choice of arbitrator is, of essence, personal. And so is the chosen arbitrator's mandate. In accepting appointment, an arbitrator necessarily accepts a duty not to delegate that mandate."

Idem: "I propose two rules as minimum restraints on the activities of secretaries aimed at removing the risk of an arbitrator being improperly influenced by a secretary's work (...). An arbitrator should never rely on a secretary's work to the exclusion of his own review of the file (...). An arbitrator should restrict a secretary's role in the drafting of awards." (Exhibit RF-88)

- Teresa Giovannini, 'Le Nouveau Reglement suisse d'arbitrage international', Gazette du Palais, 2004, p. 29 (**Exhibit RF-396**):

"(...) it seems important to stress that the secretary is not a member of the tribunal: every measure should be taken to ensure that the opinions of the tribunal are not in the slightest way influenced by the secretary."

- Thomas Clay, 'Le secretaire arbitral', Revue de l'Arbitrage, 2005, Issue 4, p. 953-955 (unofficial translation) (**Exhibit RF-397**):

"Therefore, it seems unacceptable that the arbitral secretary takes part in the deliberations or writes a procedural order or arbitration award him or herself, even partially. [...] The deliberation is a matter of sharing and reflection among those who decide the matter, and it is prohibited for third parties to be present. [...] The secretary of the tribunal must abstain from exercising any influence whatsoever on the outcome of the case. This is also a concern that the ICC has often pointed out, including in the note received by each arbitrator at the start of the proceedings. Handing down a ruling is the task of the arbitrators and no one else. [...] The arbitrator must not accept an assignment if he or she is unable to accomplish this. He or she is even required to double check that he or she has sufficient time to fulfil the obligations. If that is not the case, it is the arbitrator's responsibility to reject an assignment rather than to delegate it."

- Joint Report of the International Commercial Disputes Committee and the Committee of Arbitration of the New York City Bar Association, The American Review of International Arbitration, 2006/Vol. 17, No. 4, p. 575 et seq., p. 586-591 (**Exhibit RF-398**):

“(…) Simply stated, parties involved in arbitration rely on the notion that their chosen arbitrator(s) will personally review and rule on their claims. The role of a secretary potentially challenges this assumption. It can reasonably be inferred that the greater a secretary’s involvement in the non-administrative tasks of the tribunal, the more likely he or she may affect the decision-making process of the tribunal. However, as Alan Redfern and Martin Hunter write, ‘[T]he task [of the secretary] is to assist the arbitral tribunal, not to usurp its function.’ (…)

Ultimately, the integrity of the arbitral process is better safeguarded by preserving the parties’ right to participate in the appointment of the secretary, including the determination of the secretary’s duties. (…)

There is concern that a secretary permitted substantial involvement may exercise undue influence over the arbitral tribunal and, as a result, affect the disposition. This concern is best addressed by disclosure, transparency and informed consent of the parties.”

- G. Keutgen and G.A. Dal, ‘L’Arbitrage et Droit Belge et international’, 2006, p. 228-229 (unofficial translation) (**Exhibit RF-399**):

“229. By accepting a mandate, the arbitrator undertakes to resolve the dispute personally. Indeed, the mandate is personal, because the appointment takes place in view of personal qualifications, intuitu personae. From this emerges that no delegation of tasks may take place (…).

230. This rule also applies in case a secretary of the tribunal has been appointed (…). Secretaries may be instructed to report on arbitration hearings, to organise the flow of documents, to conduct legal inquiries for the deliberations of the arbitrators or to prepare documents for the discussion on the award to take place between the arbitrators.

A secretary may only be appointed with the agreement of the parties (…). It is up to the parties and the arbitrators to decide at the start of the proceedings the tasks with which the secretary can be entrusted.”

- Franz Schwarz and Christian Konrad, ‘The Vienna Rules: A commentary on International Arbitration in Austria, 2009, p.119-175 (**Exhibit RF-400**):

“(…) the parties appoint an arbitrator because of his or her individual qualifications. The arbitrator is (therefore) not allowed to delegate his mandate to decide the parties’ legal dispute, the arbitrator’s mission is considered intuitu personae. With the increasing use of secretaries concerns grow,

therefore, that their involvement contradicts the principle that the arbitrator has to perform his task in person. This has led to motions to dismiss the arbitrator; or to the ICC Court requesting a tribunal to replace its secretary (who was himself known as an arbitrator).”

- Jeff Waincymer, Procedure and Evidence in International Arbitration (Kluwer Law International 2012), 6.8 The role of a Secretary to the Tribunal, p. 444-445:

“(…) A secretary should only be appointed with the agreement of the parties. The parties should be entitled to approve the person nominated. (...) and have a clear understanding of the limits of the duties of the secretary (...) The secretarial assistant may also conduct legal research and summarise evidentiary materials to help point tribunal members towards the areas where key deliberations are required, although the tribunal must still exercise independent and adequate judgment at all times. Care should be taken to ensure that the tribunal does not improperly delegate the decision as to what is or is not important if evidentiary materials are to be mustered by a secretary.

It is accepted that it is permissible for a secretary or arbitrator assistant to draft the introductory portion of an award such as those parts outlining the identities of the parties and counsel and if included, the procedural history and a brief outline of the none-controversial facts. (...)

The essential parts of the award should be drafted by the tribunal and should not be delegated to a secretary or any other person. More contentious is the question of whether a secretary or other assistant can draft recommendations as to parts of the award for tribunal evaluation. It is commonly suggested that this is inappropriate.”

- James Menz, ‘Miss Money Penny vs. the Fourth Musketeer: The Role of Arbitral ‘Secretaries’, Kluwer Arbitration Blog, 9 July 2013 (**Exhibit RF-401**):

“(…) It is up to the parties and the arbitral tribunal to determine the right level of involvement. This decision should be guided by openness and consent (...) The best check against abuse is not prohibition, but additional transparency and quality control mechanisms (...).”

- Marcel Fontaine, ‘L’arbitre et ses collaborateurs’, 2013, no. 36 (unofficial translation from French) (**Exhibit RF-402**):

“If a tribunal desires assistance with regard to certain tasks, we consider it in any event essential that the parties are informed in this regard, and even that their consent is obtained accordingly (...). In addition, in order to ensure that this consent was given intentionally, the scope of the tasks to be entrusted to the secretary should be specified.”

- Gary Born, *International Commercial Arbitration* 2014, p. 2000 and 2043:
 - “a central premise of the role of the secretary [is] that he or she may not assume the tribunal’s (or an arbitrator’s) functions and may not influence the tribunal’s decision.”
 - “[I]t is widely agreed that the secretary must not assume the tribunal’s functions of hearing the evidence, evaluating the legal arguments, deciding the case or preparing a reasoned award.” (Exhibit RF-90)

- Zachary Douglas, ‘The Secretary to the Arbitral Tribunal’, in ‘Inside the Black Box: How Arbitral Tribunals Operate and Reach Their Decisions’, ASA Special Series No. 42, 2014, p. 87-88 (**Exhibit RF-403**):
 - “The best argument for challenging the award – and it comes back to the true part of the story – is that the role of the secretary was not disclosed to the parties. The best basis for this challenge would be that if this practice of allowing secretaries to draft awards is legitimate then why was it done in secret? Why did the parties not know about it? Why was it not reflected in the award? That is the crux of the point I want to make. (...) there are real dangers posed by the lack of transparency. The bottom line is that parties need information about how a tribunal proposes to produce its award in order to make an informed choice at the outset of the proceedings.”

- Klaus Peter Berger, Part III, 27th Scenario: “Deliberation of the tribunal and Rendering of the Award”, *Private Dispute Resolution in International Business, Negotiation, Mediation, Arbitration* (Third Edition), Third Revised Edition, Kluwer Law International 2015, p. 613-642 (**Exhibit RF-404**):

“27-9 (...) In light of the increasing procedural and factual complexity of international arbitration (No. 16-7), the use of tribunal secretaries belongs to the modern reality of international arbitration practice. (...) The tasks of such secretaries comprise the organization of the often voluminous files, general administrative matters such as the reservation and setting up of hearing and break-out rooms, the function of serving as an intermediary between the arbitral tribunal and the institution administering the arbitration and other administrative tasks, leaving the arbitrators with more time to devote their attention and energies to the resolution of the procedural and substantive matters at issue. (...) However, there are also risks involved in the use of secretaries. These risks relate primarily to the transparency of the process of appointing them and the dangers of tribunal secretaries becoming involved in the actual decision-making by the arbitral tribunal. (...)

27-11 (...) Because they are not members of the arbitral tribunal, they do not possess decision-making power. This power is reserved exclusively for the arbitrator(s). Their mandate is *intuitu personae*, i.e. it must be performed by

the arbitrators themselves. Arbitrators may not delegate the performance of that strictly personal undertaking owed to the parties to another person, including a tribunal secretary. Therefore, tribunal secretaries may not assume the function of what has commonly been called a ‘fourth arbitrator’. (...)

27.17 (...) Admittedly, the task of writing the award, including the reasons for the tribunal’s decision and the operative part, is a time-consuming process. However, international arbitrators are appointed and are being remunerated not only for conducting the arbitration but also for writing the award which contains the tribunal’s decision of the dispute. If the process of drafting the full award is shifted to the secretary, there is an inherent danger that the chairman, who has entrusted the secretary with that task, will not reserve enough time for the necessary intense scrutiny of the secretary’s draft. When parties nominate their arbitrators, however, they expect – and are entitled to expect – that the arbitrators will do the work themselves. For many, if not the majority of users of arbitration, it is difficult to distinguish ‘writing’ the decision from ‘making’ the decision, since it is only through writing, and in doing so, choosing between different ways of expressing one’s views, that one can really make sure that one has not committed logical and other errors when reaching a decision. This means that writing the award is an inextricable part of the tribunal’s highly personal decision-making duty owed to the parties. (...)

27-19 As a general rule, the drafting of the substantive parts of the final award, which include its operative part, must be reserved for the arbitral tribunal. It is particularly in this substantive section where writing one’s own text instead of reading the text prepared by someone else remains the ultimate means of intellectual control of the tribunal’s decision of the dispute as the essential tool for safeguarding the proper performance of the arbitrators’ personal decision-making duty owed to the parties that have appointed them, thereby preserving the integrity of the arbitral process as such. (...)”

- Rémy Gerbay, Lisa Richman, et al., “Arbitrating under the 2014 LCIA Rules: A User’s Guide”, Kluwer Law International 2015, p. 371-378 (**Exhibit RF-405**):

“(...) some less scrupulous arbitrators delegate to their administrative secretaries duties which are not merely logistical but relate to the overall adjudicative mission of the Tribunal. This constitutes improper delegation of responsibility when it is done without the parties’ consent.”

(b)(vii) *No transparency, no estoppel*

1019. HVY put forward a defence against the Russian Federation’s reliance on the impermissible delegation by the Tribunal of the obligations resting on the Arbitrators personally to their assistant Valasek, *inter alia*, with a reliance on Article 1065(4) DCCP.¹⁷⁰⁷ The Russian

¹⁷⁰⁷ For this defence, see SoD, Part I, §§ 175-177 and SoD, Part II §§ 619-630; SoRej., §§ 371-373; SoA, § 792. Striking, and perhaps Freudian, is that HVY in this context also rely on Article 1064(1)(c) and (4) and Article 1054(4) DCCP, which provisions either do not exist, or do not concern estoppel.

Federation allegedly failed to protest against said delegation at that time, even though, *according to HVY*, the Russian Federation already became aware of this delegation during the course of the proceedings (or at least should have been aware thereof if it had exercised sufficient caution). According to HVY, in the absence of such timely protest, the Russian Federation allegedly forfeited its rights to a reliance on ‘violation of the mandate’ within the meaning of Article 1065 (1) (c) DCCP on the basis of paragraph 4 of the same provision.

1020. For its refutation HVY’s defence based on estoppel, the Russian Federation first of all makes reference to its Reply §§ 564-588. The argument should be deemed integrally inserted here. For the Court of Appeal’s convenience, what is stated below builds on this argument and provides a concise overview of this debate. Insofar as HVY would also like to argue that the Russian Federation’s right to rely on the ground for setting aside contained in Article 1065(1)(b) DCCP¹⁷⁰⁸ has been forfeited on the basis of Article 1065(3) DCCP in conjunction with Article 1052(3) DCCP, this reliance on estoppel fails on the same grounds as adduced in the Statement of Reply and briefly summarised below.

1021. Before the Final Awards, the Russian Federation was unaware of the unauthorised delegation of substantive tasks to Valasek. Moreover – although mere ‘normative knowledge’ may not be taken into account in this regard – it was not obliged to have been aware of this before taking note of the Final Awards. It could only have been aware of this after receiving the subsequent correspondence between its lawyers and the PCA Secretariat.¹⁷⁰⁹ To prevent any misunderstanding, the Russian Federation adds to this that to the extent that in these proceedings governed by the ‘former’ Arbitration Act, Article 1048(a) DCCP of the Arbitration Act 2015 could be anticipated – which the Russian Federation disputes with regard to this point of dispute – such reliance on estoppel by HVY must likewise fail on the same grounds again put forward below with regard to Article 1065(3) and (4) DCCP.

1022. The estoppel criterion of Article 1065(4) (in conjunction with paragraph 1, under c) DCCP provides that a reliance on violation of the mandate “*(can)not result in setting aside if the party that adduces this [ground] participated in the proceedings without relying on this*

¹⁷⁰⁸ Read: the composition of the tribunal was in violation of the rules applicable in that respect, because Valasek *de facto* acted as a fourth arbitrator.

¹⁷⁰⁹ See, *inter alia*, §§ 973 and 978-980 above.

*violation, even though it was aware*¹⁷¹⁰ *that the tribunal did not comply with its mandate.”*

The Supreme Court further elaborated on this criterion in its ‘AREB/AMEG’ ruling of 23 April 2010, which was published and annotated by Tjittes in *JBPR* 2010/46 and by Snijders in *NJ* 2011/475. In this context, legal grounds 3.4.2 and 3.5.3-3.5.4 are particularly important.

1023. In ground 3.4.2, the Supreme Court held that the defendant in the setting aside proceedings must make a specific and substantiated reliance on estoppel, even though, according to the Supreme Court in ground 3.5.3, the obligation to furnish facts and the burden of proof concerning the absence of estoppel are borne by the party that claims that the arbitral award be set aside.
1024. In this case, *after* and to the extent that HVY had put forwarded a reasoned defence based on estoppel, the Russian Federation had consequently to argue and – in the event that this argument is disputed with reasons – prove that it was not aware of the Tribunal’s violation of the mandate, as argued by the Russian Federation, in such time that it was still able to protest against it in the arbitration. Indeed, in ground 3.5.4, the Supreme Court considered that the defence based on estoppel “*cannot be applied if the party that claims the setting aside of the arbitral award [on this ground] first became aware of this by taking note of the arbitral award.*” In this ruling, the Supreme Court explicitly confined itself, as much as three times, to seeking harmonisation with the ‘subjective’ statutory criterion of “*awareness*”. This means it did not anticipate the criterion of the new Article 1048a DCCP (“*as soon as it knows or should reasonably know*”).
1025. Snijders emphasises in his *NJ* note (under 4) – rightfully so according to the Russian Federation – that here there is only room for a very limited form of ‘objectified knowledge’ and that, in particular, no active investigation by the party invoking the violation of the mandate may be required to this end.¹⁷¹¹ As long as such a violation is not apparent from sufficiently specific statements made at the hearing or in the procedural documents, or from direct observation, there is no ‘awareness’ within the meaning of the law. HVY seem to agree with this, as they explicitly limit their reliance on estoppel in SoA, § 792 to the statement that “*at the time of the Arbitrations, the Russian Federation was aware of Mr*

¹⁷¹⁰ Emphasis added.

¹⁷¹¹ ‘Objective knowledge’ should be taken to mean information that under the given circumstances is undeniably ‘deemed known’, even if the ‘subjective knowledge’ of this is difficult to prove.

Valasek's involvement as well as the extent of his involvement. It could have protested against this, but failed to do so."

1026. For the sake of clarity, the Russian Federation – like Snijders – disagrees with the suggestion in the comment of Tjittes¹⁷¹² that the Supreme Court also takes the term “aware” in grounds 3.5.3-3.5.4 of the *AREB/AMEG* ruling to mean ‘normative’ awareness, based on ‘attribution’ of knowledge acquired after hypothetical examination. Incidentally, the Russian Federation would not object to such a ‘normative’ assessment – however incorrect it would be – for the simple reason that it could not possibly have been aware of the unauthorised nature and extent of the delegation by the Tribunal of its substantive tasks to its assistant Valasek. In the following paragraphs, the Russian Federation will prove this in conformity with the burden of proof it bears (see § 1023 above).

1027. The only reference points for this (*rebuttal*) evidence are of course contained in the assertions by which HVY argue that the Russian Federation did have ‘awareness’ prior to the Final Awards of the nature and scope of Valasek’s too-far reaching involvement in the forming of substantive opinions of the Tribunal. This defence of HVY is highly peculiar, given that they argue at the same time that there were no legal objections against the cooperation between the Tribunal and its assistant, since, according to HVY¹⁷¹³, arbitrators already take sufficient final responsibility for their awards by signing them, regardless of who authored the award. It therefore remains a mystery exactly against what, and exactly at what time, the Russian Federation could and should have protested prior to the end of the Arbitrations *according to HVY*.

1028. HVY nevertheless invoke six events and/or circumstances for their assertion that the Russian Federation was already “aware” of Valasek’s too-far reaching contributions to the forming of substantive opinions by the Tribunal. These six ‘arguments’ are discussed in what follows. It should be stated first and foremost that none of those six ‘arguments’ even come close to a proposal made by the Tribunal to the parties to allow its assistant to make

¹⁷¹² Tjittes bases that statement on a comparison with the rulings *Nordström/Van Nievelt* (NJ 1994/765) and *Waterschappen/Milieutech* (NJ 2004/569). Not only were said rulings about an entirely different subject matter (reproach of bias on the part of an arbitrator and reproach of deceit in the proceedings, respectively), but moreover the Supreme Court would clearly have repeated those criteria from 1994 and 2003, respectively, in 2010 if it considered those criteria relevant in the framework of Article 1065(4) DCCP.

¹⁷¹³ See, *inter alia*, SoRej., § 355, and SoA, § 797.

substantive contributions to the forming of opinions and a request for permission to that effect from the parties. Therefore, HVY's estoppel defence is based on the – incorrect – *petitio principii* that the appointment of an assistant allegedly implies that this officer should be allowed to conceive large sections of the substantive decisions about important points in dispute, even if that was neither announced nor requested. As becomes clear from the aforementioned overview of arbitration rules and arbitration literature cited in §§ 1017-1018, there are no grounds for that assumption made by HVY. In fact, the contrary arises from the principal rule in such matters.

1029. Set out below is a summary of the six grounds invoked by HVY for estoppel (forfeiture of rights) in respect of a reliance on Article 1065(1)(b) and Article 1065(1)(c) DCCP

- (a) The oral introduction of Valasek appointment as assistant by Chairman Fortier during the first procedural hearing on 31 October 2005.
- (b) The confirmation by Chairman Fortier of this appointment in an e-mail of 02 November 2005, with the CV of "Martin" attached and Fortier's statement that his colleague is impartial and independent.
- (c) The interim settlement by the PCA Secretariat dated 29 January 2008 for the period up to and including December 2007 and the settlement dated 9 February for the calendar year 2008.
- (d) The permission requested by the PCA Secretariat on behalf of the Tribunal, in a letter dated 26 January 2012, to increase Valasek's fee from €250 to €325 per hour (the Arbitrators' hourly fees were increased from €750 to €850).
- (e) The fact that Valasek attended all hearings – except the first one – and that his name and position were stated on all documents sent by/on behalf of the Tribunal, including the hearing reports, procedural orders and Interim Awards.
- (f) The compliments and words of thanks expressed by Chairman Fortier and by a lawyer for the Russian Federation, respectively, at the last session of the first phase and at the last session of the second phase of the Arbitration, respectively.

Re (a) and (b): Valasek's introduction and appointment

1030. The circumstances mentioned above under (a) and (b) do not even warrant the qualification of 'argument'. At the first hearing of 31 October 2005 the parties, according to the transcript (see § 5 above) were confronted with the *fait accompli* that Chairman Fortier had already appointed his colleague. This position was not part of the Terms of Appointment that were approved at that time, nor did the Tribunal consult the parties about this before or after. The same is true for the confirmation of the appointment two days later. HVY furthermore fail to mention any other occasion at which the Tribunal *did* make explicit statements about substantive task components of Valasek's job, let alone that the parties were asked to grant their approval.

1031. All the parties ever heard was that Valasek was to provide "*assistance in the conduct of the case*" and was available for communication if the Chairman could not be reached himself due to his busy schedule and many travels.¹⁷¹⁴ The Russian Federation construed this, and could - or even should - construe this as a purely logistical position. It was not up to the parties to start a discussion about the nature and desirability of that position, against the apparent wish of the Tribunal or its Chairman. This is even more serious given that all members of the Tribunal were experienced arbitrators. They could therefore be assumed by the Russian Federation to be familiar with the main rule as shown above §§ 1017-1018 with quotations from the main arbitration regulations and the most important international literature: a secretary – let alone an assistant – may not make any substantive contribution to the formation of arbitrators' opinions, except in special cases and if there are relevant agreements to the contrary based on informed consent.

Re (c) and (d): Valasek's invoices and fee

1032. For the first four years of this Arbitration – phase 1 regarding jurisdiction and admissibility – Valasek invoiced a total of 381 hours. Of those hours, 100 hours were spent on merely attending the hearings in Autumn 2008. For the same period – i.e. prior to the start of the work on the Interim Awards that were not rendered until 30 November 2009 – Chairman Fortier invoiced over 490 hours and arbitrator Schwebel even invoiced more than 564 hours. Consequently, the Russian Federation could not conclude in any way from

¹⁷¹⁴ See the complete transcript of the introduction of Valasek by Fortier in § 970 above.

Valasek's invoices that contribution to the substance of the Interim Awards was too large, especially since that work was still entirely or at least largely in the future.

1033. It was not until the Final Awards of 18 July 2014 were rendered that the Russian Federation was confronted with the towering fees invoiced by Valasek, amounting to nearly €1 million. It was only on the basis of the time sheets provided by the PCA Secretariat at the request of the Russian Federation, on 6 October 2014, that the Russian Federation could deduce that Valasek had declared between 40% and 70% more hours than the three Arbitrators in that second phase. Since the PCA Secretariat had not prepared any interim time sheets after 4 February 2009, the Russian Federation neither could nor should have been aware of Valasek's excessively labour-intensive contributions to the final decision of the Arbitration Court prior to having read the Final Awards and, in particular, the letter of 6 October 2014 from the PCA Secretariat. Furthermore, there were no other reasons for the Russian Federation to assume such a disproportionate interference on Valasek's part.

1034. Nor could the Russian Federation conclude from the increase of Valasek's hourly rate from €250 to €325 in early 2012 at the unilateral request of Chairman Fortier (also Valasek's employer) that the nature and scope of Valasek's interference had increased to such a degree that the presumption of prohibited delegation was justified. The initial hourly rate of €250 in 2005 did not deviate from the hourly rates of junior associates at large US law firms, and the new hourly rate of €350 imposed by Fortier in 2012 did not deviate from that of senior associates at the same kind of firms, with whom Valasek – a lawyer since 2000 – was certainly at a par. HVY had initially agreed to the increase of the hourly rates of both the Arbitrations and their assistant. The Russian Federation reasonably had to follow this example at the time.

Re (e) and (f): Valasek's involvement and the words of thanks he received

1035. It eludes the Russian Federation why it could have known (or should have understood) only on the basis of the Valasek's presence at the hearings and the statement of his name and position on the documents originating from the Tribunal that the Tribunal had delegated substantive 'decision-making' tasks to Valasek. After all, the presence at hearings and the 'copying' or statement of his name in communications are entirely appropriate in light of the first and only explanation of his task as assistant in the "conduct

of this case” and as an alternative communication channel. The Russian Federation reminds this Court of Appeal that in these setting aside proceedings it has never raised any objection to Valasek’s possible drafting of memorandums, summaries, reports, etc., as its complaints in this matter were and are focused exclusively on his unauthorised interference with the authoring of crucial, substantive chapters of the Final Awards and the total lack of any and all transparency beforehand on the part of the Tribunal.

1036. HVY cannot seriously rely on the words of thanks expressed by Chairman Fortier and, lastly, also by a lawyer for the Russian Federation expressed to Valasek (*and to others*). Words of praise expressed to all employees, secretaries, court reporters, assistants, etc. are part of the fixed ritual on such occasions. Neither the words of Chairman Fortier at the conclusion of phase 1 on 1 December 2008 – thanks to Valasek for the help and assistance he already provided and will continue to provide to the Tribunal¹⁷¹⁵ – nor his words at the conclusion of phase 2 – thanks for Valasek’s assistance; he is a complete assistant¹⁷¹⁶ – allow any conclusion to be drawn by the Russian Federation about Valasek’s involvement in the Tribunal’s formation of substantive opinions.

1037. For the sake of good order, the Russian Federation reminds this Court of Appeal of Fortier’s own statement in the framework of another, later arbitration, quoted in § 983 (with footnote 1657) above that “*Mr Valasek was not involved and did not play any role in the Tribunal’s decision-making process*” and “*did not write the Tribunal’s reasoning and conclusions of the Yukos Awards.*” HVY also relies, in a downright misleading manner, on the gratitude that lawyer Friedman, on behalf of the Russian Federation allegedly expressed at the final hearing on behalf of the Russian Federation, to thank Valasek for the “wonderful support” he had provided to the parties, since in reality, as can be read in the transcript,¹⁷¹⁷ Friedman expressed his words of thanks in one sentence to the Tribunal, Valasek, the secretariat and the court reporters for “*the wonderful support that we have had during this hearing.*” Even apart from the fact that this concerned the closing hearing, the Russian Federation also did not express in these words of thanks that it knew or suspected that the court reporters would co-author the Final Awards.

¹⁷¹⁵ See, *inter alia*, SoA, § 795.

¹⁷¹⁶ See, *inter alia*, SoD, § II 621.

¹⁷¹⁷ See, *inter alia*, the contrast between SoD, Part II, § 621, conclusion, and the Transcript Hearing on the Merits, Day 17, 247: 20-24.

(b)(viii) Judicial customs do not legitimise a delegation

1038. HVY wrongly rely on the fact that some courts, both in the Netherlands and elsewhere, can also be assisted ‘substantively’ by assistants (clerks and the like). However, the tasks and methods of general courts differ substantially from those of arbitrators in this respect. Arbitrators are carefully selected by parties themselves and appointed per case for (i) their specific knowledge experience, and (ii) the time they are able to spend on the case, while (iii) they are also remunerated accordingly high as professionals engaged on a commercial basis.¹⁷¹⁸ Therefore, their appointment is ‘*intuitu personae*’, as already emphasised above. They may, in principle, only entrust the institutional organisation and/or a secretary with the non-material, subordinate and supportive (organisational, administrative and technical) tasks. Delegating the preparation of ‘substantive’ aspects of the assignment they accepted themselves is only permitted provided that this (a) relates to neutral issues, (b) has been communicated to the parties in advance and in a clear and specified manner, and (c) the express consent has been obtained from the parties to this end. However, it has gone seriously wrong in these Arbitrations in all three aspects.

1039. The position of ‘scribes/clerks’ and the like, which is known among some Dutch courts and in other jurisdiction, is aimed at providing institutionally established support to the relevant regular law court with a legally substantive task that has been recognised officially. Even though such a jobholder will have to strictly observe the guidelines of the courts in question, in advance and afterwards, arbitrators cannot hide behind this ‘formal’ role allocation. Any person who, from a formally responsible position, has had “competent juniors” prepare drafts for him/her knows that such a draft is more easily followed than adapted. Such support and trust therein is socially accepted in numerous – including responsible – positions but this does not apply to arbitration, as is evidenced by the long series of quotes in §§ 1017 and 1018 above.

1040. Any person who has had to prepare and substantiate a decision or an opinion by himself more often is familiar with the phenomenon of an adjustment and reconsideration that has gradually proved necessary with respect to the initial design. Of course, this occurs even more often if, among colleagues, one bears the responsibility to prepare such a decision or opinion. For this reason, too, a tribunal may not delegate its substantive decision and

¹⁷¹⁸ In these Arbitrations, Fortier et al. first charged € 750 and later € 850 per hour. See also SoR §§ 581-585 about these rather unique rates.

substantiation tasks with regard to controversial aspects to an “assistant”. It may not do so either by giving this employee the provisional conclusion reached ‘in chambers’ as instructions and carefully checking the employee’s elaboration thereof.¹⁷¹⁹

(b)(ix) Non-applicable exceptions to the prohibition on delegation

1041. The references made by HVY to a deviating practice that is indeed present in some branches or occasional disputes are not relevant to the present case. This usually relates to the appointment of one or more ‘technical expert(s)’ – from auditor to IT worker and from structural engineer to art historian etc.– to arbitrator(s). The organising institute or the arbitrators themselves will then engage a lawyer as secretary with the explicit- or implicit permission of the parties. In these kind of arbitrations, a more substantive role of such legal expert-secretary is inevitable and even envisaged, as, generally, the relevant arbitrator-expert will have virtually no idea about the applicable substantive and procedural rules of law.

1042. In those cases, the parties, with their own ‘choice of forum’ and/or appointment policy, already unambiguously chose for an own role of such a legal expert-secretary, in addition to – and in part even exceeding that – of the arbitrator. Nothing is wrong with this, as arbitration exist by the grace of a way of dispute settlement by ‘private judges according to private rules’ agreed – incidental or institutional – voluntarily by the parties. As regards the help of a legal expert-assistant, the three pre-eminently legally qualified and highly practically experienced Arbitrators that formed the Tribunal in these Arbitrations may naturally not be equated with the technical experts from the example.

(b)(ix)(i) Case law of foreign regular courts and Dutch doctrine

1043. In their Statement of Appeal (§§ 794 et seq.), just as in their Statement of Defence (§§ 609 et seq.), Statement of Rejoinder (§§ 354 et seq.) and their Written Pleadings (§§ 150 et seq.), HVY argue not only that the use of secretaries and/or assistants by arbitrators is not explicitly prohibited by the Dutch Code of Civil Procedure and the UNCITRAL Arbitration Rules, but also that this custom has been approved in regular court case law of leading arbitration countries. HVY rely in this regard on four rulings rendered in Italy,

¹⁷¹⁹ A-G Timmerman’s CPG quote in the *Meavita* case, referred to in § 1000 above, should also be recalled.

Switzerland, Germany and England. When reading those rulings, however, it turns out they actually support the Russian Federation's position; at least not that of HVY.¹⁷²⁰

1044. In its ruling of 7 June 1989 (Exhibit HVY-121), the Italian Court of Cassation considered any delegation by arbitrators of their decisive task impermissible and therefore set aside the arbitral award. This case concerned a technical construction dispute, which fell entirely within the arbitrators' scope of knowledge and experience. However, they had no knowledge of legal matters whatsoever, which was why they engaged a legal adviser. The Italian Supreme Court decided as follows – stated in English:

“Two principles were thereby violated: the principle according to which the decision must be rendered by a legally constituted judge, and the personal character of the arbitral mission, which the parties confer upon the arbitrators intuitu personae. (...) The issue is whether Italian procedural law allows arbitrators (...) to delegate to an expert to decide legal issues which are essential to the decision-making process. This question must be answered in the negative. (...) Under Italian procedural law it does not seem possible to allow (the arbitrators) to delegate to a third person to assess the legal issues which are relevant for the decision-making process. (...) Hence the Court of Appeal's holding that the parties referred their dispute to the arbitrators and therefore could not deny them the faculty to seek the legal advice of an expert, is erroneous. (...) The above-mentioned principle is a structural element of the Italian legal system and cannot be derogated from contractually by the parties who require from the arbitrators a decision according to the law, and even less by the arbitrators.”

1045. The German *Bundesgerichtshof* adopted a more liberal and modern approach in a ruling dated 18 January 1990 (Exhibit HVY-123). This case was about the recognition of an arbitral award handed down in England under English law by a tribunal of the GAFTA (Grain and Free Trade Association). The arbitrators were assisted by a legal adviser who addressed the court and asked the parties questions during the hearing, who made recommendations about the applicable law during the deliberation in chambers, and, lastly, who had recorded the decision and the substantiation thereof in writing. This was the conventional practice according to the GAFTA Arbitration Rules and an earlier attempt to contest this arbitral award before the English court had therefore failed. The BGH decided that, as such, this assistance by a legal advisers, which was conventional practice in these arbitration proceedings, alone does not prevent the recognition of the arbitral award, as it did not constitute a manifest infringement of “*wesentliche Grundsätze des deutschen*

¹⁷²⁰ See SoR, footnote 832.

Rechts”. A comparable judgment would be conceivable in the Netherlands as well, because the arbitrators in the GAFTA case – as opposed to the present Arbitrations between HVY and the Russian Federation – were all professional technicians without any legal acumen and the professional parties were familiar with the GAFTA system.

1046. An English High Court judgment from 2014, handed down between Sonatrach and Statoil (Exhibit HVY-124), concerned the allegation that arbitrators delegated their decision-making task to their secretary by having the secretary take part in their deliberations. The most striking part is probably that Sonatrach, as claimant in the setting aside proceedings, did not present any factual evidence for this delegation allegation, which, according to the court, was “*a very serious allegation*”. Also important is that the tribunal informed the parties in an early stage already that it wanted to engage the services of a secretary: “*in assisting the Tribunal and its Chairman in the administrative tasks for the proceedings, the organization of the hearings and the preparation of documents that may be useful for the decision. In no way the Administrative Secretary will have the right to participate in the decision.*” The parties did not object to this intention. What Sonatrach accused the tribunal of specifically was only that the secretary had drafted three memoranda for the tribunal. As stated before in the first instance and in this Defence on Appeal, there is no objection whatsoever against secretaries drafting purely informative memoranda. This is all the more cogent as, in the English case under discussion, such a task was approved by the parties from the very outset.

1047. The fourth case relied on by HVY relates to a judgment handed down by the Swiss *Bundesgericht* on 21 May 2015 (Exhibit HVY-122). The underlying dispute was about project owner (B) who engaged contractor (A) for a renovation project, whereby D was appointed as arbitrator for any disputes that might arise. D was also director and major shareholder of company C, which arranged for the architecture on behalf of B. This relationship between D/C and B had been known to A from the outset. The arbitration agreement provided that D had to assess the dispute *ex aequo et bono*. Because D was knowledgeable about ‘the construction industry’, but not about legal rules, he informed the parties right away that he would engage the assistance of a lawyer/secretary and a lawyer/adviser. The parties did not object to this. It was not disputed, at least not seriously, that the arbitrator assessed the dispute himself. He merely engaged the assistance of the lawyer/adviser so as not to make any legal errors. The Swiss ruling demonstrates that A’s objections – just as in the English case – lacked any factual basis. Ergo, this case also

concerned a technical arbitrator who engaged the assistance of a legal expert in full transparency and with the parties' consent.

1048. HVY further argue that Dutch doctrine supports the drafting of arbitral awards by a secretary and/or assistant.¹⁷²¹ To the extent that HVY refer once again to preparatory memoranda and summaries, it has been argued repeatedly in the foregoing that this ground for setting aside has no relation to this. Insofar as it concerns the actual drafting of *substantive* parts of the arbitral award, it has been clarified repeatedly in the foregoing that such is contrary to the purport of Article 1026(1) DCCP (uneven number of arbitrators) and Article 1065(1)(a) DCCP (mandate based on *intuitu personae*). Based on the Supreme Court ruling in *IMS/Modsaq*¹⁷²², international arbitration practice colours in part the procedural regime for international arbitration proceedings in the Netherlands. To this end, reference is made once again to the extensive overviews regarding arbitration regulations and recommendations, as well as to the international arbitration literature in §§ 1017 and 1018 above, with 'transparency' and 'informed consent' as central requirements.

1049. The Russian Federation furthermore refers to its argument regarding the task of a secretary according to the Dutch legal literature in Statement of Reply §§ 599-604. Apart once again from the instance in which the tribunal consists exclusively of professional technicians that must necessarily be assisted by a lawyer/secretary, which is irrelevant in these arbitrations, HVY can only rely on a contribution by Smakman.¹⁷²³ In it, she chiefly discusses the production of summaries of the case file and legal inquiries in addition to participating in the deliberations in chambers and minute-keeping of said deliberations. Moreover, she considers it acceptable for the secretary to "assist in drafting (parts of) the award". As already stated in the Statement of Reply, greater authorities in the field of arbitration, such as Professor Sanders, S.L. Buruma and NAI managing director Von Hombracht-Brinkman, and Professor De Ly later on, have taken a stance against this view expressed by Smakman. To the extent HVY wish to rely on Professor Snijders, they ignore the fact that his support for an active role of a secretary related to construction arbitrations and the like, which are

¹⁷²¹ See SoD, Part I, § 174 and SoD, Part II, §§ 609 et seq., SoRej., §§ 354 et seq., and SoA, §§ 796-797. Incidentally, absolutely nothing is provided in respect of 'assistants' in either the doctrine or case law.

¹⁷²² Supreme Court 17 January 2003, *NJ 2004/384*, see in particular ground 3.3.

¹⁷²³ See M.P.J. Smakman, '*De rol van de secretaris van het scheidsgerecht belicht*', *TvA* 2007/2, § 4.

actually characterised by the circumstance that arbitrators themselves have no legal expertise.

1050. Last but not least, the Russian Federation emphasises once again that Valasek’s contested role as important drafter of three crucially important chapters of the Final Awards is incompatible with the requirements of transparency and informed consent. He was introduced to the parties as ‘assistant’ – not as secretary – and his range of duties was presented to the parties as being limited to logistics and communications. Dutch doctrine, like international doctrine, therefore does not offer any support for him acting as drafter of the Final Awards. This is not changed by the fact that the Arbitrators signed his drafts.

(c) ***The scientific evidence that Valasek has written essential components of the Final Awards***

1051. In §§ 986-991 above, reference is made once again to the research reports of Dr. Carole Chaski, a U.S. forensic linguist, specialised in statistic computer analyses of texts in view of, among other things, establishing authorship. These reports have been submitted in its Statement of Reply or during the Oral Arguments, respectively, in the first instance. Exhibit RF-189 to the Statement of Reply, hereinafter also “Chaski I”, respectively Exhibit RF-215 submitted during the Oral Arguments, hereinafter also referred to as “Chaski II”.

1052. Using comparative computer analyses of legal publications by each of the four potential authors¹⁷²⁴ individually, on the one hand, and the crucial chapters IX, X and XII of the Final Awards,¹⁷²⁵ on the other hand, whilst applying scrupulous control and verification techniques (cross-validations), Dr. Chaski has demonstrated in these reports with a high probability of over 95% that Valasek wrote 78.57% of chapter IX (Preliminary Objections), 65.38% of chapter X (Liabilities) and 70.69% of chapter XII (Quantification of Claimants’ Damages). In short, approximately 2/3 to 3/4 of these findings supporting the order against the Russian Federation have been written entirely and exclusively by Valasek.

¹⁷²⁴ The three Arbitrators and their assistant Valasek.

¹⁷²⁵ These three chapters were selected for Chaski by the Russian Federation’s legal counsel with a view to their legal nature and their varied legal perspectives, in addition to the fact that these chapters contain the principal basis for the Tribunal-imposed orders against the Russian Federation.

1053. The supplementary research by Dr. Chaski that was submitted during the Oral Arguments before the District Court derives its added value from the fact that, in this research, she has taken as much of the criticism expressed in HVY's Statement of Rejoinder (§§ 366-369) in respect of Chaski I, which she herself does not endorse, into account as possible. On the basis thereof, and applying the (in principle) same method, she performed new tests on the same material and made new calculations. For the research of Chaski II, for example, the so-called 'outliers' – aberrations that are not representative of the style characteristics of the author in question – were omitted; for instance, she replaced the binary model (*either* Valasek *or* any combination of the three Arbitrators) with a quaternary model (analysis of all subsections of the FA chapters IX, X and XII on the basis of style characteristics of all of these four potential authors individually).
1054. Chaski II demonstrates that, even though the exact percentages obviously differ when applying these different testing methods, the conclusion remains fundamentally unchanged compared to Chaski I: Each time, Valasek single-handedly wrote significantly more than half of chapters IX, X and XII.
1055. In an attempt to disprove the research method applied in and the results generated by Chaski I and II, HVY submitted with their Statement of Appeal (§§ 802-804 in particular) a report by two linguistics professors: Coulthard and Grant (Exhibit HVY-D.6). This report aims to provide a more scientifically-dressed supplement to the criticism of Chaski I already formulated in the Statement of Rejoinder. The criticism expressed by HVY or Professors Coulthard and Grant, respectively, in respect of Chaski I and II is not only formulated incorrectly, but also lacks sound scientific basis in material respects and furthermore contains many factual inaccuracies. This can be explained by the fact (i) that, prior to being awarded emeritus status, Professor Coulthard was the 'front-rank man' of a subjective – instinctive and intuitive – assessment method of texts based on criteria specified *ad hoc*, and (ii) that Grant did not have any relevant first-hand experience either with statistical authorship research based on objective computer analyses.
1056. The Russian Federation considers it typical that HVY's statement of appeal does not contain a more in-depth discussion of the alleged 'scientific' substantiation by Professors Coulthard and Grant of HVY's previous criticism of Dr. Chaski. They confine themselves in this regard to half a page (§ 803, p. 276) and global references in four footnotes (617 through 620) to passages from that new report. Many of the points of criticism expressed

by Professors Coulthard and Grant are not taken over by HVY, apparently because they do not share this criticism or rightly realise that this would not benefit their defence. These experts of HVY suggest, for example, that more or other than the four authors considered by Dr. Chaski have or could have written or co-written the Final Awards. Professors Coulthard and Grant conveniently refrain from indicating who this might be (PCA secretaries, work students, advisers of HVY?). However, if this suggestion were to be true, which they themselves have not investigated, this establishes the Tribunal's violation of its mandate even more clearly.

1057. The only specific criterion that Professors Coulthard and Grant suggested themselves, and which Dr. Chaski according to them wrongly did not use in her computer analyses, is a comparison of the length of the sentences in the own publications of the three Arbitrators and Valasek against those in the three Final Awards chapters investigated. The application of the criterion recommended by them would, however, lead to the conclusion that neither Valasek, nor any Arbitrator, authored the Final Awards. This is because the sentences in the Final Awards are substantially longer than those in the own publications by Valasek and the Arbitrators. It is not surprising that HVY suppressed this 'scientific discovery' by Professors Coulthard and Grant in their Statement of Appeal. Incidentally, this criterion – while appropriate for their intuitive method – is not supported in the objective computerised stylometry.
1058. It is downright incomprehensible that Professors Coulthard and Grant, who tout themselves as much-consulted experts in the field of author identification – by courts as well – have not even begun to try and demonstrate in their report that the three Arbitrators, or any combination thereof, are the principal authors of the Final Awards, or that Valasek has not authored the Final Awards, or at most a small or substantively subordinate part thereof. Thus, the research findings of Chaski I and II are not refuted; but merely smeared. The conclusion here is that HVY apparently believed that such an own research by Professors Coulthard and Grant would not benefit them at all.
1059. As already stated, Dr. Chaski herself wrote a 'Response Report' (Chaski III: **Exhibit RF-D20**) further to the highly critical review report Professors Coulthard and Grant wrote in respect of her research. Moreover, the Russian Federation requested a second opinion from Professor Walter Daelemans, Professor at the University of Antwerp and world-renowned expert in the field of computational linguistics, including computational stylometry

(including authorship attribution). In the early 1990s, Professor Daelemans was the European pioneer of the so-called machine learning approach to natural language processing. This second opinion in view of the report by Professors Coulthard and Grant is hereby entered into the proceedings (Daelemans I: Review Report, **Exhibit RF-D21**). The Russian Federation subsequently found Professor Daelemans prepared to conduct an own empirical investigation into the most likely authors of chapters IX, X and XII of the Final Awards. This report of Professor Daelemans's own research is hereby submitted as well (Daelemans II: **Exhibit RF-D22**).

1060. In his Review Report, Professor Daelemans is very critical – as is Dr. Chaski III, of course – of Professors Coulthard and Grant's criticism of Chaski I and II. Professor Daelemans concludes that the original conclusion of Chaski I and II – to wit that Valasek authored most of the three selected Final Awards chapters – remains intact in his own investigation and that the methodology applied by Dr. Chaski is correct. Professor Daelemans concludes on that basis that it can be said with 99% certainty that *at least* 51% of those three chapters was written predominantly by Valasek.¹⁷²⁶ According to Professor Daelemans, the criticism expressed by Professors Coulthard and Grant is exaggerated and often irrelevant to boot, because their methodological remarks do not render Dr. Chaski's results useless or unreliable and Chaski I and II have moreover been prepared on the basis of correct methodology and with the application of thorough cross-validations.¹⁷²⁷

1061. In his own investigation into the authorship of the three selected chapters of the Final Awards,¹⁷²⁸ Professor Daelemans used (i) the same legal contributions of the four potential authors that Dr. Chaski used, and moreover (ii) two additional legal contributions by each of these four potential authors. Applying his own linguistic and statistical methods for the rest, Professor Daelemans investigated the possible contributions of Valasek and the three Arbitrators on the basis of both a binary and a quaternary model. The conclusion he reached entirely independently from Dr. Chaski's research method and results is that it can

¹⁷²⁶ See Daelemans I, **Exhibit RF-D21**, 'Executive Summary', § 2.1.

¹⁷²⁷ See Daelemans I, **Exhibit RF-D21**, 'Conclusion', § 8.2.

¹⁷²⁸ See Daelemans II, **Exhibit RF-D22**, Expert Report on Authorship Attribution to the Final Awards using Machine Learning Methods.

be said with 95% certainty that Valasek authored *at least* 41% (in the binary model) or 62% (in the quaternary model) of the three selected Final Awards chapters.¹⁷²⁹

1062. The Russian Federation believes that this Court of Appeal, if it should proceed to addressing this ground for setting aside, should take cognisance itself of the six reports currently available, which are all drafted in English, on the extent to which Valasek has been the principal author of chapters IX, X and XII of the Final Awards (Chaski I, II and III; Coulthard and Grant; Daelemans I and II). To this end, the Russian Federation inserts the five reports it submitted itself and, in doing so, adopts the contents thereof as its own propositions in their entirety. Taking note of these reports undeniably requires considerable time and effort from lawyers not familiar with stylometric statistics and linguistics. However, it would be of no benefit to this Court of Appeal if – in lieu thereof – a short Dutch summary of these reports were to be included in this defence on appeal. This is because such a summary can never do justice to the step-by-step and meticulous technical presentations on this subject in general and on its practical application to this particular case.¹⁷³⁰ The Russian Federation therefore explicitly offers to have this Court of Appeal hear Dr. Chaski and Professor Daelemans as expert witnesses if it would consider such useful for its understanding of the subject matter at hand. The Russian Federation also recalls its offer to provide evidence in respect of this subject matter by hearing Mr Valasek as a witness himself.

1063. This chapter concludes with a number of salient errors and prejudices from the Coulthard and Grant report, on which HVY's 'factual' defence against this ground for setting aside is ultimately based.

- (a) Following on from the Coulthard and Grant report, HVY refer in § 804 of their statement of appeal to their claim in rejoinder § 621 and written pleadings § 158 that the scientific work of Dr. Chaski cannot be relied upon, because "*in recent decades, it has been systematically ruled out as evidence in judicial legal in recent decades*". This reproach is below par, because Chaski I already referred in § 7, in conjunction with 1 through 3, to three

¹⁷²⁹ See Daelemans II, **Exhibit RF-D23**, 'Conclusion', §§ 6.3-6.5.

¹⁷³⁰ For this reason, no reference is made above or below to specific sections of the three Chaski reports and the two Professor Daelemans reports. This is because their statements can only be understood properly in the broader and deeper context of their arguments.

more recent Dr. Chaski reports from 1995, 1996 and 2004 that were accepted by the U.S. court – while applying the strict Daubert standard. The same applies to three expert reports from 2008 and 2012 that Dr. Chaski furnished later in this field.¹⁷³¹ Annex H to Chaski III also demonstrates that, between 2004 and 2017, she furnished 39 expert reports based on SynAID in pending or imminent legal proceedings. None of these reports have been rejected. Five of these reports were produced at the request of the government.¹⁷³² The emphasis that HVY place in rejoinder § 369 and statement of appeal § 804 on the 2005 rejection of a Dr. Chaski report in the *Mowry* case is likewise below par. That report had nothing to do with stylometric methods or author identification. As had already been explained in Chaski II (§ 24), and HVY therefore should have known, Dr. Chaski reported in the *Mowry* case on the possibility that scenes from a film scenario by B were derived from an earlier film scenario by A.

- (b) The criterion of sentence length in the examples or test material, as recommended by Professors Coulthard and Grant as an alternative to Dr. Chaski's method, has already been touched upon briefly. In this respect, HVY are shooting themselves in the foot, as the application of that criterion would bring about the elimination of the three Arbitrators as potential authors altogether. Moreover, this criterion is not applied in any serious stylometric research.
- (c) The refutation of the criticism expressed by Professors Coulthard and Grant in respect of the fact that Chaski I and Chaski II arrive at (marginally) different percentages for the 'attribution' of certain sections of chapters IX, X and XII to the four distinguished potential authors bears repeating as well. After all, it speaks for itself that the results would show minor deviations when applying different measurement methods. Indeed, a 'unisono' outcome might not be correct.
- (d) Already mentioned, therefore, is the suggestion of Professors Coulthard and Grant that more or other authors than the three Arbitrators and Valasek have written or co-written the Final Awards. Professors Coulthard and Grant do

¹⁷³¹ See Annex H to Chaski III, §§ 17, 19 and 24.

¹⁷³² See Annex H to Chaski III, §§ 16, 20, 25, 34 and 35.

not provide any factual research data for this claim. HVY wisely refrained from including this bare suggestion of Professors Coulthard and Grant in their submission, because this might undermine their defence, both due to the lack of a relevant factual basis and due to the consequent introduction of another mandate violation by the Arbitrators.

- (e) Professors Coulthard and Grant suggest that the methods used by Chaski I and Chaski II are improper and inadmissible, because authorship is attributed 'by default' to Valasek therein if no other author(s) can be given clear priority for this authorship. This once again unsubstantiated suggestion had been consigned to the realm of fantasy by Chaski I and II 'beforehand'. Chaski III and Daelemans I confirm that Professors Coulthard and Grant formulated an empty accusation in doing so. An equally, unmistakably empty accusation is Professors Coulthard and Grant's assertion that Dr. Chaski's method would not be able to recognise a collaboration of different authors.
- (f) HVY also reiterate – relying in part on Professors Coulthard and Grant – that Dr. Chaski, by omitting 'outliers' from the sample material, manipulated the outcome of her research in an unacceptable manner. This allegation is malicious as well, because in Chaski II, as has been confirmed by Daelemans I, the outliers were no longer omitted, while the findings of the study do not differ substantively from those of Chaski I. Outliers have not been omitted from Daelemans II either, while the outcome thereof supports the outcome of Chaski I and II. Ergo, Professors Coulthard and Grant have once again failed to properly verify their criticism.
- (g) Just as malicious is the accusation of HVY and Professors Coulthard and Grant that Dr. Chaski's concealment of her method on the basis of her IP right would mean that this method is not transparent and verifiable for third parties. They suggest that, because of this, there is an unscientific black box with input as unclear as output. This accusation is manifestly incorrect as the method applied by Dr. Chaski has been explained in her many publications and the application thereof can also be verified via the annexes to Chaski I and II. More importantly still is the fact that all methods, programs and codes used by Dr. Chaski, as has been confirmed in Daelemans I, can be obtained *free of charge* by linguistic researchers, HR professionals and

governments (particularly police and justice departments). However, Professors Coulthard and Grant did not even make an attempt to do so, rendering their criticism both inaccurate and unfounded. In addition, Grant already used Dr. Chaski's method, or a variation thereof, in an earlier publication. In Chaski III, Dr. Chaski moreover explains why, like many of her colleagues, she applies this practice to prevent cowboys and malicious parties from abusing her method. The 'black box' accusation is certainly not in keeping with Professor Coulthard's approach, as he devises his criteria *ad hoc* on a case-by-case basis.

- (h) Another red herring thrown in by HVY, supported by Professors Coulthard and Grant, is the allegation that there is a variety of reasons as to why the legal publications by Valasek and the three Arbitrators are unfit to be used as sample and research material, which has been done by Dr. Chaski (and later in Daelemans II).- According to Professors Coulthard and Grant, for example, articles in legal journals and lectures redacted for publication belong to a different 'linguistic genus', and are incomparable to considerations in arbitral awards. Both Chaski III and Daelemans I and II demonstrate that this concerns a red herring and that Professors Coulthard and Grant should have known this from their own research and publications. This applies as well to different aspects of this same red herring, such as that some of the contributions examined are 'too old' and have 'possibly' – as evidenced by a word of thanks in a footnote – been written/co-written or redacted/co-redacted by third parties. What HVY, together with Professors Coulthard and Grant, lose sight of here is that the scrupulous 'cross-validation' technique applied by Dr. Chaski identifies and rules out such 'data contamination' in advance. Chaski III even shows empirically that a redacted sample used to this end by Professors Coulthard and Grant is flawlessly attributed to the correct – original – author.
- (i) Professors Coulthard and Grant heavily criticise the use by Dr. Chaski of DFA (Discriminant Function Analysis) as a statistical method. According to them, some conditions for the application of this method, such as those evident from a manual they cited, have not been satisfied. However, Professors Coulthard and Grant hereby disregard, as Chaski III and Daelemans I demonstrate, that this method – also according to the manual

cited by Professors Coulthard and Grant – is by no means unfit for a broader use. This applies in particular if, such as in the present case, careful cross-validations prove that the application of DFA leads to good results. Chaski III furthermore demonstrates that the propagation by Professors Coulthard and Grant of the use of the linguistic SFL theory (Systemic Functional Linguistics) and their fierce attack on the PSG theory (Phrase Structure Grammar) applied by Dr. Chaski are both unfounded. Professors Coulthard and Grant paint a unilateral and outdated picture of PSG, especially in respect of where Dr. Chaski uses this method in combination with an approach based on the Markedness theory, while they disregard the fact that SFL has never been successfully used for authorship identification.

1064. Lastly – even though this long paragraph is by no means an exhaustive representation of Dr. Chaski and Professor Daelemans’s criticism of the review by Professors Coulthard and Grant – it should be pointed out that Professors Coulthard and Grant wrongly suggest that the publications by Dr. Chaski have not been subjected to peer review, or only barely, and are therefore not cited in the linguistic literature, or only barely. It is demonstrated in Chaski III that her publications, bar some exceptions indicated as such, certainly have been successfully subjected to peer review – also in a journal edited by Professor Coulthard himself – and that she can therefore boast more successful peer reviews than Professors Coulthard and Grant themselves. Dr. Chaski also demonstrates that her work in a normative publication scores considerably higher than Professors Coulthard and Grant in respect of being cited in academic literature by third parties.

(d) ***Conclusion: the Arbitrators have, by delegating part of their task to their assistant, violated their mandate and/or fulfilled it with a ‘fourth arbitrator’***

1065. With the delegation of a substantial part of their substantive task to their ‘logistical’ assistant (Mr Valasek) – without any transparency or consent of the parties – the Arbitrators have not personally fulfilled their mandate, and thereby violated it. This impermissible extent of delegation is evidenced by the disproportionately large number of hours Mr Valasek spent on the second phase of the Arbitrations, such in view of both the number of hours the Arbitrators themselves spent during that phase, and the fact that, pursuant to the Terms of Appointment, the Secretariat of the PCA took care of the entire administration and organisation of the Arbitrations. This impermissible extent of delegation

also emerges from the objective research by two linguistic experts, performed independently from one another, as the outcome thereof is that it can be said with 95% certainty that at least over half of three crucial chapters of the Final Awards was written by Mr Valasek – so not by one or more Arbitrators. In addition, the composition of the Tribunal was not proper in view of the applicable Dutch Code of Civil Procedure and the UNCITRAL RULES as the Tribunal ‘de facto’ fulfilled its mandate with a ‘fourth arbitrator’. The Yukos Awards must therefore be aside on the basis of Article 1065(1)(c) and/or (b) DCCP.

VI. GROUND FOR SETTING ASIDE 4 - AWARDS ARE NOT ADEQUATELY REASONED

A. Introduction

1066. In the first instance, the Russian Federation has advanced that the Yukos Awards should be set aside, *inter alia*, because they are not reasoned within the meaning of Article 1065(1)(d) DCCP. The violation of the duty to state reasons in the Yukos Awards relates to the following points:

- (a) the determination of the damages (Reasoning Ground 1);
- (b) the Arbitral Tribunal has ignored all evidence that also Yukos' Mordovian companies were sham companies (Reasoning Ground 2);
- (c) the Arbitral Tribunal has based various considerations on its own speculations (Reasoning Ground 3);
- (d) the conclusions of the Arbitral Tribunal regarding the YNG auction are inherently inconsistent (Reasoning Ground 4).

1067. The Russian Federation comprehensively maintains the substantiation that it gave in the first instance for this setting-aside ground of failure to comply with the reasoning requirement (Article 1065(1)(d) DCCP). For the convenience of this Court of Appeal, the Russian Federation will in this chapter, without prejudice to the devolutive effect of the appeal, once again give the essence of its previous argument in this respect. It should also be noted that, besides the damage calculation, HVY's Statement of Appeal does not address the non-fulfilment of the reasoning requirement.

1068. As noted previously, this Court of Appeal need not confine itself to a discussion of the grounds for appeal of the appellant. The Court of Appeal may also immediately, or in

addition thereto, or instead thereof, proceed to a discussion and decision on the, based on the devolutive effect of the appeal, still remaining basis of the claim of the respondent.¹⁷³³ As such, it is possible to dispose of the case based on an aspect of the failure to comply with the reasoning requirement.

B. Legal Framework

1069. In the first instance, the Russian Federation demonstrated that the Yukos Awards must be set aside, showing that the Tribunal provided no reasoning, or no tenable reasoning, for various of the decisions (as discussed below) underlying its Yukos Awards. As a consequence, those decisions must be equated to supporting decisions lacking any reasoning entirely. Given that, in the view of the Russian Federation, these issues all justify more than partial setting aside only, these decisions, which lack reasoning or lack tenable reasoning, should result in the Yukos Awards being set aside in their entirety.¹⁷³⁴
1070. The Dutch Supreme Court's judgment in *Kers/Rijpma* does not overturn the precedent set by *Nannini/SFT*, as HVY imply.¹⁷³⁵ Rather, *Kers/Rijpma* uses more general terms¹⁷³⁶ to express the considerations from *Nannini/SFT*; the judgment in which a reasoning is provided yet where the decision concerned lacks any tenable explanation (*Nannini/SFT*)

¹⁷³³ See fn 1470 above.

¹⁷³⁴ See Dutch Supreme Court, 9 January 2004, *NJ* 2005/190 (*Nannini/SFT Bank*) and Dutch Supreme Court, 22 December 2006, *NJ* 2008/4 (*Kers/Rijpma*). Contrary to what HVY have asserted (in SoD Part II, § 34), *Kers/Rijpma* should not be seen as *correcting Nannini/SFT Bank*: the Supreme Court did not phrase its considerations regarding the reasoning in *Kers/Rijpma* in the same manner as it did in (for example) *Nannini/SFT Bank* in relation to the *Eco Swiss/Benetton* judgment (Dutch Supreme Court, 25 February 2000, *NJ* 2000, 508 (*Eco Swiss/Benetton*)): "This ruling [as in *Eco Swiss /Benetton*] needs to be made more specific, in that (...)".

¹⁷³⁵ SoRej., §§ 383-385.

¹⁷³⁶ Cf. De Boer & Meijer, *TCR* 2007/2, p. 55: "We wonder whether the Dutch Supreme Court's intention in the *Kers/Rijpma* judgment was not simply to phrase the magic words from *Nannini* in somewhat more general terms."

may be taken as an example¹⁷³⁷ of an award that is so incomplete that it must be equated to an award lacking any reasoning entirely (*Kers/Rijpma*).¹⁷³⁸

1071. Arbitral awards must give the reasoning for each separate element and each separate decision in the operative part of the award.¹⁷³⁹ HVY believe – incorrectly – that the case law implies that this setting-aside ground requires that "the arbitral award be considered in its entirety" and that the case law does not leave room "to question, at random, discrete aspects" of the Yukos Awards.¹⁷⁴⁰ They seek to substantiate this view by drawing on two incomplete quotes from the Dutch Supreme Court in *Nannini/SFT* and *Kers/Rijpma*. Below, the relevant sentences that HVY quote from the Supreme Court's grounds are given in full, with the excerpts quoted by HVY emphasised:

Nannini/SFT:

"This opinion needs to be made more specific, in that the absence of reasons must be equated to a situation where, although the reasoning is given, it does not offer any tenable explanation for *the decision concerned*."¹⁷⁴¹ [italics added]

Kers/Rijpma:

"Only where no reasoning is given, or where the reasoning in an arbitral award is so flawed that it must be equated to an award lacking any reasoning, may the court set aside that award on the ground given in Article 1065(1), opening lines and at d of the DCCP, i.e. that the award is not accompanied by reasoning."¹⁷⁴²

1072. It will be clear that, by quoting only the underlined phrases, HVY have taken the meaning of the Supreme Court's consideration entirely out of context. It in fact follows from the

¹⁷³⁷ Cf. Van den Nieuwendijk, *JBP* 2007/35, § 14: "To my mind, it should be seen as a bandwidth with, at one extreme, the absence of any reasoning, where the decision may be set aside without a substantive review, and at the other extreme a flawed reasoning, where the decision cannot be set aside (Benetton). These two extremes are evidently separated by a margin where a flawed reasoning can be equated to lack of reasoning (*Rijpma/Kers*). An example of a flawed reasoning that falls within this margin would be where a reasoning is given without a tenable explanation of that particular decision (*Nannini*)."

¹⁷³⁸ See also Snijders 2011, Article 1057, note 5.b: "And then came *Kers/Rijpma*. (...) Lastly, the application that the Supreme Court attaches to the criterion for setting aside decisions for lacking any tenable explanation in this instance [*Kers/Rijpma*] is particularly illuminating." [bracketed text added]

¹⁷³⁹ See also Meijer *T&C Rv* (2016), Article 1065, note 6c. This is also evident from the case law on this setting-aside ground that is mentioned in footnote 1745.

¹⁷⁴⁰ *SoRej.*, § 386.

¹⁷⁴¹ *NJ* 2005/190, ground 3.5.2, conclusion.

¹⁷⁴² *NJ* 2008/4, ground 3.3, conclusion.

Supreme Court's considerations that an arbitral award must give a reasoning for each decision: "does not offer any tenable explanation *for the decision concerned*". See also Snijders:

"It may also be assumed that the Dutch Supreme Court is referring to decisions within an award rather than to the award in its entirety, which is addressed at greater length below. (...)

This now raises the question of what the object of analysis actually is for the purposes of a review against the reasoning requirement: is it the entire arbitral award? A valid argument – and one that the Supreme Court evidently applied where it mentions the tribunal's 'opinions' and the 'decision concerned' in reference to a single award – can be made that the review must consider a greater level of detail than simply the award in its entirety (the judgment in *Kers/Rijpma* did not express this clearly; see 3. in the *NJ* annotation). Does this mean, then, that every decision that it includes must be reviewed, and if so, how is the term 'decision' defined? It may be assumed, as Sanders appears to do (op. cit. 30), that at the minimum every disposal of a principal claim may be held to be a decision that needs to be reviewed, as may — at least given the aforesaid case law of the Supreme Court from the 1970s — every disposal of an essential defence. It also seems, based on this judgment by the Supreme Court, that every decision about essential and disputed preliminary questions, for example about what substantive law should apply, must be accompanied by some degree of reasoning. This shows that the large parts of the reasoning requirement are still intact!"¹⁷⁴³

1073. Lastly, HVY assert that the Russian Federation has put forward new arguments in connection with this setting-aside ground, or have even put forward new evidence that was never submitted to the Tribunal.¹⁷⁴⁴ This is another clear example of HVY's attempts to mislead this court. It is only logical that some matters were not addressed in the Arbitrations, given that the flaws in the reasoning did not emerge until the date of the Final Awards: the flaws relate to reasoning *in* the Final Awards, and the Setting-Aside Proceedings are the first opportunity for the Russian Federation to address them.

¹⁷⁴³ Snijders 2011, Article 1057, note 5.b. See also Snijders, note on *NJ* 2008/4: "*What are in fact the objects of the reasoning requirement, I wonder: the arbitral awards or the decisions given in them? (...) That would mean that the review of the reasoning could be applied to the arbitral decisions on claims, to the arbitral decisions on essential defences and to the arbitral decisions on essential and disputed preliminary questions, for example about what laws should apply and the choice of law (though it should be noted that pure findings of law need not be accompanied by any reasoning, even in arbitrations).*"

¹⁷⁴⁴ See SoRej., § 394.

1074. Although an award will be set aside for failure to comply with the reasoning requirement in “manifest cases” only, the case law does in fact include such manifest cases.¹⁷⁴⁵ The case presently before the Court is such a manifest case, and in more ways than one. Precisely with a view to avoiding prejudice to the principle of effective arbitral procedure,¹⁷⁴⁶ the Final Awards should be set aside for (among other grounds) failure to comply with the reasoning requirement in light of the four reasons set out below.

C. Reasoning Ground 1 - The Tribunal failed to state sound reasons for its essential opinions in respect of estimating the amount of the damages

The Russian Federation refers to:		
<u>Arbitrations:</u>		
Final Awards	Chapter XII	marginal nos. 1693-1829
<u>Setting aside proceedings:</u>		
Writ	Part I, Chapter 3.5	§§ 1.184-186
SoD	Part I, Chapter 3.5	§§ 1.187 - 190
Statement of Defence	Part I, Chapter 3.5	§ 1.184-186
	Part II, Chapter 4.1	§ II.636-637
Reply	Chapter VI.C Annex I	§ 645-662
Rejoinder	Chapter 5.3	§ 389-398
Statement of Appeal	Chapter 11	§ 772-774, 790
HVY Written Pleadings	Chapter 3.5	§ 136
<u>Primary exhibits:</u>		
<u>Arbitrations:</u>		
RF-03.1.C-2.1		First Kaczmarek Report
RF-03.1.C -2.2.1		First Dow Report
RF-03.1.C -2.3		Second Kaczmarek Report
RF-03.1.C -2.4.1		Second Dow Report
RF-03.1.G-4 Kaczmarek		Kaczmarek Testimony
RF-03.1.G-4 Dow		Dow Testimony
<u>Setting aside proceedings:</u>		
RF-85		Dow Report (Summons)
RF-214		Kathleen Paisley Presentation
HVY-D6		Giles Report
RF-D18		Second Dow Report in the setting-aside proceedings
RF-D19		Hermes Report

¹⁷⁴⁵ In addition to the eight examples in SoR, footnote 869, see: Court of Appeal of Leeuwarden, 18 April 2017, ECLI:NL:GHARL:2017:3283 (*Kanzlei Rechtsanwalt/(advocaten)maatschap*).

¹⁷⁴⁶ For example, see Dutch Supreme Court, 17 January 2003, ECLI:NL:HR:2003:AE9395, *NJ* 2004, 384 (*IMS/Modsaf-IR*), ground 3.3; Dutch Supreme Court, 9 January 2004, ECLI:NL:HR:2004:AK8380, *NJ* 2005, 190 (*Nannini/SFT Bank*), ground 3.5.2; Dutch Supreme Court, 25 May 2007, ECLI:NL:HR:2007:BA2495, *NJ* 2007, 294 (*Spaanderman/Anova Food*), ground 3.4; Dutch Supreme Court, 24 April 2009, ECLI:NL:HR:2009:BH3137, *NJ* 2010, 171 (*IMS/Modsaf*), ground 4.3.1; also *cf.* ECtHR, 27 November 1996, ECLI:NL:XX:1996:AD2654, *NJ* 1997, 505 (*Nordström/Nigoco*).

Essence of the reasoning

- The Tribunal failed to state sound reasons for its own methodology of calculating the damages. This is a violation of Article 1065(1)(d) DCCP.
- The Tribunal has applied various methods in its calculation of the damages, which it had already rejected, without stating any (sound) reasons for that inconsistent method.
- In addition, the Tribunal twice ignored the relationship between profit, dividend and equity value, as such without stating sound reasons, and applied its own method of calculating the damages, leading to the consequence that the damages awarded contained a double counting of over USD 20 billion.

(a) ***Introduction***

1075. As was already set out in chapter V.D, the Tribunal's methods to calculate the amount of the damage was completely incomprehensible. In this chapter it will be explained that in doing so the Tribunal not only failed to comply with its mandate and acted contrary to public policy,¹⁷⁴⁷ but in addition also failed to state sound reasons for some essential decisions. This constitutes an independent ground for setting aside the Yukos Awards on the basis of Article 1065(1)(d) DCCP.

1076. In what follows, the Russian Federation will (again) demonstrate that the Tribunal failed to state (sound) reasons:¹⁷⁴⁸

- (a) how the Tribunal could base its calculation of the dividends on the DCF calculations of Mr Kaczmarek (HVY's expert), although it had comprehensively rejected the said calculations for the valuation of the equity value and the lost dividends;¹⁷⁴⁹
- (b) how the Tribunal could apply the RTS Oil & Gas Index, although it had rejected this use of the index, since it had been proposed too late by HVY;¹⁷⁵⁰

¹⁷⁴⁷ For the failure to comply with the mandate see chapter V.D and for the violation of public policy see chapter VII.C.

¹⁷⁴⁸ See also Writ, Chapter VII.C and SoR, Chapter VI.C, and Annex 1.

¹⁷⁴⁹ See §§ 1078-1083 on this.

¹⁷⁵⁰ See §§ 1084-1097 on this.

- (c) why the Tribunal applied a deduction to the dividends due to a lower estimated profitability of Yukos, but then failed to apply that deduction to the equity value;¹⁷⁵¹
- (d) why the Tribunal failed to compensate an intentional overestimation of the dividend, leading to a capital double counting.¹⁷⁵²

1077. The defences put forward by HVY in this framework are unfounded, incorrect and irrelevant.¹⁷⁵³

(b) ***Flawed reasoning***

Re (a): the DCF method in the dividend calculation

1078. In chapter V.D,¹⁷⁵⁴ the Russian Federation already explained that the Tribunal incomprehensibly decided to base its calculation of the dividend on the valuations drawn

¹⁷⁵¹ See §§ 1098-1103 on this.

¹⁷⁵² See §§ 1105-1113 on this.

¹⁷⁵³ In the SoRej, § 390 HVY make it appear as if the Russian Federation did not challenge the lack of (sound) reasons of the Tribunal for its estimate of the amount of the damages until its SoR. This is incorrect. The Russian Federation already put forward in the Writ (Chapter VII.C, with reference to Chapter V.D) that the damage calculation of the Tribunal with its own non-standard and fundamentally flawed methodology lacks sound reasons, given, among other things, the way in which the Tribunal's methodology and calculation deviated from what the parties had put forward in the Arbitrations. The Russian Federation further explained this in its SoR in Chapter VI.C and Annex I.

In SoRej, § 393 HVY assert that the Russian Federation's complaint with regard to the double counting cannot be allowed, since it is allegedly based on data the Tribunal did not have at its disposal. However, that assertion fails to recognise that the Russian Federation has demonstrated that it became clear already from what HVY and Mr Kaczmarek had put forward in the Arbitrations to substantiate their methods and calculations, that the method then constructed by the Tribunal would lead to errors, inconsistencies and double counting. See also § 1105 of this chapter and chapter V.D, § 935 et seq.

In SoRej, § 394 HVY assert that the Russian Federation allegedly has not disputed that the Tribunal in its calculation of the damages stayed within the limits of its discretionary power. However, the Russian Federation in fact did dispute this in a reasoned manner – see SoR, Annex I, § 77 et seq.

In SoRej, § 396 HVY assert that the fact that "*the Tribunal did not consider the DCF model suitable for the valuation of the Yukos shares [does] not mean that the Tribunal could not also use this model to estimate the lost dividend payments*". This assertion fails to recognise that the Tribunal also explicitly held with regard to the dividend calculations made by Mr Kaczmarek with his DCF model that it should be disregarded (see, among other things, §§ 1078-1079 of this chapter and chapter V.D, §§ 891-897).

In SoRej, § 397 HVY assert that the case law cited by the Russian Federation in § 646 et seq. of its SoR is allegedly "*not relevant*" here. From each of those rulings it indeed follows that a damage calculation in an arbitral award that is incomprehensible and inconsistent, is not based on what the parties have put forward and/or contains double counts, qualifies to be set aside. Accordingly, those rulings are directly relevant here.

¹⁷⁵⁴ See in particular §§ 891-897 and 924-928.

up by Mr. Kaczmarek by means of the Discounted Cashflow or DCF method. This is because the Tribunal had comprehensively rejected the Mr Kaczmarek's DCF calculations, since it turned out that Mr Kaczmarek had in his DCF analysis reasoned towards obtaining a desired result for him and HVY, respectively:

“On balance, the Tribunal was persuaded by Professor Dow’s analysis of Claimants’ DCF model, and is compelled to agree that little weight should be given to it. The Tribunal observes that Claimants’ expert admitted at the Hearing that his DCF analysis had been influenced by his own pre-determined notions as to what would be an appropriate result.”¹⁷⁵⁵

1079. The Tribunal also explicitly considered the same with regard to the dividend calculation Mr Kaczmarek had made using his DCF model:

“(…) the Tribunal is unable to dissociate them from Claimants’ DCF model, which was convincingly criticized by Respondent’s expert and its counsel.”¹⁷⁵⁶

1080. However, the Tribunal incomprehensibly arrived at the conclusion that it could nevertheless base its own method of calculating the dividend¹⁷⁵⁷ on Mr Kaczmarek’s DCF calculations. The Tribunal failed to state any (sound) reasons for this U-turn.

1081. As was also explained in chapter V.D¹⁷⁵⁸ the Tribunal tried to justify its use of this method by making it appear as if it had arrived at a determination of the dividends in a manner agreed upon between the parties. The Tribunal based this alleged agreement between the parties regarding the dividends in the DCF method on the comments of Professor Dow to Mr Kaczmarek's DCF calculations. This was untenable for two reasons.

1082. First, because Professor Dow had explicitly indicated that his comments on Mr Kaczmarek’s method could not serve as an independent calculation of damages or an endorsement of Mr Kaczmarek’s calculations.¹⁷⁵⁹ Second because the Tribunal had not (only) rejected Mr Kaczmarek's DCF calculations due to methodological or arithmetical

¹⁷⁵⁵ Final Awards, marginal no. 1785, with reference to Transcript Hearing on the Merits, Day 11, 190 (**Exhibit RF-03.1.G-4**).

¹⁷⁵⁶ Final Awards, marginal no. 1799.

¹⁷⁵⁷ See chapter V.D, §§ 924 et seq.

¹⁷⁵⁸ See in particular §§ 926-928.

¹⁷⁵⁹ See further Chapter V.D, §§ 926-928.

errors, but had held that these must be disregarded entirely since they were simply based on apre-determined notion, disguised as a substantiated damage calculation.¹⁷⁶⁰

1083. As a consequence hereof, the DCF calculations neither could or should have played any role in the ultimate damage calculation, and the Tribunal's decision to use these calculations anyway lacks sound reasons.

Re (b): the application of the RTS Oil & Gas Index

1084. In chapter V.D¹⁷⁶¹ it was also explained that the Tribunal applied the RTS Oil & Gas Index in a manner it had in fact rejected, because this method had been proposed too late by HVY.

1085. In both his damage reports, Mr Kaczmarek had only used the RTS Oil & Gas Index once, to transpose the value of specific assets over a brief period of time.¹⁷⁶²

1086. Subsequently, toward the end of the Arbitrations, HVY introduced a number of new, alternative valuations,¹⁷⁶³ in an attempt to demonstrate that these '*reasonableness checks*' based on alternative methods led to a result comparable with the valuations previously submitted by Mr Kaczmarek, and those previous valuations were therefore '*reasonable*'.

1087. Those alternative methods for the first time also entailed the transposing over time of the equity value of Yukos as a whole, by means of the RTS Oil & Gas Index, instead of the value of specific assets.

1088. However, the Tribunal rejected these new methods due to them being proposed too late, because the Russian Federation did not have had sufficient opportunity to respond to them:

“Moreover, some of these figures [including the relevant use of the RTS Oil & Gas Index, added by counsel] were only introduced by Claimants at a very late stage of the proceedings (through demonstrative exhibits at the Hearing

¹⁷⁶⁰ As explained in §§ 1078-1079 before.

¹⁷⁶¹ See in particular §§ 909-921.

¹⁷⁶² See Final Awards, marginal no. 1788, footnote 2383.

¹⁷⁶³ C-1783, C-1784, C-1785. See Transcript Hearing on the Merits, Day 17, 247:4 et seq. (**Exhibit RF-03.1.G-4**); Claimants' Post-Hearing Brief, §§ 260-262, footnote 535 (**Exhibit RF-03.1.B-6**).

and in Claimants' Post-Hearing Brief) and could therefore not be properly addressed by Respondent."¹⁷⁶⁴

1089. In keeping with this, the Tribunal ruled that none of these methods could be used to establish the value of Yukos:

“Accordingly, the Tribunal finds that none of these secondary valuation methods [including the relevant use of the RTS Oil & Gas Index, added by counsel] can serve as a suitable independent basis for determining the value of Yukos.”¹⁷⁶⁵

1090. The Tribunal thus held that transposing the equity value of Yukos as a whole over time using the RTS Oil & Gas Index was not part of the debate between the parties and could therefore not be used in determining the damages.

1091. However, here, too, the Tribunal shows an incomprehensible inconsistency in its methods. As has already been explained in the chapter V.D,¹⁷⁶⁶ the Tribunal started from determining the equity value of Yukos based on the reference date of 21 November 2007, as proposed by HVY. However, since, the Tribunal ignored the same and on its own designated the reference dates of 19 December 2004 (as the date immediately preceding the alleged expropriation) and 30 June 2014 (as the hypothetical date of the Final Awards), the case file lacked a valuation based on those reference dates.

1092. To fill this gap the Tribunal then decided to use the RTS Oil & Gas Index in fixing the equity value of Yukos as a whole. The use of that same RTS Oil & Gas Index as a method to transpose the equity value of Yukos as a whole however had been rejected by the Tribunal since it had been proposed too late by HVY.

1093. The Tribunal fixed the equity value of Yukos as a whole by transposing the equity value of Yukos it had calculated as of 21 November 2007, to the reference dates chosen by the Tribunal – 19 December 2004 and 30 June 2014, on the basis of the movements of the RTS Oil & Gas Index.

¹⁷⁶⁴ Final Awards, marginal no. 1786 (footnotes removed) (emphasis added). See the table in the Hermes' 2017 Expert Opinion (**Exhibit RF-D19**), § 40, under no. 6.

¹⁷⁶⁵ Final Awards, marginal no. 1786 (footnotes removed).

¹⁷⁶⁶ See in particular §§ 902 et seq.

UNOFFICIAL TRANSLATION

This text is an unofficial translation of the Dutch original. In case of any discrepancies, the Dutch original shall prevail.

1094. Therefore, this was exactly the application of the RTS Oil & Gas Index the Tribunal had previously rejected: transposing the equity value of Yukos as a whole over time. What is more, in the valuations that *were* part of the debate between the parties Mr Kaczmarek had used the RTS Oil & Gas Index to transpose specific assets over a limited period of time (maximum of 16 months).¹⁷⁶⁷ However, the Tribunal applied the RTS Oil & Gas Index to transpose the equity value of Yukos as a whole over a total period of almost ten years. Such an application was never proposed by the parties at all.¹⁷⁶⁸

1095. The Tribunal has not stated any (sound) reasons to justify its decision to use the RTS Oil & Gas Index in this manner notwithstanding its rejecting thereof.

1096. Instead, the Tribunal made it appear as if it was a method used and agreed by the parties, again wrongly so. For reasons already explained in greater detail in the chapter V.D,¹⁷⁶⁹ first of all this application of the RTS Oil & Gas Index had been proposed by HVY too late, thus preventing the parties from having a proper debate about it, and it certainly was not a reasoning the parties had agreed with.¹⁷⁷⁰ Second, the Tribunal misrepresented the facts by stating that both parties had identified the RTS Oil & Gas Index as a ‘reliable indicator’, whereas Professor Dow had merely confirmed that this Index provides an overview of the trend of the share prices of Russian oil and gas companies, without making any statement about the usefulness of the Index for the valuation of Yukos.¹⁷⁷¹ Third, the Tribunal wrongly made it appear as if transposing an asset value over time with the RTS Oil & Gas Index was a method proposed by both parties, when Professor Dow had emphasised during the hearing that he only applied the RTS Oil & Gas Index in his valuations to duplicate and (in)validate Mr Kaczmarek's methods and therefore did not endorse this method in any way.¹⁷⁷²

1097. Therefore, the Tribunal's explanation cannot serve as a basis for its application of the RTS Oil & Gas Index and it has failed to state (sound) reasons for this crucial decision.

¹⁷⁶⁷ See also SoR, § 390.

¹⁷⁶⁸ See Hermes' Expert Opinion (**Exhibit RF-D19**), §§ 87 and 88.

¹⁷⁶⁹ See in particular §§ 911-921.

¹⁷⁷⁰ See also Chapter V.D, §§ 916-921.

¹⁷⁷¹ See also Chapter V.D, §§ 911-912.

¹⁷⁷² See also Chapter V.D, §§ 913-915.

Re (c): failing to apply the deduction on the equity value

1098. As was also explained in chapter V.D,¹⁷⁷³ the Tribunal, in using its own methodology for calculating the damages, failed to take into account the inextricable link between dividend and equity value.
1099. This is because the amount of profit (or cash) generated by a business depends primarily on the operational performance of the business. This profit can then either be distributed as dividends or be kept in the business as equity value. Profits, dividends and equity value are therefore connected. Mr Kaczmarek had also explicitly recognised this connection and had taken it into account in his damage calculations.
1100. The Tribunal ignored this without any explanation and applied a deduction to the dividends, but failed to do the same for the equity value. The Tribunal has failed to state (sound) reasons for this decision.
1101. The Tribunal held that Mr Kaczmarek in his calculations had not or had insufficiently accounted for a number of factors and risks, and that those factors and risks allegedly had a negative influence on the performance and profitability of Yukos.
1102. Subsequently, the Tribunal reduced the dividends to be awarded, in order to account for those factors and risks. However, the Tribunal failed to also apply this deduction to the calculation of the equity value, whereas this was required given the (explicitly recognised) connection between profit, dividend and equity value. If the performance and profitability are lower, as the Tribunal held in respect of Yukos because of the deductions, the enterprise will generate less shareholder value, which not only affects the amount of the dividends, but also the equity value of the enterprise.
1103. Consequently, the Tribunal failed to consistently apply the adjustments it made in the calculation of the dividends to the calculation of the equity value, without stating (sound) reasons for the same. Consequently, the Tribunal has awarded at least USD 1.4 billion in unfounded equity value as damages, as is further explained in chapter V.D¹⁷⁷⁴.

¹⁷⁷³ See in particular §§ 935-946.

¹⁷⁷⁴ See in particular § 946.

1104. Also the Tribunal did not give any explanation for the choice of the relevant factors or to what extent they were influential. That is again a decision without (sound) reasoning.¹⁷⁷⁵

Re (d): failure to compensate the overestimation of the dividends, leading to double counting

1105. Finally, in chapter V.D¹⁷⁷⁶, it is also explained that the Tribunal awarded an amount of over USD 20 billion in damages twice – both as dividend and as equity value, without stating (sound) reasons.¹⁷⁷⁷

1106. Here, too, the Tribunal failed to recognise the connection between profit, dividend and equity value. In his DCF model, Mr Kaczmarek had started from a hypothetical situation in which Yukos distributed all available funds as dividend. Mr Kaczmarek explicitly acknowledged that this was a hypothetical assumption and not a realistic representation of facts:

“As a practical matter, we recognize that not all of the free cash flows to equity generated by YukosSibneft would have been issued as dividends to the shareholders, and a portion of this free cash flow would have been invested in positive net present value (NPV) initiatives such as development of existing properties or acquisition of new properties.”¹⁷⁷⁸

1107. According to Mr Kaczmarek, this unrealistic assumption underlying his method was ultimately not detrimental, as the overestimation of the dividends was compensated with a lower equity value on the basis of the same DCF model:

“However, since our valuation of YukosSibneft does not consider such reinvestments of free cash flows, it is reasonable to assume these free cash flows would have been issued as dividends. Said differently, if a portion of these free cash flows had been invested in positive NPV initiatives in lieu of dividends, then our equity value for YukosSibneft calculated in Section X would have been proportionately higher.”¹⁷⁷⁹

¹⁷⁷⁵ Expert Opinion of Hermes, (**Exhibit RF-D19**), § 64.

¹⁷⁷⁶ See in particular § 935-938 and 947-963.

¹⁷⁷⁷ As professor Dow explains in his Expert Opinion Prof. Dow 2017, no. 40 (**Exhibit RF-D18**). “In my first report I showed that the Tribunal does exactly that indirectly by awarding dividends twice – once as capital gains that assume the dividend was not given and then again as dividends. They do “effectively award the same amounts twice”.”

¹⁷⁷⁸ First Kaczmarek Report (**Exhibit RF-03.1.C-2.1**), § 392, footnote 488. ‘YukosSibneft’ is the designation HVY use to refer to the result of the alleged merger between Yukos and Sibneft – which, incidentally, never actually took place.

¹⁷⁷⁹ First Kaczmarek Report (**Exhibit RF-03.1.C-2.1**), § 392, footnote 488.

UNOFFICIAL TRANSLATION

This text is an unofficial translation of the Dutch original. In case of any discrepancies, the Dutch original shall prevail.

1108. However, the Tribunal constructed its own method of calculating damages, which entailed, among other things, that it calculated the dividends with the DCF model (and took from that the overestimation of the dividends), but for the equity value applied the comparable companies method. However, contrary to the DCF method, the comparable companies method did not contain a mechanism for compensation of the overestimation of the dividends in the calculation of the equity value.¹⁷⁸⁰
1109. The Tribunal failed to recognise this and, without consulting the parties, disconnected its calculation of the dividends (using the DCF method) from the calculation of the equity value (using the comparable companies method). The Tribunal thus upheld the overestimation of the dividends and failed to compensate it in the equity value. As a consequence, the Tribunal awarded an amount of over USD 20 billion twice as damages: once for missed dividends and once for missed equity value. The Tribunal has failed to state any (sound) reasons for this decision.
1110. In addition, as also explained in chapter V.D¹⁷⁸¹, this hypothesis used by the Tribunal – that Yukos would distribute all available assets as dividend – is inconsistent and incompatible with the Tribunal’s use of the RTS Oil & Gas Index. By using this Index to extrapolate Yukos’ equity value from 2007 to 2014, the Tribunal necessarily assumed that the course of the equity value of Yukos would have followed that of the other companies (Yukos’ peers) in the RTS Oil & Gas Index.
1111. If it must be assumed that Yukos had distributed all available funds as dividend, as the Tribunal ruled, this necessarily means that (the growth of) Yukos’ equity value would have lagged behind compared to the other companies in the RTS Oil & Gas Index because companies (including Yukos’ peers) would normally distribute only part of the available funds as dividend and reinvest the remainder, as Mr Kaczmarek had explicitly pointed out.
1112. The fact that the Tribunal awarded Yukos an above-average dividend yield is therefore inconsistent with the Tribunal’s assumption that Yukos’ equity value would have been in line with the RTS Oil & Gas Index – *either* Yukos would have distributed a higher dividend, as a result of which its equity value would have lagged behind the Index, *or* its equity value would have been in line with the Index, in which case Yukos would not have

¹⁷⁸⁰ Expert Opinion of prof. Dow 2017 (**Exhibit RF-D18**), Chapter IV, §§ 24-39.

¹⁷⁸¹ See in particular § 955 et seq.

been able to structurally distribute a higher amount of dividend than its peers in the Index.¹⁷⁸²

1113. Therefore, the Tribunal, without stating (sound) reasons, awarded an amount of over USD 20 billion twice as damages, while the method it used was moreover self-contradictory and inconsistent.

(c) ***Conclusion: the estimate of the amount of the damages by the Tribunal lacks (sound) reasons***

1114. Given the foregoing, the conclusion is inescapable that various essential decisions of the Tribunal in respect of the estimate of the amount of the damages lack (sound) reasons. What is equally harrowing is that the Tribunal – rightly so – had rejected certain calculation proposals of HVY because the Russian Federation did not have the possibility to respond thereto, but itself used calculation methods to which the Russian Federation could not respond to at all. Given the supporting character of this decision on damages for the final decision of the Tribunal, the lack of stating (sound) reasons entails that the Yukos Awards fail to comply with the minimum requirements for reasoning that is required by Article 1057(4)(e) DCCP in conjunction with Article 1065(1)(b) DCCP for an arbitral award and this, too, is grounds for setting aside the Yukos Awards.

D. Reasoning Ground 2 - The Arbitral Tribunal has not stated any sound reasons for its incorrect opinion that the case file does not contain evidence showing that the Mordovian companies of Yukos were sham companies, incorporated solely for the purpose of avoiding Russian taxes

The Russian Federation refers to:		
<u>Arbitrations:</u>		
Final Awards	Chapter VIII.B.5.a	§ 639
<u>Setting aside proceedings:</u>		
Writ	Chapter VII.D	§§ 316 - 324 and 526 - 528
SoD	Part I, Chapter 3.5	§§ I.187 - 190
	Part II, Chapter 4.2	§§ II.638 - 641
SoR	Chapter VI.D	§§ 663 - 697
SoRej	Chapter 5.4	§§ 399 - 410
RF Pleading Notes	Chapter V	§§ 58 - 65
HVY Pleading Notes	Chapter 5	§§ 159 - 161
SoA	-	-
<u>Primary exhibits:</u>		

¹⁷⁸² Expert Opinion of Prof. Dow 2017 (**Exhibit RF-D18**), §§ 25, 31-36, where Professor Dow also emphasises that the combination of the Comparable Companies method for the equity value and the RTS Oil & Gas Index for the missed dividends is nonsense and economically utterly irresponsible.

UNOFFICIAL TRANSLATION

This text is an unofficial translation of the Dutch original. In case of any discrepancies, the Dutch original shall prevail.

<u>Arbitrations:</u>	
RME-255 (RF-03.2.C-2.255)	Transcript of the interrogation of Silayev
RME-256 (RF-03.2.C-2.256)	Transcript of the interrogation of Tsigura
RME-257 (RF-03.2.C-2.257)	Transcripts of several interrogations
RME-258 (RF-03.2.C-2.258)	Transcript of the interrogation of Subbotina
RME-259 (RF-03.2.C-2.259)	Transcript of the interrogation of Varketin
Annex (Merits) C103 (RF-03.2.C-1.103)	Tax report for 2000
RME-345 (RF-03.2.C-2.345)	Tax report for 2001
RME-346	Tax report for 2002
RME-260	Tax report for 2003
RME-3328 (RF-03.2.C-2.3328)	First ECtHR Ruling
RF-03.1.C-2.2.4	First Konnov Report
RF-03.1.C-2.4.2	Second Konnov Report
<u>Setting aside proceedings:</u>	
RF-4	Second ECtHR Ruling

Essence of the argument

- The Tribunal failed to provide a tenable reason with regard to its incorrect and incomprehensible opinion that there was no evidence whatsoever that the Mordovian companies were sham companies (as well):
- Sufficient evidence of the fact that the quasi-independent ‘trading partners’ of Yukos, which have their official seat in Mordovia only on paper and are actually controlled entirely from Moscow by Yukos, has been submitted in the Arbitrations. The Tribunal also referred to this evidence elsewhere in the Final Awards.
- Based on identical evidence for the low-tax regions Lesnoy and Trekhgorny, the Tribunal concluded that tax fraud was committed by Yukos with sham companies in those regions.
- The ECtHR concluded on the basis of the same documents that were submitted to the Tribunal that *all* trading companies – including those Yukos worked with in Mordovia – were sham companies as well.
- The Tribunal has nevertheless used the incomprehensible observation that there was no evidence whatsoever for fraud in Mordovia as a supporting consideration to arrive at the conclusions – which therefore necessitate that the Final Awards be set aside – that:
 - the Russian Federation did not intend to collect taxes but intended to force Yukos into bankruptcy;
 - the measures of the Russian Federation result in a violation of Article 13 ECT;
 - the carve out for taxes of Article 21(1) ECT does not apply, because the

additional tax assessments did not take place in good faith.

(a) **Introduction:**

1115. The Tribunal mainly based the allowance of HVY's claims on its opinion that the tax assessments relating to Yukos' Mordovian companies were not *bona fide*.¹⁷⁸³ These additional assessments approximately concerned 78% of all additional assessments.¹⁷⁸⁴ In this context, the Tribunal held that the Russian Federation has allegedly not advanced any evidence for the fact that Yukos' Mordovian companies were sham companies:

“The Tribunal has not found any evidence in the massive record that would support Respondent's [the Russian Federation] submission that there was a basis for the Russian authorities to conclude that the entities in Mordovia, for example, were shams.”¹⁷⁸⁵

1116. However, the Russian Federation has submitted extensive evidence in the Arbitrations with regard to Yukos' tax evasion through the use of sham companies in Mordovia. As explained below in detail, these Mordovian sham companies had straw men appointed as their directors, had no genuine business activities in the regions, and were controlled entirely by Yukos executives in Moscow.

1117. The Tribunal's conclusion regarding the sham companies in Mordovia is even more incomprehensible, because the evidence of tax fraud in Mordovia was essentially identical to the evidence of the tax fraud which Yukos committed in Lesnoy and Trekhgorny. Indeed, the Tribunal *agreed* with the Russian Federation that the 'trading companies' in Lesnoy and Trekhgorny, fully controlled by Yukos from Moscow, were sham companies and that the use of the tax regimes in those regions was therefore illegal.¹⁷⁸⁶

1118. However, the Tribunal arrived at the incomprehensible conclusion that there is allegedly “*not (...) any evidence*”¹⁷⁸⁷ that the Mordovian companies were sham companies. The

¹⁷⁸³ Final Awards, marginal nos. 639-648 and 1404.

¹⁷⁸⁴ Final Awards, marginal no. 500.

¹⁷⁸⁵ "639. The Tribunal has not found any evidence in the massive record that would support Respondent's [the Russian Federation] submission that there was a basis for the Russian authorities to conclude that the entities in Mordovia, for example, were shams." Emphasis added.

¹⁷⁸⁶ Final Awards, marginal 1611. See also Final Awards, marginal nos. 379-454 and marginal nos. 488-494.

¹⁷⁸⁷ Final Awards, marginal 639.

Tribunal never explains how this could be so, when the same illegal behaviour took place in Mordovia as in Lesnoy and Trekhgorny, as demonstrated by the same types of evidence.

1119. Even more remarkably, the evidence pertaining to Mordovia and the evidence pertaining to Lesnoy and Trekhgorny, in many instances, was contained *in the very same documents* and involved *the very same Yukos executives*. To highlight three extraordinary examples:

- (a) Many documents were submitted to the Tribunal reflecting that Mr. Vladislav N. Kartashov was the general director and chief accountant of several of Yukos's sham companies *in all three jurisdictions*.¹⁷⁸⁸ These included OOO Ratmir (Mordovia), OOO Mitra (Lesnoy), and OOO Kverkus (Trekhgorny)).¹⁷⁸⁹
- (b) In 2001, Mr. Kartashov sent a consolidated chart to Ms. Irina Golub, who was the Chief Accountant of Yukos.¹⁷⁹⁰ This chart showed that Yukos was monitoring legal proceedings against the sham companies in Mordovia (Ratmir and Alta-Trade), simultaneously with similar legal proceedings against sham companies in Lesnoy (Mitra, Business-Oil) and Trekhgorny (Kverkus, Grace).¹⁷⁹¹ This "Kartashov chart" was expressly discussed by counsel for the Russian Federation during the Merits Hearing on 5 November 2012.¹⁷⁹² In the Final Awards, the Tribunal devoted two whole paragraphs to discussing Mr. Kartashov's chart,¹⁷⁹³ but somehow failed to acknowledge any of its references to multiple different Mordovian companies.

¹⁷⁸⁸ See e.g., Explanations of the Interregional Tax Inspectorate of the Russian Federal Tax Service for Major Taxpayers No. 1, in response to Yukos' Cassation Appeal dated 4 May 2005 at 7 (RME-1545); Decision of the Moscow Arbitrazh Court dated 23 December 2004 at 9 (RME-1563); Yukos Evidence Disclosure Application dated 14 May 2004 at 10, 16 (RME-1581) ; Appeal Resolution of the Moscow Arbitrazh Court of 29 June 2004 at 9 (Annex (Merits) C-121); Decision No. 03/1 of the participant of Mitra dated 5 March 2001 at 3 (RME-299).

¹⁷⁸⁹ See Explanations of the Interregional Tax Inspectorate of the Russian Federal Tax Service for Major Taxpayers No. 1, in response to Yukos' Cassation Appeal dated 4 May 2005 at 7 (RME-1545) (identifying Mr. Kartashov's relationship with these companies); Final Awards, marginal no. 278 (listing the regions of the Russian Federation where these companies are located).

¹⁷⁹⁰ Kartashov's E-mail to Golub dated 23 Nov. 2001 (RME-3338); see also Final Awards, marginal nos. 397, 489.

¹⁷⁹¹ Kartashov's E-mail to Golub dated 23 Nov. 2001 (RME-3338).

¹⁷⁹² See e.g. Transcript Hearing on Merits, Day 18, 197:4-12.

¹⁷⁹³ See Final Awards, marginal nos. 397, 489.

- (c) In 2004, several PWC accountants prepared a set of consolidated diagrams regarding the Yukos corporate structure.¹⁷⁹⁴ These diagrams showed parallel connections and parallel revenue streams between the sham companies in Mordovia, Lesnoy, and Trekhgornyy, and Yukos's offshore holding companies. These parallel structures were analyzed extensively by Professor Rosenbloom, particularly in connection with USD 3.6 billion in dividends paid from a Mordovian sham company (OOO Fargoil) to a Cypriot holding company.¹⁷⁹⁵ These same diagrams by PWC show that Yukos also moved parallel revenue streams through essentially identical sham companies based in Lesnoy and Trekhgornyy.¹⁷⁹⁶

1120. These documents demonstrate that Yukos itself considered all of these companies in Mordovia, Lesnoy, and Trekhgornyy to comprise part of a single, integrated, and continuous scheme of corporate tax evasion. No meaningful distinctions were ever drawn between the various groups of companies. It thus makes no sense that the Tribunal could reach opposite conclusions regarding tax evasion in Mordovia and tax evasion in Lesnoy and Trekhgornyy, when the different groups of sham companies were all managed or monitored by *the same Yukos executives* using *the same sets of documents*.

1121. The opinion of the Tribunal about the Mordovian companies is furthermore diametrically opposed to the opinion of two separate divisions of the ECtHR that were both confirmed by the Grand Chamber, which held based on the same documents that all trading companies of Yukos that were formally located in the low-tax regions were "shams".¹⁷⁹⁷ The ECtHR concluded based on the same documents that had been submitted in the Arbitrations that the tax assessments imposed on these companies were legitimate and proportional, and

¹⁷⁹⁴ See PWC Email dated 17 June 2004 (RME-2096); PWC Email dated 24 June 2004 (RME-2097).

¹⁷⁹⁵ See Expert Report Prof. Rosenbloom 2011, §§ 116, 124 and 134.

¹⁷⁹⁶ See PWC Email dated 17 June 2004 (RME-2096); PWC Email dated 24 June 2004 (RME-2097); *also* Expert Report Prof. Rosenbloom 2011, §§ 116, 124 and 134.

¹⁷⁹⁷ First ECtHR Ruling, § 590 (**Exhibit RF-03.2.C-2.3328** and RME-3328) (emphasis added by counsel): "*The conclusions of the domestic courts in the Tax Assessment proceedings 2000-2003 were sound. The factual issues in all of these proceedings were substantially similar and the relevant case files contained abundant witness statements and documentary evidence to support the connections between [Yukos] and its trading companies and to prove the sham nature of the latter entities." See also Second ECtHR Ruling, §§ 786 and 811 (**Exhibit RF-04**). See also Writ, § 318; SoR, § 686; Pleading Notes RF, § 63.*

UNOFFICIAL TRANSLATION

This text is an unofficial translation of the Dutch original. In case of any discrepancies, the Dutch original shall prevail.

were not the result of 'improper motive'.¹⁷⁹⁸ The ECtHR did not draw any distinction between the sham companies based in Mordovia and the sham companies based elsewhere.

1122. The opinion of the Tribunal that there is allegedly no evidence for the fraud in Mordovia is crucial for the next subsequent decisions of the Tribunal, which also support its final judgment:

- the Russian Federation did not intend to collect taxes but intended to force Yukos into bankruptcy.¹⁷⁹⁹
- the measures of the Russian Federation result in a violation of Article 13 ECT (expropriation).¹⁸⁰⁰
- the carve out for taxes and collection measures of Article 21(1) ECT does not apply, because the additional tax assessments did not take place in good faith; the Tribunal has jurisdiction.¹⁸⁰¹

1123. Below, the Russian Federation sets out the essence of its argument in the first instance about this ground for setting aside (failure to give tenable reasons, Article 1065(1)(d) DCCP). Quotes from the testimonies and documents that were submitted in the Arbitrations (and before the ECtHR) have been included in the first instance for that purpose, among other things. As will be demonstrated below with schedules in § 1129 et seq., the arbitration file contains much more evidence about Yukos' tax evasion in Mordovia and the fact that the companies that are formally located there are shams as well. HVY have never substantively contested the evidence about the fraud in Mordovia other than in general terms. HVY do not discuss this ground for setting aside in their statement of appeal.

¹⁷⁹⁸ Writ §§ 56, 344-350 with reference to the First ECtHR Ruling (**Exhibit RF-03.2.C-2.3328** and RME-3328) and the Second ECtHR Ruling (**Exhibit RF-04**).

¹⁷⁹⁹ Final Awards, marginal nos. 756-757, which makes explicit reference to the evidence in regard to Yukos' trading companies discussed in the foregoing.

¹⁸⁰⁰ Final Awards, marginal nos. 1579-1585.

¹⁸⁰¹ Final Awards, marginal nos. 1430-1445.

- (b) *There is an abundance of evidence of the fraud Yukos committed in Mordovia which is furthermore identical to the evidence of the fraud Yukos committed in Lesnoy and Trekhgorny.*

1124. Lower tax rates were used in specific parts of the Russian Federation where the economic development lagged behind. These deviating rules served to promote the local investments and business activities.¹⁸⁰² Yukos systematically abused such arrangements.¹⁸⁰³

1125. Yukos had dozens of sham companies founded in various low-tax regions, appointing straw men who were controlled by Yukos as ‘directors’. These sham companies purchased oil from production companies of Yukos ‘on paper’ against artificially low prices. This oil was subsequently sold on to other sham companies, which were also controlled by Yukos, via complex sham transactions, whereby the price doubled several times within a number of days. The same oil was ultimately sold to third parties at market value. This entire ‘process’ was managed by employees of Yukos in Moscow and the monetary transactions ran via the banks that were controlled by Yukos Oligarchs. This enabled the sham companies to earn enormous profits for which they hardly paid any tax of any kind.¹⁸⁰⁴ These profits would ultimately, via a detour involving companies Yukos also controlled, end up with Yukos and the Yukos Oligarchs.¹⁸⁰⁵ With the help of this construction Yukos evaded billions of dollars in profit tax that should have been paid in the Moscow region, where the economic activities took place.¹⁸⁰⁶

1126. It seemed as if the companies in the low-tax regions were independent entities that were unrelated to the Yukos group. When these companies were founded, Yukos made sure that it was not clear that the companies in question were truly affiliated to Yukos and had been

¹⁸⁰² Final Awards, marginal no. 280.

¹⁸⁰³ See, among others, the following documents from the Arbitrations: Respondent’s Counter-Memorial, §§ 225-308 (**Exhibit RF-03.1.B-3**); Respondent’s Rejoinder, §§ 578-627 (**Exhibit RF-03.1.B-5**) and the expert reports of Konnov (**Exhibit RF-03.1.C-2.2.4** and **Exhibit RF-03.1.C-2.4.2**). See also the first ECtHR Ruling §§ 590-591 (**Exhibit RF-03.2.C-2.3328** and RME-3328) and the second ECtHR Ruling, §§ 786, 811 (**Exhibit RF-04**).

¹⁸⁰⁴ See, among others, the following documents from the Arbitrations: Respondent’s Counter-Memorial, §§ 244-248 (**Exhibit RF-03.1.B-3**); Respondent’s Rejoinder, § 579 (ii)-(iii) (**Exhibit RF-03.1.B-5**); Respondent’s Opening Slides Vol. 1, p. 26-34 (**Exhibit RF-03.2.C-2.111**); Konnov I, §§ 21-22 (**Exhibit RF-03.1.C-2.2.4**); Konnov II, § 6 (**Exhibit RF-03.1.C-2.4.2**); See also Writ, §§ 39, 52; Pleading Notes RF, § 59.

¹⁸⁰⁵ Respondent’s Counter-Memorial, §§ 256-277 (**Exhibit RF-03.1.B-3**). For Mordovia, see e.g. Chart 8 (Fargoil) in § 275.

¹⁸⁰⁶ Writ, § 52.

founded by it. It concerned companies which – in order to limit the risk of discovery – had changing names such as Alta Trade, Ratmir, Mars XXII, Fargoil and Makro-Trade.¹⁸⁰⁷ See chapters III.B(b) and III.B(c) above.

1127. In the late 1990s, sham companies were incorporated particularly in the low-tax regions Lesnoy, Trekhgorny and Kalmykia. However, the authorities in these regions took a rather critical stance towards Yukos' modus operandi. The Yukos Oligarchs therefore moved out to other low-tax regions, such as Mordovia and Evenkia, where the Yukos Oligarchs had a far-reaching political and economic influence.¹⁸⁰⁸

1128. The Russian Federation has submitted a lot of evidence in the Arbitrations which demonstrates that Yukos evaded taxes with sham companies in Mordovia and in other lower tax regions such as Lesnoy as Trekhgorny. The evidence is explained in *Respondent's Counter-Memorial*, *Respondent's Rejoinder*, *Respondent's Opening Presentations* and expert reports of Konnov, Prof. Lys and Gross.¹⁸⁰⁹ In the Setting Aside Proceedings, the Russian Federation has included quotes from witness statements in the Writ and the Reply that have been submitted in the Arbitrations.¹⁸¹⁰ The arbitration file contains much more evidence about Yukos' fraudulent constructions in the low-tax regions than the documents that were referred to in the first instance of the Setting Aside Proceedings.¹⁸¹¹ Quotes from the evidence submitted in the Arbitrations have also been included in Annex 1 to this Defence on Appeal. The Content of Annex 1 (18 pages) is an integral part of the evidence for the statements the Russian Federation defends in this

¹⁸⁰⁷ Final Awards, marginal nos. 327-370; *see also* PWC Email dated 17 June 2004 (RME-2096); PWC Email dated 24 June 2004 (RME-2097).

¹⁸⁰⁸ For instance, the President and the Parliament of the Republic of Mordovia always appointed Yukos representatives to sit on the Russian Federal Council. Between 2001 and 2003, for example, Nevzlin sat on the Federal Council of Russia on behalf of the Republic of Mordovia, *see* RME-262 and RME-2265. It follows from RME-263 and RME-264, among others, that Dubov owes his position in the Duma to the president of the Republic of Mordovia.

¹⁸⁰⁹ See the following documents from the Arbitrations: Respondent's Counter-Memorial, §§ 225-277 (Exhibit **RF-03.1.B-3**); Respondent's Rejoinder, §§ 578-627 (Exhibit **RF-03.1.B-5**); Respondent's Opening Slides Vol. 1, p. 20-23 (**Exhibit RF-03.2.C-2.111**); Konnov I, §§ 12-22 (Exhibit **RF-03.1.C-2.2.4**); Konnov II, § 6 (**Exhibit RF-03.1.C-2.4.2**); First expert opinion of Prof. Lys dated 1 April 2011, §§ 111-141; Second Expert Opinion of Prof. Lys dated 15 August 2012, §§ 102-139; Expert opinion of Gross dated 14 August 2012, §§ 4.5-4.6.

¹⁸¹⁰ Writ § 319; SoR §§ 674-685.

¹⁸¹¹ With regard to the fraud in Mordovia, the Russian Federation points to the straw men Klimantovich, Kolupayeva, Litovchenko, Lyashev, Reva, Sidirova, and Yezhova, among others. The arbitration file also contains more evidence about fraud in the other low-tax regions, for example statements of Yelfimov, Volok, and Vorobyova (*see also* Annex 1).

Defence on Appeal. Thus, all this proof was already submitted in the Arbitrations. The quotes included in Annex 1 clearly and undeniably illustrate Yukos' abuse (in view of, among other things, tax evasion) of the sham companies incorporated by its associates and straw men.

1129. The arbitration documents demonstrate that Yukos committed fraud in the low-tax regions in the following manner:

- (a) Yukos founded dozens of sham companies that exist only 'on paper' and are managed by straw men who – insofar as they are not part of the Yukos group – were often low-skilled or even mentally challenged and had never even heard of the company which they allegedly managed. In most cases, they merely signed documents which they had not read in the back seat of a car or in a bar against payment.¹⁸¹² For example, the founder and general director of Fargoil was Mr. Mikhail N. Silayev, who merely signed documents in the car of an acquaintance in exchange for a USD 200 loan.¹⁸¹³ He never went to Mordovia, and knew nothing about the operations of Fargoil.¹⁸¹⁴
- (b) The sham companies were controlled by Yukos from Moscow.¹⁸¹⁵ For example, the accounts for Fargoil, Ratmir, and Alta Trade were all kept by Yukos executives in Moscow.¹⁸¹⁶ Mr. Kartashov also reported to Ms. Golub regarding legal proceedings against Alta Trade and Ratmir.¹⁸¹⁷ As the

¹⁸¹² See, among others, the following documents from the Arbitrations: Respondent's Counter-Memorial, §§ 237-242 (**Exhibit RF-03.1.B-3**); Respondent's Rejoinder, § 640(iii) (**Exhibit RF-03.1.B-5**); Respondent's Opening Slides Vol. 1, p. 19-25 (**Exhibit RF-03.2.C-2.111**). See also Writ, §319(a); Reply, §§ 674-676.

¹⁸¹³ Transcript of the interrogation of Silayev (**Exhibit RF 03.2.C-2.255** and RME-255), as submitted in the Arbitrations.

¹⁸¹⁴ Ibid.

¹⁸¹⁵ See, among others, the following documents from the Arbitrations: Respondent's Counter-Memorial, § 241 (**Exhibit RF-03.1.B-3**); Respondent's Rejoinder, § 640 (i)(ii) (**Exhibit RF-03.1.B-5**); Respondent's Opening Slides Vol. 1, p. 19-25 (**Exhibit RF-03.2.C-2.111**). See also Writ, § 319(c).

¹⁸¹⁶ Decision to Hold the Taxpayer Fiscally Liable for a Tax Offense No. 14-3-05/1609-1 (April 14, 2004), p. 2, 12, 23, 43, 46 (Annex (Merits) C-104); Decision to Hold the Taxpayer Fiscally Liable for a Tax Offense No. 30-3-15/3 (September 2, 2004), p. 8-9 (Annex (Merits) C-155); Decision to Hold the Taxpayer Fiscally Liable for a Tax Offense No. 52/896 (November 16, 2004), p. 59-60 (Annex (Merits) C-175); Decision to Hold the Taxpayer Fiscally Liable for a Tax Offense No. 52/985 (December 6, 2004), p. 18-19 (Annex (Merits) C-190).

¹⁸¹⁷ Kartashov's E-mail to Golub dated 23 Nov. 2001 (RME-3338).

external auditor for Yukos, PWC was informed of revenues paid by Fargoil in dividends to Yukos' offshore companies.¹⁸¹⁸

- (c) The sham companies had no or virtually no fixed assets or employees of their own and did not perform any actual trading activities in the low-tax regions.¹⁸¹⁹ For example, Fargoil made a profit of over USD 4 billion in 2001-2003, though it had no fixed assets in 2001-2002, two employees in 2001, allegedly had nine employees in 2002, and allegedly had eleven employees in 2003.¹⁸²⁰
- (d) The group structure was continuously changed for no apparent economic reason, whereby the sham companies changed names, merged, relocated their official seat or were 'sold' to various layers of offshore holding companies and trusts on the BVI and Cyprus, among others.¹⁸²¹ For example, two of the Mordovian companies overseen by Mr. Kartashov¹⁸²² had their names changed for no apparent reason. Mercury XXIII was changed to Alta Trade, and Pluton XXVI was changed to Ratmir.¹⁸²³
- (e) There was an enormous imbalance between the tax benefits the sham companies received and the investments that were allegedly made in their name in the low-tax regions.¹⁸²⁴ Altogether, the companies Fargoil, Alta Trade, Ratmir, and the other Mordovian companies received 50 times more

¹⁸¹⁸ See PWC Email dated 17 June 2004 (RME-2096); PWC Email dated 24 June 2004 (RME-2097); also Expert Report Prof. Rosenbloom 2011, §§ 116, 124 and 134..

¹⁸¹⁹ See the following documents from the Arbitrations: Respondent's Counter-Memorial, §§ 249-250 (**Exhibit RF-03.1.B-3**); Respondent's Rejoinder, § 579(i) (**Exhibit RF-03.1.B-5**); Respondent's Opening Slides Vol. 1, p. 19-25 (**Exhibit RF-03.2.C-2.111**). See also Writ, § 319(b); Reply, §§ 677-680.

¹⁸²⁰ Reference to Fargoil's balance sheet in Decision to Hold the Taxpayer Fiscally Liable for a Tax Offense No. 52/896 (November 16, 2004), p. 109 (Annex (Merits) C-175). See also Respondent's Counter-Memorial, footnote 289 (Exhibit RF-03.1.B-3); Writ, § 319(b) and footnote 420; Reply, § 675 and footnote 911.

¹⁸²¹ See the following documents from the Arbitrations: Respondent's Counter-Memorial, § 236, 266-277 (**Exhibit RF-03.1.B-3**); Respondent's Rejoinder, §§ 587-602 (**Exhibit RF-03.1.B-5**); Final Awards, marginal nos. 489 and 511. See also Writ, § 311; Reply, §§ 681-683.

¹⁸²² See Kartashov's E-mail to Golub dated 23 Nov. 2001 (RME-3338); see also Explanations of the Interregional Tax Inspectorate of the Russian Federal Tax Service for Major Taxpayers No. 1, in response to Yukos' Cassation Appeal dated 4 May 2005 at 7 (RME-1545); Decision of the Moscow Arbitrazh Court dated 23 December 2004 at 9 (RME-1563); Yukos Evidence Disclosure Application dated 14 May 2004 at 10, 16 (RME-1581); Appeal Resolution of the Moscow Arbitrazh Court of 29 June 2004 at 9 (Annex (Merits) C-121); Decision No. 03/1 of the participant of Mitra dated 5 March 2001 at 3 (RME-299).

¹⁸²³ Final Awards, marginal nos. 340, 359.

¹⁸²⁴ See the following documents from the Arbitrations: Respondent's Counter-Memorial, §§ 249-255 (**Exhibit RF-03.1.B-3**); Respondent's Rejoinder, § 579(iv) (**Exhibit RF-03.1.B-5**). See also Writ, § 319(d).

in tax benefits (approximately RUR 30 billion) than they allegedly made in investments (approximately RUR 619 million).¹⁸²⁵

- (f) Yukos' own managers and its auditor, PWC, warned for additional tax assessments and criminal prosecution if the constructions used in the low-tax regions would become known to the central Russian tax authorities.¹⁸²⁶ Even though PWC was aware of Mordovian companies within the Yukos structure (such as Fargoil),¹⁸²⁷ it never suggested that these Mordovian companies posed any fewer tax risks than the companies in Lesnoy or Trekhgorny.
- (g) Yukos was worried that the unlawfulness of its 'tax optimisation schemes' would come to light and therefore kept a close eye on the tax audits regarding its sham companies.¹⁸²⁸ Mr. Kartashov's chart is one of many such documents in the record.¹⁸²⁹ As noted above, Mr. Kartashov's chart draws no distinction between the Mordovian companies and the companies in Lesnoy or Trekhgorny.¹⁸³⁰

1130. The evidence that has been submitted in the Arbitrations is presented diagrammatically below. The diagram demonstrates that the evidence about Mordovia is essentially identical

¹⁸²⁵ Tax report 2000 (**Exhibit RF-03.2.C-1.103** and Annex (Merits) C-103). See Respondent's Counter-Memorial, §§ 249-255 and footnotes 311-322 (**Exhibit RF-03.1.B-3**); Writ, § 319(d) and footnote 433.

¹⁸²⁶ See the following documents from the Arbitrations: Respondent's Counter-Memorial, §§ 108, 303, 874, 1020-1021, 1227 (**Exhibit RF-03.1.B-3**); Respondent's Rejoinder, §§ 17-20, 603-612 (**Exhibit RF-03.1.B-5**); Respondent's Opening Slides Vol. 1, p. 93-96 (**Exhibit RF-03.2.C-2.111**); Respondent's Post Hearing Brief, §§ 9-11 (**Exhibit RF-03.1.B-6**); Final Awards, marginal 491, 494; See also Writ, §§ 310-312, 320; Reply, §§ 685-686.

¹⁸²⁷ See PWC Email dated 17 June 2004 (RME-2096); PWC Email dated 24 June 2004 (RME-2097).

¹⁸²⁸ See the following documents from the Arbitrations: Respondent's Counter-Memorial, §§ 281-287 (**Exhibit RF-03.1.B-3**); Respondent's Rejoinder, §§ 595-602 (**Exhibit RF-03.1.B-5**); Respondent's Opening Slides Vol. 1, p. 67-92 (**Exhibit RF-03.2.C-2.111**); Respondent's Post Hearing Brief, §§ 7-21 (**Exhibit RF-03.1.B-6**); Final Awards, marginal nos. 488-490. See also Writ, §§ 310-313; Reply, §§ 681-684.

According to HVY, there were indications that the Russian Federation was aware of the 'legal arrangements' of Yukos in Mordovia, but the Russian Federation had never expressed any objections prior to 2003. Dubov (one of the Yukos Oligarchs and active in politics) allegedly informed the Mordovian and Russian authorities that Yukos used facilities in Mordovia to minimise the taxes (see Rejoinder, § 404). However, during the oral hearing in the Arbitrations, Dubov acknowledged that he never informed the Mordovian and Russian authorities about the illegal aspects of the 'tax optimization scheme' (see Writ, §§ 322-323; Reply, § 691). HVY argue that Dubov never mentioned the fraudulent aspects because he was allegedly not aware of them. (see Rejoinder, § 407). The Russian Federation contests the lack of knowledge on the part of Dubov, since Dubov was among those at the head of the Yukos group.

¹⁸²⁹ Kartashov's E-mail to Golub dated 23 Nov. 2001 (RME-3338).

¹⁸³⁰ Ibid.

to the evidence about Lesnoy and Trekhgorny, where tax fraud did take place according to the Tribunal.

(a) Evidence submitted in the Arbitrations about straw men	
<p>Mordovia¹⁸³¹</p> <p>Statements of:</p> <ul style="list-style-type: none"> - Egorov¹⁸³² - Klimantovich¹⁸³³ - Kolupayeva¹⁸³⁴ - Litovchenko¹⁸³⁵ - Lyashev¹⁸³⁶ - Reva¹⁸³⁷ - Silayev¹⁸³⁸ - Tsigura¹⁸³⁹ - Yezhova¹⁸⁴⁰ - Zhukova¹⁸⁴¹ 	<p>Lesnoy and Trekhgorny</p> <p>Statements of:</p> <ul style="list-style-type: none"> - Spirichev¹⁸⁴² - Varketin¹⁸⁴³

¹⁸³¹ The arbitration file also contains more evidence about fraud in the other low-tax regions, such as Evenkia and Kalmykia, for example statements of Yelfimov, Volok, and Vorobyova (see also Annex 1).

¹⁸³² Formal director of Macro Trade (Mordovia). Transcript of the interrogation of Egorov, as included in Russian tax authorities' response to Yukos' appeal in cassation, p. 13-15 (**Exhibit RF-03.2.C-2.257** and RME-257). See also Respondent's Counter-Memorial, footnote 296 (**Exhibit RF-03.1.B-3**); Respondent's Opening Slides Vol. 1, p. 21 (**Exhibit RF-03.2.C-2.111**); Writ, § 319(a) and footnote 414.

¹⁸³³ Formal director of A-Trust (Moscow). A-Trust was the co-founder of Alta Trade (Mordovia) and co-founder and co-shareholder of Yu-Mordovia. Transcript of the interrogation of Klimantovich, as included in the Russian tax authorities' response to Yukos' appeal in cassation, p. 16 (**Exhibit RF-03.2.C-2.257** and RME-257).

¹⁸³⁴ Formal director of Sonata (Moscow). Sonata was the co-founder of Ratmir (Mordovia) and co-founder and co-shareholder of Yu-Mordovia. Description of the statement of Kolupayeva, as included in Russian tax authorities' response to Yukos' appeal in cassation, p. 16 (**Exhibit RF-03.2.C-2.257** and RME-257).

¹⁸³⁵ Representative of a trading partner. Tax Report for 2001, p. 10 (**Exhibit RF-03.2.C-2.345** and RME-345).

¹⁸³⁶ Formal director of Yukos-M (Mordovia). Transcript of the interrogation of Lyashev, as included in Russian tax authorities' response to Yukos' appeal in cassation, p. 16 (**Exhibit RF-03.2.C-2.257** and RME-257).

¹⁸³⁷ Formal director of Sibirskaya (Kalmykia) and Macro Trade (Mordovia). Transcript of the interrogation of Reva as included in Russian tax authorities' response to Yukos' appeal in cassation, p. 11-13 (**Exhibit RF-03.2.C-2.257** and RME-257).

¹⁸³⁸ Formal director and founder of Fargoil (Mordovia). Transcript of the interrogation of Silayev Exhibit **RF-03.2.C-2.255** and RME-255). See also Respondent's Counter-Memorial, footnote 295 (**Exhibit RF-03.1.B-3**); Respondent's Opening Slides Vol. 1, p. 22 (**Exhibit RF-03.2.C-2.111**); Final Awards, marginal 345; Writ, § 319(a) and footnote 415; SoR, § 678 and footnote 928.

¹⁸³⁹ Formal director of Mars XXII (Mordovia). Transcript of the interrogation of Tsigura (**Exhibit RF-03.2.C-2.256** and RME-256). See also Respondent's Counter-Memorial, footnote 296 (**Exhibit RF-03.1.B-3**); Respondent's Rejoinder, footnote 8 (**Exhibit RF-03.1.B-5**); Writ, § 319(a) and footnote 413; SoR, § 678 and footnote 926.

¹⁸⁴⁰ Formal director the company Stekloprommash (Moscow). Stekloprommash was the co-founder and co-shareholder of Yu-Mordovia. Transcript of the interrogation of Yezhova, as included in Russian tax authorities' response to Yukos' appeal in cassation, p. 16 (**Exhibit RF-03.2.C-2.257** and RME-257).

(b) Evidence submitted in the Arbitrations about control exercised by Yukos from Moscow	
<p>Mordovia</p> <p>Statements of:</p> <ul style="list-style-type: none"> - Gavrilina¹⁸⁴⁴ - Subbotina¹⁸⁴⁵ - Sutyaginsky¹⁸⁴⁶ <p>The accounts of Alta Trade, Fargoil, Macro Trade, Mars XXII, Yukos-M, Ratmir and Yu-Mordovia were kept by Yukos companies in Moscow.¹⁸⁴⁷</p>	<p>Lesnoy and Trekhgorny</p> <p>Statement of:</p> <ul style="list-style-type: none"> - Spirichev¹⁸⁴⁸ <p>The administration of Business Oil was kept in Moscow.¹⁸⁴⁹</p>

- ¹⁸⁴¹ Formal director and founder of Mega-Alliance (Baikonur) and Macro Trade (Mordovia). Transcript of the interrogation of Zhukova, as included in Russian tax authorities' response to Yukos' appeal in cassation, p. 15-16 (**Exhibit RF-03.2.C-2.257** and RME-257). See also Respondent's Counter-Memorial, footnote 296 (**Exhibit RF-03.1.B-3**); Respondent's Rejoinder, footnote 970 (**Exhibit RF-03.1.B-5**); Respondent's Opening Slides Vol. 1, p. 20 (**Exhibit RF-03.2.C-2.111**); Final Awards, marginal 351; Writ, § 319(a) and footnote 412; SoR, § 678 and footnote 925. According to HV&, the Tribunal has taken into account evidence about the alleged fraudulent nature of the Mordovian trading shells. In that context, HVY point to the statement of Zhukova. Zhukova stated that she had never heard of Macro Trade and had not founded the company. She had never even been to Mordovia before. In addition, she stated that her passport had been stolen and had later been returned. The Tribunal held that the lawyer of HVY pointed out during an interrogation that Macro Trade had been founded two years after Zhukova's passport had been stolen. According to HVY, this means that there is no lack of grounds (see SoRej., §§ 406-408). HVY oversimplifies things. The moment of foundation of Macro Trade is irrelevant. It is incomprehensible that the Tribunal could arrive at the conclusion that there was no evidence of the fraud in Mordovia whatsoever, whereas the arbitration file contains much more similar statements of dummy directors who testified that they did not know the company that they were directing 'on paper'.
- ¹⁸⁴² Formal director of Business Oil, Mitra and Vald Oil (Lesnoy) Statement of the authorities about Business Oil for 1999 and 2000 (Exhibit RF **RF-03.2.C-2.295** and RME-295). See also Respondent's Counter-Memorial, §§ 282, 678 and footnote 351 (**Exhibit RF-03.1.B-3**); SoR, § 677 and footnote 923.
- ¹⁸⁴³ Formal director of Investproekt (Lesnoy and Trekhgorny). Transcript of the interrogation of Varketin (**Exhibit RF -03.2.C-2.259** and RME-259). See also Respondent's Counter-Memorial, footnote 298 and 358 (**Exhibit RF-03.1.B-3**); SoR, § 677 and footnote 924.
- ¹⁸⁴⁴ Formal director of Yu-Mordovia (Mordovia). Transcript of the interrogation of Gavrilina, as included in Russian tax authorities' response to Yukos' appeal in cassation, p. 16 (**Exhibit RF-03.2.C-2.257** and RME-257). See also Respondent's Counter-Memorial, footnote 297 (**Exhibit RF-03.1.B-3**); Respondent's Rejoinder, footnote 970 (**Exhibit RF-03.1.B-5**); Respondent's Opening Slides Vol. 1, p. 23 (**Exhibit RF-03.2.C-2.111**); Writ, § 319(c) and footnotes 428-429; SoR, § 675 and footnotes 915-916.
- ¹⁸⁴⁵ Formal director of Mars XXII (Mordovia). Transcript of the interrogation of Subbotina (**Exhibit RF -03.2.C-2.258** and RME-258). See also Respondent's Counter-Memorial, footnote 297 (**Exhibit RF-03.1.B-3**); Respondent's Rejoinder, footnotes 8 and 970 (**Exhibit RF-03.1.B-5**); Respondent's Opening Slides Vol. 1, p. 20 (**Exhibit RF-03.2.C-2.111**); Final Awards, marginal 354; Writ, § 319(a) and footnote 426; SoR, § 675 and footnote 913.
- ¹⁸⁴⁶ Representative of a trading partner. Transcript of the interrogation of Sutyaginsky as included in Russian tax authorities' response to Yukos' appeal in cassation, p. 11 (**Exhibit RF-03.2.C-2.257** and RME-257). See also Respondent's Opening Slides Vol. 1, p. 20 (**Exhibit e RF-03.2.C-2.111**); Writ, § 319(c) and footnote 430; SoR, § 675 and footnote 910.
- ¹⁸⁴⁷ Decision to Hold the Taxpayer Fiscally Liable for a Tax Offense No. 14-3-05/1609-1 (April 14, 2004), p. 2, 12, 23, 43, 46 (Annex (Merits) C-104); Decision to Hold the Taxpayer Fiscally Liable for a Tax Offense No. 30-3-15/3 (September 2, 2004), p. 8-9 (Annex (Merits) C-155); Decision to Hold the Taxpayer Fiscally Liable for a Tax Offense No. 52/896 (November 16, 2004), p. 59-60 (Annex (Merits) C-175); Decision to Hold the Taxpayer Fiscally Liable for a Tax Offense No. 52/985 (December 6,

(c) Evidence submitted in the Arbitrations about lack of assets and employees**Mordovia**

Alta Trade made a profit of USD 250 million in 2000-2003, though it had no fixed assets in 2000, a computer and a printer in 2001, fixed assets with a value of less than USD 800 in 2002-2003 and on average two employees in 2001-2003 who partly lived in Moscow.¹⁸⁵⁰

Energotrade (previously Mars XXII) made a profit of over USD 1 billion in 2000-2003, though it had no fixed assets in 2000, 2001 and 2003 and only a single employee in 2001.¹⁸⁵¹

Fargoil made a profit of over USD 4 billion in 2001-2003, though it had no fixed assets in 2001-2002, two employees in 2001, nine employees in 2002 and eleven employees in 2003.¹⁸⁵²

Macro Trade made a profit of over USD 75 million in 2003, but had only a computer, a printer and office supplies as fixed assets in 2003 and no employees in 2001-2002, two employees in 2003.¹⁸⁵³

Lesnoy and Trekhgorny

Business Oil made a profit of over USD 126 million in 1999, but had only four computers and four printers as fixed assets and six employees.¹⁸⁵⁷

Forest Oil had three computers and three printers as fixed assets and six employees.¹⁸⁵⁸

Mitra made a profit of over USD 3 million in 2000 but had only: three computers, a printer and a car and seven employees.¹⁸⁵⁹

Vald Oil made a profit of over USD 37 million in 2000, but had no fixed assets and only three employees.¹⁸⁶⁰

2004), p. 18-19 (Annex (Merits) C-190). See also Respondent's Counter-Memorial, § 241 and footnote 294 (**Exhibit RF-03.1.B-3**); Respondent's Rejoinder, § 640 and footnote 968 (**Exhibit RF-03.1.B-5**); Final Awards, marginal nos. 340-371; Writ, § 319(c) and footnote 432; SoR, § 675 and footnote 918.

¹⁸⁴⁸ Formal director of Business Oil, Mitra and Vald Oil (Lesnoy) and resided in Moscow. Statement of the authorities about Business Oil for 1999 and 2000 (Exhibit RF **RF-03.2.C-2.295** and RME-295). See also Respondent's Counter-Memorial, § 282 and footnote 351 (**Exhibit RF-03.1.B-3**).

¹⁸⁴⁹ Statement of the authorities about Business Oil for 1999 and 2000 (Exhibit RF **RF-03.2.C-2.295** and RME-295). See also Respondent's Counter-Memorial, § 282 and footnote 351 (**Exhibit RF-03.1.B-3**).

¹⁸⁵⁰ Reference to Alta Trade's balance sheet in Decision to Hold the Taxpayer Fiscally Liable for a Tax Offense No. 52/985 (December 6, 2004), p. 55 (Annex (Merits) C-190); tax report over 2000, p. 36 (Annex (Merits) C-103); tax report over 2001, p. 49 (RME-345); tax report over 2002, p. 106 (RME-346); tax report over 2003, p. 76 (RME-260). See Final Awards, marginal 343; Writ, § 319(b) and footnotes 416-418.

¹⁸⁵¹ Reference to Energotrade's balance sheet in Decision to Hold the Taxpayer Fiscally Liable for a Tax Offense No. 52/985 (December 6, 2004), p. 83 (Annex (Merits) C-190); tax report over 2000, p. 23 (Annex (Merits) C-103); tax report over 2001, p. 101 (RME-345); tax report over 2003, p. 116 (RME-260). See also Respondent's Counter-Memorial, § 250 and footnote 312 (**Exhibit RF-03.1.B-3**); Writ, § 319(b) and footnotes 423-424; SoR, § 675, 678 and footnotes 914, 927.

¹⁸⁵² Reference to Fargoil's balance sheet in Decision to Hold the Taxpayer Fiscally Liable for a Tax Offense No. 52/986 (November 16, 2004), p. 109 (Annex (Merits) C-175). See also Respondent's Counter-Memorial, footnote 289 (**Exhibit RF-03.1.B-3**); Writ, § 319(b) and footnote 420; SoR, § 675 and footnote 911.

¹⁸⁵³ Reference to Macro Trade's balance sheet in Decision to Hold the Taxpayer Fiscally Liable for a Tax Offense No. 52/985 (December 6, 2004), p. -96 (Annex (Merits) C-190); tax report over 2001, p. 92 (RME-345); tax report over 2002, p. 130 (RME-346); tax report over 2003, p. 101 (RME-260); tax report about Fargoil, p. 7 (Annex (Merits) C-1124).. See also Respondent's Counter-Memorial, §§ 249-250 and footnotes 310-312 (**Exhibit RF-03.1.B-3**); Writ, § 319(b) and footnotes 421-422; SoR, § 675 and footnote 919.

UNOFFICIAL TRANSLATION

This text is an unofficial translation of the Dutch original. In case of any discrepancies, the Dutch original shall prevail.

Ratmir made a profit of over USD 2 billion in 2000-2003 but had fixed assets of less than USD 800 in 2000-2003 and two to three employees in 2000-2003 who lived in Moskou.¹⁸⁵⁴

Yukos-M made a profit of over USD 2 billion in 2000-2003, but had no fixed assets in 2000, fixed assets with a value less than USD 100 in 2001-2003 and on average four employees in 2000-2003.¹⁸⁵⁵

Yu-Mordovia made a profit of over USD 1 billion in 2000-2003, but had no fixed assets in 2000, a computer in 2001, fixed assets with a value of less than USD 400 in 2003 and on average two employees in 2000 and 2003.¹⁸⁵⁶

(d) Evidence submitted in the Arbitrations about the needlessly complicated group structure

Mordovia

Name change:

- Alta Trade was first Mercury XXIII.¹⁸⁶¹
- Energotrade was first Mars XXII.¹⁸⁶²
- Ratmir was first Pluton XXVI.¹⁸⁶³

Lesnoy and Trekhgorny

In 2001, the sham companies from Lesnoy and Trekhgorny ultimately merged with Investproekt, with its registered office in Kirov and later to Chita, via a complicated restructuring.¹⁸⁶⁹

Forest Oil, Mitra, Vald Oil, Greis, Kolrein, Kverkus,

¹⁸⁵⁷ Memorandum further to the audit in 1999 (**Exhibit RF-03.2.C-2.294** and RME-294); statement about Business-Oil, p. 9 (RME-295). See also Respondent's Counter-Memorial, §§ 281-283 and footnotes 349-355 (**Exhibit RF-03.1.B-3**).

¹⁸⁵⁸ Memorandum further to the audit in 1999 (**Exhibit RF-03.2.C-2.294** and RME-294); statement about Forest-Oil (RME-296). See also Respondent's Counter-Memorial, §§ 281-283 and footnotes 349-355 (**Exhibit RF-03.1.B-3**).

¹⁸⁵⁹ Memorandum further to the audit in 1999 (**Exhibit RF-03.2.C-2.294** and RME-294); tax report for 2000, p. 82-86 (Annex (Merits) C-103). See also Respondent's Counter-Memorial, §§ 281-283 and footnotes 349-355 (**Exhibit RF-03.1.B-3**).

¹⁸⁶⁰ Memorandum further to the audit in 1999 (**Exhibit RF-03.2.C-2.294** and RME-294); tax report for 2000, p. 88-93 (Annex (Merits) C-103). See also Respondent's Counter-Memorial, §§ 281-283 and footnotes 349-355 (**Exhibit RF-03.1.B-3**).

¹⁸⁵⁴ Reference to Ratmir's balance sheet in Decision to Hold the Taxpayer Fiscally Liable for a Tax Offense No. 52/985 (December 6, 2004), p. 60 (Annex (Merits) C-190); tax report over 2000, p. 56 (Annex (Merits) C-103); tax report over 2001, p. 39 (RME-345); tax report over 2002, p. 110 (RME-346); tax report over 2003, p. (RME-260). See also Respondent's Counter-Memorial, § 249 and footnote 310 (**Exhibit RF-03.1.B-3**), Final Awards, marginal 363.

¹⁸⁵⁵ Reference to Yukos-M's balance sheet in Decision to Hold the Taxpayer Fiscally Liable for a Tax Offense No. 52/985 (December 6, 2004), p. 48 (Annex (Merits) C-190).

¹⁸⁵⁶ Reference to Yu-Mordovia's balance sheet in Decision to Hold the Taxpayer Fiscally Liable for a Tax Offense No. 52/985 (December 6, 2004), p. 43 (Annex (Merits) C-190); tax report over 2000, p. 45 (Annex (Merits) C-103); tax report over 2001, p. 55 (RME-345); tax report over 2002, p. 102 (RME-346); tax report over 2003, p. 66 (RME-260). See also Writ § 319(b) and footnote 425.

¹⁸⁶¹ Final Awards, marginal no. 340.

¹⁸⁶² Final Awards, marginal no. 354.

¹⁸⁶³ Final Awards, marginal no. 359.

<p>Fargoil was held by a Cypriot company which in turn was held by various layers of BVI companies and a trust.¹⁸⁶⁴ There were similar¹⁸⁶⁵ complex structures for Energotrade¹⁸⁶⁶ and Macro Trade as well.¹⁸⁶⁷</p> <p>Yukos' financial statements do not report anything on the sham companies in the low-tax regions in the offshore companies.¹⁸⁶⁸</p>	<p>Flander, Muskron, Business Oil and Nortex were indirectly held by various layers of Cypriot companies, a BVI company and a trust.¹⁸⁷⁰</p>
<p>(e) Evidence submitted in the Arbitrations about imbalance between tax benefits and investments</p>	
<p>Mordovia</p> <ul style="list-style-type: none"> - the investments amounted to a very small percentage of the tax benefits that are enjoyed: <ul style="list-style-type: none"> - 0.8% in 2001. - 2% in 2002-2003.¹⁸⁷¹ - Alta Trade, Energotrade, Fargoil, Makro Trade, Ratmir, Yukos-M and Yu-Mordovia invested RUR 619,450,000 and received RUR 30,309,232,595.¹⁸⁷² 	<p>Lesnoy and Trekhgorny</p> <ul style="list-style-type: none"> - the investments roughly amounted to the same small percentage of the enjoyed tax benefits as in Mordovia: <ul style="list-style-type: none"> - 1.12% in 1999.¹⁸⁷³ - Nortex (Trekhgorny) invested RUR 199,071 and received RUR 3,152,537,572; Vald Oil (Lesnoy) invested RUR 73,130,225 and received RUR 1,244,413,717; Business Oil invested RUR 17,455,322 and received RUR

¹⁸⁶⁹ Respondent's Counter-Memorial, §§ 285-286 (**Exhibit RF-03.1.B-3**); Respondent's Rejoinder, §§ 595-602 (**Exhibit RF-03.1.B-5**); SoR, § 681.

¹⁸⁶⁴ The interrogation of Yukos' own auditor, Mr Miller of PwC (RME-17, RME-137, RME-140, RME-353); First expert opinion of Prof. Lys dated 1 April 2011, §§ 111-141; Second expert opinion of Prof. Lys dated 15 August 2012, §§ 102-139. See also Respondent's Counter-Memorial, §§ 266-277 (**Exhibit RF-03.1.B-3**); Respondent's Rejoinder, §§ 587-594 and Chart 2 and 3 (**Exhibit RF-03.1.B-5**). HVY wrongly conclude that no extensive evidence was submitted which demonstrates that Yukos tried to conceal its relationship with the Mordovian companies by raising a complex and often changing offshore construction because the Russian Federation only refers to a single paragraph in Respondent's Rejoinder (see Rejoinder, § 405) in footnote 934.

¹⁸⁶⁵ Respondent's Counter-Memorial (**Exhibit RF-03.1.B-3**) footnote 331: "*A practical illustration of these abuses involved OOO Ratibor ("Ratibor") and OOO Fargoil ("Fargoil"), two of the trading shells that Yukos used in furtherance of its tax evasion scheme.*" See also Respondent's Rejoinder (**Exhibit RF-03.1.B-5**) footnote 875: "*These charts [concerning Fargoil and Ratibor – counsel] are not intended to show in an exhaustive manner the ownership structure of all the trading shells used by Yukos to further its tax evasion scheme. These additional entities included (...) OOO Mars XXII ("Mars XXII") (renamed to Energotrade), (...) Alta Trade, (...) Ratmir, (...) Yu-Mordovia, (g) Yukos-M, (...) OOO Macro-Trade ("Macro-Trade") and footnote 876: "The names of the remaining 18 trading shells used in 2000-2003 not only did not even arguably hint at ties to Yukos, but they signalled the absence of any such ties. These 18 entities include (...) Mars XXII (renamed to Energotrade), (...) Alta Trade, (...) Ratmir."*

¹⁸⁶⁶ First expert opinion of Professor Lys dated 1 April 2011, Appendix D.

¹⁸⁶⁷ Annex to the e-mail of Zaitsev (PwC) to Zubkov dated 24 June 2004, p. 7 (RME-2097) and the annex to the PwC memorandum dated 10 April 2003 (RME-349 and RME-2099).

¹⁸⁶⁸ Gross Expert opinion dated 14 August 2012, §§ 4.5-4.6.

¹⁸⁷⁰ Respondent's Rejoinder, §§ 590, 593 (Chart 1) and footnote 566 (**Exhibit RF-03.1.B-5**).

¹⁸⁷¹ Tax report 2000 (**Exhibit RF-03.2.C-1.103** and Annex (Merits) C-103). See Respondent's Counter-Memorial, §§ 249-255 and footnotes 311-322 (**Exhibit RF-03.1.B-3**); Writ, § 319(d) and footnote 433.

¹⁸⁷² Idem.

¹⁸⁷³ Tax report 2000 (**Exhibit RF-03.2.C-1.103** and Annex (Merits) C-103). See Respondent's Counter-Memorial, § 359 and footnote 476 (**Exhibit RF-03.1.B-3**); Writ, § 319(d) and footnote 434.

	1,549,359,853 ¹⁸⁷⁴
(f) Evidence submitted in the Arbitrations about warnings by Yukos' own managers and accountant	
<p>No distinction between Mordovia, Lesnoy and Trekhgorny</p> <ul style="list-style-type: none"> - Memorandum of Yukos' manager Maly to Yukos' vice president and director of the Corporate Finance Department Sheyko dated 22 April 2002.¹⁸⁷⁵ - Fax from Kuznetsova (Yukos' accountant PwC) to Wilson (PwC) dated 23 July 2002.¹⁸⁷⁶ - Memorandum of Yukos' manager Maly to Yukos' CFO Misamore dated 7 August 2002.¹⁸⁷⁷ - E-mail from Yukos' CEO Khodorkovski to Yukos' president and director of the Corporate Finance Department Sheyko dated 20 February 2003.¹⁸⁷⁸ 	<p>Lesnoy and Trekhgorny</p> <ul style="list-style-type: none"> - Letter from Yukos' vice president and head of the Legal Department Aleksanyan at the head of Golub's accounting department dated 14 December 2001.¹⁸⁷⁹ - E-mail from Maruev to Barbarovich (Yukos' cash management) and Zhuravlev (Yukos' financial department) dated 15 March 2002.¹⁸⁸⁰
(g) Evidence submitted in the Arbitrations about concerns at Yukos about tax constructions	
<p>No distinction between Mordovia, Lesnoy and Trekhgorny</p> <ul style="list-style-type: none"> - E-mail of the manager of the sham companies Kartashov to the head of Golub's accounting department dated 23 November 2001.¹⁸⁸¹ - E-mail from Maruev to Gareeva dated 5 September 2000.¹⁸⁸² 	<p>Lesnoy and Trekhgorny</p> <ul style="list-style-type: none"> - Restructuring operations in 2000 and 2001 without economic reasons further to audit reports and memoranda of the tax authorities about the use of sham companies.¹⁸⁸³

1131. HVY have never substantively and concretely contested the evidence about the fraud in Mordovia; neither in the Arbitrations, nor in the proceedings before the ECtHR, nor in the Setting Aside Proceedings. For example, HVY have not advanced a defence against (i) the witness statements of straw men who had never heard of the Mordovian companies they allegedly founded, (ii) the evidence about the control by Yukos from Moscow, (iii) the statement that the Mordovian sham companies virtually had no fixed asset or employees and (iv) the imbalance between investments in Mordovia and the enjoyed tax benefits.

¹⁸⁷⁴ Idem.

¹⁸⁷⁵ RME-184, § 2.

¹⁸⁷⁶ RME-1477, p. 133-134.

¹⁸⁷⁷ RME-3245 and RME-3342.

¹⁸⁷⁸ RME-3611.

¹⁸⁷⁹ RME-3244.

¹⁸⁸⁰ RME-4040.

¹⁸⁸¹ RME-3338.

¹⁸⁸² RME-3200.

¹⁸⁸³ *Inter alia* RME-294 and RME-3182.

1132. The Tribunal nevertheless ruled that “*not ... any evidence*”¹⁸⁸⁴ was submitted about the Mordovian companies being sham companies.

(c) ***The opinion of the Tribunal is incomprehensible and unsubstantiated***

1133. The opinion of the Tribunal about the lack of evidence (“*not ... any evidence*”¹⁸⁸⁵) with regard to the Mordovian companies being sham companies is incomprehensible and does not hold (or can be equated with an entirely unsubstantiated crucial opinion that supports the outcome of the judgment) for the following reasons:

- (a) In the Arbitrations the Russian Federation has submitted extensive evidence regarding the fact that the Mordovian companies are sham companies (see § 1127-1130 above).

According to its considerations in the Final Awards, the Tribunal also inspected the submitted evidence. The Tribunal concluded that, among other things, (i) several Mordovian companies, including Ratmir, had no fixed assets on their balance sheets and had no storage facilities for oil;¹⁸⁸⁶ (ii) the accounts and finances of the Mordovian companies such as Alta Trade, Fargoil, Mars XXII, Yukos-M and Ratmir were kept by Yukos in Moscow;¹⁸⁸⁷ (iii) straw men were used at, among others, Mars XXII and Macro Trade;¹⁸⁸⁸ (iv) no evidence was submitted that would show that the Mordovian companies actually carried out economic activities, while HVY no doubt would have produced it if any such evidence existed¹⁸⁸⁹ and (v) the most senior managers of Yukos knew that these parts of the tax structure of Yukos – including its Mordovian structures – were ‘vulnerable’ and could have led to huge additional tax assessments, fines and even criminal prosecution.¹⁸⁹⁰

¹⁸⁸⁴ Final Awards, marginal 639.

¹⁸⁸⁵ Final Awards, marginal 639.

¹⁸⁸⁶ Final Awards, marginal 362.

¹⁸⁸⁷ Final Awards, marginal nos. 343, 346, 360, 363 and 365. Cf. SoR, paragraph 675.

¹⁸⁸⁸ Final Awards, marginal no. 354.

¹⁸⁸⁹ Final Awards, marginal no. 648.

¹⁸⁹⁰ Final Awards, marginal nos. 491, 494 and 513.

- (b) The evidence of fraud in Mordovia as was already submitted in the Arbitrations is essentially identical to the submitted evidence of the fraud in Lesnoy and Trekhgorny (see § 1130 above).¹⁸⁹¹
- (c) In many instances, the evidence of tax fraud in Mordovia is actually presented in the same documents as the evidence of tax fraud in Lesnoy and Trekhgorny. This is starkly illustrated by the fact that Mr. Kartashov served as general director for companies in *all three jurisdictions*.¹⁸⁹² Notably, Mr. Kartashov emailed the Chief Accountant of Yukos, Ms. Golub, to discuss legal proceedings commenced against Mordovian sham companies, as well as other sham companies used in Yukos's tax evasion scheme.¹⁸⁹³ Moreover, in its comprehensive analysis of Yukos revenue streams, PWC included dividends paid by Mordovian companies (such as Fargoil) together with dividends paid by companies in Lesnoy and Trekhgorny.¹⁸⁹⁴ Such evidence demonstrates that the Mordovian companies were part of a single, integrated scheme of tax evasion, together with the sham companies in other jurisdictions.

1134. The Russian Federation again emphasizes that the Tribunal has not held that the evidence submitted by the Russian Federation regarding the Mordovian trading companies was insufficiently convincing. The Russian Federation does not complain about the valuation of the evidence – which is mostly discretionary – but rather about the fact that the Tribunal completely ignored the abundance of evidence (“*not ... any evidence*”¹⁸⁹⁵) that the Russian Federation has undisputedly submitted in this regard, which the Tribunal *does* refer to and acknowledge as being relevant elsewhere in the Final Awards.¹⁸⁹⁶ Indeed, it is remarkable

¹⁸⁹¹ Writ § 318; SoR §§ 672-686.

¹⁸⁹² See e.g., Explanations of the Interregional Tax Inspectorate of the Russian Federal Tax Service for Major Taxpayers No. 1, in response to Yukos' Cassation Appeal dated 4 May 2005 at 7 (RME-1545); Decision of the Moscow Arbitrazh Court dated 23 December 2004 at 9 (RME-1563); Yukos Evidence Disclosure Application dated 14 May 2004 at 10, 16 (RME-1581); Appeal Resolution of the Moscow Arbitrazh Court of 29 June 2004 at 9 (Annex (Merits) C-121); Decision No. 03/1 of the participant of Mitra dated 5 March 2001 at 3 (RME-299).

¹⁸⁹³ Kartashov's E-mail to Golub dated 23 Nov. 2001 (RME-3338).

¹⁸⁹⁴ See PWC Email dated 17 June 2004 (RME-2096); PWC Email dated 24 June 2004 (RME-2097).

¹⁸⁹⁵ Final Awards, marginal 639.

¹⁸⁹⁶ Reply, §§ 669, 687-689. AS HVY admit themselves, the Tribunal itself has not stated that it has taken the evidence into account (see Rejoinder footnote 629) but HVY wrongly conclude this based on incorrect assumptions. The Tribunal has not stated anywhere that the evidence regarding Mordovia was unconvincing. It maintained that there was no evidence to conclude that the Mordovian companies were trading shells, wrongly so as demonstrated by this chapter.

that the Tribunal wrote at length about Mr. Kartashov's chart in its Final Awards,¹⁸⁹⁷ but failed to notice the references therein to Mordovian companies, such as Alta Trade and Ratmir.¹⁸⁹⁸

1135. The Tribunal has therefore – either intentionally or not – completely ignored all the undeniable and abundant evidence about the fraud in Mordovia. Most fundamentally, the Final Awards fail to substantiate in any way why the exact same evidence regarding Lesnoy and Trekhgorny is convincing but not with regard to Mordovia.¹⁸⁹⁹ Despite the significance of that evidence as an important basis for the Tribunal's conclusion that, in essence, the additional assessments in respect of Yukos were largely unfounded and spurious, the Tribunal proceeded without any real explanation for its conclusion on this significant issue.¹⁹⁰⁰ This difference with regard to this cardinal point is so significant and incomprehensible that, by challenging this opinion on the basis of the highly marginal 'Nannini' criterion¹⁹⁰¹, the Court of Appeal will in no way violate the great restraint that must be observed by the regular court when applying the ground for setting aside of Article 1065(1)(d) DCCP. Conclusion: an abundance of evidence, no tenable reason

(d) ***Conclusion: an abundance of evidence, no tenable reason***

1136. The Tribunal explicitly held that it had “*not found any evidence in the massive record*”,¹⁹⁰² to justify the conclusion that the companies in Mordovia were sham companies. This consideration also supports the Tribunal's final judgment regarding expropriation. This Court of Appeal can decide the case simply due to lack of any reasons. This Court of Appeal's review of the arbitral case file will reveal substantial evidence that demonstrates that the Mordovian companies are sham companies (which even HVY do not deny), and as such this concerns a lack of a tenable reason regarding an essential aspect of the case. After all, the consideration that the case file contains no evidence for the statement that Yukos

¹⁸⁹⁷ See Final Awards, marginal nos. 397, 489.

¹⁸⁹⁸ Kartashov's E-mail to Golub dated 23 Nov. 2001 (RME-3338).

¹⁸⁹⁹ Writ, § 526; Reply, § 664

¹⁹⁰⁰ The evidence which HVY referred to in the first instance is in any case no well-founded substantiation for its opinion that there was no evidence for the fraud in Mordovia, see also Statement of Defence, §§ II.640; Reply, §§ 690-697; Rejoinder, § 409.

¹⁹⁰¹ Supreme Court 9 January 2004, *NJ* 2005/190 (*Nannini/SFT Bank*).

¹⁹⁰² Final Awards, marginal 639.

used Mordovian sham companies in order to evade taxes is so incomprehensible that it must be equated to one lacking any reasons (Article 1065(1)(d) DCCP).¹⁹⁰³

E. Reasoning Ground 3 - Several of the Tribunal's findings are based on its own speculations; no sound reasoning

The Russian Federation refers to:		
<u>Arbitrations:</u>		
Final Awards	Chapter VIII.B.5	Marginal nos. 497
	Chapter VIII.B.5a(iii)	§§ 621, 625, 626
	Chapter VIII.B.5b(iv)	§ 694
	Chapter VIII.B.5c(v)	§ 750
	Chapter VIII.F.3a	§ 1023
	Chapter XE.3.c and d	§§ 1625, 1630, 1631
	Chapter XA.3	§§ 1466, 1474, 1480
<u>Setting aside proceedings:</u>		
Writ	Chapter VII.E	§§ 529-531, 555-578
SoD	Part I, Chapter 3.5	§§ 191-195
	Part II, Chapter 4.3	§§ 642-658
SoR	Chapter VI.E	§§ 698-741
SoRej	Chapter 5.5	§§ 411-417
RF Pleading Notes	-	-
HVY Pleading Notes	-	-
SoA	-	-

Primary exhibits:	
<u>Arbitrations:</u>	
(RME-1495) (RF-03.2.C-2.1495)	Resolution of the Supreme Arbitrazh Court, Case no. 17152/09 (6 July 2010)
(RME-1496) (RF-03.2.C-2.1496)	Resolution of the Federal Arbitrazh Court for the Volgo-Vyatsky District, Case no. A29-5718/2008 (14 October 2009)
RME-3328 (RF-03.2.C-2.3328)	OAO Neftyanaya Kompaniya Yukos v. Russia, ECHR, Appl. No 14902/04, Judgment (Sept. 20, 2011) ("First ECtHR Ruling")

Essence of the argument

- The Tribunal based independent grounds for its decisions on its own speculation about what the Russian Federation *might* have done in a fictional scenario, rather than what it *actually* did in reality. Speculations do not amount to sound reasoning. In particular, the Tribunal speculated:
 - about the unlawfulness of reattributing revenues of Yukos' sham companies to Yukos itself;
 - that the Russian Federation would have found a reason to impose fines on Yukos

¹⁹⁰³ See Supreme Court 9 January 2004, NJ 2005/190 (*Nannini/SFT Bank*) and Supreme Court 22 December 2006, NJ 2008/4 (*Kers/Rijpma*).

for incorrect tax assessments no matter what;

- that the Russian Federation would have imposed VAT assessments on Yukos in any case, even if Yukos would have submitted correct VAT returns for the 0% rate in a timely manner;
- that if Yukos had paid the ‘A Loan’ to the banking consortium in a timely manner, the Russian Federation would have found another ground to bankrupt Yukos; and
- that the Russian Federation allegedly instructed Rosneft behind the scenes (*sub rosa*) with regard to the commencement of Yukos’ bankruptcy and Rosneft’s bidding on Yukos assets at the subsequent bankruptcy auctions.

(a) ***Introduction***

1137. In first instance proceedings, the Russian Federation demonstrated that the Tribunal based several *independent* grounds in the Final Awards on *speculations* by the Tribunal itself – i.e., without record evidence to support any such findings – about what the Russian Federation *might* have done, rather than exclusively on the basis of what it *actually* did.¹⁹⁰⁴ The Tribunal did not conceal the speculative character of these views. The Tribunal thus speculated:

- about the unlawfulness of reattributing revenues of Yukos’ sham companies to Yukos itself (see §§ 1144-1154 below);
- that the Russian Federation would have found a reason to impose fines on Yukos for incorrect tax assessments no matter what (see § 1155 below);
- that the Russian Federation would have imposed VAT assessments on Yukos in any case, even if Yukos had submitted correct VAT returns for the 0% rate in a timely manner (see §§ 1156-1157 below);
- that, even if Yukos had paid the ‘A Loan’ to the banking consortium in a timely manner, the Russian Federation would have found another ground to bankrupt Yukos (see §§ 1158-1160 below); and
- that the Russian Federation allegedly instructed Rosneft behind the scenes (*sub rosa*) with regard to the commencement of Yukos’ bankruptcy and Rosneft’s bidding on Yukos assets at the subsequent bankruptcy auctions (see §§ 1161-1162 below).

¹⁹⁰⁴ See Writ, §§ 529-531 and 555-578; SoR, §§ 698-741.

1138. Not a shred of evidence for the Tribunal's speculations in question can be found in the file of the Arbitrations, which is why such evidence is not mentioned in the Final Awards either. As described further below, the findings of such politically inspired motivations for the tax assessments were specifically rejected by the ECtHR and thus it was particularly objectionable that the Tribunal chose to speculate. Therefore, these speculations do not constitute a sound substantiation, because mere speculations cannot constitute grounds for the decisions rendered in the Final Awards as required by Article 1057(4)(e) DCCP¹⁹⁰⁵ (additionally, it is contrary to public policy).
1139. These speculations constitute independent and crucial grounds leading to the Tribunal's ruling that the main objective of the fines and VAT assessments the Russian Federation imposed on Yukos was to bankrupt Yukos and to expropriate its valuable assets, and in turn for its ultimate ruling that the Russian Federation expropriated HVY's investments in violation of Article 13(1) ECT.¹⁹⁰⁶ The decisions in question, and therewith the Final Awards as a whole, can thus be set aside on the basis of Article 1065(1)(d) DCCP, among others.
1140. These speculations of the Tribunal are not further discussed by HVY in the Statement of Appeal at all. In the first instance, HVY justified the speculations of the Tribunal by arguing that these were based on the Tribunal's broader decision that the Russian Federation participated in a large-scale conspiracy to destroy Yukos.¹⁹⁰⁷ In making this submission, HVY are putting the cart before the horse: after all, the said broader decision is based on speculations and not on any evidence.¹⁹⁰⁸
1141. With this assertion, moreover, HVY wrongly ignores the fundamental requirement that a tribunal must provide sound reasoning for each of its critical decisions and, based on this, may not draw any specific conclusions based on a broader decision inspired largely by speculation. The Final Awards do not contain any reference to concrete evidence for the Tribunal's decision that the dismantling of Yukos was the result of a preconceived plan by

¹⁹⁰⁵ SoR, § 701.

¹⁹⁰⁶ Final Awards, marginal nos. 756 and 1579. Incidentally, HVY acknowledge that these speculations, which HVY did not qualify as such, serve as bases for the "*most important conclusion of the Tribunal*"; see SoRej., § 414.

¹⁹⁰⁷ SoD, part I, § 195 and SoRej., § 414.

¹⁹⁰⁸ SoR, §§ 703-706.

the Russian Federation to transfer Yukos' valuable assets to the Russian Federation.¹⁹⁰⁹ Nor do HVY refer in their submissions to any concrete evidence for this major conspiracy theory.

1142. Furthermore, two separate chambers of the ECtHR declared HVY's supposed starting point for the speculation by the Tribunal, i.e., that the Russian Federation was involved in a conspiracy to destroy Yukos, to be unfounded.¹⁹¹⁰ These decisions have furthermore been confirmed by the Grand Chamber of the ECtHR in the rejection of the appeals lodged thereagainst. In *Yukos v. Russia* and *Khodorkovsky and Lebedev v. Russia*, the ECtHR ruled unanimously that the demise of Yukos was caused by its own tax evasion; not by misconduct of the Russian Federation. The ECtHR also unanimously rejected Yukos' assertion that the imposed tax assessments were politically motivated.¹⁹¹¹

1143. As the Russian Federation has demonstrated in the first instance,¹⁹¹² and as it will summarize hereafter for this Court of Appeal's convenience, the arguments that HVY advanced in the first instance¹⁹¹³ as sustenance for the Tribunal's specific speculations were all unfounded as well.

(b) *Speculation in respect of reattributing revenues of Yukos' sham companies to Yukos itself*

1144. In the Arbitrations, the Russian Federation relied *inter alia*, on the *Korus-Holding* case in the context of its assertion that reattribution of the revenue of Yukos' sham companies to Yukos was a legitimate exercise by the Russian Federation of its right to tackle tax evasion. This right existed in the Russian Federation at the time of the VAT assessments as well. However, the Tribunal rejected the reattribution of the revenues of the sham companies to

¹⁹⁰⁹ Moreover, HVY do not dispute these points advanced by the Russian Federation in the first instance. They do not discuss them in the SoA either.

¹⁹¹⁰ First ECtHR Ruling, §§ 591 and 593 (RME-3328). See also § 1118 above.

¹⁹¹¹ First ECtHR Ruling, § 665 (RME-3328); see also SoR, §§ 704-706, where the ECtHR Rulings are discussed at length. See DoA, §§ 593-599 for more details on this.

¹⁹¹² Writ, §§ 529-531, SoR §§ 707-740.

¹⁹¹³ SoD, Part I, §§ 192-194, SoD, Part II, 643-658 and SoRej., § 414. As stated above, HVY do not further discuss these speculations in the SoA at all.

Yukos, because the *Korus-Holding* ruling was handed down after the tax assessments had already been imposed on Yukos.¹⁹¹⁴

1145. However, the Tribunal's reasoning is not in keeping with:¹⁹¹⁵

- the Tribunal's ruling that "Korus-Holding case appears to be on all fours with the Yukos case, in terms of the re-attribution remedy (...)",¹⁹¹⁶
- the Tribunal's acknowledgement that the "(...) 'anti-abuse' doctrine would be eviscerated if the tax authorities were unable to attribute income to the person responsible for the wrongdoing",¹⁹¹⁷
- the Tribunal's acknowledgement that "the record before the Tribunal is clear that, at the time of the issuance on 29 December 2003 of the Field Tax Audit Report, the "bad faith taxpayer" doctrine, although it had not yet been gelled in the way that it did in 2006 in the ruling of the Supreme Arbitrazh Court in Resolution No. 53, had been recognized and applied in some Russian court decisions",¹⁹¹⁸
- the fact that when courts are faced with new legal matters, there must be room to take a legal measure against evasion or abuse of tax rules for the first time in order to create a precedent. In the words of the ECtHR: "*in any system of law (...) there is an inevitable element of judicial interpretation and there will always be a need for elucidation of doubtful points and for adaptation to changing circumstances.*"¹⁹¹⁹
- the fact that the Russian courts applied the same reattribution rule in another case after the reattribution of the revenues of its sham companies to Yukos was maintained, and thereby confirmed that this rule is now part of the established case law of the Russian Federation.¹⁹²⁰

¹⁹¹⁴ Final Awards, marginal 621: "*the Korus-Holding case [...] was decided in 2006, well after the assessments against Yukos in 2003 and 2004.*"

¹⁹¹⁵ Cf. SoR, §§ 708-709.

¹⁹¹⁶ Final Awards, marginal 621: "*Korus-Holding case appears to be on all fours with the Yukos case, in terms of the re-attribution remedy (...)*".

¹⁹¹⁷ Final Awards, marginal 625: "*(...) 'anti-abuse' doctrine would be eviscerated if the tax authorities were unable to attribute income to the person responsible for the wrongdoing*".

¹⁹¹⁸ Final Awards, marginal 497: "*the record before the Tribunal is clear that, at the time of the issuance on 29 December 2003 of the Field Tax Audit Report, the "bad faith taxpayer" doctrine, although it had not yet been gelled in the way that it did in 2006 in the ruling of the Supreme Arbitrazh Court in Resolution No. 53, had been recognized and applied in some Russian court decisions.*".

¹⁹¹⁹ First ECtHR Ruling, § 598 (RME-3328).

¹⁹²⁰ For instance, the Russian courts also applied the reattribution principle in the *Milk Factory – Syktyvkar* case adjudicated in 2007, in which the real party in interest was taxed instead of the sham companies that Milk Factory Syktyvkar had incorporated for the sole purpose of tax evasion. Resolution of the Supreme Arbitrazh Court, Case no. 17152/09 (6 July 2010) (RME-1495) and Resolution of the Federal Arbitrazh Court for the Volgo-Vyatsky District, Case no. A29-5718/2008 (14 October 2009) (RME-1496).

1146. These contradictions mean that the Tribunal's reasoning for not already applying the *Korus-Holding* precedent to the abuse by Yukos itself, and thus rejecting the legal correctness of the reattribution of the revenues of sham companies to the party that abused them, is not sound.^{1921/1922}
1147. In addition to creating these internal contradictions in the Yukos Awards, the Tribunal goes on to elaborate upon this obviously incorrect and incomprehensibly substantiated decision by speculating that the reattribution principle *must have been* part of the Russian Federation's conspiracy to expropriate Yukos' possessions.¹⁹²³ The Tribunal held that it would in fact have been inclined to accept the 'reattribution argument' of the Russian Federation if it applied solely to the profits previously designated as own revenues of its sham companies. However, in the end the Tribunal decided against it due to the VAT assessments also imposed on Yukos, for transactions that fell under the 0% rate at its sham companies.¹⁹²⁴ This is another example of a Tribunal finding that is based purely on its own speculative decision. The criticism is justified on account of, among other things, the following three reasons.
1148. First of all, the Tribunal ruled that the approach adopted by the Tax Ministry was consistent in the sense that revenues generated by the sham companies through their made-up activities were labelled as Yukos revenues for purposes relating to both profit tax and VAT.¹⁹²⁵
1149. Second, the only plausible explanation for why the Tribunal, in spite of its confirmation that it was inclined to accept the Russian Federation's argument as far as profit tax was

¹⁹²¹ This is all the more strange because the Tribunal does acknowledge that reattribution of the revenues to Yukos is in accordance with Russian law, see Final Awards, marginal 668.

¹⁹²² This also disproves HYV's unreasoned assertion in the first instance (SoRej., § 417) that the Tribunal's rejection of the reattribution to Yukos of the revenues of its sham companies was based on the evidence available.

¹⁹²³ Final Awards, marginal no. 626. See also SoR, §§ 710-711.

¹⁹²⁴ *Idem*.

¹⁹²⁵ Final Awards, marginal no. 668: "*the approach taken by the Tax Ministry was consistent in the sense that revenue was recognized as revenue of Yukos for both profit tax and VAT purposes*". See also SoR, § 712.

concerned,¹⁹²⁶ still rejected this argument for the profit tax, because otherwise it would have had to accept the same argument for Yukos' higher VAT assessments.¹⁹²⁷

1150. Third, the consideration that the Tribunal “*could have been persuaded*”¹⁹²⁸ to, but did not, apply the *Korus-Holding* precedent to the assessment for Yukos' profit tax is incomprehensible as these assessments had already been imposed on Yukos before the *Korus-Holding* precedent was handed down. Therefore, the Tribunal's refusal to apply the *Korus-Holding* ruling to the VAT assessment imposed on Yukos because these predated the precedent is a fallacy.¹⁹²⁹

1151. Fourth, the Tribunal's finding is diametrically opposed to the ruling of the ECtHR, which unanimously consented to the Russian Federation's application of the reattribution argument to both Yukos' profit tax assessments and its VAT assessments.¹⁹³⁰ The Tribunal also ignored the ECtHR's findings that (i) Yukos had to file VAT returns in its own name in accordance with the – clear and accessible – requirements to qualify for the 0% rate, (ii) Yukos had failed to submit correct VAT returns for the 0% rate in a timely manner, and (iii) Yukos was not singled out for invidious treatment in respect of these assessments.¹⁹³¹ Established case law dictates that the Dutch court must follow this interpretation by the ECtHR.¹⁹³²

1152. HVY's allegation in the Statement of Rejoinder that the Russian Federation's reattribution argument was advanced out of time,¹⁹³³ as it was not advanced until the Statement of Reply, must be rejected. The objections to the Tribunal's groundless finding that the reattribution of revenues from Yukos' trading shells to Yukos itself was unlawful were already raised by the Russian Federation in the Writ.¹⁹³⁴ Even if that were different, (*quod non*) the Russian Federation's argument is no more than a further factual elaboration of a

¹⁹²⁶ Final Awards, marginal no. 626.

¹⁹²⁷ SoR, § 713.

¹⁹²⁸ Final Awards, marginal no. 626.

¹⁹²⁹ SoR, § 714.

¹⁹³⁰ First ECtHR Ruling, § 598 (RME-3328). SoR, §§ 704 and 715.

¹⁹³¹ First ECtHR Ruling, §§ 601-602 (RME-3328).

¹⁹³² See DoA, § 832 and fn 1456 for more details on this.

¹⁹³³ SoRej., §§ 412-413 and 416.

¹⁹³⁴ Writ, §§ 325-331, 530 and 555-556.

ground for setting aside that was already advanced in the Writ (no sound reasoning)¹⁹³⁵ and therefore cannot be disregarded as having been advanced out of time.¹⁹³⁶

1153. In the Statement of Rejoinder, HVY also alleged for the first time that the Russian Federation's objection to the Tribunal's decision not to apply *Korus-Holding* was based on an incorrect representation of the Tribunal's decision.¹⁹³⁷ HVY's allegation fails because a bare perusal of the Yukos Awards evidences that the Russian Federation most certainly represented the Tribunal's speculative decision accurately.¹⁹³⁸

1154. The reattribution argument was rejected by the Tribunal based on an incorrect and incomprehensible motivation that is contradictory to various other findings of the Tribunal and the evidence in the Arbitrations case file. The Tribunal went on to elaborate thereupon by speculating that the reattribution had to have been part of the Russian Federation's alleged conspiracy to destroy Yukos. This speculation cannot be reconciled with other findings by the Tribunal either, nor did the Arbitrations case file contain any evidence for it whatsoever.

(c) ***Speculation about fines imposed on Yukos***

1155. The Tribunal brushed aside the Russian Federation's argument that Yukos could have avoided (virtually) all fines by submitting correct tax returns in a timely manner, or by paying the tax claim under protest, by speculating that even if Yukos had avoided the fines in such a way, the Russian Federation would still have found a way or a reason to impose the fines on Yukos.¹⁹³⁹ Neither the Arbitrations case file nor the Final Awards contained any evidence for this speculation by the Tribunal.

(d) ***Speculation about VAT assessments imposed on Yukos***

1156. The Tribunal openly speculated that the Russian Federation would have charged Yukos for VAT either way, even if Yukos were to have complied with the VAT declaration

¹⁹³⁵ See also Writ, §§ 530 and 555-556.

¹⁹³⁶ See Supreme Court 27 March 2009, NJ 2010/170 (*Smit Bloembollen/Ruwa Bulbs*) and, for more details, DoA, §§ 271-272.

¹⁹³⁷ SoRej., § 416.

¹⁹³⁸ SoR, § 708. Furthermore, the Russian Federation referred in a footnote to the marginal in the Final Awards where this Tribunal decision was included.

¹⁹³⁹ See Writ, § 530(b) and SoR, § 717, referring to Final Awards, marginal no. 750: "*the Russian Federation would still have found a way or a reason to impose the fines on Yukos.*"

requirements (consequent to which, according to the Tribunal's unsubstantiated view, Yukos would have obtained a 0% VAT rate). This is because, according to the Tribunal, the Russian Federation was determined to charge Yukos for VAT no matter what, even if Yukos would have submitted documented tax returns in a timely manner.¹⁹⁴⁰ Neither the Arbitrations case file nor the Final Awards contained any evidence for this speculation of the Tribunal.¹⁹⁴¹

1157. Moreover, the speculative finding of the Tribunal is incomprehensible in light of the aforementioned ECtHR rulings, in which the accusations of discrimination, political motives and expropriation have been expressly rejected and in which, with reference to the Russian VAT rules, it was explicitly ruled that this taxation was right and correctly motivated.¹⁹⁴²

(e) *Speculations about Yukos' bankruptcy proceeding*

1158. The Tribunal openly speculated about the *inevitability* of Yukos' bankruptcy on numerous occasions.

1159. The Tribunal rightly ruled that Yukos contributed to circumstances that resulted in the filing of the bankruptcy against Yukos.¹⁹⁴³ The Tribunal incomprehensibly ignores its own important decision on the matter by finding that it is difficult to conclude that, even if Yukos had paid the 'A Loan', the Russian Federation would not have found another ground

¹⁹⁴⁰ Final Awards, marginal 694: "*determined to impose the VAT liability on Yukos, and would have done whatever was necessary to ensure that the VAT liability was imposed on Yukos. (...) **no matter what Yukos did.***" [emphasis added]

¹⁹⁴¹ See SoR, §§ 722-730, from which, among other things, it follows that the Tribunal recognised that there was a practical justification for the statutory requirements, which applied to all Russian tax subjects, that had to be satisfied in order to obtain a VAT exemption, and that it is not in dispute that Yukos did not satisfy such requirements.

¹⁹⁴² DoA, § 593-599. See also SoR, § 730. The Tribunal also speculated about the impossibility under Russian law to reattribute to Yukos the VAT returns submitted by its sham companies and the, according to the Tribunal, lack of formality for the reattribution of revenues to Yukos, see SoR, § 718.

¹⁹⁴³ Final Awards, marginal 1630: "*Yukos was in a position to pay off the balance of the A Loan and [...] its willful failure to do so contributed to the circumstances of its bankruptcy by leading SocGen to petition for it.*" See also Final Awards, marginal 1632: "*Yukos may have been at fault in refusing to pay off the A Loan.*" The doubt the Tribunal expressed by using the word "*may*" already demonstrates an incomprehensible and biased finding, as an irrevocable conviction of Yukos in this respect had been around for a while already and the banking consortium had already demanded performance from Yukos numerous times.

for pushing Yukos into bankruptcy.¹⁹⁴⁴ In its Final Awards, the Tribunal does not refer to, nor does the Arbitrations case file contain, any evidence on which the Tribunal allegedly based this mere speculation regarding a conspiracy by the Russian Federation to destroy Yukos.¹⁹⁴⁵

1160. The Tribunal acknowledged, as did the tribunals in *RosInvestCo* and *Quasar*,¹⁹⁴⁶ that the YNG auction could have resulted in a higher price if Yukos itself would not have scared off prospective bidders by publicly threatening them with a “*lifetime of litigation*”, by initiating American bankruptcy proceedings, and by obtaining an injunction consequent to which important potential bidders would not be able to participate in the auction and important potential financiers were prevented from supporting bidders. Nevertheless, the Tribunal attributed no significance to these blockades that Yukos put up itself, on the basis of its entirely unsubstantiated speculation that a higher auction price would have made no difference because Yukos’ bankruptcy was inevitable.¹⁹⁴⁷ Moreover, this is incompatible with the significance that the Tribunal, for its accusation of ‘expropriation’, attributed to the proceeds of the auction of YNG which, according to the Tribunal, were too low.¹⁹⁴⁸

(f) ***Speculation about sub rosa direction from Russian Federation to Rosneft***

1161. The Tribunal expressed another unsubstantiated speculation when it attributed to the Russian Federation the conduct displayed by Rosneft surrounding the start of Yukos’ bankruptcy and Rosneft’s bidding on Yukos assets in the bankruptcy auctions.

1162. The Tribunal formulated the following standard for the attribution of Rosneft’s conduct in question to the Russian Federation: “[t]he conduct of a person or group of persons shall be considered an act of State[...] if the person or group of persons is in fact acting on the instructions of, or under the direction and control of, that State in carrying out the

¹⁹⁴⁴ Final Awards, marginal no. 1631: “(...) it is difficult to conclude that, even if the [A Loan] had been paid, another ground for pushing Yukos into bankruptcy would not have been found.”

¹⁹⁴⁵ Writ, § 530(c); SoR §§ 731 and 734.

¹⁹⁴⁶ The Tribunal relies on these rulings in Final Awards, marginal 1023.

¹⁹⁴⁷ Final Awards, marginal no. 1023: “these actions, at the end of the day, had no relevant impact on the bankruptcy of Yukos,” and marginal 1625: “[Yukos’] demise may have been postponed, or the path to its demise altered in some minor way, but it would not have been avoided.”

¹⁹⁴⁸ SoR, §§ 732-733.

conduct.”¹⁹⁴⁹ The Tribunal explicitly ruled that this standard had not been met, because proof of specific State direction was lacking.¹⁹⁵⁰ It speculated, however, that “*it may well be*” that that Rosneft did so at the “*sub rosa direction*” of the Russian Federation.¹⁹⁵¹ The expression “*it may well be*” already shows that this was merely the Tribunal’s own speculation. But, incomprehensibly, this speculation was the only basis for the Tribunal to attribute to the Russian Federation the conduct displayed by Rosneft surrounding the petition for Yukos’ bankruptcy and at the bankruptcy auctions. The case file did not contain any evidence for this speculative finding of the Tribunal.¹⁹⁵²

(g) ***Conclusion: speculations do not amount to sound reasoning***

1163. All of the speculations discussed above lead – if not individually, then in any event in their mutual conjunction – to the conclusion that the Tribunal has failed to provide sound reasoning for essential findings supporting the outcome of the Arbitrations. For this reason, the Final Awards should be set aside on the basis of a violation of the obligation to provide reasons (Article 1065(1)(c) DCCP).

F. Reasoning Ground 4 - The Tribunal’s finding regarding the YNG shares is internally inconsistent; the reasoning is not sound

The Russian Federation refers to:		
<u>Arbitrations:</u>		
Final Awards	Chapter VIII.F	§§ 1020-1023; 1034-1037
<u>Setting aside proceedings:</u>		
Writ	Chapter VII.F	§§ 532-534
SoD	Part II, Chapter 4.4	§§ 659-663
SoR	Chapter VI.F	§§ 742-777
SoRej	Chapter 5.6	§§ 418-422
RF Pleading Notes		
HVY Pleading Notes		
SoA		

¹⁹⁴⁹ Final Awards, marginal no. 1466: “[t]he conduct of a person or group of persons shall be considered an act of State[...] if the person or group of persons is in fact acting on the instructions of, or under the direction and control of, that State in carrying out the conduct.”

¹⁹⁵⁰ Final Awards, marginal no. 1480: “proof of specific State direction is lacking.”. Moreover, the Tribunal’s findings demonstrate that the mere fact that the Russian Federation had a controlling interest in Rosneft is insufficient a basis on which to attribute Rosneft’s conduct to the Russian Federation, and also that there is no question of an exercise of government powers upon which such an attribution can be based, see SoR, §§ 737-738. Contrary to what HVY allege, Putin’s statement about the YNG auction cannot lead to this attribution either, see SoR § 739.

¹⁹⁵¹ Final Awards, marginal no. 1474: “it may well be that in taking these actions, Rosneft did so at the sub rosa direction of the Russian State.” See also Writ, § 530(d).

¹⁹⁵² Writ, § 530(d), and SoR, §§ 735-736.

Primary exhibits:

Arbitrations:

Setting aside proceedings:

Essence of the argument

- The conclusions of the Tribunal with regard to the YNG auction are internally inconsistent and constitute a violation of the duty to state reasons:
- The opinion that the YNG shares have been sold for a price “far below” their fair value is contradictory to the own valuation of the Tribunal of Yukos as a whole.
- The realised value of the YNG shares (USD 9.35 billion) was instead USD 300 million *higher* than the fair value (USD 9.04 billion, according to the Tribunal).
- The ruling on the YNG auction served as an independent ground for allowing the expropriation claim.

(a) ***Introduction***

1164. In the first instance, the Russian Federation has demonstrated that the conclusions of the Tribunal in the Yukos Awards regarding the YNG auction are internally inconsistent and that its finding that the YNG auction was manipulated as a result of this, lacks the required sound reasoning.¹⁹⁵³ Indeed, an internally inconsistent decision results in a violation of the duty to state reasons.¹⁹⁵⁴

1165. The Russian Federation maintains the reasoning it gave in the first instance for this ground for setting aside, namely the failure to provide tenable reasons for the Tribunal's conclusions to provide this Court of Appeal with an overview, the Russian Federation once again sets out the essence of its previous argument in this respect. In the Statement of Appeal, HVY no longer discuss this ground for setting aside.

¹⁹⁵³ See Writ, §§ 532-534, and SoR, §§ 742-777.

¹⁹⁵⁴ Cf. Amsterdam District Court, 7 December 2011, ECLI:NL:RBAMS:2011:BV3821.

- (b) ***The unsubstantiated finding of the Tribunal that the YNG shares were sold for a price far below their fair value contradicts its own valuation of Yukos as a whole***

1166. The Tribunal's findings concerning the YNG auction are internally inconsistent. Its finding that the YNG shares had been sold at a price "far below the fair value of those shares"¹⁹⁵⁵ and that there had therefore been manipulation and expropriation¹⁹⁵⁶ is arithmetically incompatible with the Tribunal's own valuation of the total market value of Yukos as a whole, including YNG.¹⁹⁵⁷

1167. The valuation of the Tribunal for Yukos's total market value¹⁹⁵⁸ shows that the price realised for the YNG shares auctioned, USD 9.35 billion, was more than USD 300 million higher than their fair value; USD 9.04 billion, according to the Tribunal.

- The Tribunal ruled that the total equity value of Yukos amounted to USD 21.176 billion in December 2004;¹⁹⁵⁹
- according to HVY's expert, Mr Kaczmarek, who was followed in this respect by the Tribunal, YNG at the time represented 55.6% of the total equity value of Yukos¹⁹⁶⁰: an amount of USD 11.77 billion¹⁹⁶¹;
- The fair market value of the 76.79% of the YNG shares that were sold at the auction is therefore USD 9.04 billion.¹⁹⁶²

¹⁹⁵⁵ HVY defended themselves in the first instance (see SoRej., § 422) by claiming that the assessment of YNG's "fair value" at the time of the auction by the Tribunal was "based on different facts" (including two valuations of YNG by commercial banks of between USD 15.7 and USD 22 billion (Final Award, marginal 1013)). However, these figures are not relevant for YNG, because in the ultimate valuation findings of the Tribunal these facts were taken into account. The divergent figures quoted by HVY are indeed higher than the value calculated by the Tribunal for the *whole* of Yukos in December 2004. Nevertheless that does not affect the current ground for setting aside which challenges the finding of the Tribunal in this respect.

¹⁹⁵⁶ Final Awards, marginal nos. 1020-1023, 1034-1037.

¹⁹⁵⁷ Writ, § 571.

¹⁹⁵⁸ Final Awards, marginal no. 1815.

¹⁹⁵⁹ Final Awards, marginal no. 1815.

¹⁹⁶⁰ HVY's expert, Mr Kaczmarek, calculated that the enterprise value of Yukos as a whole would have been USD 49.6 billion and the enterprise value of YNG would have been USD 27.6 billion, see Second Kaczmarek Report, § 99. In its SoR, § 758, the Russian Federation therefore concluded that YNG's valuation represented 55.6% of Yukos' valuation. See also Writ, § 571, SoR, § 747.

¹⁹⁶¹ 55.6% of USD 21.176 billion. See also SoR, § 758.

¹⁹⁶² 0.7679 x USD 11.774 billion. See Writ, §§ 570-571, SoR, § 747.

1168. HVY's reproach in the first instance¹⁹⁶³, that the Russian Federation now makes its own "calculations" is incorrect. These are figures of the Tribunal itself which, in turn, relied on the same figures as those as HVY's expert used.¹⁹⁶⁴ The fair market value of the YNG shares follows directly from the value the Tribunal attributed to Yukos and the figures of Mr Kaczmarek for the part of Yukos that can be attributed to YNG.¹⁹⁶⁵

(c) ***The opinion on the YNG auction supported the award of the expropriation claim in the Final Awards***

1169. The opinion on the YNG auction supported the Final Awards. On the basis of the *assumption*¹⁹⁶⁶ that the YNG shares were sold for a price far below their fair market value, the Tribunal concluded that the 2004 auction was rigged.¹⁹⁶⁷ The Tribunal continued that the sale of the shares in YNG on the manipulated auction was the fatal blow that Yukos could not survive: "(...) *the sale of YNG dealt a "fatal blow" to the survival prospects of Yukos. Was the sale of YNG the point of no return for the survival of Yukos? (...) the Tribunal answers that question in the affirmative.*"¹⁹⁶⁸ The Tribunal subsequently awarded HVY's expropriation claim: "(...) *it was in effect a devious and calculated expropriation by Respondent of YNG*".¹⁹⁶⁹

1170. If the Tribunal had consistently followed its own judgment with regard to the market value of Yukos, it should have concluded that the YNG shares were sold for a price above - instead of '*far below*' - their fair value. Yukos therefore received a windfall at the YNG auction instead of a fatal blow. The general conclusion of the Tribunal that the YNG auction had been manipulated and that it was the fatal blow that Yukos could not overcome, is therefore untenable. HVY's expropriation claim should have been denied because Yukos was not deprived of anything of value by the YNG auction.¹⁹⁷⁰ In light of

¹⁹⁶³ See Statement of SoRej., §§ 419 et seq.

¹⁹⁶⁴ SoR, §§ 760-762.

¹⁹⁶⁵ The fact that the Tribunal has not performed a quantitative analysis of this specific matter demonstrates once again that it did not have a reasonable basis to conclude that the YNG shares were sold during a "rigged" auction for an inadequate price.

¹⁹⁶⁶ See DoA, chapter VI.F(c).

¹⁹⁶⁷ Final Awards, marginal nos. 1020-1023, 1034-1037.

¹⁹⁶⁸ Final Awards, marginal no. 1038.

¹⁹⁶⁹ See Final Awards, marginal nos. 1037, 1625.

¹⁹⁷⁰ SoR § 768.

the above, the finding that the YNG shares were sold “*far below*” their actual value is in any case not sound. In addition, even under normal circumstances, and therefore *a fortiori* with the circumstances under which the YNG auction took place (with a restriction on potential bidders and their financiers provoked by Yukos itself¹⁹⁷¹), an optimal price is rarely, if ever, achieved with sales under execution.

(d) ***Conclusion: unsound reasoning because of internally inconsistent conclusion with regard to the YNG auction***

1171. One of the most fundamental conclusions drawn by the Tribunal is thus not reasoned, or at least can be put on a par with the case that although a reasoning was provided, it does not contain any sound explanation for the decision in question (Article 1065(1)(d) DCCP). The only other grounds that the Tribunal states for this judgment about the YNG shares are after all also based on incorrect presumptions and speculation (see DoA chapters VI.F and VII.F).¹⁹⁷² For that reason, too, the Yukos Awards must be set aside.

¹⁹⁷¹ See § 1193 below.

¹⁹⁷² Writ, §§ 569-573 and SoR, §§ 823-824. HVY's defence that the judgment of the Tribunal regarding the manipulation of the YNG auction was based on a 'totality of circumstances leading to the YNG auction and the auction itself' (see SoRej., § 420), also fails for this reason therefore. The Tribunal assumed that the YNG auction price was far below the fair market value and then concluded that this alleged price was too low due to the circumstances of the auction. Without assuming the result was rigged there would have been no reason for the Tribunal to look for a story that matches the assertion of manipulation of an auction in the circumstances of an auction. For an elaborate refutation in this respect see SoR, §§ 770-773.

VII. GROUND FOR SETTING ASIDE 5 - THE YUKOS AWARDS ARE CONTRARY TO THE PUBLIC POLICY (ARTICLE 1065(1)(E) DCCP)

A. Introduction

1172. In the first instance, the Russian Federation has advanced that the Yukos Awards should be set aside, inter alia, because of contrariety with the public policy. The contrariety with the public policy consists of:

- (a) Violation of the principle of hearing both sides;
- (b) Violation of equality of arms;
- (c) Violation of the impartiality and independence;
- (d) Violation due to fraud.

1173. The violation of these principles relates to the following points of the Yukos Awards:

- (a) No referral to the competent tax authorities and the surprise decision with the Arbitral Tribunal's own damage calculation method (Public Policy Ground 1);
- (b) Decision by conjecture by the Arbitral Tribunal (Public Policy Ground 2);
- (c) The Arbitral Tribunal relied on its own opinion about what the Russian law should have stipulated instead of on what the Russian law did actually stipulate (Public Policy Ground 3);
- (d) The ruling of the Arbitral Tribunal on the YNG shares is inherently inconsistent with its own valuation of Yukos and based on pure speculation (Public Policy Ground 4);
- (e) HVY's Fraud in the Arbitration Requires Set-Aside of the Yukos Awards on Public Policy Grounds (Public Policy Ground 5);
- (f) Enforcement of the Yukos Awards would violate Public Policy regarding Fraud, Corruption, and other Serious Illegality (Public Policy Ground 6).

1174. The Russian Federation fully maintains its substantiation of this ground for setting aside given in the first instance (violation of public policy, Article 1065(1)(e) DCCP).¹⁹⁷³ For the

¹⁹⁷³ See Writ, Section V.C., and SoR, Section IV.C.

Court of Appeal's convenience, the Russian Federation will present the essence of its earlier argument once again in this chapter, without prejudice to the devolutive effect of the appeal. It should be noted that that HVY did not put forward public policy in its Statement of Appeal.

1175. As noted previously, this Court of Appeal need not confine itself to a discussion of the grounds for appeal of the appellant. The Court of Appeal may also immediately, or in addition thereto, or instead thereof, proceed to a discussion and decision on the, based on the devolutive effect of the appeal, still remaining basis of the claim of the respondent.¹⁹⁷⁴ As such, it is possible to dispose of the case based on an aspect of the violation of public policy.

B. Legal framework

1176. Both the substance of an arbitral award and the manner in which it has been arrived at can be contrary to the public policy.¹⁹⁷⁵

1177. All violations advanced by the Russian Federation under setting-aside ground 'contrariety with the public policy' (Article 1065(1)(e) DCCP) shall be reviewed not cautiously but, indeed, in full.

1178. In its Reply, the Russian Federation explained in detail that apart from a violation of the fundamental right to be heard, also a violation of the fundamental right to equal treatment (Article 6 ECHR and Article 1039 DCCP) and a violation of the fundamental requirement of impartiality and independence (Article 6 ECHR and Article 1033 DCCP) are provisions of public policy and of *supermandatory law*, and are subject to a full review.¹⁹⁷⁶ The same applies if the content of the arbitral award violates the public policy. All this has not been contradicted by HVY.

¹⁹⁷⁴ See fn 1470 above.

¹⁹⁷⁵ See for a further elaboration Writ, Chapter VIII (Ground 5), Part B (Legal framework) and SoR, Chapter VII (Ground 5), Part B (Legal framework).

¹⁹⁷⁶ See SoR, Chapter VII (Ground 5), Part B (Legal framework).

1179. Moreover, the starting point that all setting-aside grounds shall be advanced in the originating writ of summons subject to forfeiture of rights, is varied from for setting-aside grounds of a public-policy nature.¹⁹⁷⁷

1180. Once a violation of public policy – in the sense of the three above-mentioned principles (being the right to be heard, the right to equal treatment and the right to impartiality and independence in arbitral decision-making) – has been established, setting aside is required. The setting-aside court should not be cautious. The three principles at issue are so fundamental that interest in upholding the arbitral administration of justice must yield. In fact, failing to set aside an arbitral award despite such violations would undermine public confidence in arbitration.

1181. As – inter alia – Snijders states in his note on *IMS/Modsaf*:

“If an arbitral award is actually in violation of public policy or good morals, is not all hope lost? I cannot quite imagine that the civil court deems an arbitral award to be in breach of public policy or good morals but is subsequently of the opinion that it has to uphold this award in light of the required caution.”¹⁹⁷⁸

1182. There are numerous precedents in case law of judgments setting aside arbitral awards due to a violation of public policy (Article 1065(1)(e) DCCP).¹⁹⁷⁹ The present case also provides an example of an award which violates public policy in several respects, as demonstrated in the first instance. Precisely because the starting point of an effectively functioning administration of justice must be preserved, the Yukos Awards must be set aside because they are contrary to public policy.¹⁹⁸⁰

¹⁹⁷⁷ See also P. Sanders, *Het Nederlandse arbitragerecht: nationaal en internationaal*, Deventer: Kluwer 2001, p. 190-191, G.J. Meijer, *T&C DCCP*, article 1064a DCCP, note 5(b), H.J. Snijders, *GS Burgerlijke Rechtsvordering*, Article 1064 DCCP, note 3.

¹⁹⁷⁸ SC 17 January 2003, *NJ* 2004, 384.

¹⁹⁷⁹ In addition to the 18 examples referred to in SoR, fn. 1080, see: Overijssel District Court, 14 October 2015, ECLI:NL:RBOVE:2015:4600 (*Eisers / Natuurmonumenten*). Also in other jurisdictions, arbitral awards have been set aside, for example in case of a surprise decision of the tribunal. See for example the decisions of the French *Court d'Appel de Paris* dated 15 March 2016 (**Exhibit RF-406**) and the *Cour de Cassation* dated 20 June 2017 (**Exhibit RF-407**) in *République de Madagascar c. De Sutter*. See also the decision of the French *Court d'Appel de Paris* dated 22 September 2015 in *République de Guinée Equatoriale c/ Orange Middle East and Africa* (**Exhibit RF-408**): "alors que le taux retenu ne résultait pas d'une stipulation contractuelle et ne figurait pas dans les écritures de FCR, de sorte que son adversaire n'avait pas été mise en mesure de le discuter, les arbitres ont violé le principe de la contradiction".

¹⁹⁸⁰ See for example SC 17 January 2003, ECLI:NL:HR:2003:AE9395, *NJ* 2004, 384 (*IMS/Modsaf-IR*), legal ground 3.3; SC 9 January 2004, ECLI:NL:HR:2004:AK8380, *NJ* 2005, 190 (*Nannini/SFT Bank*), legal

C. **Public Policy Ground 1 - The Tribunal's violation of the right of both sides to be heard and the right to equality of arms**

The Russian Federation refers to:		
<u>Arbitrations:</u>		
Final Awards	Chapter XII	marginal nos. 1693-1829
<u>Setting aside proceedings:</u>		
Writ	Chapter V.C and D, VII.C	§§ 368-463, 524-525
SoD	Part I, Chapter 3.6	§§ I.200-213
	Part II, Chapter 3.1 and 3.2	§§ II.459-596
SoR	Chapter VII.C.a	§§ 808-811
SoRej	Chapter 6.2	§§ 428, 430-431
Pleading Notes RF	-	-
Pleading Notes HVY	Chapter 6	§§ 162-170
SoA	-	-

Primary exhibits:		
<u>Arbitrations:</u>		
-	-	-
<u>Setting aside proceedings:</u>		
-	-	-

Essence of the argument

The Tribunal breached the principles of the right to adversarial proceedings and the right to equality of arms in at least two respects:

- The Tribunal rendered a surprise decision on the damage calculation. The parties were heard neither on the subject of the new reference dates for the damage calculation, nor on the Tribunal's own calculation method.
- The Tribunal failed to consider the mandatory obligation, presented in Article 21(5) ECT, of referral to the competent tax authorities. By doing so, it deprived the Russian Federation of its right to be heard on the opinions of those competent tax authorities.

ground 3.5.2; SC 25 May 2007, ECLI:NL:HR:2007:BA2495, *NJ* 2007, 294 (*Spaanderman/Anova Food*), legal ground 3.4; SC 24 April 2009, ECLI:NL:HR:2009:BH3137, *NJ* 2010, 171 (*IMS/Modsaf*), legal ground 4.3.1; see also ECtHR 27 November 1996, ECLI:NL:XX:1996:AD2654, *NJ* 1997, 505 (*Nordström/Nigoco*).

1183. The Tribunal violated the right of both parties to be heard and to equality of arms in at least two different respects.
1184. First, the Tribunal violated the right to be heard and to *equality of arms* – as well as the Tribunal's mandate and its obligation to provide tenable reasons for its conclusions – in rendering a "*surprise decision*" with regard to the methodology it developed on its own for calculating HVY's damages.¹⁹⁸¹ The Tribunal used reference dates that had not been discussed, i.e., the date on which YNG was auctioned and the hypothetical date of 30 June 2014 as the date of the Final Awards. It also applied an entirely new method of its own for the damage calculation, for example drawing on the RTS Oil & Gas Index for the equity value and failing to recognise that equity value and dividends are inevitably connected, without hearing the parties either before or after, or without offering an opportunity for them to put forward their views in that respect. The Tribunal had in fact previously rejected the use of RTS Oil & Gas Index for this purpose. This is a textbook example of a surprise decision.¹⁹⁸² Besides the Tribunal's failure to fulfil its mandate, these facts also render the Yukos Awards incompatible with public policy. HVY's argument that the Russian Federation failed to substantiate this argument in the first instance¹⁹⁸³ is incorrect; for example, see Writ, §§ 432, 455, 463, 465, 525, 578; Reply, § 825 and RF's Pleading Notes § 85. A surprise decision in and of itself means that the principle of adversarial proceedings was breached.
1185. Second, the Tribunal violated the right of the parties to be heard and to equality of arms in disregarding the mandatory provisions of Article 21(5) ECT (regarding the mandatory reference to the Competent Tax Authorities), which likewise violated the Tribunal's mandate. Specifically, the Tribunal's failure to comply with Article 21(5) ECT deprived the Russian Federation of its right to be heard by denying the Russian Federation the right to have the Tribunal informed of the conclusions arrived at by the Competent Tax Authorities on these issues.^{1984/1985}

¹⁹⁸¹ Writ, § 386-463, 524-525.

¹⁹⁸² Outside the Netherlands, decisions such as these have caused arbitral awards to be set aside; see footnote 1979 above.

¹⁹⁸³ SoA, § 773.

¹⁹⁸⁴ See also Supreme Court 18 June 1993, *NJ* 1994, 449, ECLI:NL:HR:1993:ZC1003 (*Van der Lely et al/VDH*). See also The Hague Court of Appeal, 31 March 2015, ECLI:NL:GHDHA:2015:713 (*X/Slotervaartziekenhuis*), after reference by the Supreme Court based on its setting aside of the judgment

1186. HVY argued in the first instance that the Parties were not denied a fair hearing, and that there was no unequal treatment of the parties or bias or partiality on the part of the Tribunal, based upon the extent of the proceedings and the substantial size of the case file.¹⁹⁸⁶ HVY's *generic* reference to the extent of the proceedings and the size of the case file obviously does not refute the Russian Federation's *particularized* showing of the *specific* ways in which the Tribunal violated the Russian Federation's right to be heard and to equality of arms. It should also be noted that HVY in its Statement of Appeal do not make any submissions in respect of this ground for annulment invoked by the Russian Federation in the first instance.

D. Public Policy Ground 2 - The Tribunal has violated public policy by basing its award on speculation

The Russian Federation refers to:		
<u>Arbitrations:</u>		
Final Awards	Chapter VII.B.4.b	Marginal 694
	Chapter VII.B.5.c.	Marginal 750
	Chapter IX.A.3	marginal nos. 1474, 1480
	Chapter IX.D	marginal no. 1579
	Chapter IX.E.3.d	marginal nos. 1630-1632
<u>Setting aside proceedings:</u>		
Writ	Chapter VII.E and VIII.C.a, c and d	§§ 529 – 531, 555 – 565 and 569-578
SoD	Part I, Chapter 3.6	§§ 200-206 and 209-213
	Part II, Chapter 4.3	§§ II.642 – 658
	Part II, Chapter 5.1	§§ II.670 – 684
SoR	Chapter VI.E.c(iii) and VII.C.b and d	§§ 812 – 817 and 823-825
SoRej	Chapters 5.5, 5.6 and 6.2	§§ 411-422, 427-428 and 432
RF Pleading Notes		
HVY Pleading Notes	Chapter 6	§§ 162-170
SoA		

of the Amsterdam Court of Appeal (*see* Supreme Court 12 July 2013, ECLI:NL:HR:2013:CA0259 (*X/Slotervaartziekenhuis*)).

¹⁹⁸⁵ HVY's defence that the Russian Federation was too late in arguing that the principle of adversarial proceedings was breached in connection with the referral obligation set forth in Article 21(5) ECT, by reason that the Russian Federation had not made that argument in the Writ, is unconvincing. The assumption that every setting-aside ground must be presented in the writ, on penalty of forfeiture of rights, does not apply to setting-aside grounds that concern public policy. See also Sanders, *Het Nederlandse arbitragerecht: nationaal en internationaal*, Deventer: Kluwer 2001, pp. 190-191, Meijer, *T&C Rv*, Article 1064a DCCP, note 5(b), Snijders, *GS Burgerlijke Rechtsvordering*, Article 1064 DCCP, note 3. Since it has been established that the Tribunal did not refer the matter to the competent tax authorities, it is similarly established that the principle of adversarial proceedings was breached and accordingly the Russian Federation has satisfied its burden of proof in this respect (*see* SoRej., § 260, where HVY argue that the Russian Federation had not satisfied its burden of proof regarding the breach of the principle of adversarial proceedings).

¹⁹⁸⁶ SoD, § I.202.

Primary exhibits:

Arbitrations:Setting aside proceedings:**Essence of the argument**

- The Tribunal has based independent considerations for its decisions on its own speculation about what the Russian Federation *might* have done in a fictional scenario, rather than what it *actually* did in reality. The Tribunal has speculated that:
- the Russian Federation would under all circumstances have imposed VAT assessments on Yukos, even if Yukos had filed correct VAT tax returns sufficient for a 0% rate in a timely manner.
- if Yukos had repaid the ‘A Loan’ to the consortium of banks in a timely manner, the Russian Federation would have found another ground to bankrupt Yukos;
- the Russian Federation allegedly gave behind the scenes (*sub rosa*) instructions to Rosneft with regard to the start of Yukos' bankruptcy and Rosneft's bids on Yukos' assets in the subsequent bankruptcy auctions.

1187. The Russian Federation has shown in first instance (and above in chapter VI under the violation of the obligation to state reasons) that the Tribunal has based several independent grounds for its decisions in the Final Awards on its own speculation on what the Russian Federation *might* have done, rather than exclusively on what it *actually* did.¹⁹⁸⁷ By speculating in this way, the Tribunal not only failed to properly substantiate its decisions¹⁹⁸⁸, but also violated the right of the Russian Federation to be heard, its right to equal treatment and its right to an impartial and independent tribunal. With these violations of fundamental procedural principles, the Tribunal has also acted contrary to public policy.

1188. This applies in particular to the following:

- As shown above,¹⁹⁸⁹ the Tribunal openly speculated that even if Yukos had complied with the VAT declaration requirements (which apparently, according to the Tribunal,

¹⁹⁸⁷ Writ, §§ 529-531, 555-565 and 569-578, SoRej, §§ 812-817 and 823-825.

¹⁹⁸⁸ DoA, chapter VI.E.

¹⁹⁸⁹ DoA, §§ 1156-1157 above. *See also* Writ, §§ 556-557 and SoR, §§ 718-730 and 813.

would have resulted in a 0% VAT rate for all the export transactions in question),¹⁹⁹⁰ the Russian Federation would still have charged Yukos VAT and imposed fines on it. According to the Tribunal, the Russian Federation insisted upon imposing a VAT assessment and fines on Yukos.¹⁹⁹¹ Therefore, the Tribunal speculated that even if Yukos had filed correct tax returns – not only in a timely manner but also accompanied with all the legally required documentation (from orders and invoices to payments and transports) – the Russian would have found another way to charge Yukos for VAT and fines. However, the Tribunal fails to cite any evidence for this speculation. Entirely in conformity with the law, the specific tax assessments were based on the lack of documentation that is compulsory for an exemption or 0% rate, in addition to ignoring the obligation to submit such a request and the required documentation monthly (or quarterly) and in any event not for full years in retrospect.

- As shown above,¹⁹⁹² the Tribunal also speculated about the *inevitability* of Yukos' bankruptcy. After the Tribunal had ruled that Yukos had brought about its own bankruptcy by deliberately failing to repay the A Loan outstanding at the SocGen syndicate (although Yukos was able to do so), the Tribunal speculated that “*even if*” Yukos had repaid that A Loan in a timely and correct manner, the Russian Federation would have found another ground to bankrupt Yukos.¹⁹⁹³ It is beyond question that the Tribunal is speculating here (“*even if*”), and it moreover does so without invoking any evidence or a concrete alternative;¹⁹⁹⁴
- As shown above,¹⁹⁹⁵ the Tribunal also speculated by reattributing actions of Rosneft to the Russian Federation with regard to the petition for the bankruptcy of Yukos (which it had taken over from the consortium of banks) and the bid by Rosneft for Yukos assets at the subsequent bankruptcy auctions. The Tribunal explicitly holds that “*proof of specific State direction is lacking*”¹⁹⁹⁶, through which the standard for attribution was not met, but nevertheless speculated that it is possible for Rosneft to have received instructions from the Russian Federation behind the scenes (*sub*

¹⁹⁹⁰ Moreover, the Tribunal wrongly and unquestioningly assumed that if that were the case Yukos, like its sham companies, would qualify for the 0% VAT rate for the entirety of the exports it declared. However, it is probable and certainly not out of the questions that many of the transactions Yukos concluded for its sham companies with foreign customers – which were also sham companies controlled by Yukos and/or the Oligarchs – only appeared to lead to exports, only on paper.

¹⁹⁹¹ Final Awards, marginal no. 694: “*determined to impose the VAT liability on Yukos, and would have done whatever was necessary to ensure that the VAT liability was imposed on Yukos. (...) no matter what Yukos did.*” And marginal 750: “*the Russian Federation would still have found a way or a reason to impose the fines on Yukos.*”

¹⁹⁹² DoA, §§ 1158-1160 above. *See also* Writ, § 558 and SoR, §§ 731-734 and 813.

¹⁹⁹³ Final Awards, marginal no. 1631: “*it is difficult to conclude that, even if the [A Loan] had been paid, another ground for pushing Yukos into bankruptcy would not have been found.*”

¹⁹⁹⁴ Final Awards, marginal nos. 1630-1631.

¹⁹⁹⁵ DoA, § 1161-1162 above.

¹⁹⁹⁶ Final Awards, marginal no. 1480.

rosa).¹⁹⁹⁷ It is contrary to public policy to base a judgment against the defendant on a mere hypothesis instead of factual evidence, which was acknowledged to be absent.

1189. These findings of the Tribunal constitute independent grounds for its final opinion that the Russian Federation expropriated the investments in Yukos contrary to Article 13(1) ECT.¹⁹⁹⁸ The Tribunal is therefore guilty of unwarranted speculation with regard to considerations that underlie essential opinions in the Final Awards, thereby violating the fundamental safeguards for a fair trial protected by public policy. It should also be noted that HVY in its Statement of Appeal do not make any submissions in respect of this ground for annulment invoked by the Russian Federation in the first instance.¹⁹⁹⁹

E. Public Policy Ground 3 - The Tribunal relied on its own views with regard to what Russian law should have provided rather than on what Russian law actually provided

The Russian Federation refers to:

Arbitrations:

Final Awards	Chapter VII.B.5.b	marginal nos. 685-686
	Chapter IX.D	marginal nos. 1582

Setting aside proceedings:

Writ	Chapter VIII.C.b	§§ 566-568
SoD	Part I, Chapter 3.6	§§ I.206-208
	Part II, Chapter 5.2	§§ II.685-687
SoR	Chapter VII.C.c	§§ 818-822
SoRej	Chapter 6.2	§§ 427-433
RF Pleading Notes		
HVY Pleading Notes	Chapter 6	§§ 162-170
SoA		

Primary exhibits:

Arbitrations:

Setting aside proceedings:

Essence of the argument

¹⁹⁹⁷ Final Awards, marginal no. 1474: "*it may well be that in taking these actions, Rosneft did so at the sub rosa direction of the Russian State.*".

¹⁹⁹⁸ Final Awards, marginal no. 1579.

¹⁹⁹⁹ HVY attempted in first instance proceedings (SoD, Part I, §§ 206, 684 and SoRej., § 432) to justify the inadmissible speculation of the Tribunal on the ground that the findings of the Tribunal are based on the "*totality*" of evidence. The Russian Federation has explained in the SoR, §§ 720-741 and 814-817 and chapter VI.D of this DoA that speculation by the Tribunal is not based on any evidence, but is an example of its bias and prejudice. Furthermore, HVY referred in the first instance to their defence concerning the violation by the Tribunal of the obligation to provide reasons, as alleged by the Russian Federation (SoD, Part I, § 206, SoD, Part II, § 670 and SoRej., § 432). The argument by HVY fails for the reasons put forward by the Russian Federation on that subject in the SoR, §§ 698-741 and this DoA, chapter VI.D.

The Tribunal based its opinion that the VAT assessments imposed on Yukos were unjustified on its own view of what Russian law should have provided, rather than on what Russian law actually provided on the basis of the documentation submitted to the Tribunal.

1190. The Tribunal violated the right of the Russian Federation to be heard, its right to equal treatment and its right to an impartial and independent tribunal by basing important decisions on its own views on what Russian law *should have provided*, rather than on what the Russian law *actually provided* on the basis of the documentation submitted to the Tribunal.
1191. As the Russian Federation already demonstrated in the first instance,²⁰⁰⁰ the Tribunal has recognised that on the basis of generally applicable rules of Russian tax law, Russian taxpayers must file VAT returns *in their own name and in a documented manner* (i.e. with all underlying documents required by law) in order for the alleged exports to qualify for VAT exemption. Nevertheless, the Tribunal found it “*difficult to understand*”²⁰⁰¹ why Yukos should also comply with these VAT declaration rules²⁰⁰², although they applied to all Russian taxpayers. Although the Tribunal has confirmed that there was a “*practical justification*”²⁰⁰³ for the statutory VAT requirements, while it was also established that Yukos had not met those requirements, the Tribunal nevertheless based its award against the Russian Federation on an exception assumed for Yukos, for which, however, there was no basis whatsoever under Russian tax law. Therefore, the Tribunal exclusively based its conclusion that the VAT assessments imposed on Yukos were unjustified on its own subjective opinion of what the Russian law *should have provided*, rather than on what the Russian law *actually provided*, thereby acting contrary to public policy. Indeed, when rendering a decision on the question whether certain taxes were rightly imposed, Tribunals must apply the specific tax laws applicable at that time and not an arrangement or tax ruling they conceived, only because they considered it to be more fair. This is all the more serious in the context of Article 21(1) and 21(5) ECT. It should also be noted that HVY, in

²⁰⁰⁰ Writ, §§ 566-568, SoRej, §§ 818-822.

²⁰⁰¹ Final Awards, marginal 686.

²⁰⁰² Final Awards, marginal 686.

²⁰⁰³ Final Awards, marginal no. 686.

their Statement of Appeal, fail to address this ground for setting aside already invoked and substantiated by the Russian Federation in first instance proceedings.²⁰⁰⁴

F. Public Policy Ground 4 - The Tribunal’s finding regarding the YNG shares is internally inconsistent and is based on the Tribunal’s own speculation

The Russian Federation refers to:		
<u>Arbitrations:</u>		
Final Awards	Chapter VIII.F	marginal nos. 1020-1023, 1034-1037
<u>Setting aside proceedings:</u>		
Writ	Chapter VIII.C.c	§§ 569-573
SoD	Part II, Chapter 5	§§ 659-663
SoR	Chapter VII.C.d	§§ 823-824
SoRej	Chapter 6.2	§§ 427-433
RF Pleading Notes	-	-
HVY Pleading Notes	Chapter 6	§§ 162-170
SoA	-	-

Primary exhibits:		
<u>Arbitrations:</u>		
-	-	-
<u>Setting aside proceedings:</u>		
-	-	-

Essence of the argument

- The judgment of the Tribunal that the YNG shares were sold for a price “far below” fair market value and that the YNG auction was therefore rigged is based solely on own speculation which is not lawful and contrary to public policy:
- the "suspicion" that the winning bidder had been incorporated by the Russian Federation to facilitate the successive purchase of YNG by Rosneft.
- the inference that “but for these actions of Yukos”, Yukos’ ultimate fate “would have been no different”, but "may at most have postponed its demise”, but

²⁰⁰⁴ HVY argue in the first instance (SoD, Part I, §§ 207-208, SoD, Part II §§ 685-687 and SoRej., § 432) in defence of the Tribunal's preference for its own opinions on what Russian law should have provided that it was based on the "totality" of evidence. The Russian Federation has explained in the SoR, §§ 720-741 and 821-822 that the "totality of the evidence" argument does not provide a valid explanation for the Tribunal's reliance on its own views on what Russian law should have provided rather than what the Russian law actually provided. Furthermore, HVY referred in first instance proceedings to their earlier defence concerning the violation of the obligation to provide reasons, since the Tribunal based itself on its own views of what Russian law should have provided (SoD, Part I § 206 and SoRej., § 432). This argument by HVY fails for the reasons put forward by the Russian Federation on that subject in the SoR, §§ 818-822.

altogether “it would not have been avoided.”

1192. The Russian Federation has demonstrated (a) that the YNG shares were not sold (as judged by the Tribunal) for a price "*far below the fair market value of those shares*"²⁰⁰⁵ and (b) that the judgment of the Tribunal on the undervalued auction price is internally contradictory to its own valuation of Yukos and is therefore not soundly substantiated.²⁰⁰⁶

1193. Furthermore, the Tribunal speculated by judging that the YNG auction was rigged. When that conclusion is stripped of the erroneous assumption that the YNG shares were allegedly sold for a price "*far below*" their fair market value - an assumption that is untenable because it is incompatible with the valuation of Yukos as a whole by the Tribunal - the overall conclusion of the Tribunal that the YNG auction was manipulated is only supported by the following two speculations:

- (a) The "suspicion" of the Tribunal that the winning bidder had been incorporated by the Russian Federation to facilitate the successive purchase of YNG by Rosneft:

"The additional evidence placed before this Tribunal connecting Baikal to Surgutneftegez does not erase the *suspicion* that Baikel was created by instruments of Respondent in order to facilitate the acquisition of YNG by State-owned Rosneft."²⁰⁰⁷ [emphasis added]

and

- (b) the conjecture by the Tribunal that, if Yukos had not obtained a court order that prevented potential bidders (and their financiers) from participating in the auction and Yukos would not have threatened everyone who would have taken part in the auction with a "*lifetime of litigation*", Yukos' fate "*would have been no different*" and this "*may have postponed*" Yukos' demise, but "*it would not have been avoided*".

"1625. (...)However, in the view of the Tribunal, Yukos' ultimate fate would have been no different if it had not threatened a lifetime of litigation or obtained a Temporary Restraining Order from a Texas Court. Its demise may have been postponed, or the path to its demise

²⁰⁰⁵ Writ, § 569-570, SoR, §§ 742-777 and §§ 823-824, DoA, §§ 1164-1171; Final Awards, marginal no. 1020.

²⁰⁰⁶ Writ, § 569-573, SoR, §§ 742-777 and §§ 823-824, DoA, §§ 1164-1171.

²⁰⁰⁷ Final Awards, marginal no. 1037.

altered in some minor way, but it would not have been avoided.²⁰⁰⁸
[underline emphasis and italics by counsel]

1194. This speculation amounts to a violation of the public policy, given the violation of the principle of hearing both sides of the argument, equality of arms, impartiality and an unbiased position.²⁰⁰⁹

G. Public Policy Ground 5 – HVY’s Fraud in the Arbitration Requires Set-Aside of the Yukos Awards on Public Policy Grounds

Essence of the argument

Because of the fraud committed by HVY during the Arbitrations, the Yukos Awards violate the public policy. After the Arbitrations, new material surfaced that demonstrates that HVY misled the Tribunal by submitting false statements and withholding documents relevant for the crucial issues in debate in the Arbitrations.

1195. It cannot be doubted that public policy and good morals demand condemning corrupt and fraudulent conduct and arbitral awards resulting from the same. This is true with respect to any civilized country’s domestic and international public policy. As a matter of public policy, “[a] judgment, which in principle calls for the greatest respect, will not be upheld if it is the result of fraud”.²⁰¹⁰ That is the case when an international tribunal has been “misled by fraud and collusion on the part of the witnesses and suppression of evidence on the part of some of them”.²⁰¹¹

²⁰⁰⁸ See SoRej. §§ 747-751; Final Awards, marginal nos. 1037, 1069 and 1625: “However, in the view of the Tribunal, Yukos’ ultimate fate would have been no different if it had not threatened a lifetime of litigation or obtained a Temporary Restraining Order from a Texas Court. Its demise may have been postponed, or the path to its demise altered in some minor way, but it would not have been avoided.” [emphasis added]

²⁰⁰⁹ HVY assert that the Russian Federation allegedly failed to explain how the shortcomings in the reasoning of the Tribunal constitute a violation of the principle of hearing both sides of the argument, or how these shortcomings indicates the bias of arbitrators and why that violation is contrary to public policy (see SoD, § 691). Wrongly so. Because, after all, the speculations are – as explained – not based on any evidence and parties have logically not been able to make statements about these speculations (which the Russian Federation could first read in the Final Awards) and the speculation in its own right already demonstrates the bias, such to the detriment of the Russian Federation in several respects.

²⁰¹⁰ Bin Cheng, General Principles of Law As Applied By International Courts and Tribunals (Cambridge University Press 2006), p. 159.

²⁰¹¹ Bin Cheng, General Principles of Law As Applied By International Courts and Tribunals (Cambridge University Press 2006), p. 159.

1196. On this basis, courts across jurisdictions have denied enforcement of awards – or have even set aside awards decades later²⁰¹² – that uphold claims that are based on fraudulent and corrupt conduct. For instance, in a recent case involving an application to enforce an award rendered under the ECT, the English Commercial Court found “*a sufficient prima facie case that the Award was obtained by fraud,*” and ordered the examination of such fraud on the ground that “[i]t will do nothing for the integrity of arbitration as a process or its supervision by the Courts (...), if the fraud allegations in the present case are not examined.”²⁰¹³
1197. In the instant case, the Yukos Awards are tainted with HVY’s misconduct during the Arbitrations. After the date of the Yukos Awards new material surfaced from proceedings between the associates of the Russian Oligarchs and between those associates and third parties that were in one way or another involved in the Yukos affairs. That material showed that HVY misled the Tribunal by submitting false statements and withholding documents relevant for the crucial issues in debate in the Arbitration. The most striking example is the fact that HVY were adamant in defending that the Russian Oligarchs had no control over HVY and that the trustees were in control. That such is untrue cannot be denied anymore. Documents that were therefore indeed in HVY’s control should have been disclosed, as is specified below.
1198. HVY, in many ways, actively defrauded the Tribunal with their submissions and ‘evidence’, and also, on numerous occasions, concealed directly relevant evidence from the Tribunal. Amongst others, the following aspects confirm the gravity of HVY’s misconduct during the Arbitrations:

²⁰¹² See, e.g. *United States v. La Abra Silver Mining Co.*, 32 Ct. Cl. 462 (1897) & *United States v. Weil*, 35 Ct. Cl. 42 (1900) (U.S. Court of Claims holding, 22 years after the awards had been rendered, that they had been obtained by fraud and that the United States should restore the payments received); *Lehigh Valley Railroad Company, Agency of Canadian Car and Foundry Company, Limited, and Various Underwriters (United States) v. Germany (Sabotage Cases)*, Opinion dated 15 June 1939, R.I.A.A. vol. VIII, p. 225, at 239, 458-459 (Mixed Claims Commission of the United States and Germany setting aside a decision based upon false and fraudulent evidence, while observing that “[n]o tribunal worthy its name or of any respect may allow its decision to stand if such allegations are wellfounded”); *Ram International Industries v. Air Force of Iran*, Iran-US Cl. Trib. Rep. vol. 29, 383, at 390, § 20 (1993) (Iran-United States Claims Tribunal observing that a tribunal “would by implication . . . have the authority to revise decisions induced by fraud”).

²⁰¹³ *Anatolie Stati and others v. The Republic of Kazakhstan*, Judgment dated 6 June 2017, [2017] EWHC 1348 (Comm) § 93: “*a sufficient prima facie case that the Award was obtained by fraud,*” and “[i]t will do nothing for the integrity of arbitration as a process or its supervision by the Courts (...), if the fraud allegations in the present case are not examined.”

- (a) The principal misrepresentation that HVY are guilty of, throughout the Arbitrations and even before this Court and during the first instance, is the concealment of their true relationship with the Russian Oligarchs and the pervasive criminality permeating their alleged Yukos investment. HVY's misrepresentations during the Arbitrations emanated primarily from their submissions and their direct violations of the Tribunal's document production order.
- (b) With respect to the evidently fraudulent breach of the Tribunal's document production order, it is notable that HVY did not disclose GML's 2011 letter regarding Mr. Brudno's agreement to pay secret kickbacks to, amongst others, Mr. Bruce Misamore and Mr. Michel de Guillenschmidt.²⁰¹⁴ These two men were the supposedly "independent" members of VPL's Voting Committee.²⁰¹⁵ These secret kickbacks gave the Russian Oligarchs (rather than the Jersey Trustee) a means of directly controlling VPL's decision-making. It was also significant that Mr. Brudno *himself* participated in negotiating this agreement, thus reflecting the Russian Oligarchs' direct control over Hulley and YUL (in circumvention of the Guernsey Trustees).²⁰¹⁶ The failure to disclose GML's 2011 letter unmistakably violated the Tribunal's Procedural Order No. 12, because this document was responsive to the Russian Federation's Document Request No. 7.5.²⁰¹⁷ Nor did HVY disclose any of the other responsive documents and communications which presumably must exist, based upon the Russian Oligarchs' course of conduct as described by their business associates, Mr. Godfrey²⁰¹⁸ and Mr. Wolf.²⁰¹⁹ As these two men have testified,²⁰²⁰ the

²⁰¹⁴ See GML 2011 Agreement disclosed 21 July 2015 (**Exhibit RF-321**) (describing 10% kickback agreement); Wolf Deposition dated 5 October 2015 (**Exhibit RF-322**) at 76-81 (describing US\$ 225 million disbursed, with a US\$ 25 million kickback paid under the 2011 kickback agreement); Feldman Amended Answer and Complaint 28 September 2016 (**Exhibit RF-302**) pp. 41-42.

²⁰¹⁵ Voting Instructions from VPL Voting Committee (C-1169; Veteran) (identifying Bruce Misamore and Michel de Guillenschmidt as members of the VPL Voting Committee, together with Platon Lebedev).

²⁰¹⁶ See GML 2011 Agreement disclosed 21 July 2015 (**Exhibit RF-321**).

²⁰¹⁷ See Procedural Order No. 12, § 211 (16 September 2011) (**Exhibit RF-3**), granting Respondent's First Merits Request For Documents, Request Nos. 7.5(a), 7.5(c), 7.5(d) dated 17 June 2011) (**Exhibit RF-323**).

²⁰¹⁸ Deposition of Mr. David Godfrey d.d. 7 June 2016 (**Exhibit RF-295**), p. 433.

²⁰¹⁹ Wolf Deposition dated 5 October 2015 (**Exhibit RF-322**) at 30-38, 120-145, and Annexes.

Russian Oligarchs directly and continuously participated in HVY's decision-making with respect to significant business transactions.²⁰²¹ HVY's failure to produce even a single document reflecting this relationship is thus highly suspect. Indeed, HVY failed to disclose the minutes of the two Dutch *Stichtings*,²⁰²² even though these documents were also subject to disclosure under the Tribunal's document production order,²⁰²³ and were admittedly in the possession, custody, or control of HVY and its agent (Mr. Tim Osborne).²⁰²⁴

- (c) Further, HVY also concealed documents regarding the full chain of transactions involving the Yukos shares, which concealment also veiled HVY's direct connection to the Russian Oligarchs and the Russian Oligarchs' illegal acquisition of the Yukos shares.²⁰²⁵ As reflected in a 2012 correspondence during the Arbitrations, including objections by the Russian Federation at that time,²⁰²⁶ HVY failed to comply with the Tribunal's document production order requiring production of all "*documents evidencing the full chain of Yukos' ownership, custody, and control since the time of Yukos' privatization through which (...) HVY acquired their holdings in Yukos.*"²⁰²⁷ The Tribunal's unfamiliarity with such directly relevant

²⁰²⁰ See *supra* III.C.

²⁰²¹ See *supra* III.C.

²⁰²² See Stichting Minutes 11 September 2008 (San Francisco) (*Feldman* ECF No. 62-6) (**Exhibit RF-325**); Stichting Minutes 11 December 2008 (New York) (*Feldman* ECF No. 62-5) (**Exhibit RF-326**); Stichting Minutes 9 March 2010 (Houston) (*Feldman* ECF No. 62-4) (**Exhibit RF-327**); Stichting Minutes 28 June 2011 (New York) (ECF No. 62-2) (**Exhibit RF-328**).

²⁰²³ See Procedural Order No. 12, § 211 (Sept. 16, 2011) (**Exhibit RF-3**), granting Respondent's First Merits Request For Documents, Request Nos. 7.5(a) (June 17, 2011).

²⁰²⁴ See Declaration of Tim Osborne re Minutes of the Stichtings of 21 October 2015 (*Feldman* ECF No. 68, (**Exhibit RF-324**)) ("*In the course of my service as a Foundation Director, I received copies of confidential Board of Director meeting minutes . . .*").

²⁰²⁵ See chapter III.B(a) above.

²⁰²⁶ Letter from Baker Botts LLP to Shearman & Sterling LLP dated 6 Feb. 2012, at 3 & n.2 (ECF 88-25) ("*Claimants have produced certain GML financial statements in response to request 4.2 . . . and (redacted) GML bank account statements in response to request 7.1 . . . These disclosures demonstrate that Claimants have access to documents from GML or its principals when Claimants desire. However, Claimants have not produced other responsive documents from GML or its principals. For example, Claimants have produced nothing in response to Respondent's requests 1.7 and 2.5 for documents concerning Yukos' chain of ownership since privatization.*").

²⁰²⁷ Procedural Order No. 12, § 140 (ECF No. 75-19): "*documents evidencing the full chain of Yukos' ownership, custody, and control since the time of Yukos' privatization through which (...) HVY acquired their holdings in Yukos.*"

evidence calls into question its assertion that its findings were based on “*the totality of the evidence*” and a “*review of the entire record*”.²⁰²⁸

- (d) In addition to this collusive and fraudulent concealment of documents, HVY’s misconduct also extends to making misrepresentative statements in their submissions to the Tribunal. HVY consistently advocated for a separation between themselves and the Russian Oligarchs,²⁰²⁹ and emphasized the legality of their acquisition of Yukos shares,²⁰³⁰ time and again – notwithstanding documents in their possession indicating otherwise. Indeed, as HVY fully appreciated at the time, the Russian Oligarchs’ acquisition of their shares through the LFS program through collusive and corrupt activities made that acquisition illegal and invalid under Article 6 of the LFS program and thus void.²⁰³¹ HVY thus went to great lengths to obscure and hide from the Tribunal the origins of their tainted shares.²⁰³²
- (e) As if the above were not sufficient indication of misrepresentative conduct, it has recently been revealed, during the discovery process in U.S. proceedings (discussed in greater detail below²⁰³³), that the Russian Oligarchs had made secret payments to Mr. Andrei Illarionov, one of HVY’s key witnesses in the Arbitrations. The Tribunal had regarded Illarionov as a “*reliable and convincing witness*”, basing a substantial portion of its decision on his testimony.²⁰³⁴ These secret payments, or “*donations*” as Mr. Godfrey calls it, have been explicitly confirmed by Mr. Godfrey in his deposition in these U.S. proceedings.

²⁰²⁸ Final Awards, marginal no. 1404; see chapter III.C(b) above.

²⁰²⁹ Claimants’ Skeleton Argument, § 32 (ECF No. 72-17).

²⁰³⁰ HEL Rejoinder on Jurisdiction and Admissibility, § 296 (ECF No. 71-16); Claimants’ Skeleton Argument, § 27 & fn. 19 (ECF No. 72-17).

²⁰³¹ Expert Report Prof. Asoskov 2015 (**Exhibit RF-203**) §§ 41-42; Decree of the President of the Russian Federation No. 889 (Aug. 31, 1995) (RME-7).

²⁰³² See generally Expert Report of Professor Kothari 2015 (**Exhibit RF-202**); Expert Report of Professor Kothari 2017 (**Exhibit RF-D15**).

²⁰³³ See §§ 1223-1221 below.

²⁰³⁴ Final Awards, marginal nos. 798-799.

1199. In light of the above, it becomes evident that HVY's conduct leading up to, and during the Arbitrations have made a mockery out of the Arbitrations that culminated in the Yukos Awards, rendering the Yukos Awards violative of good morals and public policy.

1200. The Court cannot close its eyes to such behavior, and let it sustain in The Netherlands by allowing the Yukos Awards to exist. Consequently, the Yukos Awards require to be set aside under Article 1065(1)(e) DCCP for their violation of public policy.

H. Public Policy Ground 6 – Enforcement of the Yukos Awards would violate Public Policy regarding Fraud, Corruption, and other Serious Illegality

Essence of the argument

The revival of the Yukos Awards would amount to legitimizing and upholding HVY's fraudulent, corrupt and illegal activities, which independently and in conjunction with the manner in which the Yukos Awards were rendered, would violate public policy.

1201. The manner in which the Tribunal rendered its findings as discussed above, i.e., in violation of the principles of the right to be heard as well as the equality of arms, and in a speculative, subjective and inconsistent manner, magnifies itself manifold in the direct impact these findings have on the ultimate outcome. This ultimate outcome of the Yukos Awards amounted to legitimizing and upholding HVY's fraudulent, corrupt and illegal activities, which independently – and certainly in conjunction with the manner in which the Arbitrations were conducted – violates the basic tenets of public policy and good morals as referred to in Article 1065(1)(e) DCCP.

1202. International practice is full of investment arbitration decisions where jurisdiction has been denied by tribunals over claims that are tainted with fraudulent or corrupt actions, or where such claims have been held to be inadmissible on grounds of violations of international public policy. A prominent example of a case where jurisdiction was so denied is *Inceysa v. El Salvador*, where the tribunal categorically stated the following:

"It is uncontroversial that respect for the law is a matter of public policy (...) If this Tribunal declares itself competent to hear the disputes between the parties, it would completely ignore the fact that, above any claim of an investor, there is a meta-positive provision that prohibits attributing effects to an act done illegally.

(...)

In light of the foregoing, not to exclude Inceysa's investment from the protection of the BIT would be a violation of international public policy, which this Tribunal cannot allow."²⁰³⁵

1203. A largely comparable conclusion was reached by the tribunal in the *World Duty Free v. Kenya* case, where the claims were rendered inadmissible on the ground that bribery is “contrary to international public policy of most, if not all, States or, to use another formula, to transnational public policy” and that “claims based on contracts of corruption or on contracts obtained by corruption cannot be upheld.”²⁰³⁶ Similarly, the tribunal in *Plama v. Bulgaria* held that granting ECT protections to “investment[s] (...) obtained by deceitful conduct,” would “be contrary to the basic notion of international public policy.”²⁰³⁷

1204. On the same basis, courts across jurisdictions have rejected the legal effect of an award if the very substance of the case, and consequently the substance of the tribunal's decision, is tainted by fraud, corruption, or other serious illegality.²⁰³⁸ Recently, in *Kyrgyz Republic v. Belokon*, the Court of Appeal of Paris set aside an award on public policy grounds because the claimant had engaged in money-laundering. In the underlying arbitration – much as in this case – the tribunal had acknowledged that such illegality, if proven, could be grounds for dismissal, but held that the respondent had not adequately proven its allegations.²⁰³⁹ In

²⁰³⁵ *Inceysa Vallisoletana, S.L. v. Republic of El Salvador*, ICSID Case No. ARB/03/26, Award, §§ 248-252: “It is uncontroversial that respect for the law is a matter of public policy (...) If this Tribunal declares itself competent to hear the disputes between the parties, it would completely ignore the fact that, above any claim of an investor, there is a meta-positive provision that prohibits attributing effects to an act done illegally. (...) In light of the foregoing, not to exclude Inceysa's investment from the protection of the BIT would be a violation of international public policy, which this Tribunal cannot allow.”; see also *Fraport AG Frankfurt Airport Services Worldwide v. Republic of the Philippines*, ICSID Case No. ARB/11/12.

²⁰³⁶ *World Duty Free Company v Republic of Kenya*, ICSID Case No. Arb/00/7, Award, § 157: “contrary to international public policy of most, if not all, States or, to use another formula, to transnational public policy” and that “claims based on contracts of corruption or on contracts obtained by corruption cannot be upheld.”

²⁰³⁷ *Plama Consortium Ltd. v. Republic of Bulgaria*, ICSID Case No. ARB/03/24, Award, § 143: “investment[s] (...) obtained by deceitful conduct,” would “be contrary to the basic notion of international public policy.”

²⁰³⁸ *Soleimany v Soleimany* [1998] APP.L.R. 02/19, § 48 (“Where public policy is involved, the interposition of an arbitration award does not isolate the successful party's claim from the illegality which gave rise to it.”).

²⁰³⁹ *Belokon v. Kyrgyzstan*, UNCITRAL, Award, §§ 158-59; see for a similar statement Final Awards, marginal nos. 1369-1370.

the annulment action, the Paris Court conducted an independent assessment and found that the respondent had, indeed, provided sufficient evidence of money-laundering.²⁰⁴⁰ The Appeal Court based its decision on the arbitration record, as well as new evidence submitted in the annulment proceedings.²⁰⁴¹ Accordingly, the Paris Court annulled the award, ruling that “*the recognition or enforcement of the award, which would have the effect of allowing [the investor] to benefit from the fruit of criminal activities, would violate in a manifest, effective and specific manner international public policy.*”²⁰⁴²

1205. HVY’s misconduct with respect to their alleged Yukos investment has been discussed in great detail above.²⁰⁴³ Accordingly, only the following will be reiterated with respect to this chain of illegal actions on part of HVY:

- (a) The illegal, fraudulent and corrupt conduct of Yukos and HVY, have since the Arbitrations,²⁰⁴⁴ until the first instance,²⁰⁴⁵ been categorized by the Russian Federation under 28 categories (encompassed within the four broad categories reflected above).²⁰⁴⁶ This conduct begins with the blatant corruption and rigging of the auctions in 1995-1996, carries on with a thread of illegal activities relating to the fraudulent tax evasion by money laundering and/or sham transactions, and culminates finally in the provocation of the Final Awards.
- (b) These 28 categories of illegal conduct by Yukos were recognized and reproduced in the Final Awards by the Tribunal.²⁰⁴⁷ The Tribunal also confirmed the illegalities and abuses characterizing some of the constituents of this list, including, *inter alia*, the sham-like nature of the operations in

²⁰⁴⁰ *République du Kirghizistan c. M. Valeriy Belokon*, Cour d’Appel de Paris, Pôle 1, Ch. 1, Judgment dated 21 Feb. 2017, at 9, 11, 15, 16.

²⁰⁴¹ *République du Kirghizistan c. M. Valeriy Belokon*, Cour d’Appel de Paris, Pôle 1, Ch. 1, Judgment dated 21 Feb. 2017, at 6, 10.

²⁰⁴² *République du Kirghizistan c. M. Valeriy Belokon*, Cour d’Appel de Paris, Pôle 1, Ch. 1, Judgment dated 21 Feb. 2017, at 15 (« *la reconnaissance ou l’exécution de la sentence entreprise, qui aurait pour effet de faire bénéficier M. BELOKON du produit d’activités délictueuses, viole de manière manifeste, effective et concrète l’ordre public international* »).

²⁰⁴³ See chapters III.B and III.C; see also chapter IV.C(c).

²⁰⁴⁴ Respondent’s Rejoinder on the Merits, §§ 1435-1436 (with references to the Counter-Memorial).

²⁰⁴⁵ SoR, § 28 (with references to the Counter-Memorial).

²⁰⁴⁶ See chapter III.B; see also chapter IV.C(c).

²⁰⁴⁷ Final Awards, marginal nos. 1283-1309, 1607.

Lesnoy and Trekhgorny,²⁰⁴⁸ and Yukos' fraudulent use of the Cyprus-Russia DTA for tax avoidance.²⁰⁴⁹ In fact, as discussed above, the ECtHR has also consistently and unanimously confirmed the intentional tax evasion by the Russian Oligarchs of Yukos.²⁰⁵⁰ The collusive nature of the Russian Oligarchs' bid-rotation scheme during the 1995-1996 privatizations, finally, was confirmed by the English High Court.²⁰⁵¹

- (c) Without sound reasoning the Tribunal has ignored many clear and egregious illegalities conducted by the Russian Oligarchs, Yukos and HVY, yet another conspicuous example being the tax fraud through the sham companies in Mordovia.²⁰⁵²
- (d) In closing its eyes to such illegalities, the Tribunal has also rendered internally contradictory findings on many occasions. For instance, as explained above,²⁰⁵³ HVY are neither “*separate from*” the Russian Oligarchs nor “*controlled by*” the trustees in Guernsey and Jersey,²⁰⁵⁴ as the Tribunal erroneously decided.²⁰⁵⁵ In so deciding, the Tribunal contradicted its own findings, since on other occasions it had stated that the Russian Federation's actions were “*actions against Mr. Khodorkovsky and Yukos*”,²⁰⁵⁶ or were aimed at “*removing Mr. Khodorkovsky from the political arena*”.²⁰⁵⁷ Notwithstanding the impropriety of this consideration, it cannot be doubted that these two findings, i.e., first, that HVY are separate entities from the Russian Oligarchs, and second, that the alleged expropriation of HVY were motivated against Mr. Khodorkovsky, are mutually inconsistent. These

²⁰⁴⁸ Final Awards, marginal nos. 488-494, 1611; see chapter III.B(c).

²⁰⁴⁹ Final Awards, marginal nos. 1616-1621; see chapter III.B(b); see also chapter IV.C(c).

²⁰⁵⁰ See chapter II.C(c)(iv) above; see also chapter IV.C(c).

²⁰⁵¹ See *Berezovsky v. Abramovich* Judgment, 31 Augustus 2012 (RME-4654) § 224. Also see Berezovsky Declaration (**Exhibit RF-225**, Annex R-266) § 121, Day 4, at p. 52 (“*Q. Menatep was a bank associated with Mr Khodorkovsky and Yukos, wasn't it? A. It is correct. Q. Did you agree with Mr Khodorkovsky in advance that his bid would be made at a slightly lower level than NFK's? A. It is correct.*”

²⁰⁵² See chapter VI.D above.

²⁰⁵³ See chapter III.C above.

²⁰⁵⁴ SoA §§ 806, 840.

²⁰⁵⁵ Final Awards, marginal nos. 1369-1370.

²⁰⁵⁶ Final Awards, marginal no. 1614.

²⁰⁵⁷ Final Awards, marginal no. 1404.

contradictory findings are irreconcilable with each other, and are a consequence of an improper, partial and perfunctory appraisal of the evidence on the record on part of the Tribunal.

1206. The Tribunal's ignorance of the pervasive fraud and corruption tainting the chain of HVY's conduct over a span of more than two decades (one of which was the duration of the Arbitrations itself) resulted in several casualties, including, in equal measures, the Russian Federation and the fundamental notions of public policy and good morals. These casualties ought to be remedied by this Court by setting aside the Yukos Awards under Article 1065(1)(e) on the grounds of violation of public policy, both as a matter of Dutch law and international law.

I. Conclusion: Yukos Awards are contrary to the public policy

1207. For any of the above reasons, or all of these reasons taken together, the Yukos Awards shall be set aside on the basis of Article 1065(1)(e) DCCP. The Arbitral Tribunal has violated the fundamental rights of the parties to hear both sides, to equal treatment and to an impartial and independent arbitral tribunal, as a result of which the Yukos Awards are contrary to the public policy. In the first place, the Russian Federation has not been given an opportunity to express its views on (a) the own damage calculation method of the Arbitral Tribunal and (b) the non-obtained advice of the Competent Tax Authorities. In the second place, the Arbitral Tribunal has unlawfully speculated about crucial decisions. In the third place, the Arbitral Tribunal has based decisions on purely own views on what the Russian law *should stipulate* instead of on what the Russian law *did actually stipulate*. In the fourth place, the opinion on the value of the YNG shares is inherently incompatible with the Arbitral Tribunal's own valuation of Yukos, while the decisions of the Arbitral Tribunal with regard to the YNG auction are based on incorrect assumptions and unacceptable speculation. In the fifth place, HVY's committed fraud and deceit in the Arbitrations and withheld documents. Finally, also the enforcement of the Yukos Awards would violate public policy due to fraud and corruption.

VIII. REMAINING ISSUES

A. Defence against several irrelevant biased allegations in the introduction of the Statement of Appeal

1208. HVY appealed against the District Court's correct ruling that the Arbitral Tribunal had no jurisdiction to adjudicate their claims. The first chapter of the Statement of Appeal starts with "*introductory remarks*" that apparently only serve to discredit the Russian Federation. These baseless and irrelevant remarks have no bearing on the appeal.

1209. HVY wrongly hold that this case would concern an "*unparalleled campaign of abuse of power, violence and intimidation*" by the Russian Federation.²⁰⁵⁸ In fact, HVY, the Russian Oligarchs and Yukos operated through *inter alia* fraud²⁰⁵⁹, corruption²⁰⁶⁰, violence (including murder and attempted murder),²⁰⁶¹ and tax evasion on a massive scale.²⁰⁶² As set out in chapter III above, several annulment grounds are directly related to this conduct of HVY and the Russian Oligarchs. Unlike HVY's unfounded allegations, this conduct is directly relevant for the assessment in these proceedings.

1210. HVY have not addressed the merits of these serious accusations. Instead, HVY assert (a) that the Russian Federation allegedly improperly influenced the judiciary in Armenia, (b) that the Russian Federation was allegedly responsible for the death of Mr Aleksanyan and manipulated witnesses, (c) that the Russian Federation allegedly exerted unauthorised diplomatic pressure, (d) that the Russian Federation allegedly unleashed "mass propaganda" and (e) that the Russian Federation was allegedly disingenuous in the proceedings in the first instance. Although each of these points is irrelevant to decide on the grievances in this case, the Russian Federation does not wish that those assertions remain unrefuted.

²⁰⁵⁸ SoA, § 3.

²⁰⁵⁹ See chapter III.B(a) above.

²⁰⁶⁰ See chapter III.B(a) above.

²⁰⁶¹ See chapter III.B(a) above and the Declaration of Mr. Rybin (**Exhibit RF-G3**).

²⁰⁶² See chapters III.B(b)-III.B(d) above. See e.g. Final Awards, marginal nos. 1620, 1633-1637 with regards to the Tribunal's indisputable findings that HVY evaded Russian dividend tax.

(a) *Allegations regarding the judiciary in Armenia*

1211. Without evidentiary support, HVY allege that the Russian Federation “*fully controls the judiciary*” in Yukos matters.²⁰⁶³ In that regard, HVY allege that the state-owned company Rosneft allegedly corrupted a legal action in Armenia.²⁰⁶⁴ The Russian Federation was not a party to those proceedings. However, it appears that HVY nevertheless intend to raise alleged manipulations in those Armenian proceedings to substantiate the claim that the Russian Federation allegedly “*manipulated the judiciary*” and played a questionable role in the collapse of Yukos Oil Company.²⁰⁶⁵
1212. HVY cannot in any way explain why the alleged manipulation of a legal action in Armenia – that would have occurred long after the bankruptcy of Yukos was resolved – is relevant to these present proceedings. They do not even argue that the Russian Federation had any involvement in said Armenian proceedings. Nor do they present any evidence that would justify such a conclusion. The news report on which HVY rely does reveal that Surik Ghazaryan, the Armenian judge allegedly pressured by Rosneft, has in fact “*received assistance from the Yukos camp, which is also supporting him financially.*”²⁰⁶⁶
1213. The absence of evidence that would show any improper conduct by the Russian Federation is underscored by the fact that HVY have gone on a discovery “*fishing expedition*” against Rosneft’s lawyers in two separate proceedings in the United States – one in Washington, DC, and another in California. In both proceedings, HVY have expressly argued that the purported evidence that they seek as to alleged misconduct in Armenia would be used in the appellate proceedings before this Court.²⁰⁶⁷ Responsive filings by Rosneft’s lawyers indicate that the Yukos parties also were accused of improperly manipulating the Armenian judiciary in the very same proceedings – and reiterate that the Yukos parties “*arranged*

²⁰⁶³ SoA, §§ 8-9.

²⁰⁶⁴ SoA § 9.

²⁰⁶⁵ SoA, §§ 8-9.

²⁰⁶⁶ Exhibit HVY-140.

²⁰⁶⁷ United States District Court for the District of Columbia, case no. 1:17-mc-01466-BAH, Application for § 1782 Order, 19 June 2017 (**Exhibit RF-294**), at 1 (“The evidence sought through this Application will allow the Court of Appeal of the Hague (“Dutch Appellate Court”) to fully and fairly assess the conduct of the Russian Federation in its dealings with foreign courts. In particular, Petitioners seek evidence relating to the Russian Federation’s efforts, both directly and through its agents, to interfere with and manipulate Armenian courts in order to obtain favourable judgments and influence related cases then pending in the Dutch courts.”).

rich compensation” for Judge Ghazaryan’s testimony.²⁰⁶⁸ Notably, the federal court in Washington, DC promptly rejected HVY’s discovery application and correctly ruled that the Armenia matters are not relevant to this Dutch appeal, including on the basis that HVY had “*failed to connect the dots between [the requested discovery regarding Armenia] and the Dutch appeal proceeding,*” and that, “*On these facts, the requested discovery would be of limited usefulness to the Dutch appeal proceeding, at best.*”²⁰⁶⁹

1214. HVY nonetheless persist – to date, without success – in their efforts to obtain discovery in California. They have even asked the DC court to reconsider its ruling rejecting their discovery application. It thus appears that HVY hope to dump further materials regarding the Armenia issues into this proceeding at some late stage, after the Russian Federation has filed its Defence on Appeal. In other words, HVY are working to prejudice the Russian Federation and to muddle these proceedings with unsupported and irrelevant allegations.

1215. The Russian Federation disputes that the Russian judiciary played a questionable role in the collapse of Yukos Oil. The collapse of Yukos Oil is the consequence of a mass tax fraud that (quite rightly) led to additional tax assessments. As discussed above, the ECtHR agreed with the assessment of dozens of Russian tax judges and concluded that those findings were sound.²⁰⁷⁰ In the many Yukos-proceedings in national courts and before the ECtHR no evidence was ever presented to the effect that the Russian courts were dependent or partial. In those instances in which bald allegations were made in this regard,

²⁰⁶⁸ United States District Court for the District of Columbia, case no. 1:17-mc-01466-BAH, Opp’n to § 1782 Application, 18 July 2017 (**Exhibit RF-294**) at 11 (“In that litigation [Dutch proceedings between Yukos managers and Rosneft], Rosneft also accused the Yukos Managers of improperly interfering with the Armenian judicial proceedings. It was also established, *inter alia*, that the Yukos Managers arranged rich compensation for an Armenian Judge, Surik Ghazaryan, in exchange for providing, and not altering or changing, his testimony.”) (internal citations omitted).

²⁰⁶⁹ United States District Court for the District of Columbia, case no. 1:17-mc-01466-BAH, Order Denying Application, 18 August 2017 (**Exhibit RF-294**) at 10 “*With respect to the relevance of the requested discovery to the Dutch appeal proceeding, the petitioners [HVY] emphasize the discovery could ‘lead to evidence of the Russian Federation’s manipulation of a foreign court to influence the outcome of a then-pending Yukos matter,’ Appl. at 10, but fail[] to connect the dots between this evidence and the Dutch appeal proceeding, which involves questions of jurisdiction in no way implicating the Russian Federation’s conduct, as well as events culminating in 2007, years before the conduct in 2010 and 2011 giving rise to the petitioners’ discovery request (...)* On these facts, the requested discovery would be of limited usefulness to the Dutch appeal proceeding, at best.”

²⁰⁷⁰ See First ECtHR decision § 594 (RME-3328).

these were rejected by the ECtHR as "*manifestly unfounded*".²⁰⁷¹ In the Dutch legal proceedings, similar unsubstantiated complaints have consistently been rejected.²⁰⁷²

1216. In reality, HVY have "manipulated *the judiciary*", also in this particular case.²⁰⁷³ As explained above, the Russian Yukos Oligarchs have previously also disturbed the proper administration of justice in the Russian Federation. For example, they have destroyed relevant evidence on a large scale.²⁰⁷⁴

(b) *Allegations with regard to Mr. Aleksanyan and the alleged manipulation of witnesses*

1217. The most far-reaching – yet irrelevant – accusation made by HVY concerns the death of Mr Aleksanyan, Yukos Oil Company's former head of legal affairs. HVY assert that he "*died (...) as a result of complications that had occurred due to his inhuman treatment and the circumstances in which he had been detained.*" HVY hold the Russian Federation responsible for Mr Aleksanyan's death.²⁰⁷⁵

1218. Mr. Aleksanyan was held in pretrial detention until 2009 on charges of embezzlement, tax evasion, and money laundering arising from his involvement in various Yukos criminal schemes. He regrettably died of AIDS in 2011, more than two years after his early release on humanitarian grounds. Mr. Aleksanyan had already contracted HIV prior to his pretrial detention, presumably as the result of a blood transfusion after a car accident.²⁰⁷⁶ Nonetheless, HVY make a number of false allegations that are readily refuted:

²⁰⁷¹ See ECtHR 23 October 2012, case. 38623/03 (*Pichugin v. Russische Federatie*), §§ 181-183.

²⁰⁷² HVY cannot rely on the decision of the Court of Appeal of Amsterdam, 28 April 2009, ECLI:NLGHAMS:2009:BI2451. This decision has been reversed on multiple occasions, see Court of Appeal Amsterdam 27 September 2016 ECLI:NL:GHAMS:2016:3911 (*Maximov/NLMK*), rov. 2.2.1 Court of Appeal Amsterdam 9 May 2017, ECLI:NL:GHAMS:2017:1695 (*Godfrey. c.s./Promneftstroy*), rov. 4.15.1. On the recognition of Russian judgments see Supreme Court 26 September 2014, ECLI:NL:HR:2014:2838 which shows that Russian judgments are recognizable. Also see Court of Appeal The Hague, 9 February 2016, ECLI:NL:GHDHA:2016:280.

²⁰⁷³ With regard to the clearly inappropriate attempt of HVY to influence the Belgian courts by engaging a member of the judiciary to provide a legal opinion on the merits of these proceedings, see Supreme Court 30 June 2017, ECLI:NL:HR:2017:1188.

²⁰⁷⁴ See chapter III.B(d) above.

²⁰⁷⁵ SoA, §10.

²⁰⁷⁶ See *Obshchaya Gazeta* dated 7 October 2011, 'Former Vice-President of YUKOS Vasily Aleksanyan was buried in Khovanskoye Cemetery' (**Exhibit RF-411**).

- “*In violation of the most basic human rights the Russian Federation refused to provide the necessary medical aid, unless he falsely testified against Mr Khodorkovsky.*”²⁰⁷⁷ In fact, the ECtHR concluded in its judgment that Mr. Aleksanyan was permitted access to anti-retroviral medicines as early as July 2007²⁰⁷⁸ (if not much earlier),²⁰⁷⁹ and while still in detention was transferred to a specialized hospital for HIV-related treatment in February 2008.²⁰⁸⁰
- “*The Russian Federation ignored the ECtHR’s orders for some time, but Mr Aleksanyan was ultimately released (...).*”²⁰⁸¹ To the contrary, the Russian Federation released Mr. Aleksanyan shortly after the ECtHR judgment.²⁰⁸²
- “[H]is health had deteriorated in such a serious way that he eventually, after his release from prison in 2011, died from his illness that was complicated by the inhuman treatment and conditions during his detention.”²⁰⁸³ In fact, Mr. Aleksanyan was released in January 2009, not 2011. He lived with his family for another two years and ten months before passing away from his pre-existing illness in October 2011.²⁰⁸⁴

1219. Thus, contrary to HVY’s distortions of publicly-available facts, the record plainly reveals that Mr. Aleksanyan’s death was not caused by his pretrial detention, let alone some effort

²⁰⁷⁷ HVY SoA § 10.

²⁰⁷⁸ ECtHR, *Aleksanyan v. Russia* (Request no. 46468/06), judgment of 22 December 2008 §§ 145-150 (Exhibit HVY-142).

²⁰⁷⁹ ECtHR, *Aleksanyan v. Russia* (Request no. 46468/06), judgment of 22 December 2008 § 149 (Exhibit HVY-142) (“[A]s follows from the applicant’s medical file, he did not depend on the pharmacy’s stock and could receive necessary medication from his relatives. The applicant did not allege that procuring those medicines imposed an excessive financial burden on him or on his relatives In such circumstances the Court is prepared to accept that the absence of the anti-retroviral drugs in the prison pharmacy was not, as such, contrary to Article 3 of the Convention.”).

²⁰⁸⁰ ECtHR, *Aleksanyan v. Russia* (Request no. 46468/06), judgment of 22 December 2008 § 158 (Exhibit HVY-142).

²⁰⁸¹ HVY SoA § 10.

²⁰⁸² The ECtHR judgment was rendered on 22 December 2008 (Exhibit HVY-142). Aleksanyan was released three weeks later, *see, e.g.*, BBC, *Aleksanyan is discharged from the hospital*, 16 Jan. 2009 (**Exhibit RF-412**).

²⁰⁸³ HVY SoA § 10.

²⁰⁸⁴ *See, e.g.*, Ellen Barry, New York Times, 3 Oct. 2011, *Former YUKOS Lawyer Dies*, available at <http://www.nytimes.com>, last consulted November 2017.

by the Russian Federation to compel his testimony. In fact, the Russian Federation made considerable efforts both to provide Mr. Aleksanyan with the necessary medical treatment.

1220. HVY assert that the Russian Federation manipulates witnesses.²⁰⁸⁵ That is a peculiar allegation, given the fact that the Russian Federation did not introduce any witnesses in the Arbitrations to be examined. If anything, this case has seen improper handling and manipulation of witnesses by HVY. As noted above, Yukos parties "*arranged rich compensation*" for the testimony of the Armenian judge on which HVY now predicate their allegations about Armenian proceedings.²⁰⁸⁶

1221. It was recently revealed, during discovery in a U.S. lawsuit, that the Oligarchs made secret payments for Mr. Andrei Illarionov, one of HVY's key witnesses in the Arbitrations. The Tribunal regarded Mr. Illarionov a "*reliable and convincing witness*". As a result, the Tribunal explicitly based its decision on his testimony to the detriment of the Russian Federation.²⁰⁸⁷ The Russian Federation contested his statements on substantive grounds and adduced evidence thereto.²⁰⁸⁸ The Russian Federation also demonstrated Mr. Illarionov was a "phantast" who has publicly embraced several conspiracy theories.²⁰⁸⁹

1222. Mr. Godfrey (then a member of the Yukos Oil Board of Directors) has meanwhile confirmed under oath during a U.S. litigation deposition that Mr. Illarionov requested and received payment in exchange for his witness testimony for HVY in the Arbitrations:

"Q. Was Andrey Illarionova ever paid any money?

A. We made a contribution to somebody. I would have to go back and look, but some part of the organization made a contribution to the project at the Cato Institute with which he was involved.

²⁰⁸⁵ SoA, § 10.

²⁰⁸⁶ United States District Court for the District of Columbia, case no. 1:17-mc-01466-BAH, Opp'n to § 1782 Application, 18 August 2017 (**Exhibit RF-294**), at 11.

²⁰⁸⁷ Final Awards, marginal nos. 798-799.

²⁰⁸⁸ See Respondent's Post-Hearing Brief (**Exhibit RF-3**), § 205(i). Also see the witness statement of Mr. Burutin (**Exhibit RF-222**). Mr. Burutin clarifies that Mr. Illarionov was not holding a position as "*Chief Economic Advisor to the President*" at the time. Mr. Illarionov complained that he had not enough access to the president as an advisor. Illarionov's expertise was restricted to general economic and environmental matters. The tax assessments, actions, and criminal measures towards Yukos were did not fall within his range of duties and he therefore had no access to these documents.

²⁰⁸⁹ SoR, footnote 968. For example, after President Putin had not been seen in public for a week in March 2015, he informed the media that a coup had been staged in close cooperation with the Russian Orthodox Church.

(...) Q. What was the reason for making a donation to a place where Mr. Illarionov was working? (...)

A. He asked for it.

Q. And what services, if any, did he provide to Yukos in exchange for that donation?

A. I wouldn't say he provided any services to Yukos in exchange for that donation.

Q. So why did Yukos make a donation at the request of Mr. Illarionov?

A. Well, I would have to go back and look at the reasons he made a request and we agreed to it. I mean, he did provide -- I'd have to go back and look -- I think it's some sort of expert testimony if my memory serves me right.²⁰⁹⁰

1223. Mr Illarionov was a fact witness, not an expert, in the Arbitrations. He did not request the Tribunal for compensation or reimbursements. He did solicit and receive payment from Yukos-entities in exchange for his testimony. Neither he nor HVY disclosed any such arrangement during the course of the Arbitrations.

(c) *Allegations on purported inappropriate diplomatic pressure*

1224. HVY assert that the Russian Federation exercised inappropriate diplomatic pressure to prevent the enforcement of the set-aside Final Awards.²⁰⁹¹ With respect to France and Belgium, HVY adduce that the diplomatic pressure would somehow “*make clear that the Russian Federation does not have any respect for the independence of the judiciary in these countries.*”²⁰⁹² There was never any inappropriate diplomatic pressure, nor were there any attempts to press for the introduction of legislation.²⁰⁹³ Of course, the Russian Federation resisted unjustified attachments, and – for that purpose – was involved in customary communication.

²⁰⁹⁰ Statement of Mr Godfrey, Exhibit RF-295, p. 268-270.

²⁰⁹¹ SoA, § 11.

²⁰⁹² SoA, § 11.

²⁰⁹³ In Belgium, it was YUL that complained of the enactment of a new Article 1412 *quinquies* of the Belgian Judicial Code ("Gerechtelijk Wetboek") and introduced a request for annulment of this provision before the Belgian Constitutionnal Court ("Grondwettelijk Hof"). With a limited exception, the Belgian Constitutionnal Court rejected YUL's annulment request in its entirety and confirmed that Article 1412 *quinquies* was compatible with the Belgian Constitution and with the established principles of international public law. The Russian Federation was not involved in these proceedings.

1225. YUL *inter alia* attached assets such as the current accounts of the Russian Federation's Embassy in Belgium, while Hulley targeted assets in France with a public function: a Russian Orthodox cultural and spiritual centre. It is common knowledge that such assets are immune from attachments. YUL and Hulley apparently hoped to provoke a reaction in order to be able to publicly label those reactions as "unauthorised diplomatic pressure".
1226. It is not uncommon that attachments give rise to some form of diplomatic contacts between States. States have mutually agreed that it is not allowed to attach goods such as the embassy's bank account or the ambassador's residence. In those cases where attachments are imposed in a manner contrary to immunity from execution, the States concerned will take action. If, for example, assets of a foreign State are attached in the Netherlands, it is very common practice that the Dutch authorities will oppose the attachment or a future attachment.²⁰⁹⁴ Similar arrangements exist in other States, such as Belgium²⁰⁹⁵ the United States and Ghana.²⁰⁹⁶
1227. In any event, diplomatic consultations cannot lead to the lifting of attachments. In all States in which HVY have imposed attachments, the independent national courts decided on the lawfulness of the attachment and the enforcement of the Final Awards. Abiding by applicable laws and procedures, the Russian Federation challenged the attachments in each jurisdiction through the judicial process. YUL and Hulley have raised, to no avail, the same baseless allegations about political pressures in such proceedings. HVY's attempts to link purported diplomatic pressure to an alleged lack of respect for the judiciary must fail.

²⁰⁹⁴ In this context see the provisions of Article 3a of the Bailiff's Act. For a recent example, see Supreme Court 30 September 2016, *NJ* 2017/190 where the State involved, Gabon, had failed to appear, but where the State of the Netherlands opposed the attachment. About the role of the Dutch state in attachments imposed in the Netherlands see: A.G.F. Ancery en M.A.M. Essed, 'Staatsimmunititeit van executie', [State immunity from enforcement] *MvV* 2015/2.

²⁰⁹⁵ In Belgium, for example, the Belgian State intervened in the attachment proceedings introduced by YUL in order to support the Russian Federation's opposition against the enforcement measures taken by YUL. In order to avoid that the Russian Federation's immunity from execution would be violated, the Belgian State took efforts to avoid the wrongful enforcement measures, including the sale of real estate..

²⁰⁹⁶ On the U.S. see e.g. *BG Group v. Republic of Argentina*, U.S. Supreme Court, Judgment dated 5 March 2014 (**Exhibit RF-413**) reflecting the U.S. Solicitor General's submission in favor of the Argentine Government in proceedings to annul an investor-State arbitral award), On Ghana, see *NML Capital v. Republic of Argentina*, Supreme Court of Ghana, Judgment dated 20 June 2013 (**Exhibit RF-414**), reflecting the Ghanaian Attorney General's request that the Supreme Court of Ghana confirm the release of an Argentine ship entitled to sovereign immunity."

1228. Numerous judgments have meanwhile been handed down on HVY's attempts to enforce the Yukos Awards. The Russian Federation has – also before the judgment of the District Court of The Hague – won all these legal actions. All imposed attachments have been lifted.
1229. After the Final Awards were set aside, HVY stopped their (already unsuccessful) attempts to enforce these awards in most jurisdictions. Only in France and Belgium did Hulley and YUL continue proceedings until the judges in those cases rendered decisions that were unfavourable for them. On 8 June 2017, the Brussels Court ruled - despite YUL's many substantive objections - that the Judgment of the The Hague District Court should be recognised in Belgium and that, as a result, all attachments must be lifted.²⁰⁹⁷ YUL subsequently withdrew the proceedings in Belgium, waiving its right to seek enforcement in Belgium. In France, the Cour d'Appel in Paris, in an interim ruling of 27 June 2017, proposed to submit requests for preliminary rulings to the European Court of Justice regarding the interpretation of Article 45 ECT. Rather than await the answers to these questions, Hulley opted to withdraw the proceedings in France.²⁰⁹⁸
1230. The conclusion is that the Russian Federation was right to challenge HVY's attempts to enforce the Final Awards. This in no way supports HVY's allegations of purportedly improper diplomatic pressures or disregard for foreign courts. There was no undue political pressure nor disregard of foreign courts. In fact, HVY portrayed a lack of respect for the judiciary. A clear example concerns the immediate response the Russian Oligarch Michael Khodorkovsky to the decision of the District Court in an interview with the *London Evening Standard*. He claimed the judgment of the District Court was part of a Western political plan aimed at improving the relation with the Russian Federation.²⁰⁹⁹

²⁰⁹⁷ Judgment of the Brussels Court dated 8 June 2017 (**Exhibit RF-296**): "*Or, le jugement d'annulation tel qu'ici reconnu pour effet d'anéantir l'une de ces composantes essentielles. (...) Nous ne pouvons dès lors que constater qu'à ce jour, compte tenu de la force obligatoire de ce jugement ainsi reconnu, YUL ne dispose plus d'un titre exécutoire (...) (...) Il se justifie, en conséquence, d'ordonner la mainlevée de la saisie litigieuse.*"

²⁰⁹⁸ Given the clear position of the European Commission, the Council and the then Member States of the European Union, there can be no doubt that the interpretation advocated by the Russian Federation is correct (see chapter II.B(d) above).

²⁰⁹⁹ London Evening Standard, "Russia targets oligarchs over tax in \$50 billion Yukos legal feud", 11 May 2016, available at standard.co.uk, last consulted in July 2017: "*Khodorkovsky even suggested after the recent Hague ruling that the Dutch court was acting as part of a western political plan to relax the post-Crimea pressure on Moscow.*"

(d) *Allegations relating to alleged mass propaganda*

1231. HVY assert that the Russian Federation allegedly uses "*mass propaganda*". The Russian Federation allegedly "*secretly*" coordinate propaganda via organisations such as the "*International Center for Legal Protection*".²¹⁰⁰ Once again, even on their face, these unsubstantiated allegations have simply no bearing whatsoever on the legal issues before this Court, and should be ignored. Moreover, these assertions are incorrect.
1232. The International Center for Legal Protection (ICLP) was formed by the Institute of Legislation and Comparative Law and the Institute of State and Law of the Academy of Sciences of the Russian Federation. It is retained by the Ministry of Justice of the Russian Federation and is charged with coordinating the all legal actions related to Yukos. HVY's assertion that this organisation was secretly formed or operates secretly is an intentional lie. The organisation has a website (www.yukoscase.com) which is publicly accessible and which clearly describes its role.²¹⁰¹ Possible press releases are openly provided on that website.
1233. Mr. A. Kondakov, director of the *International Centre for Legal Protection*, operates in all openness.²¹⁰² For example, he personally attended the hearing of the The Hague District Court on 2 February 2016 and many other court hearings related to Yukos in various jurisdictions. For example, his presence had been announced in a letter of 26 January 2016 to the cause-list judge, the court clerk and the lawyers of HVY. The specific letter stated: "*on behalf of the Russian Federation, the following persons will be present: the undersigned (Professor A.J. van den Berg (counsel) and Messrs A. Kondakov and M. Vinogradov.*" After the hearing in the first instance, Mr. A. Kondakov took ample time to speak to the journalists assembled there.

²¹⁰⁰ SoA, § 11.

²¹⁰¹ See <https://www.yukoscase.com/about-iclp/>, last consulted in November 2017.

²¹⁰² If, for example, Mr A. Kondakov talks to the media, he clearly states his position. For example, on the website of the Global Arbitration Review on 26 August 2016, an article on the current proceedings was published in which Mr Kondakov explained that the massive tax evasion by Yukos Oil Company was inadmissible and justifiably gave rise to additional tax assessments (the article is available at www.globalarbitrationreview.com). The first paragraph of the newsletter is as follows: "*Andrey Kondakov is the director general of the International Centre for Legal Protection, which was set up by the Russian department of justice to fight the Yukos shareholders' in their effort to secure US\$50 billion damages from the state in line with a 2014 arbitral award that was recently set aside. Here, he argues why Russia has justice on its side.*"

1234. The assertion that the *International Centre for Legal Protection* is involved with “mass propaganda” is incorrect. The reality is that the ICLP fully adheres to the principles of openness and transparency. Despite its very limited manpower to talk to or approach the press ICLP believes that one of his duties is to respond to all press requests and enquires taking into account great public interest generated by the Yukos arbitrations and enforcement proceedings against the Russian Federation.

1235. The Russian Oligarchs themselves – ever since they took control of Yukos Oil – have continuously spent huge amounts of money to influence the public opinion. In the Arbitrations and in the civil proceedings in the first instance, the Russian Federation has already asserted, undisputed, that the Russian Oligarchs have launched a massive propaganda campaign in order to misrepresent this case.²¹⁰³ The main strands of their strategy were as follows.

- (a) From 2001 onwards, the Russian Oligarchs deployed a PR strategy to convey the impression as if Yukos was a modern and transparent company. Thereto, they purportedly implemented a number of *corporate governance* reforms. As the Tribunal found, these claims on modern and transparent governance were a “*façade*”.²¹⁰⁴
- (b) After the Yukos tax fraud was discovered mid-2003, the Oligarchs launched a media blitz. The Russian Oligarch Leonid Nevzlin personally made £ 37 million available for the first phase of the project. The funds were reserved to deliberately disseminate false information with the sole objective of discrediting the Russian Federation and its officials.²¹⁰⁵

²¹⁰³ Writ, § 31, C-Mem., § 780, footnotes 1279-1281.

²¹⁰⁴ Final Awards, marginal 1809 (“As Respondent rightly points out, Yukos’ claim of corporate governance reforms, Western standards of transparency and protection of minority interests, which Mr. Kaczmarek highlighted in his first report (and which was a recurring theme heard from Claimants in this case), “was a façade.”); *see also, e.g.*, Gololobov Declaration (**Exhibit RF-G2**), Lucy Komisar, *Yukos Kingpin on Trial*, CorpWatch (May 10, 2005) (RME-121) and New York Times 18 August 2001, Sabrina Tavernise, Fortune in hand, Russian tries to polish image, available at <http://www.nytimes.com/2001/08/18/business/international-business-fortune-in-hand-russian-tries-to-polish-image.html?pagewanted=all>, last consulted in July 2016 (“Mr. Khodorkovsky sat under a sign saying “Honesty, Openness, Responsibility” in late June to discuss the company’s latest financial results with reporters with an air of friendly candor. It was quite a performance, particularly for a man who two years earlier orchestrated a series of flagrant corporate abuses of minority shareholders unparalleled in the short history of modern Russian capitalism, setting what one Moscow brokerage firm called a benchmark for unacceptable behavior.”).

²¹⁰⁵ Article in The Sunday Times dated 14 May 2006 (**Exhibit RF-297**), (“The campaign was authorised by Nevzlin who told ISC to do “the biggest investigation ever”, according to a company insider. ISC drafted

- (c) The 2003 media campaign went hand-in-hand with an astronomical expenditures on lobbying activities. Many millions of dollars were spent across multiple jurisdictions to lobby for pro-Yukos causes. For example, by handsomely compensating leading former politicians to serve as “advisors”.²¹⁰⁶ Among them, the Oligarchs have engaged well-known Dutch politician and (former) European Commissioner, Frits Bolkestein.²¹⁰⁷ Bolkestein has repeatedly made public pronouncements incriminating the Russian Federation.²¹⁰⁸

1236. It thus follows that HVY’s claims as to a “*mass propaganda*” are both irrelevant and unsubstantiated. In fact, the Russian Oligarchs themselves have actively strived to sway public and judicial opinion through the dissemination of false information. This case

a 12-page document marked "Secret", which one of its partners presented to Nevzlin in Israel. The oligarch authorised £ 37m for the first phase of the operation, the source said. The plan was to mount a "sensitive and delicate" worldwide operation, feeding false or compromising information to journalists and governments about Putin - referred to as "X" - and his associates. The plotters wanted "(Putin) to be removed from power" but the more realistic objective was to force him to release Khodorkovsky from detention by March 2004 and cut Yukos's £ 5 billion tax bill. The document shows that besides Putin, Sergei Ivanov, the defence minister, was to be smeared with allegedly com-promising photographs. Other targets included key figures in state-owned energy companies."). The campaign would take years. For a long time the Russian Yukos Oligarchs have, with the help of their advisor APCO, posted purported "news items" on websites, such as those of *The New York Times*. See e.g. 'Yukos Shareholder Behind Ads Feeding Trial News to Policy Makers' 31 March 2005, available at <http://techpresident.com/content/yukos-shareholder-behind-ads-feeding-trial-news-policy-makers>.

²¹⁰⁶ See, e.g., Writ, § 31; Lucy Komisar, Corpwatch.org, 10 May 2005, *Yukos Kingpin On Trial* (RME-0121) (describing the Oligarchs’ lobbying strategy and public relations campaign, "Spinning Khodorkovsky"); BBC News dated 31 October 2003, "*Yukos advisers plan lobby offensive*", available via www.bbc.co.uk, last consulted in November 2017, showing that Yukos Oil Company had engaged a number of leading former politicians, including a former US Secretary of State (Mr Stuart Eizenstat), a former German Minister (Mr Otto Graf Lambsdorf) and a former Member of British Parliament (Mr J. Dudley Fishburn).; Group Menatep Announcement, Group Menatep Appoints International Advisory Board, 17 Apr. 2003 (Annex C-1237) (naming the members of the GML Limited International Advisory Board); Letter from GML Limited International Advisory Board to Khamovniki District Court of Moscow, 3 Nov. 2009 (in which the members of the International Advisory Board lobby on behalf of Oligarch Platon Lebedev) (**Exhibit RF-415**).

²¹⁰⁷ See for example the news article about this in Dutch newspaper De Volkskrant of 24 May 2005, titled "*Bolkestein advisor of Yukos’ parent company*". Available at www.volkskrant.nl, last consulted in November 2017. This was a highly controversial appointment: shortly before that, Bolkestein, in his capacity of European Commissioner, had blocked an investigation into the embezzlement of IMF funds by the Russian Oligarchs in the so-called 'Clearstream scandal'.

²¹⁰⁸ See for example the news article of 28 August 2006 in Dutch newspaper Trouw, '*Bolkestein advises against investing in Russia*', available at www.trouw.nl. On 19 June 2006 Bolkestein expressed his opinion of the Yukos case on Dutch national television, in news program NOVA and he advised against making further investments in the Russian Federation (available at www.ntr.nl).

should be decided on the basis of the evidence. Unsubstantiated opinions, insinuations, and misinformation should not be considered.²¹⁰⁹

(e) *Allegations on purported disingenuous statements*

1237. Forensics expert Professor S.P. Kothari has performed a meticulous forensic analysis of Yukos' shareholder registry, which adds up to more than 32.000 pages. He demonstrates that 100% of HVY's Yukos shares originated with the Russian Oligarchs' illegal activities in 1995 and 1996.²¹¹⁰ Tellingly, HVY offer no substantive response to Professor Kothari's forensic analysis of the Yukos share registry. Instead, they seek to distract through baseless arguments that the Russian Federation would have misled the District Court.

1238. HVY accuse the Russian Federation that its counsel allegedly took a "*disingenuous position*" regarding the shareholder registry of Yukos Oil Company and that this would showed that "*the Russian Federation cannot be trusted as a party in these proceedings*".²¹¹¹ During the hearing in the first instance, HVY had raised a number of procedural arguments to convince the District Court to remove relevant evidence from the record, including the expert report of prof. Kothari. In this context, the Russian Federation's counsel indicated in his oral reply that the Russian Federation was previously unsuccessful to access the shareholders' registers of Yukos Oil Company, as it was "*coded*". Unlike HVY presently and wrongly assert, it was never adduced that the files were "*encrypted*" (e.g. with a password).

1239. The rectitude of counsel's explanation at oral argument before the District Court is confirmed by the testimony of Colonel Mikhailov. Colonel Mikhailov led the criminal investigation into the tax fraud committed by Yukos. He testifies that, during the Yukos criminal investigation, investigators seized a computer on which the shareholder registry was stored. The technical capabilities and the necessary software to access the share

²¹⁰⁹ See the First ECtHR Ruling (RME-3328). The ECtHR held: "*665. Regard being had to the case file and the parties' submissions, including the applicant company's references to the allegedly political motivation behind the prosecution of the applicant company and its owners and officials, the Court finds that it is true that the case attracted massive public attention and that comments of different sorts were made by various bodies and individuals in this connection. The fact remains, however, that those statements were made within their respective context and that as such they are of little evidentiary value (...)*".

²¹¹⁰ Expert Report Prof. Kothari 2015 (**Exhibit RF-202**), § 45; Expert Report Prof. Kothari 2017 (**Exhibit RF-D15**), § 83.

²¹¹¹ SoA, §§ 12 and 847.

registry were however unavailable at the time (*legacy problem*). Thereto, a sophisticated software program was required (*Novell NetWare 3.12*). It was not until October 2015, when investigators first gained access to the electronic share registry.²¹¹²

1240. Further, Professor Kothari explains in his second expert report that there are numerous methods to “disguise and conceal” financial transactions, “such that the underlying movements of funds or assets cannot be deciphered or ‘readily accessed’ without considerable effort and detailed analysis.”²¹¹³ In the case of the Yukos registry Professor Kothari concludes, HVY’s principals relied on at least two different methods – the use of (shell) companies that nominally hold the shares and the use of smaller structured transactions (or “smurfing”). These methods serve to disguise the names of the actual owners and obscure the underlying transfers of shares. As a result, “the information in the YUKOS share registry was effectively encoded.”²¹¹⁴ The Court could easily verify this conclusion, by evaluating the Yukos registry itself.
1241. Given these efforts to conceal the ownership and control over Yukos shares, HVY’s cannot maintain in good faith that the Russian Federation has somehow been “guilty of deception”. These accusations are without merit.

IX. EXHIBITS, OFFER OF PROOF AND CONCLUSION

A. Exhibits and Offer of Proof

1242. In support of its arguments, the Russian Federation has in the first instance submitted the exhibits listed in the Writ of Summons, including the documents submitted in the Arbitrations (**Exhibits RF-1 - RF-95**). With the Statement of Reply, and prior to the Memorandum of Oral Pleading, additional exhibits have been submitted in the proceedings (**Exhibits RF-96 - RF 199 respectively Exhibits RF-200 - RF-226**). With this Defence on Appeal, additional exhibits are submitted in the proceedings (**Exhibits RF-227 - RF-415**).

²¹¹² Declaration of Colonel of Justice S.A. Mikhailov (**Exhibit RF-G4**) §§ 13-17.

²¹¹³ Expert Report Prof. Kothari 2017 (**Exhibit RF-D15**), § 14.

²¹¹⁴ Expert Report Prof. Kothari 2017 (**Exhibit RF- D15**), §§ 15-16.

1243. The Russian Federation has also provided proof in the Arbitrations, in the first instance and in the current proceedings by submitting expert reports and written statements (amongst others **Exhibits RF-D1 - RF-D22 and RF-G1 - RF-G5**).
1244. The Russian Federation maintains its offer of proof made in the first instance. The Russian Federation has cited multiple witnesses and has offered to provide proof several times. In so far as required, the Russian Federation at this point also offers (rebutting) proof, in particular by the hearing of witnesses, of all its arguments in this Defence on Appeal in so far as these are contested by HVY.
1245. Chapter II: the Russian Federation offers proof of its arguments in section II.C-II.E of this Defence on Appeal by hearing witnesses, including Mr. Katrenko. Mr. Katrenko can in particular testify that it was commonly known and publicly confirmed multiple times at the time that parts of the ECT (including Article 26 ECT) are contrary to Russian law.
1246. Chapter III: this chapter summarizes the Russian Oligarchs' twenty-eight individual instances of criminal, unlawful, and bad faith conduct. In most instances, the evidence is so overwhelming that HVY have not even denied the serious allegations against them. The Russian Federation has made frequent references to witness testimony in the text and the footnotes. In order to prove each of the twenty-eight illegalities the Russian Federation offers to hear the respective witnesses. In particular, the Russian Federation wishes to hear:
- (a) Mr. Anilionis, Mr. Zakharov and Mr. Gololobov and potentially other witnesses to prove the factual allegations in section III.B(a) relating to the use of fraud, bribery and collusion to acquire HVY's Yukos shares;
 - (b) Mr. Rybin and other investors to prove the factual allegations in section III.B(a) on corporate abuse, violence and attempted murder;
 - (c) Mr. Anilionis, Mr. Zakharov and others to prove factual allegation on setting up the structures aimed at tax evasion, *inter alia* to abuse the Russia-Cyprus DTA (see the factual allegations in section III.B(b));
 - (d) Mr. Anilionis, Mr. Zakharov and Mr. Gololobov to prove factual allegations concerning the tax evasion in (certain low-tax regions of) the Russian Federation in section III.B(c);
 - (e) Mr. Gololobov and others (e.g. those involved with the company Quadrum) to prove the factual allegations in section III.B(d) relating to the obstruction

of the tax authorities, destruction of evidence, as well as the facts relating to the money siphoned to and held by offshore companies; and

- (f) Mr. Golubovich, Mr. Anilionis, Mr. Zakharov and Mr. Gololobov and others involved to prove factual allegations in section III.C, including the fact that the Russian Oligarchs control various legal entities, including HVY and that they make and have made false statements in this regard.

1247. Chapter IV: the Russian Federation offers proof of its arguments in section IV.C of this Defence on Appeal by hearing witnesses including Mr. Golubovich, Mr. Anilionis, Mr. Zakharov, Mr. Gololobov and Mr. Achilleos, in particular in relation to the argument that the Russian Oligarchs had effective control of the trustees and therefore HVY.

1248. Chapter V: the Russian Federation in particular offers proof of its factual arguments regarding Mr. Valasek's actions as "assistant", more specifically the argument that he actually acted as a "fourth arbiter", by hearing witnesses (such as Mr. Valasek himself).

1249. Chapter VII: the Russian Federation refers to the aforementioned offer of proof regarding chapter III.

1250. Chapter VIII: by hearing witnesses the Russian Federation offers proof of its argument that Yukos Oil's share register was inaccessible for a long period of time and that the Russian Federation made no disingenuous allegations in relation thereto (reference is made in particular to section VIII.A(e)).

B. Conclusion

That it may please this Court of Appeal by judgment, in so far as legally possible enforceable regardless of any appeal:

- (a) to reject HVY's claims (also) in appeal, or to reject its grounds for appeal as unfounded, and confirm the judgment of 20 April 2016 of the District Court The Hague with case numbers/ cause-list numbers C/09/477160 / HA ZA 15-1 (case I), (C/09/477162 / HA ZA 15-2 (case II), (C/09/481619 / HA ZA 15-112 (case III), if necessary with improvement or supplementation of grounds;

UNOFFICIAL TRANSLATION

This text is an unofficial translation of the Dutch original. In case of any discrepancies, the Dutch original shall prevail.

- (b) to order HVY to pay the costs of both instances, to be increased by the statutory interest from the date of the judgment until the day of full payment, and the usual subsequent costs.

This case is handled by prof. *mr.* A.J. van den Berg, Hanotiau & van den Berg, 480 Avenue Louise, IT Tower (9th floor), 1050 Brussels, Belgium, *tel.* 0032 2290 3913, *fax.* 0032 22903942, e-mail ajvandenbergh@hvdb.com.

X. ANNEX 1 - QUOTES FROM EVIDENCE ALREADY SUBMITTED IN THE ARBITRATIONS CONCERNING YUKOS' SHAM COMPANIES IN LOW-TAX REGIONS, INCLUDING MORDOVIA²¹¹⁵

1251. Mr M.N. Silayev, formal founder and for three days director of Fargoil (Mordovia)²¹¹⁶ and mechanic by education, met someone named Vadim, who was engaged in the incorporation of companies. In order to earn some money, Silayev met up with Vadim a few times near a metro station outside Moscow. On the back seat of Vadim's car, Silayev signed documents in exchange for a loan of USD 200. Silayev had never heard of the company Fargoil. Fargoil made a profit of over USD 4 billion in 2001-2003.²¹¹⁷ See about Fargoil also §§ 1257 and 1270 below.

"In 2001, I met an employee from an organisation carrying out the business of registering enterprises and firms, I cannot tell the name of the organisations or full details of the person as it was only a passing acquaintance.

The only thing I can say is that I communicated with Vadim who proposed to me to earn some money by participating in registration of firms and organisations.

In the end of 2000/start of 2001, Vadim called me and proposed to meet and discuss certain matters relating to my participation in registration of a certain enterprise, we met near Domodedovskaya metro station, meeting was carried on in Vadim's car (...).

During the conversation he proposed that I provided him with a photocopy of the passport that I prepared earlier at his request for registration of an organisation, I cannot recall which exactly (because it was long ago).

As long as the payment terms proposed by Vadim for my services were then acceptable to me, I agreed to participate in registration of an organisation.

During the next meeting, which took place in a similar way, Vadim proposed me to sign several documents relating to registration of an enterprise; after sneak-peaking through documents I understood that those documents were necessary for registration of a certain organisation. I did not go through the documents proposed for signature more thoroughly as I am a mechanical

²¹¹⁵ See also Defence on Appeal, Reasons Ground 2: The Tribunal has did not provided any substantiation tenable reason for its incorrect opinion that the case file does not contain any evidence which demonstrates that the Mordovian companies of Yukos were trading shellsham companies.

²¹¹⁶ See for example tax report for 2001 as submitted during the Arbitrations, p. 86 (RME-345): "*Mikhail Nikolaevich Silaev – General Director from the moment of establishment [May 24, 2001] till May 27, 2001.*"

²¹¹⁷ Tax report for 2001, p. 92 (RME-345); tax report for 2002, p. 130 (RME-346); tax report for 2003, p. 101 (RME-206), as submitted during the Arbitrations.

UNOFFICIAL TRANSLATION

This text is an unofficial translation of the Dutch original. In case of any discrepancies, the Dutch original shall prevail.

engineer by education. I signed the documents. Then Vadim lent me money in the amount of 200 US dollars, so I drew up a bill of debt.

In the course of the year 2001, I met Vadim from time to time, about 7 meetings in total, I always met Vadim in his car, I received no cash from Vadim other than stated above, with the exception of a cash transfer of 11 000 roubles (...)

Question: What do you know about the enterprise called OOO Fargoil?

Answer: I cannot tell anything specific about this enterprise; perhaps, this organisation was registered by Vadim with the use of my passport.

I did not take part in registration personally; except signing the documents relating to registration of some enterprise, during the meetings with Vadim.

I did not sign personally any contracts with representatives of state or for-profit organisations, whether lease contracts or agreements for opening accounts with commercial banks and other documents necessary for registration of the organisation.

I did not go personally to Saransk (Republic of Mordovië) but I signed, pursuant to Vadim's request, several blank forms, which could be used by Vadim later for executing Powers of Attorney on my behalf, or other legal and financial documents. I do not know who became later the founder and the chief executive of the enterprise registered with the use of my passport.

(...) Question: You are showed copies of the following documents signed by Mikhail Nikolayevich Silayev and containing your passport details: Resolution No. 1 of the founder of Fargoil Limited Liability Company to create OOO Fargoil dated 21 May 2001; OOO Fargoil's Resolution No. 2 dated 28 May 2001 to remove OOO Fargoil's Director General, Mikhail Nikolayevich Silayev, and appoint Antonio Valdes-Garcia; Application to the Administration of Saransk for registration of OOO Fargoil; Power of Attorney to Dmitriy Aleksandrovich Zhuravlyov dated 23 May 2001 for representation in the City of Saransk; Articles of Association of OOO Fargoil; Sale and Purchase Agreement in respect of a participation interest in OOO Fargoil dated 25 May 2001. Is the signature in these documents yours?

Answer: No, it is not mine. Here is a copy of my passport containing a specimen signature."²¹¹⁸

1252. Mr Y.Y. Yegerov, formal director of Macro Trade (Mordovia), gave his passport to Reva to register an enterprise in exchange for some additional income (see about Reva also § xx below). Reva had Yegerov sign various documents. Yegerov did not know that he was CEO of Macro Trade and he also did not know anything about Macro Trade's activities.

²¹¹⁸ Transcript of the interrogation of Silayev (Exhibit RF 03.2.C-2.255 and RME-255), as submitted in the Arbitrations.

Macro Trade made profit of over USD 75 million in 2003.²¹¹⁹ See about Macro Trade also § 1256 below.

"Question: "When did you serve as the chief executive officer of OOO Makro-Trade? Did you sign a contract to work as the CEO?"

Answer: "In 2001, I gave my passport to Vitaly Vladimirovich Reva ('V. V. Reva') for registration of a firm, with the aim to receive additional income. I did not know that I was the head of OOO Makro-Trade and never occupied a managerial position."

(...) Question: "What did your direction over OOO Makro-Trade consist in?"

Answer: "During the period from autumn 2001 through the end of 2002 Mr. V.V. Reva several times (approximately 5 times) brought a set of documents to me for signature; I did not look into the contents of the documents; I signed where I was asked to sign."

Question: "How was the bank card carrying a specimen of your signature executed?"

Answer: "I did not personally execute any bank card, but I did sign some documents with V. V. Reva at a notary's, and those could have included a power of attorney. The notarial office is situated in the area of Polyanka Metro, but I do not remember its precise address."

(...)

Question: "Who was it that directly invited you to take up the position of the general director at OOO Makro-Trade?"

Answer: "I did not know that I was listed as the chief executive officer of OOO Makro-Trade. I received all of the documents I signed from V. V. Reva who has his registered domicile at Kubinka-10, Odintsovo District."

(...)

Question: "What can you say about the actual financial and business operations of OOO Makro-Trade?"

Answer: " I do not know what activities OOO Makro-Trade was involved in and I have nothing to do with the business activities of this company."

Question: "What can you say about the composition of founders at OOO Makro-Trade?"

²¹¹⁹ Tax report for 2003, p. 126 (RME-206), as submitted during the Arbitrations.

UNOFFICIAL TRANSLATION

This text is an unofficial translation of the Dutch original. In case of any discrepancies, the Dutch original shall prevail.

Answer: "I do not know the founders of OOO Makro-Trade. I only maintained contact with V. V. Reva."

Question: "What can you say about relations between OOO Makro-Trade and OAO NK YUKOS."

Answer: "I have nothing to tell you about relations between OOO Makro-Trade and OAO NK YUKOS."

Question: "Where, when, on whose initiative, and with which companies did OOO Makro-Trade sign its contracts?"

Answer: "I am not aware of OOO Makro-Trade's entering into contracts, their performance and payments under the contracts. I do not know what documents I signed, but contracts may have been among them".

Question: "Where and who executed and signed the financial statements and tax returns of OOO Makro-Trade?"

Answer: "I do not know who signed and prepared accounting and tax statements. I do not know what documents I signed, but financial documents may have been among them."

Question: "Where, who, and on whose initiative were OOO Makro-Trade's investment contracts were executed and which benefits did it enjoy?"

Answer: " I know nothing about entering into investment agreements and tax incentives for OOO Makro-Trade." ²¹²⁰

1253. Ms Y.V. Gavrilina, formal director of Yu-Mordovia (Mordovia), received fully prepared tax declarations from Moscow by mail, which she filed with the local tax authorities on the same day. She was unaware of the extent of the business activities of Yu-Mordovia. Yu-Mordovia made a profit of over USD 1 billion in 2000-2003.²¹²¹ See about Yu-Mordovia also §§ 1258-1259 and 1263 below.

"Between March 1, 2001 and June 26, 2003, I held the position of executive director at OOO Yu-Mordovia. I have merely a vague idea about the company's financial and business operations. My duties only included filing with the tax authorities of the tax declarations I received from Moscow by mail. I would do so on the same day the intended submissions arrived from

²¹²⁰ Transcript of the interrogation of Egorov as included in Russian tax authorities' response to Yukos' appeal in cassation, p. 13-14 (**Exhibit RF-03.2.C-2.257** and RME-257), as submitted in the Arbitrations.

²¹²¹ Tax report for 200, p. 54 (Annex (Merits) C-103); tax report for 2001, p. 69 (RME-345); tax report for 2002, p. 96 (RME-346); tax report for 2003, p. 60 (RME-206), as submitted during the Arbitrations.

UNOFFICIAL TRANSLATION

This text is an unofficial translation of the Dutch original. In case of any discrepancies, the Dutch original shall prevail.

Moscow. (...) The financial statements and tax declarations were executed in Moscow, but I have no knowledge about the signatories."²¹²²

1254. Ms T.G. Subbotina, from October 2000 until April 2001 formal director of Mars XXII (Mordovia), stated that the Mars XXII company seal was held in the safe at Yukos' administrative department in Moscow and that Mars XXII was in fact entirely controlled by Yukos. Mars XXII (later: Energotrade) made a profit of over USD 1 billion profit in 2003.²¹²³ See about Mars XXII also § 1255 below.

"1. From October 2000 to April 2001, I was the director of OOO Mars XXII. I was employed with a record in the labor book.

2. Education - technical college.

3. I was formally in charge of the management and a signatory on the documents.

4. The card was executed in accordance with the banking requirements.

5. There was no separate office; the seal was kept in the vault of Yukos' centralized accounting department.

6. During the period from January 1, 2000 to December 31 2003 I was neither the director nor a founder of any other entities.

7. Irina Golub (I cannot recall any other details) offered to take a position of the director at OOO Mars XXII as I was searching for job at the time.

8. I have no connection to OAO NK Yukos. I am not a shareholder of OAO NK Yukos. I have not been and am not currently employed by OAO NK Yukos.

9. As I was the only permanent employee of OOO Mars XXII, OAO NK Yukos was effectively carrying out the financial and business operations.

10. I have no knowledge of the founders of OOO Mars XXII.

²¹²² Transcript of the interrogation of Gavrilina as included in Russian tax authorities' response to Yukos' appeal in cassation, p. 16 (**Exhibit RF-03.2.C-2.257** and RME-257), as submitted in the Arbitrations. See also the tax report for 2001 (**Exhibit RF-03.2.C-2.345** and RME-345), as submitted in the Arbitrations, p. 10: "*Mrs. Gavrilina E. V., Executive Director of Limited Liability Company (OOO) Yu-Mordovia from March 1, 2001 through June 20, 2003, was interviewed as to the activities of OOO Yu-Mordoviya (Transcript of Interrogation of June 15, 2004 (without number)); she represented that she was hired by Mrs. Zhuravlova Marina Konstantinovna (Manager of OAO NK YUKOS) who also occupied position of the General Director of OOO Yu-Mordovia at that time. Mrs. Gavrilina was not aware where the goods being sold were located and the transportation procedure thereof; the required accounting and tax reports were received from Moscow in the ready-to file form.*"

²¹²³ Tax report for 2003, p. 116 (RME-206), as submitted during the Arbitrations.

UNOFFICIAL TRANSLATION

This text is an unofficial translation of the Dutch original. In case of any discrepancies, the Dutch original shall prevail.

11. OOO Mars XXII was effectively managed by OAO NK Yukos.
12. The contract documentation was prepared by the management of OAO NK Yukos; the payments under the contracts were processed through the centralized accounting department of OAO NK Yukos; I cannot recall the counterparties in the contracts.
13. The financial statements and tax reports were prepared by the centralized accounting department of OAO NK Yukos in the office. I signed the reports as needed.
14. I have no knowledge of whether any investment agreements were entered into and upon whose initiative; there were tax incentive[s] as the company was based in an offshore zone."²¹²⁴

1255. Ms A.V. Tsigura, formal director of Mars XXII (Mordovia) did not know how long she had been director of Mars XXII and whether she had concluded contracts in that capacity. She also did not know whether there were oil products and where they would be stored. See about Mars XXII also § 1254 above.

"[illegible] can't state with certainty that I was involved in the registration of the company.

Question: How did the entity pursue its business, specifically, what was the contract [illegible] and customer identification procedure in 2000?

Answer: I do not remember whether the company operated in 2000, and whether I entered into contracts as the General Director.

Question: On what administrative territory and who issued source accounting documents, specifically, contracts, agreements, delivery and acceptance reports, waybills, invoices, etc. in 2000?

Answer: I don't remember who kept the company's accounting records, where were the source accounting documents located and who issued them.

Question: Where, at which entities, were the oil and oil products stored that were sold to the customers?

²¹²⁴ Transcript of the interrogation of Subbotina (**Exhibit RF -03.2.C-2.258** and RME-258), as submitted in the Arbitrations. See also the tax report for 2001 (**Exhibit RF-03.2.C-2.345** and RME-345), as submitted in the Arbitrations, p. 10: "*Subbotina Tatyana Grigoryevna, Head of Limited Liability Company OOO Mars XXII INN (taxpayer's identification number) 1326178129 from October 2000 through April 2001 (Transcript of Interrogation No. 43/la of May 18, 2004), explained that since she was the sole (member of the OOO Mars XXII staff, the financial and business activities were actually carried out by OAO NK YUKOS, that actually managed OOO Mars XXII. OAO NK YUKOS management processed the contracts, the settlements under the contracts were performed through the centralized accounting department of OAO NK YUKOS. The accounting department of OAO NK YUKOS compiled accounting and tax reports in the office.*"

UNOFFICIAL TRANSLATION

This text is an unofficial translation of the Dutch original. In case of any discrepancies, the Dutch original shall prevail.

Answer: I cannot answer with certainty whether there were oil products; if they existed, I do not remember where they were stored.

Question: How long did you serve as the general director of OOO Mars XXII for, and who took the decision to dismiss you?

Answer: I do not remember how long I was the General Director and who took the decision to dismiss me."²¹²⁵

1256. Ms G.K. Zhukova, formal founder and director of Mega-Alliance (Baikonur) and Macro Trade (Mordovia), had never heard of Macro Trade. See about Macro Trade also § 1252 above. She had never been to the Republic of Mordovia either. She declared that her passport had been stolen and that later someone had dropped it into the mail-box at the place where she lived.

"I have never heard of the existence of OOO Makro-Trade (INN 1326183030), I did not establish it. I have never been to the Republic of Mordovië. My answer to your questions would be as follows. In the beginning of December 1998 and early in 1999, I was an engineer concerned with overseeing job completion and licensing at enterprises owned by TOO Agrotekh in the village of Obukhovo, Noginsk District – a position which sent me travelling all the time not only in, but also beyond, the Moscow Region. It was then that my purse, which contained, among other things, Passport XXVIII-IK No. 744845 issued by the police department in Elektrostal on March 5, 1991, was stolen. I did not go to the police to report the theft, because my passport was returned to me at the end of January 1999, when someone dropped it into the mail-box at the place where I lived. I can also declare that I have not given my passport to anyone – either for a fee or free of charge, as I am fully aware of the resulting liability and of the possible problems which can ensue."²¹²⁶

1257. Mr M.A. Sutyaginsky, employee of a trading partner, declared that people of Yukos negotiated contracts between his company, Alta Trade (Mordovia) and Fargoil (Mordovia). See about Fargoil also §§ 1251 and 1270 and about Alta Trade §§ 1258 and 1260.

²¹²⁵ Transcript of the interrogation of Tsigura (**Exhibit RF -03.2.C-2.256** and RME-256), as submitted in the Arbitrations.

²¹²⁶ Transcript of the interrogation of Zhukova as included in Russian tax authorities' response to Yukos' appeal in cassation, p. 15-16 (**Exhibit RF-03.2.C-2.257** and RME-257), as submitted in the Arbitrations. See also the tax report for 2001 (**Exhibit RF-03.2.C-2.345** and RME-345), as submitted in the Arbitrations, p. 10: "*Zhukova Gulnoura Karimovna was interviewed as to the establishment of Limited Liability Company (OOO) Mega-Alyans INN (taxpayer's identification number) 9901004712 and financial and business activities thereof (Letter of Explanation of April 30, 2004) (Mrs. Zhukova explained that she was not aware of the existence of OOO Mega-Alyans, and she did not know Polupinsky Kirill Viktorovich, Kartashov Vladislav Nikolaevich, Reshetnikov Nikolai Arkadyevich, who are the managers of OOO Mega-Alyans according to the foundation documents. She also advised that she lost her passport in November 1998).*"

UNOFFICIAL TRANSLATION

This text is an unofficial translation of the Dutch original. In case of any discrepancies, the Dutch original shall prevail.

"As far as relations with OAO NK YUKOS are concerned, the explanation is that even before OOO ZSK Titan was established, M. A. Susetinsky, V. D. Krynin, and myself had been jointly looking for suppliers of raw petrochemical and made contact with OAO NK YUKOS in Moscow. That firm has a department for hydrocarbon sales and it is through them that Titan got in touch with OOO Alta-Trade and OOO Fargoil. The two were suppliers of the commodities Titan needed, but I still held all negotiations on their deliveries from OOO Alta-Trade and OOO Fargoil with representatives of OAO NK YUKOS, namely: with Vladimir Dmitriyevich Ostroverkhov. In the course of our work with OOO Alta-Trade and OOO Fargoil, there never arose any serious grievance regarding performance under the corresponding contracts. There were no written contracts executed between OAO NK YUKOS and OOO ZSK Titan."²¹²⁷

1258. Ms Y.V. Klimantovich was formal director of A-Trust (Moscow). A-Trust was the co-founder of Alta Trade (Mordovia) and co-founder and co-shareholder of Yu-Mordovia (Mordovia).²¹²⁸ See about Yu-Mordovia also §§ 1253, 1259 and 1263. Klimantovich declared that A-Trust had not founded Yu-Mordovia.

"I have been the general director at OOO A-Trust from the spring of 2000. The company enters into transactions with securities and maintains no business in the Mordovië Republic. OOO ATrust has not founded OOO Yu-Mordovia, and I am unable to provide any information about either the latter's alleged establishment by OOO A-Trust or about the purposes for which OOO Yu-Mordovia has been established."²¹²⁹

1259. Ms T.M. Kolupayeva was the alleged director of Sonata (Moscow). Sonata was the co-founder of Ratmir (Mordovia) and co-founder and co-shareholder of Yu-Mordovia (Mordovia).²¹³⁰ See about Mordovia also §§ 1253, 1258 and 1263. Kolupayeva declared that Sonata did not operate in Mordovia and that Sonata had not incorporated Yu-Mordovia.

²¹²⁷ Transcript of the interrogation of Sutyaginsky as included in Russian tax authorities' response to Yukos' appeal in cassation, p. 1511 (Exhibit RF-03.2.C-2.257 and RME-257), as submitted in the Arbitrations. See also the tax report for 2001 (Exhibit RF-03.2.C-2.345 and RME-345), as submitted in the Arbitrations, p. 11: "*Mr. Sutyaginsky Michail Alexandrovich, General Director of Limited Liability Company (OOO) ZSK Titan was interviewed as to the incorporation of OOO ZSK Titan INN (taxpayer's identification number) 550 1052263 and financial and business activities thereof (Transcript of IntelTogation of May II, 2004; he represented that he negotiated supplies of oil resources from OOO Fargoil to OOO Alta Trade with representatives of OAO NK YUKOS.*"

²¹²⁸ Tax Report for 2001, p. 43 and 59 (Exhibit RF-03.2.C-2.345 and RME-345), as submitted in the Arbitrations.

²¹²⁹ Transcript of the interrogation of Klimantovich as included in Russian tax authorities' response to Yukos' appeal in cassation, p. 16 (Exhibit RF-03.2.C-2.257 and RME-257), as submitted in the Arbitrations.

²¹³⁰ Tax Report for 2001, p. 51 and 58 (Exhibit RF-03.2.C-2.345 and RME-345), as submitted in the Arbitrations.

UNOFFICIAL TRANSLATION

This text is an unofficial translation of the Dutch original. In case of any discrepancies, the Dutch original shall prevail.

"According to the explanations obtained from Tatyana Mikhailovna Kolupayeva (case file vol. 288, pp. 33-34), she had served as the general director of OOO Sonata since September 3, 1996. She said that her limited liability company's business was engaging in transactions with securities and that it did not operate in the Mordovia Republic. OOO Sonata had not been the founder of OOO Yu-Mordovia, and she had no information about either the latter's establishment by her company or about the purposes for which OOO Yu-Mordovia had been established."²¹³¹

1260. Mr S.G. Litovchenko, employee of a trading partner, declared that he did not know Alta Trade (Mordovia), whereas his company had sold 683 tonnes of oil in the amount of EUR 3 million tonnes to Alta Trade on paper. Alta Trade made a profit of over USD 250 million in 2000-2003.²¹³² See about Alta Trade also §§ 1257-1258.

"Litovchenko Sergei Georgievich, Deputy General Director of Limited Liability Company (OOO) East Bridge Naphtha INN (taxpayer's identification number) 7743004512 (Letter of Explanation of May 7, 2004, and of May II, 2004), represented that he did not know the firm OOO Alta-Trade (thereat: OOO East Bridge Naphtha sold 683 tons of petroleum products worth RUR 3,130 thou. (excluding VAT) to OOO Alta-Trade under Contract No. 014/0 I-IBN of May 5, 2001)."²¹³³

1261. Mr Y.A. Lyashev, formal director of Yukos-M (Mordovia), declared that he did not know anything about relationships between Yukos-M and Yukos. Yukos-M made a profit of over USD 2 billion in 2000-2003.²¹³⁴

"I can tell you nothing about relations between ZAO YUKOS-M and OAO NK YUKOS, because I have never been concerned with the financial or economic operations of the former company or signed any of its contracts or other documents with its business partners"²¹³⁵

1262. Ms I.A. Sidirova, formal founder and director of Nefteservice (Mordovia), declared that she did not know that she was the chief executive officer of Nefteservice. She signed

²¹³¹ Description of the statement by Kolupayeva, as included in Russian tax authorities' response to Yukos' appeal in cassation, p. 16 (**Exhibit RF-03.2.C-2.257** and RME-257), as submitted in the Arbitrations.

²¹³² Tax report for 2000, p. 36 (Annex (Merits) C-103); tax report for 2001, p. 49 (RME-345); tax report for 2002, p. 106 (RME-346); tax report for 2003, p. 60 (RME-206), as submitted during the Arbitrations.

²¹³³ Tax Report for 2001, p. 10 (**Exhibit RF-03.2.C-2.345** and RME-345), as submitted in the Arbitrations.

²¹³⁴ Tax report for 2000, p. 45 (Annex (Merits) C-103); tax report for 2001, p. 55 (RME-345); tax report for 2002, p. 102 (RME-346); tax report for 2003, p. 66 (RME-206), as submitted during the Arbitrations.

²¹³⁵ Transcript of the interrogation of Lyashev as included in Russian tax authorities' response to Yukos' appeal in cassation, p. 16 (**Exhibit RF-03.2.C-2.257** and RME-257), as submitted in the Arbitrations.

UNOFFICIAL TRANSLATION

This text is an unofficial translation of the Dutch original. In case of any discrepancies, the Dutch original shall prevail.

documents only if someone named Nalivaiko asked her to, without knowing who had prepared those documents.

"Question: "Irina Alexandrovna Sidorova, when did you serve as the chief executive officer of OOO Nefteservice? Was any contract or use agreement executed for you to serve in that capacity?"

Answer: "I did not work as the CEO and am unaware if any use agreement was made."

Question: "What is your level of education?"

Answer: "I have higher education and have graduated from Moscow's State Teachers Institute named after Lenin."

Question: "What was your service in charge of OOO Nefteservice all about? Did it consist in the full-scale performance of the CEO's functions or was it merely limited to document signing?"

Answer: "I just signed the documents."

Question: "How was the bank card carrying you signature executed?"

Answer: "I am not aware of that."

Question: "Where was the company's seal kept and by whom?"

Answer: "I have no idea."

Question: "Irina Alexandrovna Sidorova, at which other companies were you listed as the chief executive officer and founder between January 1, 2000 and December 31, 2003?"

Answer: "I have no answer."

Question: "Who was it (please identify the person by the first name, middle name, and surname or provide their passport data or other personal information) that directly offered you the job of the general director at OOO Nefteservice and other companies."

Answer: "I did not consent to the service as general director. I have no idea how my appointment to that office proceeded."

Question: "How directly were you related to OAO NK YUKOS (INN [tax ID] 8604010486)? Were you ever or are you now its shareholder? Did you ever work at or are you currently employed by OAO NK YUKOS?"

Answer: "Leonid Nalivaiko offered me some shares to be purchased. For that purpose, he took my passport data and told me to sign some papers. I do not know the company whose shares were being bought."

UNOFFICIAL TRANSLATION

This text is an unofficial translation of the Dutch original. In case of any discrepancies, the Dutch original shall prevail.

Question: "Which explanations can you offer about the actual financial and business operations of OOO Nefteservice at the time you were in charge?"

Answer: "I don't know. None."

Question: "Which explanations can you give regarding the composition of founders at OOO Nefteservice?"

Answer: "I don't know. None."

Question: "What can you say about relations between OOO Nefteservice and OAO NK YUKOS (INN 8604010486) at the time you were in charge of the latter?"

Answer: "Nothing. I do not know anything."

Question: "Where, when, on whose initiative, and with which companies did OOO Nefteservice enter into contracts at the time of your management of the company and what can you say about the actual performance of those contracts and about the payments made under them?"

Answer: "I know nothing on that subject."

Question: "Who signed the company's financial statements and tax returns and where? How were those reporting documents signed?"

Answer: "I do not know who executed those documents or where. They were brought to me by Nalivaiko who asked me to sign them, explaining that it was necessary to do so."²¹³⁶

Question: "Who signed the company's financial statements and tax returns and where? How were those reporting documents signed?"

Answer: "I do not know who executed those documents or where. They were brought to me by Nalivaiko who asked me to sign them, explaining that it was necessary to do so."

1263. Ms V.M. Yezhova was formal director of the enterprise Stekloprommash (Moscow). Stekloprommash was co-founder and co-shareholder of Yu-Mordovia (Mordovia).²¹³⁷ See about Yu-Mordovia also §§ 1253 and 1258-1259 above. Yezhova declared that Stekloprommash had no relations with Yu-Mordovia while she worked there.

²¹³⁶ Transcript of the interrogation of Sidirova, as included in Russian tax authorities' response to Yukos' appeal in cassation, p. 14-15 (Exhibit RF-03.2.C-2.257 and RME-257), as submitted in the Arbitrations.

²¹³⁷ Tax Report for 2001, p. 59 (Exhibit RF-03.2.C-2.345 and RME-345), as submitted in the Arbitrations.

UNOFFICIAL TRANSLATION

This text is an unofficial translation of the Dutch original. In case of any discrepancies, the Dutch original shall prevail.

"I have been the general director of AOZT Stekloprommash from August 2001. My job responsibilities have included the management of that company's financial and economic operations, the submission of Financial statements to the tax authority, and the payment of taxes. The company is in sales and purchases of securities on the Russian market. During my involvement with AOZT Stekloprommash, it has had no relations with OOO Yu-Mordovia and OOO YUKOS-Import, and I do not know any officers from OOO Yu-Mordovia and OOO YUKOS-Import."²¹³⁸

1264. See §§ 1265-1269 below for comparable incomprehensible structures with dummy directors and founders in Lesnoy, Trekhgorny and other low tax regions.

1265. Mr S.A. Varketin, formal director of Investproekt (Lesnoy/Trekhgorny),²¹³⁹ was a street sweeper by trade. As CEO of Investproekt, Varketin was not authorized to sign documents for the enterprise and he did not know where the company seal was kept.

"I have been working at the Municipal Public Utility Enterprise No. 6 as a street sweeper since August 01, 1998. In May 2009, I was approached by Georgiy Gennadyevich Potapov (captain of police, criminal investigation department of the Leninskiy District Division of Home Affairs of the City of Kirov) with a proposal to go to the notary (7 Koneva str., building 5, room 1, Kirov) in order to execute the documents of OOO Invest-Proekt [sic] where I was appointed as the executive.

In May 2001, G.G. Potapov and I travelled to Chita Irkutsk in order to buy a car. In that same month of May G.G. Potapov purchased a Nissan in ~~Irkutsk~~ Chita and titled it in my name. Having purchased the car, G.G. Potapov took four (4) big bags with accounting documents of OOO Invest-Proekt out of the hotel where we stayed.

The hotel is also situated in Chita.

When we stopped for the night in a hotel in Irkutsk, we left the car in the street near the hotel and we didn't take the documents from the car. During the night, the car was stolen.

G.G. Potapov made a statement at a District Office of Home Affairs of Irkutsk in connection with a car theft. The car and the documents have not been found until now.

OOO Invest-Proekt is located in Leninskoye, Shabalinskiy District, Kirov Region. I am not aware of the existence of office enterpri [sic] premises at this address, as I never been there.

²¹³⁸ Transcript of the interrogation of Yezhova, as included in Russian tax authorities' response to Yukos' appeal in cassation, p. 16 (Exhibit RF-03.2.C-2.257 and RME-257), as submitted in the Arbitrations.

²¹³⁹ All enterprises from Lesnoy and Trekhgorny eventually merged into Investproekt, see Final Awards, marginal 389.

UNOFFICIAL TRANSLATION

This text is an unofficial translation of the Dutch original. In case of any discrepancies, the Dutch original shall prevail.

My functional duties as the executive of OOO Invest-Proekt include control over the course and the legality of operations of the enterprise.

I have never seen and I do not know the accountant of the enterprise.

In addition to the position of the executive of OOO Invest-Proekt, I am also the executive of OOO Perspektiva-Optimum (Chita), Alkhanay Trading Company.

In the trip to Chita and Irkutsk, G.G. Potapov and I were accompanied by Sergey who works at Škoda Driving School (21 Stroiteley str., Kirov).

After return from Irkutsk and Chita, Sergey brought me money at home (travel allowance) in the amount of 10,500 rubles.

OOO Invest-Proekt was sold to me by Lipatnikov, who lives in Moscow. All settlements with Lipatnikov were carried out by Sergey. The approximate price, for which Lipatnikov sold me OOO Invest-Proekt, was 40 thousand rubles; in the same way and for the same price, Lipatnikov sold me OOO Perspektiva-Optimum and OOO TK Alkhanay, the total price of the three enterprises is 120 thousand rubles.

I have never seen nor met Lipatnikov.

I have never seen the seal of the enterprise either, and where it is I don't know. Maybe, the seal and the documents of all the three enterprises are at the legal and street address of OOO Invest-Proekt in Leninskoye, Kirov Region.

As the executive of the enterprise, I have no right to sign; I didn't sign any documents reflecting financial and business activities of the enterprise or orders.

The seal of OOO Invest-Proekt is, probably, with Sergey who works at Škoda Driving School.

This is a true rendition of my words in two leaves, which I have read."²¹⁴⁰

1266. Mr V.V. Reva, formal director of Sibirskaya (Kalmukkië), came into contact with a person referred to as A.A. via a poster at a bus station. This A.A. person offered Reva a job as CEO. Reva did not carry out any management duties. For USD 100 each time, Reva signed several documents in cafes during A.A.'s lunch breaks. Reva was also offered money if he could find others to do similar work for A.A. Reva had no idea of the activities of the company of which he was the director on paper.

²¹⁴⁰ Transcript of the interrogation of Varketin (Exhibit RF -03.2.C-2.259 and RME-259), as submitted in the Arbitrations.

UNOFFICIAL TRANSLATION

This text is an unofficial translation of the Dutch original. In case of any discrepancies, the Dutch original shall prevail.

"Question: "When did you serve as the chief executive officer of OOO Vostochno-Sibirskaya Kompaniya? Did you sign a contract to work as the CEO?"

Answer: "At a trolleybus stop near the Paveletsky Railway Terminal in 2001, I noticed a sticker soliciting candidates for office work. I called the contact telephone number indicated there and went to the office located at 76 Sadovnicheskaya Street, Moscow. I do not remember the name of the firm though. At the office, I met with Alexander Andreyevich, who offered me the job of a company's chief executive officer, explaining that newcomers to Moscow were in need of off-the-shelf firms complete with nominal CEOs always at hand. By agreement with him, I was to come to Moscow each time Alexander Andreyevich ('A. A.') would call me in by phone in order to sign the papers already prepared. We would usually meet at various cafes during his lunch breaks. A. A. promised me 100 United States dollars for each such trip in return for such services, as well as further payment should I find others willing to earn some extra money [in that way]. I was aware that I was listed as the chief executive officer of OOO Vostochno-Sibirskaya Kompaniya, but I did not take any practical step as its CEO. I invited my acquaintances – A. V. Kazantsev, Y. Y. Yegorov, P. E. Tumm, A. K. Naplekov, and V. V. Khristin – to take up similar jobs."

Question: "What is your level of education?"

Answer: "I have a higher education after graduating from the Government Administration Institute in Moscow in 2004."

Question: "What did your direction over OOO Vostochno-Sibirskaya Kompaniya consist of and come to?"

Answer: "From the fall of 2001 till the end of 2003, I repeatedly traveled to Moscow (about five or six times a year) to meet with A.A. and brought back a package of documents for my acquaintances to sign. I never tried to understand what the documents were about and just signed them where requested."

Question: "How was the bank card carrying a specimen of your signature executed?"

Answer: "I do not even know whether I executed any such bank card, because I have no knowledge of accounting documents, but I signed some documentation with A.A. at a notary's somewhere near the Polyanka metro station. I do not remember the exact address of the notarial office, but I will be able to show you the place if we go there."

Question: "Where was the seal of OOO Vostochno-Sibirskaya Kompaniya kept and by whom?"

Answer: "I have never seen the seal and have no idea where it may be."

UNOFFICIAL TRANSLATION

This text is an unofficial translation of the Dutch original. In case of any discrepancies, the Dutch original shall prevail.

Question: "What are the other companies where you were the chief executive officer and founder during the period from January 1, 2000 till December 31, 2003?"

Answer: "I have never been the chief executive officer and founder of any [other] company."

Question: "Who was it that directly invited you to take up the general directorship at OOO Vostochno-Sibirskaya Kompaniya?"

Answer: "I was aware that I was serving as the chief executive officer of OOO Vostochno-Sibirskaya Kompaniya. All of the documents I signed were given to me by A. A., but I do not know who was the actual manager of OOO Vostochno-Sibirskaya Kompaniya. I did not discuss the matter with anyone but A. A."

Question: "How are you directly related to OAO NK YUKOS?"

Answer: "I have no relation to OAO NK YUKOS. I have never been its shareholder and employee."

Question: "What can you say about the actual financial and business operations of OOO Vostochno-Sibirskaya Kompaniya?"

Answer: "I have no idea about the business of OOO Vostochno-Sibirskaya Kompaniya, as I have never had anything to do with its financial and business operations."

Question: "What can you say about the founders of OOO Vostochno-Sibirskaya Kompaniya?"

Answer: "I am not aware who has founded OOO Vostochno-Sibirskaya Kompaniya, as I only maintained contact with A. A."

Question: "What can you say about relations between OOO Vostochno-Sibirskaya Kompaniya and OAO NK YUKOS?"

Answer: "I can tell you nothing about relations between OOO Vostochno-Sibirskaya Kompaniya and OAO NK YUKOS."

Question: "Where, when, on whose initiative, and with which companies did OOO Vostochno-Sibirskaya Kompaniya sign its contracts?"

Answer: "I have no idea about the execution and performance of, as well as payments made under, the contracts of OOO Vostochno-Sibirskaya Kompaniya. Nor am I aware of which exactly documents I signed, but they could well have included contracts."

Question: "Where and who executed and signed the financial statements and tax returns of OOO Vostochno-Sibirskaya Kompaniya?"

Answer:" I do not know either where the financial statements and tax returns of OOO Vostochno-Sibirskaya Kompaniya were executed or who signed them. I do not really know what the documents I signed were exactly about, but there could well have been financial documents among them. A. A. told me that the company established using my personal documents had an accountant on its staff who would take care of all bookkeeping. I have never personally seen that individual and know nothing about him or her."²¹⁴¹

1267. Mr M.V. Yelfimov allegedly signed contracts with Evoil (Evenkia) in several cities in a single day, while the cities are over 2,000 km apart.

"based on the results of the auction held on 18 November 2002, M.V. Yelfimov executed three contracts on the same day (19 November 2002), to sell oil to Evoil OOO at the price of RUB 1,625: contract No. 125-n with Yuganskneftegas OAO [...] contract No. 126-n with Tomskneft Eastern Oil Company OAO [...] and contract No. 127-n with Samaraneftegas OAO [...]. The above agreements were allegedly executed by M.V. Yelfimov in three different towns on the same day of 19 November 2002: in Nefteyugansk (Khanty-Mansi Autonomous Region), Strezhevoy (Tomsk region), and Samara (Samara region)."²¹⁴²

1268. Ms T.A. Volok, formal founder of Sibirskaya (Kalmukkië), declared that she had never founded that company and never served as its chief executive officer.

"Tatyana Alexandrovna Volok, appearing in documents as the founder of OOO Vostochno-Sibirskaya Servisnaya Kompaniya, testified (case file vol. 228, pp. 82-84) that she had [never] founded that company and never served as its chief executive officer and that she had only learned about its existence when asked to give related explanations. She had never lost her passport, but her husband, Dmitry Borisovich Volok, she had not heard from since November 27, 1999 was holding a photocopy of her old-format passport. By a court judgment, Dmitry Borisovich Volok had been pronounced disappeared."²¹⁴³

²¹⁴¹ Transcript of the interrogation of Reva as included in Russian tax authorities' response to Yukos' appeal in cassation, p. 11-13 (**Exhibit RF-03.2.C-2.257** and RME-257), as submitted in the Arbitrations.

²¹⁴² Judgment of the Federal Arbitrazh Court in Moscow dated 30 June 2005, p. 23-24 (Annex (Merits) C-184), as submitted in the Arbitrations.

²¹⁴³ Description of the statement by Volok, as included in Russian tax authorities' response to Yukos' appeal in cassation, p. 16 (**Exhibit RF-03.2.C-2.257** and RME-257), as submitted in the Arbitrations. See also the tax report for 2001 (**Exhibit RF-03.2.C-2.345** and RME-345), as submitted in the Arbitrations, p. 10: "*Volok Tatyana Alexandrovna was interviewed as to the establishment of Limited Liability Company East-Siberian Service Company, INN (taxpayer's identification number) 1326183023, and its financial and business activities (Transcript of Interrogation of April 23, 2004, Letter of Explanation of April 23, 2004). Mrs. Volok represented that she did not incorporate OOO East-Siberian Service Company and learned about the existence of this company only on the day of the interview, i.e. on April 23, 2004. She also advised that Mr. Volok Dmitry Borisovich had copies of her old passport, and she did not have any contacts with him since November 27, 1999 (Mr. Volok is on the wanted list).*"

UNOFFICIAL TRANSLATION

This text is an unofficial translation of the Dutch original. In case of any discrepancies, the Dutch original shall prevail.

1269. Ms S.I. Vorobyova was a formal director and shareholder of Ratibor (Evenkia). The passport that was registered in her name was never issued and contained incorrect information.

"According to Letter No. 1/86 sent by the Internal Affairs Department for Smolensk Region on April 30,2004, the passport in the name of Vorobyova Svetlana Ivanovna (Head of OOO Ratibor INN (taxpayer's identification number) 881007605, and the sole owner of OOO Ratibor until May 18, 2001) with the series and number indicated in the foundation documents of Limited Liability Company (OOO) Ratibor was never issued, the city of Vyazma is not divided into districts, there is no Chkalovsk District in Smolensk Region."²¹⁴⁴

1270. Yukos fabricated a complicated group structure with different layers of offshore companies and trusts to conceal the fact that the sham companies belonged to the Yukos group of companies. In the Arbitrations, by way of example, the group structure was visualised in which the sham companies Fargoil (Mordovia) and Ratibor (Evenkia) had been included in 2003.²¹⁴⁵ See about Fargoil also §§ 1251 and 1257 above.

²¹⁴⁴ Tax report for 2001, p. 11 (**Exhibit RF-03.2.C-2.345** and RME-345), and the Russian tax authorities' response to Yukos' appeal in cassation, p. 11 (**Exhibit RF-03.2.C-2.257** and RME-257), as submitted in the Arbitrations.

²¹⁴⁵ Chart 3 - 'Yukos offshore structure (2003)' as included in Respondent's Rejoinder, § 593 (**Exhibit RF-03.1.B-5**). See also Respondent's Counter-Memorial, § 275 and chart 8 (**Exhibit RF-03.1.B-3**).

This text is an unofficial translation of the Dutch original. In case of any discrepancies, the Dutch original shall prevail.

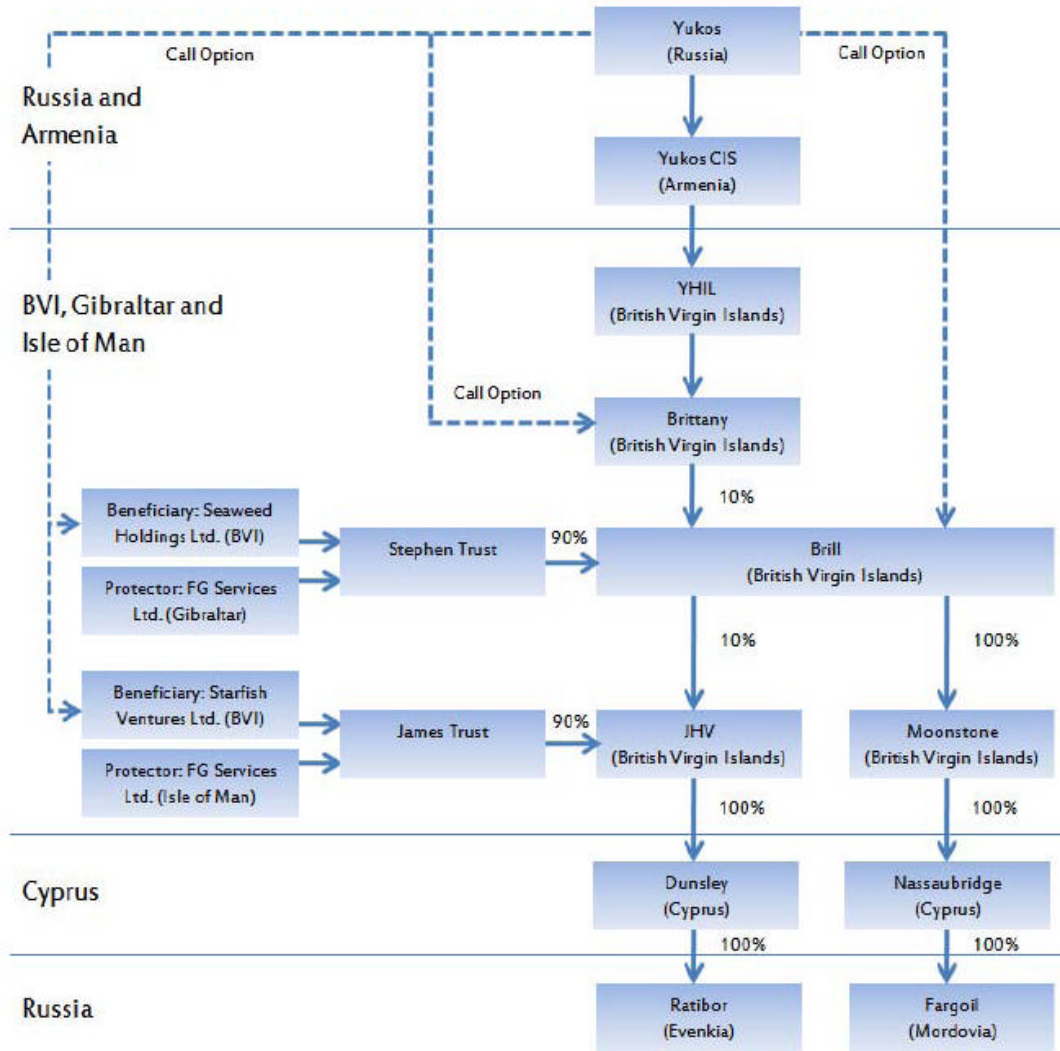

XI. LIST OF DEFINED TERMS

TERM (EN)	TERM (NL)	DEFINITION (EN / NL)
1991 Fundamentals	Grondbeginselen van 1991 (of Grondbeginselen van de RFW Buitenlandse Investerings)	Fundamentals of Legislation on Foreign Investments in the USSR, 1991, later implemented in the 1991 Law on Foreign Investment <hr/> Grondbeginselen van wetgeving over buitenlandse investeringen in de USSR, 1991, later opgegaan in de 1991 RFW Buitenlandse Investerings
1994 Joint EC Statement (as defined in the Writ); 1994 Commission Communication	Gezamenlijke Verklaring van de EG van 1994 (als gedefinieerd in de Dagvaarding); Gezamenlijke EG Verklaring van 1994	Joint statement on Article 45 ECT by the Council and the Commission of the European Communities and the then twelve EC Member States, December 1994 <hr/> Gezamenlijke verklaring over artikel 45 ECT door de Raad en Commissie van de Europese Gemeenschappen en de toen twaalf EG lidstaten, december 1994
1998 Council Decision	Besluit Europese Raad 1998	Decision of the Council on an amendment to the trade-related provisions of the ECT in 1998 <hr/> De beslissing uit 1998 van de Europese Raad over een amendement op handelsgerelateerde bepalingen van de ECT
A Loan	A Loan	USD 1 billion loan entered into on 24 September 2003 by Yukos from the Western Banks and secured by certain of Yukos' oil export contracts and by YNG <hr/> USD 1 miljard lening verstrekt aan Yukos op 24 september 2003 door de Westerse banken met zekerheden op bepaalde olie-exportcontracten van Yukos en zekerheden verstrekt door YNG
Annex (Merits) C-	Annex (Merits) C-	Exhibits submitted by Claimants with their Memorial on the Merits dated September 15, 2010 and Reply on the Merits dated March 15, 2012 <hr/> Producties ingediend door Eiseressen bij hun Memorial on the Merits van 15 september 2010 en Reply on the Merits van 15 maart 2012
Arbitrations	Arbitrages	Three parallel international investment treaty arbitrations initiated by Claimants against the Russian Federation <hr/> Drie parallelle internationale investeringsarbitrages die zijn ingesteld door Eiseressen tegen de Russische Federatie
Arbitrators	Arbiters	Fortier, Poncet (as of September 24, 2007, replacing Price who resigned as arbitrator on May 31, 2007) and Schwebel <hr/> Fortier, Poncet (vanaf 24 september 2007, als vervanger van Price die aftrad als arbiter op 31 mei 2007) en Schwebel
Arbitrazh	Russisch	Arbitrazh Procedure Code of the Russian Federation

UNOFFICIAL TRANSLATION

This text is an unofficial translation of the Dutch original. In case of any discrepancies, the Dutch original shall prevail.

Procedure Code	Wetboek van Rechtsvordering in Handelszaken	(2002) Russisch Wetboek van Rechtsvordering in Handelszaken (2002)
Asoskov Expert Opinion (or Expert Report)	Asoskov Opinion	Expert Report of Professor Anton V. Asoskov Deskundigenbericht van Professor Anton V. Asoskov
Avakiyan I Expert Opinion	Avakiyan Opinion I	S.A. Avakiyan Expert Opinion on the Constitutional Legal Aspects of the Conclusion and Application of International Treaties of the Russian Federation, February 21, 2006 S.A. Avakiyan deskundigenbericht over de juridische constitutionele aspecten van het sluiten en de toepassing van internationale verdragen van de Russische Federatie, 21 februari 2006
Avakiyan II Expert Opinion	Avakiyan Opinion II	Expert Comments by Professor C.A. Avakiyan regarding expert opinion of V. Gladyshev, June 29, 2006 Opmerkingen van deskundige, professor C.A. Avakiyan met betrekking tot het deskundigenbericht van V. Gladyshev, 29 juni 2006
Baglay Expert Opinion	Baglay Opinion	M.V. Baglay Opinion on Provisional Application of International Treaties According to the Constitution of the Russian Federation, February 26, 2006 M.V. Baglay deskundigenbericht over voorlopige toepassing van internationale verdragen volgens de Grondwet van de Russische Federatie, 26 februari 2006
Baikonur	Baikonur	One of the low-tax regions in the Russian Federation Een van de lage belastingregio's in de Russische Federatie
Bank Menatep	Menatep Bank	A company owned by the Menatep Group Een vennootschap van de Menatep Group
BCB	BCB	British Carribean Bank De Britse Carribische Bank
BFG	BFG	OOO Baikalfinancegroup (or Baikal Finance), the entity which purchased YNG at an auction and which was bought by Rosneft Baikal Finance Group (of Baikalfinancegroup), de vennootschap die (aandelen in) YNG overnam op een veiling en door Rosneft werd overgenomen
BIT	BIT	Bilateral Investment Treaty Bilateraal Investeringsverdrag
Burlington	Burlington	<i>Burlington Resources Inc. v. Republic of Ecuador</i> , ICSID ARB/08/5, Decision on Jurisdiction, June 2, 2010 <i>Burlington Resources Inc. v. Republic of Ecuador</i> , ICSID ARB/08/5, arbitraal vonnis over jurisdictie, 2 juni 2010

UNOFFICIAL TRANSLATION

This text is an unofficial translation of the Dutch original. In case of any discrepancies, the Dutch original shall prevail.

C-	C-	Exhibits submitted by Claimants with their Notices of Arbitration and Statements of Claim dated February 3, 2005 (HEL and YUL) and February 15, 2005 (VPL), Counter-Memorials on Jurisdiction and Admissibility dated June 30, 2006, and Rejoinders on Jurisdiction and Admissibility dated June 1, 2007 <hr/> Producties ingediend door Eiseressen bij hun Notices of Arbitration en Statements of Claim van 3 februari 2005 (HEL en YUL) en 15 februari 2005 (VPL), Counter Memorials on Jurisdiction and Admissibility van 30 juni 2006 en Rejoinders on Jurisdiction and Admissibility van 1 juni 2007
Candidate Authors	Kandidaat-auteurs	The three Tribunal members and Mr Valasek as potential authors of the Final Awards, investigated by dr. Chaski <hr/> De drie leden van het Scheidsgerecht en de heer Valasek onderzocht door dr. Chaski, als mogelijke auteurs van de Final Awards
(Taxation) carve-out	Carve-out (of: uitsluiting voor belasting)	As follows from Article 21(1) ECT <hr/> Zoals volgt uit artikel 21 lid 1 ECT
CETA treaty	CETA-verdrag	<u>EU-Canada Comprehensive Economic Trade Agreement</u> <u>Handelsverdrag tussen de EU en Canada</u>
Chaski Report	Chaski Report	"Expert Report Regarding Authorship of the Final Awards", Expert report of dr. Chaski, leading scholar in the field of forensic linguistics dated September 11, 2015 <hr/> "Expert Report Regarding Authorship of the Final Awards", Onderzoeksrapport van de forensische linguïst dr. Chaski van 11 september 2015
Claimants	Eiseressen	<u>Hulley, VPL, and YUL together</u> <u>Hulley, VPL en YUL tezamen</u>
Claim. Cl	Claim. Cl	<u>Claimants' Closing Statement, presented during the Hearing on the Merits</u> <u>De Closing Statement van Eiseressen, voorgedragen tijdens de Hearing on the Merits</u>
Claim. Skel.	Claim. Skel.	<u>Claimants' Merits Skeleton Argument, October 1, 2012</u> <u>Het Merits Skeleton Argument van Eiseressen, 1 oktober 2012</u>
(Expropriation) Claw-back	Claw-back (of: uitsluiting voor onteigenende belastingen)	As follows from Article 21(5) ECT <hr/> Zoals volgt uit artikel 21 lid 5 ECT
Competent Tax Authorities	Competent Tax Authorities	<u>As defined in Article 21(7)(c) ECT</u> <u>Zoals gedefinieerd in artikel 21 lid 7 sub c ECT</u>
Constitution (or Russian	Grondwet (of Russische	<u>The Constitution of the Russian Federation, 1993</u>

UNOFFICIAL TRANSLATION

This text is an unofficial translation of the Dutch original. In case of any discrepancies, the Dutch original shall prevail.

Constitution)	Grondwet of Grondwet van de Russische Federatie)	De Grondwet van de Russische Federatie, 1993
Contracting Parties (or Contracting States)	Verdragsluitende Partijen (of Verdragsluitende Staten of Contracting Parties of Contracting States)	Two or more parties (States and/or the EU, as the case may be) that have signed a treaty (the ECT, VCLT or ICSID Convention, as the case may be) <hr/> Twee of meer partijen (al dan niet Staten en/of de EU) die een verdrag (al dan niet de ECT, het WVV of het ICSID-Verdrag) hebben ondertekend)
Council of the Federation	Raad van de Federatie	The upper chamber of the Federal Assembly of the Russian Federation <hr/> De eerste kamer van het Federale Parlement van de Russische Federatie
District Court (or Court or Your Honour's Court)	Rechtbank	The Hague District Court (unless explicitly stated otherwise) <hr/> Rechtbank Den Haag (tenzij uitdrukkelijk anders bepaald)
Cullen Rep.	Cullen Report	Expert Report of F. Cullen, April 4, 2011 <hr/> Deskundigenbericht F. Cullen, 4 april 2011
DCCP	Rv	The Dutch Code of Civil Procedure <hr/> Het wetboek van Burgerlijke Rechtsvordering
DCF	DCF	Discounted Cash Flow <hr/> Discounted Cash Flow (verdisconteerde kasstromen)
Defendant	Gedaagde	Hulley, VPL, or YUL, as the case may be <hr/> Al dan niet Hulley, VPL of YUL
Dividends	Dividenden	"but for"-dividends: the hypothetical dividends that, according to the Tribunal, HVY would have received "but for" Yukos' expropriation <hr/> "but for"-dividenden: de hypotetische dividenden die HVY volgens het Scheidsgerecht ontvangen zouden hebben "but for" Yukos' onteigening
Dow Report (or Report)	Dow Report	Professor James Dow's expert report submitted with the Writ as Exhibit RF-85 <hr/> Het deskundigenbericht van professor James Dow, als Productie RF-85 bij de Dagvaarding gevoegd
DTA	DTA	Cyprus-Russia Double Taxation Agreement <hr/> Verdrag inzake Dubbele Belasting tussen Cyprus en Rusland
Duma (or Russian Duma or State Duma)	Doema (of Russische Doema)	The lower chamber of the Federal Assembly of the Russian Federation <hr/> De tweede kamer van het Federale Parlement van de Russische Federatie
EBITDA	EBITDA	A company's revenues minus all of its expenses except for interest, taxes, depreciation, and amortization <hr/> De verdiensten van een onderneming voor aftrek van interest, belastingen, afschrijvingen op activa en afschrijvingen op

UNOFFICIAL TRANSLATION

This text is an unofficial translation of the Dutch original. In case of any discrepancies, the Dutch original shall prevail.

		leningen en goodwill
ECHR (or European Convention on Human Rights)	EVRM	The European Convention for the Protection of Human Rights and Fundamental Freedoms Het Europees Verdrag tot bescherming van de rechten van de mens en de fundamentele vrijheden
ECT (or Treaty Energy Charter Treaty)	ECT (of Verdrag)	The Energy Charter Treaty, 2080 UNTS 95, signed on December 17, 1994 Het Energiehandvestverdrag, 2080 UNTS 95, ondertekend op 17 december 1994
ECtHR (or Court)	EHRM	The European Court of Human Rights Het Europees Hof voor de Rechten van de Mens
<i>EnCana</i>	<i>EnCana</i>	<i>EnCana Corporation v. Republic of Ecuador</i> , LCIA, UNCITRAL Award, February 3, 2006 <i>EnCana Corporation v. Republic of Ecuador</i> , LCIA, UNCITRAL Arbitraal vonnis, 3 februari 2006
Energotrade	Energotrade	Mordovian sham company of Yukos Mordovische schijnvennootschap van Yukos
EPH	EPH	East Petroleum Handelgas East Petroleum Handelgas
Equity value	Eigenvermogenswaarde	"but for"-equity value: the hypothetical equity value that, according to the Tribunal, Yukos would have had "but for" its expropriation "but for"-eigenvermogenswaarde: de hypothetische eigenvermogenswaarde die Yukos volgens het Scheidsgerecht gehad zou hebben "but for" Yukos' onteigening
European Energy Charter Conference	Conferentie van/over het (Europese) Energiehandvest (of Europese Energieconferentie of Energy Charter Conference)	The European Energy Conference at which the ECT was negotiated De Europese Energieconferentie waar de ECT werd uitonderhandeld
Evenkia	Evenkia	One of the low-tax regions in the Russian Federation Een van de lage belastingregio's in de Russische Federatie
Explanatory Note (or 1996 Explanatory Note)	(1996) Memorie van Toelichting	The Explanatory Note submitted by the Russian Government in 1996 as part of its (failed) attempt to persuade the State Duma to ratify the ECT; Explanatory Note to the Draft Federal Law On Ratification of the Energy Charter Treaty De memorie van toelichting die door de Russische regering in 1996 is ingediend als onderdeel van zijn (mislukte) poging om het Russische Parlement (de Doema) over te

UNOFFICIAL TRANSLATION

This text is an unofficial translation of the Dutch original. In case of any discrepancies, the Dutch original shall prevail.

		halen de ECT te bekrachtigen; Explanatory Note to the Draft Federal Law On Ratification of the Energy Charter Treaty
Expropriation	Onteigening	As defined in Article 13(1) ECT Als gedefinieerd in artikel 13 lid 1 ECT
Federal Assembly	Federale Parlement	The national legislature of the Russian Federation, consisting of an upper chamber (Council of the Federation) and a lower chamber (Duma) De nationale wetgever van de Russische Federatie, bestaand uit een eerste kamer (Raad van de Federatie) en een tweede kamer (Doema)
Final Awards	Final Awards	The Final Awards issued on July 18, 2014 in these three Arbitrations (PCA Case Nos. AA226 (Hulley), AA227 (YUL) and AA228 (VPL)) De Final Awards, arbitrale vonnissen die op 18 juli 2014 zijn gewezen in deze drie Arbitrages (PCA zaaknr. AA226 (Hulley), AA227 (YUL) and AA228 (VPL))
First Dow Report	First Dow Report	Expert Report of James Dow, April 1, 2011 Deskundigenbericht van James Dow, 1 april 2011
First ECtHR Ruling	Eerste EHRM Uitspraak	<i>OAO Neftyanaya Kompaniya Yukos v. Russia</i> , EctHR, Appl. No. 14902/04, Judgment, September 20, 2011 <i>OAO Neftyanaya Kompaniya Yukos v. Russia</i> , EctHR, Appl. No. 14902/04, uitspraak, 20 september 2011
First Kaczmarek Report	First Kaczmarek Report	Expert Report of Brent C. Kaczmarek, September 15, 2010 Deskundigenbericht Brent C. Kaczmarek, 15 september 2010
First Konnov Report	Konnov Report 1	Expert Report of Oleg Y. Konnov, April 1, 2011 Deskundigenbericht van Oleg Y. Konnov, 1 april 2011
First Rosenbloom Report	First Rosenbloom Report	Expert Report of H. David Rosenbloom of April 1 2011 Eerste deskundigenbericht van H. David Rosenbloom van 1 April 2011
FLIT	FLIT	Federal Law on International Treaties of the Russian Federation, 1995 Federale wet over internationale verdragen van de Russische Federatie, 1995
France-Singapore BIT	Het BIT tussen Frankrijk en Singapore	Agreement between the Government of the French Republic and the Government of the Republic of Singapore for the Promotion and Reciprocal Protection of Investments, with three exchanges of letters, 1975 Overeenkomst tussen de regering van de Franse Republiek en de regering van de Republiek Singapore voor de promotie en de bescherming over een weer van investeringen, met drie briefwisselingen, 1975
Free Cash Flow to Equity	Free Cash Flow to Equity	The hypothetical cash flow that Mr Kaczmarek's DCF model assumed would be available to Yukos' shareholders, in order to calculate Claimants' second head of damages (their share of the hypothetical dividends that Yukos would have paid between 2004 and November 21, 2007)

UNOFFICIAL TRANSLATION

This text is an unofficial translation of the Dutch original. In case of any discrepancies, the Dutch original shall prevail.

		De hypothetische kasstromen die volgens het DCF model van de heer Kaczmarek aan Yukos' aandeelhouders ter beschikking zou staan op basis waarvan de tweede door Eiseressen aangevoerde schadepost (het aandeel van Eiseressen in de hypothetische dividenden die Yukos zou hebben uitbetaald tussen 2004 en 21 november 2007) kon worden berekend
Fremantle Opinion	Fremantle Opinion	S. Fremantle Opinion Concerning the Provisional Application of the Energy Charter Treaty, January 21, 2007 Deskundigenbericht S. Fremantle over de voorlopige toepassing van de ECT, 21 januari 2007
GATT	GATT	General Agreement on Tariffs and Trade, 1994 General Agreement on Tariffs and Trade (Wereldovereenkomst voor Tarieven en Handel), 1994
GMI	GMI	Group Menatep Investments (a subsidiary of GML) Group Menatep Investments (een dochtervennootschap van GML)
GML	GML	GML Limited (formerly named Group Menatep Limited), a company incorporated in Gibraltar and parent company of YUL GML Limited (voorheen geheten Group Menatep Limited), een vennootschap opgericht naar het recht van Gibraltar en moedervernootschap van YUL
Hart Rep.	Hart Report	Expert Report of Dale Hart, April 4, 2011 Deskundigenbericht Dale Hart, 4 april 2011
HEL Interim Award	HEL Interim Award	The Interim Award on Jurisdiction and Admissibility issued on 30 November 2009 in PCA Case No. AA226 De Interim Award on Jurisdiction and Admissibility, arbitraal vonnis op 30 november 2009 gewezen in de PCA arbitrage met nummer AA226
Hulley (or: HEL)	Hulley (of: HEL)	Hulley Enterprises Limited, a company organized under the laws of Cyprus and Claimant in PCA Case No. AA226, shareholder of Yukos, owned by YUL Hulley Enterprises Limited, een vennootschap opgericht naar het recht van Cyprus en eiseres in de PCA-arbitrage, zaaknr. 226, aandeelhouder van Yukos, eigendom van YUL
HVY	HVY	Hulley, VPL, and YUL together Hulley, VPL en YUL tezamen
ICJ	ICJ	International Court of Justice Internationaal Gerechtshof
ICSID	ICSID	International Centre for the Settlement of Investment Disputes
ICSID Convention	ICSID-Verdrag	Convention on the Settlement of Investment Disputes Between States and Nationals of Other States, 1965 Verdrag voor de Beslechting van Investeringsgeschillen tussen Staten en Onderdanen van andere Staten, 1965
ILC	ILC	International Law Commission Commissie voor Internationaal Recht

UNOFFICIAL TRANSLATION

This text is an unofficial translation of the Dutch original. In case of any discrepancies, the Dutch original shall prevail.

IMR	IMR	Institute for Modern Russia Insitute for Modern Russia
Interim Awards	Interim Awards	The Interim Awards on Jurisdiction and Admissibility issued on 30 November 2009 in these three Arbitrations (PCA Case Nos. AA226 (Hulley), AA227 (YUL) and AA228 (VPL)) De Interim Awards on Jurisdiction and Admissibility, arbitrale vonnissen die op 30 november 2009 zijn geweest in deze drie Arbitrages (PCA zaaknrs. AA226 (Hulley), AA227 (YUL) and AA228 (VPL))
Investment	Investering	As defined under Article 1(6) ECT Zoals gedefinieerd in artikel 1 lid 6 ECT
Investor	Investeerder	As defined under Article 1(7) ECT Zoals gedefinieerd in artikel 1 lid 7 ECT
IPPA	IPPA	Agreement for the Promotion and Protection of Investments Overeenkomst ter bevordering en bescherming van investeringen
Judgment	Vonnis	Judgment of 20 April 2016 in which the District Court set aside the Yukos Awards (unless explicitly stated otherwise) Vonnis van 20 april 2016 waarin de Rechtbank de Yukos Awards heeft vernietigd (tenzij uitdrukkelijk anders bepaald)
Kalmykia	Kalmukkië (of Kalmykia)	One of the low-tax regions in the Russian Federation Een van de lage belastingregio's in de Russische Federatie
Koskenniemi Expert Opinion	Koskenniemi Opinion	M. Koskenniemi Expert Opinion on the Provisional Application of International Treaties in the Finnish Constitutional Law Context, Especially with Regard to the Energy Charter Treaty, October 27, 2006 Deskundigenbericht M. Koskenniemi over de voorlopige toepassing van internationale verdragen in de context van het Finse recht, in het bijzonder met betrekking tot de ECT, 27 oktober 2006
Kostin Expert Opinion	Kostin Opinion	A.A. Kostin Opinion on Certain Issues of Arbitrability, February 21, 2006 Deskundigenbericht A.A. Kostin over bepaalde zaken aangaande arbitrabiliteit, 21 februari 2006
Kraakman Report	Kraakman Report	Expert Report of Professor Reinier Kraakman, April 1, 2011 Deskundigenbericht van professor Reinier Kraakman, 1 april 2011
Laguna	Laguna	A sham company established by Bank Menatep Een schijnvennootschap opgericht door Menatep Bank
Law(s) on Foreign Investment (of Russian Laws on Foreign Investment)	RFW Buitenlandse Investerings (of Wet op de Buitenlandse Investerings)	The 1991 Law on Foreign Investment and/or the 1995 / 1999 Law on Foreign Investment of the Russian Federation, as the case may be De Federale Wet inzake Buitenlandse Investerings van de Russische Federatie uit 1991 en/of 1995 / 1999

UNOFFICIAL TRANSLATION

This text is an unofficial translation of the Dutch original. In case of any discrepancies, the Dutch original shall prevail.

Lesnoy	Lesnoy	One of the low-tax regions in the Russian Federation Een van de lage belastingregio's in de Russische Federatie
Limitation Clause	Limitation Clause	The phrase at the end of Article 45(1) of the ECT: “. . . to the extent not inconsistent with its constitution, laws or regulations.” De zinsnede aan het eind van artikel 45 lid 1 ECT: “. . . to the extent not inconsistent with its constitution, laws or regulations.”
Lisitsyn-Svetlanov Expert Opinion	Lisitsyn-Svetlanov Opinion	Opinion of Professor A.G. Lisitsyn-Svetlanov, February 22, 2006 Deskundigenbericht van professor A.G. Lisitsyn-Svetlanov, 22 februari 2006
Lukashuk Expert Opinion	Lukashuk Opinion	I.I. Lukashuk Opinion on Provisional Application of the Energy Charter Treaty Deskundigenbericht I.I. Lukashuk over voorlopige toepassing van de ECT
Martynov Opinion	Martynov Opinion	A. Martynov Opinion Concerning Provisional Application of the Energy Charter Treaty, December 14, 2006 Deskundigenbericht A. Martynov over voorlopige toepassing van de ECT, 14 december 2006
Menatep Group	Menatep Group (of Menatep Groep)	Group Menatep Limited (now named GML), a company incorporated in Gibraltar and parent company of YUL Group Menatep Limited (nu genaamd GML), een vennootschap opgericht naar het recht van Gibraltar en moedervennootschap van YUL
Misam. Test.	Misamore Testimony	Bruce Kelvern Misamore's testimony during the Hearing on the Merits De getuigenverklaring van Bruce Kelvern Misamore tijdens de Hearing on the Merits
Mordovia	Mordovië (of Mordovia)	One of the low-tax regions in the Russian Federation Een van de lage belastingregio's in de Russische Federatie
NAFTA	NAFTA	North American Free Trade Agreement, 1992 Noord-Amerikaanse Vrijhandelsovereenkomst, 1992
Nassaubridge	Nassaubridge	Nassaubridge Management Limited Nassaubridge Management Limited
Nolte Expert Opinion	Nolte Opinion	G. Nolte Opinion Concerning Provisional Application of Article 26 of the Energy Charter Treaty from an International and German Constitutional Law Perspective, October 31, 2006 Deskundigenbericht G. Nolte over voorlopige toepassing van artikel 26 ECT vanuit een internationaal en Duits constitutioneelrechtelijk perspectief, 31 oktober 2006
Nußberger Expert Opinion	Nussberger Opinion	A. Nußberger Opinion Concerning the Provisional Application of the Energy Charter Treaty by the Russian Federation, January 17, 2007 Deskundigenbericht A. Nussberger over de voorlopige toepassing van de ECT door de Russische Federatie, 17 januari 2007

UNOFFICIAL TRANSLATION

This text is an unofficial translation of the Dutch original. In case of any discrepancies, the Dutch original shall prevail.

NYSE	NYSE	New York Stock Exchange New York Stock Exchange
OECD	OESO (of OECD)	Organisation for Economic Co-operation and Development Organisatie voor Economische Samenwerking en Ontwikkeling
PCA	PCA	Permanent Court of Arbitration Permanent Court of Arbitration (Permanent Hof van Arbitrage)
Pellet Expert Opinion	Pellet Opinion	A. Pellet Legal Opinion on the Provisional Application of a Treaty under French Constitutional Law (Taking the Example of the Energy Charter Treaty), December 13, 2006 Deskundigenbericht A. Pellet over de voorlopige toepassing van een verdrag onder Frans constitutioneel recht (met als voorbeeld de ECT), 13 december 2006
PwC	PwC	PricewaterhouseCoopers, the former auditor of Yukos PricewaterhouseCoopers, de voormalige accountant van Yukos
R-	R-	Exhibits submitted by the Russian Federation with its Statements of Defense dated October 15, 2005, First Memorials on Jurisdiction and Admissibility dated February 28, 2006, and Second Memorials on Jurisdiction and Admissibility dated January 31, 2007 Producties ingediend door de Russische Federatie in haar Statements of Defense van 15 oktober 2005, First Memorials on Jurisdiction and Admissibility van 28 februari 2006 en Second Memorials on Jurisdiction and Admissibility van 31 januari 2007
Red Directors	Red Directors	A group of public officials (Muravlenko, Ivanenko, Kazakov en Golubev) who were the directors of Yukos before the privatization Een groep ambtenaren (Muravlenko, Ivanenko, Kazakov en Golubev) die de bestuurders waren van Yukos voor de privatisering
Regent	Regent	A sham company established by Bank Menatep Een schijnvennootschap opgericht door Menatep Bank
Representative Sections	Representatieve Hoofdstukken	Section IX (Preliminary Objections), Section X (Liability) and Section XII (The Quantification of Claimant's Damages) of the Final Awards as applied by dr. Chaski to her statistical model Hoofdstuk IX (Preliminary Objections), Hoofdstuk X (Liability) en Hoofdstuk XII (The Quantification of Claimant's Damages) van de Final Awards, waarop dr. Chaski haar statistische model op toegepast heeft
Respondent	Gedaagde	The Russian Federation or Russia De Russische Federatie of Rusland
Resp. C-Mem. (or Resp-C-Mem. On The Merits)	Respondent's Counter-Memorial (of Respondent's Counter-Memorial On	The Russian Federation's Counter-Memorial on the merits, resubmitted on July 29, 2011 De door de Russische Federatie ingediende Counter-Memorial in de hoofdzaak, opnieuw ingediend op 29 juli 2011

UNOFFICIAL TRANSLATION

This text is an unofficial translation of the Dutch original. In case of any discrepancies, the Dutch original shall prevail.

	The Merits)	
Resp. Rej. (or Resp. Rej. On the Merits)	Respondent's Rejoinder (of Respondent's Rejoinder on the Merits	The Russian Federation's Rejoinder on the Merits, submitted on August 16, 2012 De door de Russische Federatie ingediende Rejoinder in de hoofdzaak, ingediend op 16 augustus 2012
Resp. Op. Ppt.	Resp. Op. Ppt.	The Russian Federation's Opening Presentations, presented during the Hearing on the Merits De Opening Presentations van de Russische Federatie, voorgedragen tijdens de Hearing on the Merits
Resp. Reb. Ppt.	Resp. Reb. Ppt	The Russian Federation's Rebuttal Presentations, presented during the Hearing on the Merits De Rebuttal Presentations van de Russische Federatie, voorgedragen tijdens de Hearing on the Merits
Resp. Cl. Ppt	Resp. Cl. Ppt	The Russian Federation's Closing Presentations, presented during the Hearing on the Merits De Closing Presentations van de Russische Federatie, voorgedragen tijdens de Hearing on the Merits
Resp. Cl	Resp. Cl	The Russian Federation's Closing Statement, presented -during the Hearing on the Merits De Closing Statement van de Russische Federatie, voorgedragen tijdens de Hearing on the Merits
Resp. PHB.	Resp. PHB.	The Russian Federation's Post-Hearing Brief, December 21, 2012 De Post-Hearing Brief van de Russische Federatie, 21 december 2012
	RGBV	Treaties (Approval and Publication) Kingdom Act Rijkswet goedkeuring en bekendmaking verdragen
RME-	RME-	Exhibits submitted by the Russian Federation with its Counter-Memorial on the Merits resubmitted on July 29, 2011 and Rejoinder on the Merits dated August 16, 2012 Producties ingediend door de Russische Federatie in haar Counter-Memorial on the Merits, opnieuw ingediend op 29 juli 2011, en Rejoinder on the Merits van 16 augustus 2012
First Rosenbloom Report	First Rosenbloom Report	Expert Report of H. David Rosenbloom of April 1, 2011 Eerste deskundigenbericht van H. David Rosenbloom van 1 april 2011.
<i>RosInvestCo</i>	<i>RosInvestCo</i>	RosInvestCo UK Ltd. v. The Russian Federation, SCC Arbitration V (079/2005), Final Award, September 12, 2010 RosInvestCo UK Ltd. v. The Russian Federation, SCC Arbitration V (079/2005), Arbitraal eindvonnis, 12 september 2010
Rosneft	Rosneft	OJSC Rosneft Oil Company OJSC Rosneft Oil Company
RSFSR	RSFSR	Russian Soviet Federative Socialist Republic

UNOFFICIAL TRANSLATION

This text is an unofficial translation of the Dutch original. In case of any discrepancies, the Dutch original shall prevail.

		Russische Socialistische Federatieve Sovjetrepubliek
RTS Index	RTS Index	The RTS Oil and Gas Index, one of the sectoral indices of the Russia Trading System De RTS Oil and Gas Index, een van de sectorindices van het Russische handelssysteem
RTT	RTT	SP Russian Trust and Trade SP Russian Trust and Trade
Russia-Cyprus Double Taxation Treaty (or Treaty)	Russia-Cyprus Double Taxation Treaty (of Russisch Cypriotische DTA	Russia-Cyprus Income and Capital Tax Agreement, December 5, 1998 Rusland-Cyprus overeenkomst inzake inkomsten- en kapitaalbelasting, 5 december 1998
Russia-Hungary BIT	Russia-Denmark BIT	Agreement between the Government of the Russian Federation and the Government of the Kingdom of Denmark Concerning the Promotion and Reciprocal Protection of Investments, 1993 Overeenkomst tussen de regering van de Russische Federatie en de regering van het Koninkrijk Denemarken over de promotie en bescherming van investeringen over en weer, 1993
Russia (or the Russian Federation)	Russische Federatie	The Russian Federation De Russische Federatie
Russian Constitution (or Constitution)	Russische Grondwet	Constitution of the Russian Federation, 1993 Grondwet van de Russische Federatie, 1993
Russian Oligarchs	Russische Oligarchen	Russian nationals (Khodorkovski, Lebedev, Nevzlin, Brudno, Dubov, Golubovich and Shaknovsky) who own and control the Yukos companies, including HVY Russische personen (Khodorkovski, Lebedev, Nevzlin, Brudno, Dubov, Golubovich en Shaknovsky) die eigenaar zijn van en controle hebben over de Yukos vennootschappen, waaronder HVY
Russian Tax Code (or Tax Code)	Russische Belastingwet	Tax Code of the Russian Federation Belastingwet van de Russische Federatie
Second Dow Report	Second Dow Report	Second Expert Report of James Dow, August 15, 2012 Tweede deskundigenbericht James Dow, 15 augustus 2012
Second ECtHR Ruling	Tweede EHRM Uitspraak	<i>Khodorkovskiy and Lebedev v. Russia</i> , ECtHR, Appls. Nos. 11082/06 and 13772/05, Judgment, July 25, 2013 <i>Khodorkovskiy and Lebedev v. Russia</i> , ECtHR, Appls. Nos. 11082/06 and 13772/05, uitspraak, 25 juli 2013
Second Kaczmarek Report	Second Kaczmarek Report	Second Expert Report of Brent C. Kaczmarek, March 15, 2012 Tweede deskundigenbericht Brent C. Kaczmarek, 15 maart 2012
Second Konnov Report	Konnov Report 2 (of Second	Second Export Report of Oleg Y. Konnov, August 15, 2012 Tweede deskundigenbericht van Oleg Y. Konnov, 15 augustus 2012

UNOFFICIAL TRANSLATION

This text is an unofficial translation of the Dutch original. In case of any discrepancies, the Dutch original shall prevail.

	Konnov Report of Second Expert Report of Oleg Konnov)	
Secretariat	Secretariaat	The secretariat of the PCA <hr/> Het secretariaat van het PCA
Sibneft	Sibneft	Russia's fifth largest oil company in 2003 <hr/> Het op vier na grootste oliebedrijf in Rusland in 2003
Statement of Defence (or: SoD)	Conclusie van Antwoord (of: CvA)	HVY's Statement of Defence dated May 20, 2015 <hr/> HVY's Conclusie van Antwoord d.d. 20 mei 2015
Sukhanov Expert Opinion	Sukhanov Opinion	Y.A. Sukhanov Opinion on the Issue of Possibility of a Shareholder's Claims Against Counter-Parties of the Joint-Stock Company in Connection with Damage Caused by the Latter to the Company, February 22, 2006 <hr/> Deskundigenbericht Y.A. Sukhanov over de mogelijkheid om een aandeelhoudersvordering in te stellen tegen wederpartijen van een vennootschap met betrekking tot schade door deze wederpartij veroorzaakt aan de vennootschap, 22 februari 2006
Supreme Arbitrazh Court of the RSFSR	Supreme Arbitrazh Court of the RSFSR	Supreme Court of the RSFSR <hr/> Hooggerechthof in Handelszaken van de USSR
Taxation Measures	Taxation Measures (of Belastingmaatregelen)	As defined under Article 21(7)(a) ECT <hr/> Zoals gedefinieerd in artikel 21 lid 7 sub a ECT
Tax Code (or Russian Tax Code)	Tax Code (of Russian Tax Code)	Tax Code of the Russian Federation <hr/> Belastingwet van de Russische Federatie
Theede Test.	Theede Testimony	Steven Theede's testimony during the Hearing on the Merits <hr/> De getuigenverklaring van Steven Theede tijdens de Hearing on the Merits
Treaty (or ECT)	Verdrag (of ECT)	Energy Charter Treaty, 2080 UNTS 95, signed on December 17, 1994 <hr/> Het Energiehandvestverdrag, 2080 UNTS 95, ondertekend op 17 december 1994
Trekhgorny	Trekhgorny	One of the low-tax regions in the Russian Federation <hr/> Een van de lage belastingregio's in de Russische Federatie
Tribunal	Scheidsgerecht	The tribunal, consisting of Fortier, Poncet (as of September 24, 2007, replacing Price who resigned as arbitrator on May 31, 2007) and Schwebel, that rendered the Interim Awards and the Final Awards <hr/> Het scheidsgerecht, bestaand uit Fortier, Poncet (vanaf 24 september 2007, als vervanger van Price die aftrad als arbiter op 31 mei 2007) en Schwebel, die de Interim Awards en de Final Awards hebben gewezen

UNOFFICIAL TRANSLATION

This text is an unofficial translation of the Dutch original. In case of any discrepancies, the Dutch original shall prevail.

UK-Soviet BIT	Verdrag tussen het Verenigd Koninkrijk en de USSR	Agreement Between the Government of the United Kingdom of Great Britain and Northern Ireland and the Government of the Union of Soviet Socialist Republics Regarding the Mutual Encouragement and Protection of Investments, 1989 Overeenkomst tussen de regering van het Verenigd Koninkrijk van Groot-Brittannië en Noord-Ierland en de regering van de Unie van Socialistische Sovjetrepublieken over de promotie en bescherming van investeringen over en weer, 1989
UNCITRAL	UNCITRAL	United Nations Commission on International Trade Law Commissie van de Verenigde Naties voor Internationaal Handelsrecht (United Nations Commission on International Trade Law)
UNCITRAL Rules (or UNCITRAL Arbitration Rules)	UNCITRAL Rules (of UNCITRAL Arbitration Rules)	Arbitration Rules of the United Nations Commission on International Trade Law, 1976 Arbitrageregels van de Commissie van de Verenigde Naties voor Internationaal Handelsrecht, 1976
USD	USD	United States dollar De Dollar van de Verenigde Staten
USSR	USSR	Union of Soviet Socialist Republics Unie van Socialistische Sovjetrepublieken
USSR FLIT	USSR International e Verdragen	The Law of the USSR dated July 6, 1978 “On the Procedure for Conclusion, Performance, and Denunciation of International Treaties of the USSR” De Wet van de USSR van 6 juli 1978 “On the Procedure for Conclusion, Performance, and Denunciation of International Treaties of the USSR”
Valuation Date	Datum van de Waardebepaling	The fair market value of the Investment expropriated at the time immediately before the Expropriation or impending Expropriation became known in such a way as to affect the value of the Investment (Article 13(1) ECT) De billijke marktwaarde van de onteigende investering op het tijdstip vlak voordat de onteigening of op handen zijnde onteigening zodanig bekend werd dat de investeringswaarde werd beïnvloed (artikel 13 lid 1 ECT)
VAT	BTW	Value Added Tax Belasting Toegevoegde Waarde
VCLT (or Vienna Convention on the Law of Treaties)	WVV (of Weens Verdragenverdrag)	Vienna Convention on the Law of Treaties, 1155 UNTS 331, signed on May 23, 1969 Weens Verdragenverdrag, 1155 UNTS 331, ondertekend op 23 mei 1969
VPL	VPL	Veteran Petroleum Limited, a company organized under the laws of Cyprus and Claimant in PCA Case No. AA 228, shareholder of Yukos Veteran Petroleum Limited, een vennootschap opgericht naar het recht van Cyprus en eiseres in de PCA-arbitrage, zaaknr. 228, aandeelhouder van Yukos
VP Trust	VP Trust	The Veteran Petroleum Trust

UNOFFICIAL TRANSLATION

This text is an unofficial translation of the Dutch original. In case of any discrepancies, the Dutch original shall prevail.

		De Veteran Petroleum trust
VP Trust Agreement	VP Trust Agreement	Appointment of Custodian Trustee in respect of "the Veteran Petroleum Trust", April 25, 2001 Overeenkomst inzake Appointment of Custodian Trustee in respect of "the Veteran Petroleum Trust", April 25, 2001
Writ	Dagvaarding	The writ of summons dated November 10, 2014 Dagvaarding d.d. 10 November 2014
YNG	YNG	Yuganskneftegaz, a former production subsidiary of Yukos Yuganskneftegaz, een voormalig productiedochtermaatschappij van Yukos
Yukos (or YUKOS or Yukos Oil Company or OAO Yukos Oil Company)	Yukos (of YUKOS of Yukos Oil Company of OAO Yukos Oil Company)	OAO Yukos Oil Company, a joint stock company incorporated in Russia in 1993 OAO Yukos Oil Company, een joint stock company opgericht in Rusland in 1993
Yukos Awards	Yukos Awards	The Interim Awards and the Final Awards together De Interim Awards en de Final Awards tezamen
YukosSibneft	YukosSibneft	A fictitious entity that Claimants asserted would have resulted from the proposed (but never consummated) merger of Yukos and Sibneft Een fictieve entiteit die volgens Eiseressen het resultaat zou zijn van de beoogde (maar nooit voltrokken) fusie tussen Yukos en Sibneft
Yukos Stichting (or Stichtings)	Yukos Stichting (of Stichtings)	Stichting Administratiekantoor Yukos International and Stichting Administratiekantoor Financial Performance Holdings Stichting Administratiekantoor Yukos International en Financial Performance Holdings
YUL	YUL	Yukos Universal Limited, a company organized under the laws of the Isle of Man and Claimant in PCA No. AA 227, shareholder of Yukos Yukos Universal Limited, een vennootschap opgericht naar het recht van de Isle of Man en eiseres in de PCA-arbitrage, zaaknr. 227, aandeelhouder van Yukos
ZATO	ZATO	Zakrytoe Administrativno-Territorial'noe Obrazovaniye, or Closed Administrative Territorial Unit Zakrytoe Administrativno-Territorial'noe Obrazovaniye, oftewel gesloten territorial administratieve unit

XII. LIST OF (LEGAL) AUTHORITIES (SECONDARY)

CITATION	AUTHORITIES	EXHIBIT
Ageshkina 2013	N.A. Ageshkina, Academic And Practical Commentary To Federal Law No. 101-FZ "On International Treaties Of The Russian Federation" Dated July 15, 1995, 2013	Exhibit RF-128
Alibekova & Carrow 2007	A. Alibekova & R. Carrow (eds.), <i>International Arbitration and Mediation – From The Professional Perspective</i> , Yorkhill Law Publishing 2007	Exhibit RF-336
Alvarez 2011	J. E. Alvarez, <i>The Public International Law Regime Governing International Investment</i>, 344 Collected Courses of The Hague Academy of International Law, 2011	Exhibit RF-142
Aptel 2012	C. Aptel, 'Prosecutorial Discretion at the ICC and Victims' Right to Remedy: Narrowing the Impunity Gap', <i>Journal of International Criminal Justice</i> 2012, Vol. 10 Issue 5	Exhibit RF-372
Arsanjani & Reisman 2011	M. H. Arsanjani & W. M. Reisman, 'Provisional Application of Treaties in International Law: The Energy Charter Treaty Awards', in: E. Cannizzaro (red.), <i>The Law of Treaties Beyond the Vienna Convention</i> , Oxford: Oxford University Press 2011	Exhibit RF-21
Articles on Responsibility of States for Internationally Wrongful Acts with commentaries 2001	Articles on Responsibility of States for Internationally Wrongful Acts with commentaries (Text adopted by the International Law Commission at its fifty-third session, in 2001), Yearbook of the International Law Commission, 2001, vol. II, Part Two	Exhibit RF-156
Asser 1998	Commentaar van Asser op Gerechtshof Amsterdam 12 november 1998, TvA, 2001	
Asser 2004	W.D.H. Asser, <i>Bewijslastverdeling, Serie Burgerlijk Proces en Praktijk</i> , deel. 3, 2004	
Asser 2013	W.D.H. Asser, 'Beginselen van een faire arbitrale rechtspleging', <i>TvA</i> 2013/40	
Asser 2013A	Asser <i>Procesrecht/Asser 3</i> 2013	
Asser/Maeijer/Van Solinge & Nieuwe Weme 2-II* 2009	G. van Solinge & M.P. Nieuwe Weme (m.m.v. R.G.J. Nowak), <i>Mr. C. Assers Handleiding tot de beoefening van het Nederlands Burgerlijk Recht. 2. Vertegenwoordiging en rechtspersoon. Deel II. De rechtspersoon</i> , Deventer: Kluwer 2009	
Asser/Scholten Algemeen Deel* 1974	P. Scholten, <i>Mr. C. Asser's Handleiding tot de beoefening van het Nederlands Burgerlijk Recht. Algemeen Deel</i> , Zwolle: W.E.J. Tjeenk Willink 1974	
Aust 2007	A.Aust, <i>Modern Treaty Law and Practice</i>, 2007	Exhibit RF-149
Auswärtiges Amt, Richtlinien für die Behandlung	Auswärtiges Amt, <i>Richtlinien für die Behandlung völkerrechtlicher Verträge – Neufassung</i> (German Federal Foreign Office, Guidelines on the Treatment of	Exhibit RF-30

UNOFFICIAL TRANSLATION

This text is an unofficial translation of the Dutch original. In case of any discrepancies, the Dutch original shall prevail.

CITATION	AUTHORITIES	EXHIBIT
völkerrechtlicher Verträge – Neufassung 2004	International Treaties – New version), Berlijn 2004	
Balkhaeva 2011	S.B. Balkhaeva, <i>Types Of Entry Into Force Of International Treaties Of The Russian Federation</i>, 8 <i>Journal of Russian Law</i>, 2011	Exhibit RF-130
Bamberger 1996	C. S. Bamberger, Epilooq: 'The Energy Charter Treaty As A Work In Progress', in: T. Wälde (red.), <i>The Energy Charter Treaty – An East-West Gateway for Investment and Trade</i> , Londen: Kluwer Law International 1996	Exhibit RF-38
Bamberger 2006	C.S. Bamberger, 'Adjudicatory Aspects of Transit Dispute Conciliation Under The Energy Charter Treaty', <i>Transnational Dispute Management</i> 2006/3(2)	R-866
Banifatemi 2011	Y. Banifatemi, 'Provisional application of the Energy Charter Treaty: the negotiation history of Article 45' in Graham Coop (ed.) <i>Energy Dispute Resolution: Investment Protection, Transit and the Energy Charter Treaty</i> , 2011	Exhibit RF-250
Baradaran 2014	S. Baradaran e.a., 'Funding Terror', <i>Pennsylvania Law Review</i> 2014, No. 3.	Exhibit RF-330
Barkhatova 2010	E.Y. Barkhatova (red.), <i>Commentary to the Constitution of the Russian Federation</i> , Moskou: Prospekt 2010	Exhibit RF-46
Bekyashev 2001	K.A. Bekyashev, <i>International Public Law, Treatise</i>, 2001	Exhibit RF-127
Berger 2015	K.P. Berger, <i>Part III, 27th Scenario: 'Deliberation of the tribunal and Rendering of the Award'</i> , <i>Private Dispute Resolution in International Business, Negotiation, Mediation, Arbitration (Third Edition)</i> , Kluwer Law International 2015	Exhibit RF-404
Black (e.a.) 2000	B. Black, R. Kraakman & A. Tarassova, 'Russian Privatization and Corporate Governance: What Went Wrong?', <i>Stanford Law Review</i> 2000/52	RME-24
Van Bladel 2002	C.B.E. van Bladel, <i>Arbitrage in de praktijk (diss.) Den Haag: Boom 2002</i>	
De Bock 2011	De Bock, R.H., <i>Tussen waarheid en onzekerheid: over het vaststellen van feiten in de civiele procedure, (diss.)</i>, Deventer: Kluwer 2011	
Born 2014	G.B. Born, <i>International Commercial Arbitration</i> , Londen: Kluwer Law International, 2014	Exhibit RF-90
Bots 2014	A.M.M.M Bots, in 'Het zorgvuldigheidsbeginsel en advisering', in "In beginsel (...)," R.J.N. Schlössels e.a., Deventer: Kluwer 2004	
Bowett 1957	Derek W. Bowett, <i>Estoppel Before International Tribunals and Its Relation to Acquiescence</i>, <i>British Yearbook of International Law</i> 33 (1957)	
Broeders 2007	A.P.A. Broeders, 'De Officier, de deskundige en de schoenmaker', <i>TREMA</i> april 2007-4	
Brownlie 1998	Ian Brownlie, <i>Principles of Public International Law</i> , p. 646 (5th ed. 1998)	

UNOFFICIAL TRANSLATION

This text is an unofficial translation of the Dutch original. In case of any discrepancies, the Dutch original shall prevail.

CITATION	AUTHORITIES	EXHIBIT
Brownlie 2008	I. Brownlie, <i>Principles Of Public International Law</i> , Oxford: Oxford University Press 2008	Exhibit RF-70
Burgstaller 2006	M. Burgstaller, 'Nationality of Corporate Investors and International Claims against the Investor's Own State', <i>The Journal of World Investment & Trade</i> 2006, 857, 860.	Exhibit RF-355
Buruma 1995	S.L. Buruma, 'Capita selecta ter zake van de beslechting van geschillen door de Raad van Arbitrage voor de Bouwbedrijven in Nederland, en andere arbitrage-instituten en de overheidsrechter' in <i>Bouwarbitrage en civiele rechter, preadvies voor de Vereniging voor Bouwrecht</i>, Deventer: Kluwer 1995	Exhibit RF-196
Caflisch 1969	L. Caflisch, <i>La Protection des Sociétés Commerciales et des Intérêts Indirects en Droit International Public</i> , Den Haag: Martinus Nijhoff 1969	R-242
Caflisch 1971	L. Caflisch, 'The Protection of Corporate Investments Abroad in the Light of the Barcelona Traction Case', <i>ZaöeRV</i> 1971/31	R-243
Carreau & Juillard 2013	D. Carreau and P. Juillard, <i>Droit International Economique</i>, 2013	Exhibit RF-140
Cheng 2006	B. Cheng, <i>General Principles of law. As applied by International Courts and Tribunals</i> , Cambridge University Press 2006	Exhibit RF-384
Cottier & Müller 2017	Thomas Cottier and Jörg Paul Müller, Estoppel, § 1 (April 2007), in: <i>The Max Planck Encyclopedia of Public International Law</i>	
Cowell & Andrews 1999	A. Cowell & E. L. Andrews, 'Undercurrents at a Safe Harbor; Isle of Man (and Corporations) Is an Enclave of Intrigue', <i>New York Times</i> 24 september 1999	RME-43
Crawford 2011	James Crawford, 'Introductionary Remarks', in: Graham Coop (ed.) <i>Energy Dispute Resolution: Investment Protection, Transit and the Energy Charter Treaty</i> , 2011	Exhibit RF-251
Crawford 2012	James Crawford, <i>Brownlie's Principles of Public International Law</i> , 8th ed. 2012	
Dalton 2012	R. E. Dalton, 'Provisional Application Of Treaties', in: D. B. Hollis, <i>The Oxford Guide To Treaties</i>, ed. 2012	Exhibit RF-98
Djanic 2017	V. Djanic, 'In newly unearthed Uzbekistan ruling, exorbitant fees promised to consultants on eve of tender process are viewed by tribunal as evidence of corruption, leading to dismissal of all claims under Dutch BIT', <i>Investment Arbitration Reporter</i> , 2017	Exhibit RF-360
Dmitriev 2013	Y.A. Dmitriev (red.), <i>Konstitutsiya Rossiyskoy Federatsii Doktrinalnyy kommentariy (The Constitution of the Russian Federation Doctrinal Commentary)</i> 2013	Exhibit RF-45
Van der Does de Willebois	E. van der Does de Willebois e.a., <i>The Puppet Masters. How the Corrupt Use Legal Structures to Hide Stolen Assets and What to Do About It</i> , Washington, DC: World Bank 2011.	Exhibit RF-329

UNOFFICIAL TRANSLATION

This text is an unofficial translation of the Dutch original. In case of any discrepancies, the Dutch original shall prevail.

CITATION	AUTHORITIES	EXHIBIT
Dolzer & Stevens 1995	R. Dolzer and M. Stevens, <i>Bilateral Investment Treaties 1995</i>	Exhibit RF-177
Doré 1995	J. Doré, 'The Negotiating History of the European Energy Charter Treaty', in: T.W. Wälde & K.M. Christie (red.), <i>Energy Charter Treaty: Selected Topics</i> , Dundee: University of Dundee, Centre for Petroleum and Mineral Law and Policy 1995	Exhibit RF-8
Draft Articles on Diplomatic Protection 2006	Draft Articles on Diplomatic Protection 2006 (Text adopted by the International Law Commission at its fifty-eight session, in 2006), Yearbook of the International Law Commission, 2006, vol. II, Part Two	Exhibit RF-157
Douglas 2014	Z. Douglas, 'The Secretary to the Arbitral Tribunal', in: <i>Inside the Black box: How Arbitral Tribunals Operate and Reach Their Decisions</i> , ASA Special Series 2014 No. 42	Exhibit RF-403
Eeckhout 2004	P. Eeckhout, <i>External Relations Of The European Union – Legal And Constitutional Foundations</i> , Oxford: Oxford University Press 2004	Exhibit RF-35
Energy Charter Secretariat, Staff Regulations and Rules 1995	Energy Charter Secretariat, 'Staff Regulations and Rules', in: Energy Charter Secretariat, <i>Decision of the Energy Charter Conference (CCDEC 2000 2 GEN)</i> , 2000	Exhibit RF-41
Ernste 2012	P. Ernste, <i>Bindend Advies, Serie Onderneming en Recht, deel 74, Deventer: Kluwer 2012</i>	
Fater 2010	D.H. Fater, <i>Essentials of Corporate and Capital Formation</i> , John Wiley & Sons, Inc. 2010.	Exhibit RF-331
Fawcett 1953	James Fawcett, 'The Legal Character of International Agreements', 50 BYIL 381, 1953	
Feichtner 2006	I. Feichtner, 'Waiver', in: <i>Max Planck Encyclopedia of Public International Law 2006</i>	Exhibit RF-378
Fenkner & Krasnitskaya 1999	J. Fenkner & E. Krasnitskaya, <i>Troika Dialog, How To Steal an Oil Company, in Corporate Governance in Russia: Cleaning Up the Mess</i> , 1999	RME-35
Findley, Nielson & Sharman	M.G. Findley, D.L. Nielson & J.C. Sharman, <i>Global Shell Games. Experiments in Transnational Relations, Crime, and Terrorism</i> , New York: Cambridge University Press	Exhibit RF-332
First Report By The Special Rapporteur On The Provisional Application Of Treaties 2013	First Report By The Special Rapporteur On The Provisional Application Of Treaties, Sixty-Fifth Session of the International Law Commission, A/CN.4/664, 3 juni 2013	Exhibit RF-99
Fleuren 2009	J.W.A Fleuren (e.a.), <i>Tekst & Commentaar Grondwet, Deventer: Kluwer 2009</i>	R-396
Fontaine 2013	M. Fontaine, 'L'arbitre et ses collaborateurs', <i>Revue belge de l'Arbitrage</i> , No.1, (2013)	Exhibit RF-402
Fung Fen Chung 2004	Fung Fen Chung, <i>Bewijsmiddelen in het arbitraal geding, SDU: Den Haag 2004</i>	

UNOFFICIAL TRANSLATION

This text is an unofficial translation of the Dutch original. In case of any discrepancies, the Dutch original shall prevail.

CITATION	AUTHORITIES	EXHIBIT
Gaillard & Banifatemi 2015	E. Gaillard & Y. Banifatemi, 'The Long March towards a Jurisprudence Constante on the Notion of Investment', in: M. Kinneer e.a. eds., <i>Building International Investment Law – The First 50 Years of ICSID</i> , Kluwer Law International 2015	RF-350
García Amador 1958	F.V. García Amador, 'Third Report', in: United Nations, <i>Yearbook of the International Law Commission</i> , New York 1958 (2)	R-234
Gardiner 2008	R.K. Gardiner, Treaty Interpretation, 2008	Exhibit RF-153
Gazzini 2010	T. Gazzini, 'Provisional Application of the Energy Charter Treaty: A Short Analysis of Article 45', <i>Transnational Dispute Management</i> 2010 Volume 7(1)	Exhibit RF-273
Gazzini 2015	T. Gazzini, 'Yukos Universal Limited (Isle of Man) v. The Russian Federation, Provisional Application of the ECT in the Yukos Case' <i>ICSID Review</i> , Vol. 30/2 (2015)	Exhibit RF-232
Gazzini 2016	T. Gazzini, <i>Interpretation of International Treaties</i> , Hart Publishing 2016	Exhibit RF-233
Gerbay, Richman & Scherer	R. Gerbay, L. Richman & M. Scherer, <i>Arbitrating under the 2014 LCI Rules: A User's Guide</i> , Kluwer Law International 2015	Exhibit RF-405
Giovannini 2004	T. Giovannini, 'Le Nouveau Reglement Suisse d'arbitrage international', <i>Gazette du Palais</i> , 2004, No. 2004/2	Exhibit RF-396
De Graaf 2004	K.J. de Graaf, <i>Schikken in het bestuursrecht</i> (diss.) Groningen: Bju 2004	
De Gramont & Alban 2011	A.de Gramont en E. M. Alban, 'The sun never sets: provisional application and the Energy Charter Treaty', in: Graham Coop (ed.) <i>Energy Dispute Resolution: Investment Protection, Transit and the Energy Charter Treaty</i> , 2011	Exhibit RF-291
De Groot 2012	De Groot, G., <i>Civiel deskundigenbewijs, Mon. Burgerlijk Procesrecht</i> (2012)	
Guiding Principles Applicable to Unilateral Declarations of States Capable of Creating Legal Obligations	Guiding Principles Applicable to Unilateral Declarations of States Capable of Creating Legal Obligations, with Commentaries, Principle 7, Yearbook of the International Law Commission, 2006, Vol. II, Part 2	
van Haersolte-van Hof	J.J. van Haersolte-van Hof, <i>Arbitrage op grond van Bilateral Investment Treaties</i>, WPNR 2014 (7003), 79-85)	
IBA Rules of Ethics for International Arbitrators 1987	International Bar Association, <i>Rules of Ethics for International Arbitrators</i> 1987	Exhibit RF-89
ICC Note 2012	International Council for Commercial Arbitration, <i>Note on the Appointment, Duties and Remuneration of Administrative Secretaries</i> 2012 (www.iccwbo.org)	Exhibit RF-92
ILC Commentary	ILC Commentary on Article 15, Yearbook of the	

UNOFFICIAL TRANSLATION

This text is an unofficial translation of the Dutch original. In case of any discrepancies, the Dutch original shall prevail.

CITATION	AUTHORITIES	EXHIBIT
on Article 15 2006	International Law Commission, 2006, vol. II, Part Two	
ILC Report 2006	Verenigde Naties, <i>Report of the International Law Commission</i> (Official Records, Suppl. No. 10) (A/61/10), New York 2006	Exhibit RF-84
Jacobs 1969	F.G. Jacobs, 'Varieties Of Approach To Treaty Interpretation: With Special Reference To The Draft Convention On The Law Of Treaties Before The Vienna Diplomatic Conference', 18 <i>ICLQ</i>, 1969	Exhibit RF-117
Jennings & Watts 1996	R. Jennings & A. Watts (red.), <i>Oppenheim's International Law</i> (Deel I), Londen: Longman 1996	R-256
Jessup 1948	P.C. Jessup, A Modern Law Of Nations: An Introduction, 1948	Exhibit RF-143
Joint Report 2006	Joint Report of the International Commercial Disputes Committee and the Committee of Arbitration of the New York City Bar Association, <i>The American Review of International Arbitration</i> , 2006/Vol. 17, No. 4	Exhibit RF-398
Keutgen & Dal 2006	G. Keutgen & G.A. Dal, <i>L'Arbitrage et Droit Belge et international</i> , 2006	Exhibit RF-399
Khvalei 2014	Vladimir Khvalai, 'Constitutional Grounds for Arbitration and Arbitrability of Disputes in Russia and other CIS Countries', <i>Journal of Eurasian Law</i> , 2014	Exhibit RF-269
Klabbers 1996	J. Klabbers, <i>The Concept of Treaty in International Law</i> (The Hague: Kluwer, 1996)	
Klaus 2005	U. Klaus, 'The Gate to Arbitration, The Yukos Case and the Provisional Application of the Energy Charter Treaty in the Russian Federation', <i>Transnational Dispute Management</i> 2005, Vol 2(3)	Exhibit RF-252
Komisar 2005	L. Komisar, 'Yukos Kingpin on Trial', <i>CorpWatch</i> 10 mei 2005	RME-121
Krieger 2012	H. Krieger, 'Art. 25: Provisional Application', in: O. Dörr & K. Schmalenbach (red.), <i>Vienna Convention On The Law Of Treaties: A Commentary</i> , Berlijn: Springer 2012	Exhibit RF-28
Kurochkin 2007	S.A. Kurochkin, <i>Arbitration Of Civil Law Disputes In The Russian Federation: Theory And Practice</i> , Moskou: Wolters Kluwer 2007	R-875
Lane & Seifulumukov 1999	D. Lane (red.) & I. Seifulumukov, <i>The Political Economy of Russian Oil</i> , Lanham: Rowman & Littlefield Publishers 1999	RME-21
Lefeber 1998	R. Lefeber, 'The Provisional Application Of Treaties', in: J. Klabbers & R. Lefeber (red.), <i>Essays On The Law Of Treaties: A Collection Of Essays In Honour Of Bert Vierdag</i> , Den Haag: Martinus Nijhoff Publishers 1998	Exhibit RF-27
Lefeber 2011	R. Lefeber, 'Treaties, Provisional Application', In Max Planck Encyclopedia Of Public International Law 2011	Exhibit RF-101
Lieberman & Veimetra 1996	I.W. Lieberman & R. Veimetra, 'The Rush for State Shares in the "Klondyke" of Wild West Capitalism:	RME-6

UNOFFICIAL TRANSLATION

This text is an unofficial translation of the Dutch original. In case of any discrepancies, the Dutch original shall prevail.

CITATION	AUTHORITIES	EXHIBIT
	Loans-for-Shares Transactions in Russia', <i>Geo. Washington Journal of International Law & Economics</i> 1996/737(29)	
Lokin & Zwolve 2001	J.H.A. Lokin en W.J. Zwolve, <i>Hoofdstukken uit de Europese Codificatiegeschiedenis</i> , Kluwer: Deventer 2001	
Lopez & Martinez 2017	C.M. Lopez & L. Martinez, 'Corruption, Fraud and Abuse of Process in Investment Treaty Arbitration', in: B. Legum (eds.), <i>The Investment Treaty Arbitration Review. Second Edition</i> . Law Business Research 2017	Exhibit RF-369
De Ly 2012	F.J.M. De Ly, 'Kroniek international arbitrage, TvA 2012/84	
Marres 2008	O.C.R. Marres, 'The Abuse of Law Doctrine, a Powerful Weapon Against Base Erosion', <i>Weekly Journal for Tax Law</i> 2008 (1431)	RME-1260
McNair 1961	A. McNair, <i>The Law Of Treaties</i> , Oxford: Oxford University Press 1961	RME-1001
Meerdink & Tricht 2013	E. Meerdink en R. van Tricht, 'Modernisering van het arbitraal geding', <i>TvA</i> 2013/32	
Meijer 2011	G.J. Meijer, <i>Overeenkomst tot arbitrage</i> , Deventer: Kluwer 2011	
Meijer 2014	G.J. Meijer, <i>Tekst & Commentaar Burgerlijke Rechtsvordering</i> , Deventer: Kluwer 2014	
Meijer & Van Mierlo 2014	G.J. Meijer en A.I.M. Van Mierlo, 'Aantasting van arbitrale vonnissen', <i>WPNR</i> 2014 (7003)	
Meijer 2015	Meijer et al., <i>Parlementaire Geschiedenis Arbitragewet</i>, Deventer: Kluwer 2015	
Meijer & Ernste 2015	G.J. Meijer en P.E. Ernste, 'De Arbitragewet 2015, bezien in het licht van dwingend recht en regelend recht', <i>Rechtsgeleerd Magazijn THEMIS</i> 2015-3	
Menz 2013	J. Menz, 'Miss Money Penny vs. The Fourth Musketeer: The Role of Arbitral 'Secretaries'', <i>Kluwer Arbitration Blog</i> , 9 juli 2013	Exhibit RF-401
Mertsch 2012	A.Q. Mertsch, <i>Provisionally Applied Treaties: Their Binding Force And Legal Nature</i>, 2012	Exhibit RF-121
Modderman 2015	'De Staten-Generaal en de totstandkoming van verdragen', <i>TvCR</i> 2015, p. 34-60	
De Mul 2004	Y.R.R.R. de Mul, 'De rol van de secretaris in de bouw-arbitrage', <i>Tijdschrift voor Bouwrecht</i>, 2004	
Nagapetyants 1999	R. Nagapetyants, 'Treaties for the Promotion and Reciprocal Protection of Investments', <i>Foreign Trade</i> 1999/5	Exhibit RF-50 Annex 32
Nollkaemper 2016	A. Nollkaemper, <i>Kern van het internationaal publiekrecht</i> , Bju Den Haag 2016	
Nuno Sérgio Marques Antunes 2006	Nuno Sérgio Marques Antunes, Acquiescence, § 2, in Max Planck Encyclopedia of Public International Law, available at Oxford Public International Law (http://opil.ouplaw.com)	
OECD Action Plan	OECD (2013), <i>Action Plan on Base Erosion and Profit</i>	Exhibit RF-

UNOFFICIAL TRANSLATION

This text is an unofficial translation of the Dutch original. In case of any discrepancies, the Dutch original shall prevail.

CITATION	AUTHORITIES	EXHIBIT
2013	<i>Shifting</i> , OECD Publishing. http://dx.doi.org/10.1787/9789264202719-en	77
Okunkov 1996	L.A. Okunkov (red.), <i>Commentary to Constitution of the Russian Federation (Art.-By-Art.)</i> , Moskou 1996	Exhibit RF-44
	OPEC Library, World proven crude oil reserves by country, 1980-2004	Exhibit RF-D14, bijlage MP-155
Osminin 2006	B.I. Osminin, <i>Adoption and Implementation of Treaty Obligations by States</i> , Moskou: Wolters Kluwer 2006	C-267
Park 2008	W.W. Park, 'Tax Arbitration and Investor Protection', in: G. Coop & C. Ribeiro (red.), <i>Investment Protection and the Energy Charter Treaty</i> , Huntington: JurisNet 2008	RME-3410
Partasides 2002	C. Partasides, 'The Fourth Arbitrator? The Role of Secretaries to Tribunals in International Arbitration', <i>Arbitration International</i> , 2002/18(2)	Exhibit RF-88
Paulson 2011	J. Paulsson, Denial of Justice in International Law 2011	Exhibit RF-159
Pilkov 2014	K. Pilkov, Evidence in International Arbitration: Criteria for Admission and Evaluation, Arbitration 2014	Exhibit RF-155
Polkinghorn & Gouiffes 2011	Michael Polkinghorn en Laurent Gouiffes, "Provisional application of the Energy Charter Treaty: the conundrum" in Graham Coop (ed.) <i>Energy Dispute Resolution: Investment Protection, Transit and the Energy Charter Treaty</i> , 2011	Exhibit RF-227
Poulain 2004	B. Poulain, L'investissement international: Définition ou Définitions? In: New Aspects of International Investment Law (Thomas W. Wälde and Philippe Kahn, eds. 2004)	Exhibit RF-141
Pounjin 1998	S.M. Pounjin, 'The New Federal Law On International Treaties Of The Russian Federation', in: R. Müllerson e.a. (red.), <i>Constitutional Reform And International Law In Central And Eastern Europe</i> , Londen: Kluwer Law International 1998	R-688
Pritzkow 2011	S. Pritzkow, <i>Das völkerrechtliche Verhältnis zwischen der EU und Russland im Energiesektor</i> , Springer, 2011	Exhibit RF-230
Provisional Summary Record Of The 3233e Meeting 2014	Provisional Summary Record Of The 3233e Meeting, Sixty-Sixth Session (Second Part) Of The International Law Commission, A/CN.4/SR.3233, 10 oktober 2014	Exhibit RF-109
Pryakhina 2010	T.M. Pryakhina, Constitutional Law Status Of International Treaties Of The Russian Federation That Have Not Entered Into Force, 6 Constitutional and Municipal Law, 2010	Exhibit RF-120
Quast Mertsch 2012	A. Quast Mertsch, Provisionally Applied Treaties: Their Binding Force and Legal Nature, 2012	Exhibit RF-121
Rajput 2016	A. Rajput, 'India and investment protection', in: C.L. Lim, <i>Alternative visions of the international law on</i>	Exhibit RF-337

UNOFFICIAL TRANSLATION

This text is an unofficial translation of the Dutch original. In case of any discrepancies, the Dutch original shall prevail.

CITATION	AUTHORITIES	EXHIBIT
	<i>foreign investment</i> , Cambridge University Press 2016.	
Redfern, Hunter e.a 2009	Redfern, Hunter e.a., <i>Redfern and Hunter on International Arbitration</i> , Oxford: Oxford University Press 2009	Exhibit RF-95
Reisman 2002	Michael W. Reisman, <i>Unratified Treaties And Other Unperfected Acts In International Law: Constitutional Functions</i> , 35 <i>Vanderbilt J. Transnat'l L.</i> 729 (2002), 743	R-258
Reisman & Arsanjani 2011	Michael W. Reisman, Mahnoush H. Arsanjani, <i>Provisional Application Of Treaties In International Law: The Energy Charter Awards</i> , in: <i>The Law of Treaties Beyond the Vienna Convention</i> (Enzo Cannizzaro ed. 2011)	Exhibit RF-21
Report Of The International Law Commission On The Work Of Its Sixty-Third And Sixty-Fourth Session 2013	Report Of The International Law Commission On The Work Of Its Sixty-Third And Sixty-Fourth Session, A/Cn.4/657, 18 Januari 2013	Exhibit RF-102
Report United States Government Accountability Office	US Government Accountability Office, <i>Company Formations; Minimal Ownership Information Is Collected and Available</i> , 2006	RF-334
Ripinsky & Williams 2008	S. Ripinsky & K. Williams, <i>Damages in International Investment Law</i> , Londen: British Institute of International and Comparative Law 2008	Exhibit RF-86
Ripinsky 2013	S. Ripinsky, 'Chapter 14: Russia', in: C. Brown (red.), <i>Commentaries on Selected Model Investment Treaties</i> , Oxford: Oxford University Press 2013	Exhibit RF-61
Roe & Happold 2011	T. Roe en M. Happold, <i>Settlement of Investment Disputes under the Energy Charter Treaty</i> , Cambridge 2011	Exhibit RF-253
Rules of Procedure of the Provisional Energy Charter Conference 1996	Energy Charter Secretariat, <i>Rules of Procedure of the Provisional Energy Charter Conference</i> (CC 53 Corr. 2), 1996	Exhibit RF-40
Sakwa 2009	R. Sakwa, <i>The Quality of Freedom</i> , Oxford University Press 2009.	RME-73
Sanders 2001	P. Sanders, <i>Het Nederlandse Arbitragerecht, Nationaal en Internationaal</i>, Deventer: Kluwer 2001, (4e ed)	
Sanders 2007	P. Sanders, 'De secretaris van het scheidsgerecht', <i>TvA</i> 2007/29	
Scheltema 1997	M. Scheltema, 'Toepassing in de Algemene wet bestuursrecht', in: I.C. van der Vlies & S. Pront-Van Bommel (red.), <i>Van toetsing naar bemiddeling</i> , Deventer: Kluwer 1997	
Schlemmer 2008	E.C. Schlemmer, 'Investment, Investor, Nationality, and Shareholders', in: Muchlinski, Ortino & Schreuer, eds.,	Exhibit RF-356

UNOFFICIAL TRANSLATION

This text is an unofficial translation of the Dutch original. In case of any discrepancies, the Dutch original shall prevail.

CITATION	AUTHORITIES	EXHIBIT
	<i>Oxford Handbook of International Investment Law</i> 2008	
Schwarz & Konrad 2009	F.T. Schwarz & C. Konrad, 'The Vienna Rules: A commentary on International Arbitration in Austria, Kluwer Law International 2009	Exhibit RF-400
Second Report By The Special Rapporteur On The Provisional Application Of Treaties 2014	Second Report By The Special Rapporteur On The Provisional Application Of Treaties Sixty-Sixth Session Of The International Law Commission, A/CN.4/675, 9 juni 2014	Exhibit RF-103
Sheppard 2006	A.Sheppard, <i>The Distinction between Lawful and Unlawful Expropriation, in Investment Arbitration and the Energy Charter Treaty</i> (Clarisse Ribeiro, ed., 2006)	Exhibit RF-181
Shlyantsev 2006	Commentary To The Federal Law On International Treaties Of The Russian Federation (Article-By-Article), 2006	Exhibit RF-126
Sinclair 1984	I. Sinclair, <i>The Vienna Convention On The Law Of Treaties</i> , Manchester: Manchester University Press 1984	RME-1003
Skvortsov 2005	O.Y. Skvortsov, <i>Arbitration Of Entrepreneurial Disputes In Russia. Problems. Tendencies. Perspectives</i> , Moskou: Wolters Kluwer 2005	R-190
Skvortsov 2006	O.Y. Skvortsov, 'About Certain Matters Concerning Recovery of Damages in Arbitration Proceedings', in: M. A. Rozhkova (red.), <i>Damages And Practice Of Their Recovery: Collection Of Publications</i> , Moskou: Wolters Kluwer 2006	Exhibit RF-50 Annex 27
Smakman 2007	M.P.J. Smakman, 'De rol van de secretaris van het scheidsgerecht belicht', <i>TvA</i> 2007/2	
Snijders 1995	H.J. Snijders, 'Rond de arbitrage met name in bouwzaken' in <i>Bouwarbitrage en civiele rechter, preadvies voor de Vereniging voor Bouwrecht</i>, Deventer: Kluwer 1995	Exhibit RF-197
Snijders 2011	H.J. Snijders, <i>Nederlands Arbitragerecht</i> , Deventer: Kluwer 2011	
Snijders 2011 (GS)	H.J. Snijders, 'art. 1020 Rv', in: P. Vlas & T.F.E. Tjong Tjin Tai (red.), <i>Groene Serie Burgerlijke Rechtsvordering</i> , Deventer: Kluwer (online)	
Snijders 2013	G. Snijders, '2 Korte inhoud regeling bij: Wetboek van Burgerlijke Rechtsvordering, § 4 Verwijzing en voeging van zaken', in: P. Vlas & T.F.E. Tjong Tjin Tai (red.), <i>Groene Serie Rechtsvordering</i> , Deventer: Kluwer (losbladig en online)	
Snijders 2014	H.J. Snijders, 'Openbare orde, rechtspersonen en mensenrechten', <i>NJB</i> 2014/1174	
Sondaal 1986	H.H.M. Sondaal, <i>De Nederlandse Verdragspraktijk</i> (diss.) Den Haag: T.M.C. Asser Instituut, 1986	
Stiglitz (2002)	Joseph E. Stiglitz, <i>Globalization and Its Discontents</i>	Exhibit RF-

UNOFFICIAL TRANSLATION

This text is an unofficial translation of the Dutch original. In case of any discrepancies, the Dutch original shall prevail.

CITATION	AUTHORITIES	EXHIBIT
	(2002)	303
Sukhanov 2003	E.A. Sukhanov, <i>Article By Article Commentary To The Russian Arbitration Law (Domestic) Of 2002</i> , Moskou: 2003	R-191
Thomas 2005	C. Thomas, 'Le secrétaire arbitral', <i>Revue de l'Arbitrage</i> , 2005, Issue 4	Exhibit RF-396
Thorn & Doucleff 2010	R. Thorn & J. Doucleff, <i>Disregarding the Corporate Veil and Denial of Benefits Clauses: Testing Treaty Language and the Concept of "Investor"</i> , in: M. Waibel e.a. eds., <i>The Backlash Against Investment Arbitration. Perceptions and Reality</i> , Kluwer Law International 2010	Exhibit RF-335
Thuronyi 2003	V. Thuronyi, 'Rules in OECD Countries to Prevent Avoidance of Corporate Income Tax' 2003 (http://www.mof.go.jp/english/soeken/jst2002p3.pdf)	RME-3367
Tikhomirov 1999	Yu. A. Tikhomirov, 'The Implementation of International Legal acts in the Russian Legal System', <i>Russian Law Journal</i> 1999, No. 3-4	Exhibit RF-264
Tjong Tjin Tai 2000	E. Tjong Tjin Tai, 'Verrassingsbeslissingen door de civiele rechter', <i>NJB</i> 2000	Exhibit RF-161
Tjong Tjin Tai 2008	Tjong Tjin Tai, Bewijs van de (inhoud van de) overeenkomst, <i>NJB</i> 2008/14	
Topornin 1995	B.N. Topornin, 'Russian Law And Foreign Investments: Current Problems', in: A.G. Svetlanov (red.), <i>Legal Regulation of Foreign Investments in Russia</i> , Moskou 1995	R-903
UNCITRAL Notes on Organizing Arbitral Proceedings 2012	United Nations Commission on International Trade Law, <i>UNCITRAL Notes on Organizing Arbitral Proceedings</i> , New York, 2012	Exhibit RF-91
U.S. Money Laundering Threat Assessment	Money Laundering Threat Assessment, Working Group, 2006	RF-333
Verwey 2004	D. Verwey, <i>The European Community, The European Union And The International Law Of Treaties</i>, 2004	Exhibit RF-115
Von Hombracht-Brinkman 2008	F.D. von Hombracht-Brinkman, 'Er zijn secretarissen en secretarissen! Reactie op het artikel van prof. mr. Sanders, 'De secretaris van het scheidsgerecht', <i>TvA</i> 2008/17	
Waincymer 2012	J. Waincymer, <i>Procedure and Evidence in International Arbitration</i> , Londen: Kluwer Law International 2012	Exhibit RF-87
Wälde & Sabahi 2008	T.W. Wälde and B. Sabahi, <i>Compensation, Damages and Valuation in The Oxford Handbook of International Investment Law</i> (P. Muchlinski, F. Ortino and C. Schreuer eds., 2008)	Exhibit RF-183
Weeramantry 2012	J.R. Weeramantry, <i>Treaty Interpretation in Investment Arbitration</i>, 2012	Exhibit RF-150
White & Case 2012	White & Case LLP, <i>International Arbitration Survey: Current and Preferred Practices in the Arbitral Process</i> 2012	Exhibit RF-94

UNOFFICIAL TRANSLATION

This text is an unofficial translation of the Dutch original. In case of any discrepancies, the Dutch original shall prevail.

CITATION	AUTHORITIES	EXHIBIT
WTO Panel Report of 2002	World Trade Organization, <i>United States – Countervailing Duties on Certain Corrosion-Resistant Carbon Steel Flat Products From Germany</i> (Panel Rapport) 2002	RME-1009
Yasseen 1976	M. K. Yasseen, ' <i>L'interprétation des traités d'après la Convention de Vienne sur le droit des traités</i> ' (Rec. des Cours) 1976	RME-1002
Young ICCA Guide on Arbitral Secretaries 2014	International Council for Commercial Arbitration, <i>Young ICCA Guide on Arbitral Secretaries</i> (The ICCA Reports No.1) 2014	Exhibit RF-93
Zeno 1991	T.E. Zeno, 'A Prosecutor's View of the Sentencing Guidelines', <i>55 Federal Probation</i> 31, 37, 1991	Exhibit RF-374
Zorkin (ED.) 2011	V.D. Zorkin (ED.), <i>Commentary To The Constitution Of The Russian Federation</i> (2e ed. 2011)	Exhibit RF-129

XIII. OVERVIEW OF EXPERT REPORTS AND WITNESS STATEMENTS**A. Overview of expert reports Defence on Appeal [without annexes]**

Article 45 ECT	
RF-D1	Expert Opinion of Professor Aalt Willem Heringa dated 25 July 2017.
RF-D2	Expert Opinion of Professor Dr. Georg Nolte dated 22 November 2017.
RF-D3	Expert Opinion of Professor Alain Pellet dated 10 November 2017.
RF-D4	Expert Opinion of Professor Alexei S. Avtonomov dated 6 November 2017.
RF-D5	Expert Opinion of Professor Anton V. Asoskov dated 10 November 2017.
RF-D6	Expert Opinion of Professor Sergei Yu. Marochkin dated 24 October 2017.
RF-D7	Expert Opinion of Professor Vladimir V. Yarkov dated 27 November 2017.
RF-D8	Expert Opinion of Dr. Wim A. Timmermans & Professor B. Simons dated 3 November 2017.
RF-D9	Expert Opinion of Professor H.J. Snijders dated 25 November 2017.
RF-D10	Expert Opinion of Professor Y. Nouvel dated 18 March 2016.
RF-D11	Expert Opinion of Professor K. Talus dated 18 March 2016.
RF-D12	Expert Opinion of Professor G. Nolte dated 18 March 2016.
Background	
RF-D13	Expert Opinion of Professor Dr. Dr. h.c. Mark Pieth dated 27 January 2017.
RF-D14	Expert Opinion of Professor Dr. Dr. h.c. Mark Pieth dated 10 October 2017.
RF-D15	Expert Opinion of Professor S.P. Kothari dated 26 November 2017.
Article 1(6) and 1(7) ECT	
RF-D16	Expert Opinion of Professor Alain Pellet dated 9 November 2017.
RF-D17	Expert Opinion of Andreas Michaelides dated 26 November 2017.
Damages	
RF-D18	Expert Opinion of Professor James Dow dated 28 November 2017.
RF-D19	Expert Opinion of Hermes Advisory dated 27 November 2017.
Assistant of the Tribunal	
RF-D20	Expert Opinion of Carole E. Chaski, Ph.D. dated 17 November 2017.
RF-D21	Expert Opinion I of Professor Dr. W. Daelemans dated 22 November 2017.
RF-D22	Expert Opinion II of Professor Dr. W. Daelemans dated 22 November 2017.

B. Overview of witness statements Defence on Appeal [without annexes]

Article 45 ECT	
RF-G1	Witness Statement of V.S. Katrenko 21 November 2017.
Background	
RF-G2	Witness Statement of Dmitri Gololobov dated 26 July 2016.
RF-G3	Witness Statement of Yevgeny L. Rybin dated 24 November 2017.
Article 1(6) and 1(7) ECT	
RF-G4	Witness Statement of S.A. Mikhailov dated 24 November 2017.
RF-G5	Witness Statement of Achilleas Achilleos dated 17 November 2017.

C. Overview of expert reports in First Instance and Defence on Appeal [with annexes]

WRIT	
Exhibit	Description
Article 45 ECT	
RF-50	Expert Opinion of Professor Anton V. Asoskov dated 30 October 2014
AVA1	Resolution of the Constitutional Court of the Russian Federation No. 10-P dated 26 May 2011.
AVA2	Arbitrazh Procedure Code of the Russian Federation of 1992.
AVA3	Provisional Regulation on Arbitral Tribunal for Resolving Economic Disputes, approved by Resolution of the Supreme Council of the Russian Federation No. 3115-1 dated 24 June 1992.
AVA4	Arbitrazh Procedure Code of the Russian Federation of 1995.
AVA5	Arbitrazh Procedure Code of the Russian Federation of 2002.
AVA6	Civil Procedure Code of the Russian Federation of 2002.
AVA7	S.A. Kurochkin, <i>International Commercial Arbitration and Arbitral Proceedings</i> , Moscow 2013.
AVA8	V.A. Musin & O.Yu. Skvortsov (eds.), <i>International Commercial Arbitration: Treatise</i> , St. Petersburg 2012.
AVA9	E.A. Sukhanov, <i>Civil Law: Treatise</i> , Moscow: Wolter Kluwer 2008.
AVA10	Letter of the Supreme Arbitrazh Court of the Russian Federation No. VASS06/OPP-1200 dated 23 August 2007.
AVA11	O.Yu. Skvortsov, <i>Arbitration of Entrepreneurial Disputes in Russia: Problems, Tendencies, Perspectives</i> , Moscow: Wolters Kluwer 2005.
AVA12	V.N. Anurov, 'Permissibility of Arbitration Agreement', <i>Arbitral Tribunal</i> 2005, No. 4.
AVA13	Civil Code of the Russian Federation of 1994.
AVA14	Resolution of the Presidium of the Supreme Arbitrazh Court of the Russian Federation No. 11535/13 dated January 28 2014 in the case <i>ArbatStroi vs. the State Public Health Care Institution of the City of Moscow "Industrial and Technology Association for Major Repairs and Construction of the Public Health Department of the City of Moscow"</i> .
AVA15	Resolution of the Presidium of the Supreme Arbitrazh Court of the Russian Federation No. 11059/13 in the case <i>Ministry of Natural Resources and Ecology of the Republic of Karelia vs. Forest-Group LLC</i> . dated 11 February 2014.
AVA16	Resolution of the Presidium of the Supreme Arbitrazh Court of the Russian Federation No. 3515/00 in the case <i>Property Fund of the Kaliningrad Region vs. Finvest Ltd.</i> dated 10 April 2001.
AVA17	Resolution of the Presidium of the Supreme Arbitrazh Court of the Russian Federation No. 17043/11 in the case <i>ALDEGA LLC vs. the Municipality "Town of Krasnozavodsk"</i> dated 3 April 2012.
AVA18	Federal Law No. 2118-1 "On the Fundamentals of the Tax System in the Russian Federation" dated 27 December 1991.
AVA19	Tax Code of the Russian Federation (Part one) of 1998.
AVA20	A.I. Minina, 'Objective Arbitrability in Russian Legislation, Doctrine and Arbitration Practice', <i>Relevant Issues of Russian Law</i> 2014, No. 1.

UNOFFICIAL TRANSLATION

This text is an unofficial translation of the Dutch original. In case of any discrepancies, the Dutch original shall prevail.

Exhibit	Description
AVA21	Civil Procedure Code of the Russian Soviet Federative Socialist Republic (RSFSR) of 1964.
AVA22	Federal Law No. 118-FZ "On Court Bailiffs" dated 21 July 1997.
AVA23	Federal Law No. 229-FZ "On Enforcement Proceedings" dated 2 October 2007.
AVA24	Federal Law No. 3929-1 "On Insolvency (Bankruptcy) of Business Entities" dated 19 November 1992.
AVA25	Federal Law No. 6-FZ "On Insolvency (Bankruptcy)" dated 8 January 1995.
AVA26	M.G. Rozenberg, <i>Contract of International Sale and Purchase. Contemporary Practice of Conclusion. Dispute Resolution</i> , Moscow 2007.
AVA27	O.Yu. Skvortsov, 'About Certain Matters Concerning Recovery of Damages in Arbitration Proceedings', in: M. A. Rozhkova (ed.), <i>Damages and Practice of Their Recovery: Collection of Publications</i> , Moscow 2006.
AVA28	S.I. Krupko, <i>Investment Disputes Between a State and a Foreign Investor: a Training and Practical Guide. Series "Modern legal practice"</i> , Moscow 2002.
AVA29	Fundamentals of Legislation on Foreign Investments in the USSR adopted by the Supreme Council of the USSR under No. 2302-1 dated 5 July 1991.
AVA30	Law of the RSFSR No. 1545-1 "On Foreign Investments in the RSFSR" dated 4 July 1991.
AVA31	Federal Law No. 160-FZ "On Foreign Investments in the Russian Federation" dated 9 July 1999.
AVA32	R. Nagapetyants, 'Treaties for the Promotion and Reciprocal Protection of Investments', <i>Foreign Trade</i> 1991 No. 5.
AVA33	Federal Law No. 144-FZ "On Amendments and Additions to Laws and Regulations of the Russian Federation in Connection with the Adoption of Federal Constitutional Law 'On Arbitration in the Russian Federation' and the Arbitrazh Procedure Code of the Russian Federation" dated 16 November 1997.
AVA34	S.S. Alexeev, <i>General Theory of Law: in two volumes. Vol. II</i> , Moscow 1982.
AVA35	N.I. Matuzov & A.V. Malko, <i>Theory of State and Law: Treatise</i> , Moscow 2004.
AVA36	M.N. Marchenko, <i>Issues of General Theory of State and Law: Treatise: in two volumes. Vol. 2. Law</i> , Moscow 2007.
AVA37	Federal Law No. 225-FZ "On Production-Sharing Agreements" dated 30 December 1995.
AVA38	I. Z. Farhutdinov, A.A. Danelian & M.Sh. Magomedov, 'National Regulation of Foreign Investments in Russia', <i>Zakon</i> No. 1 dated 2013.
AVA39	M.M. Boguslavsky, <i>Chapter 4</i> , in: A.S. Komarov (ed.), <i>Legal Regulation of Foreign Trade</i> , Moscow 2001.
AVA40	V.V. Silkin, <i>Direct Foreign Investments in Russia: Legal Forms of Their Attraction and Protection</i> , Moscow 2003.
AVA41	Fundamentals of Legislation on Investment Activity in the USSR, approved by Resolution of the Supreme Council of the USSR No. 1820-1 dated 10 December 1990.
AVA42	Law of the RSFSR No. 1488-1 "On Investment Activity in the RSFSR" dated 26 June 1991.

UNOFFICIAL TRANSLATION

This text is an unofficial translation of the Dutch original. In case of any discrepancies, the Dutch original shall prevail.

Exhibit	Description
AVA43	Federal Law No. 39-FZ “On Investment Activity in the Russian Federation Performed in the Form of Capital Investments” dated 25 February 1999.
AVA44	I.Z. Farkhutdinov, <i>International Investment Law and Procedure: Treatise</i> , Moscow 2014.
Damages	
RF-85	Expert Opinion of Professor James Dow dated 8 November 2014.
STATEMENT OF REPLY	
Exhibit	Description
Background	
RF-96	Expert Opinion of Reinier Kraakman dated 1 April 2011.
Assistant of the Tribunal	
RF-189	Expert Opinion of Carole E. Chaski, Ph.D. dated 11 September 2015.
CHA-1	Curriculum Vitae of Carole E. Chaski, Ph.D.
CHA-2	C.E. Chaski, 'Who Wrote It? Steps Toward a Science of Author Identification', <i>National Institute of Justice Journal</i> September 1997.
CHA-3	C.E. Chaski, 'Empirical Evaluations of Language-Based Author Identification Techniques', <i>International Journal of Speech, Language & Law</i> (8) 2001-1.
CHA-4	C.E. Chaski, 'Who's at the Keyboard? Authorship Attribution in Digital Evidence Investigations', <i>International Journal of Digital Evidence</i> , Spring (4) 2005-1.
CHA-5	C.E. Chaski, 'The Keyboard Dilemma and Author Identification', in: S. Shinoi and P. Craiger (red.), <i>Advances in Digital Forensics III</i> , New York: Springer 2007.
CHA-6	C.E. Chaski, 'Linguistics as Forensic Science: The Case of Author Identification', in: S. J. Behrens and J. A. Parker (red.), <i>Language in the Real World: An introduction to Linguistics</i> , New York: Routledge 2010.
CHA-7	C.E. Chaski, 'Author Identification in the Forensic Setting', in: L. Solan and P. Tiersma (red.), <i>The Oxford Handbook of Language and Law</i> , New York: Oxford University Press 2012.
CHA-8	C.E. Chaski, <i>Forensic Linguistics, Authorship Attribution, and Admissibility</i> , in: C. Wecht and J. Rago (red.), <i>Forensic Science and Law: Investigative Applications in Criminal, Civil and Family Justice</i> , Boca Raton: CRC Press 2005.
CHA-9	C.E. Chaski, 'Best Practices and Admissibility of Forensic Author Identification', <i>Journal of Law & Policy</i> (21) 2013-2, p. 333-376.
CHA-10	C.E. Chaski, 'Cases in the Four Corners of Forensic Linguistics', <i>Science, Technology and Law</i> , Chungbuk National University School of Law, Law Research Institute, Volume 5:1 2014.
CHA-11	J.A. Fodor & T.G. Bever, 'The Psychological Reality of Linguistic Segments', <i>Journal of Verbal Learning & Verbal Behavior</i> (4) 1965-5, pp. 414-420.
CHA-12	E.L. Battistella, <i>Markedness: The Evaluative Superstructure of Language</i> , Albany, NY: SUNY Press 1990.
CHA-13	J. Aissen, 'Markedness and Subject Choice in Optimality Theory', <i>Natural Language & Linguistic Theory</i> (17) 1999, pp. 673-711.

UNOFFICIAL TRANSLATION

This text is an unofficial translation of the Dutch original. In case of any discrepancies, the Dutch original shall prevail.

Exhibit	
CHA-14	R. A. Fisher, 'The use of multiple measurements in taxonomic problems', <i>Annals of Eugenics</i> (7) 1936-2, pp.179-188.
CHA-15	A. Woods, Paul Fletcher & Arthur Hughes, <i>Statistics in Language Studies</i> , Cambridge, UK: Cambridge University Press 1986.
CHA-16	R.H. Baayen, <i>Analyzing Linguistic Data. A Practical Introduction to Statistics Using R</i> , Cambridge, UK: Cambridge University Press 2008.
CHA-17	P. Cantos Gomez, <i>Statistical Methods in Language and Linguistic Research</i> , Sheffield, UK: Equinox Publishing Ltd. 2013.
CHA-18	C.D. Manning & H. Schutze, <i>Foundations of Statistical Natural Language Processing</i> , Cambridge, MA: MIT Press 2000.
CHA-19	I.H. Witten & E. Frank, <i>Data Mining: Practical Machine Learning Tools and Techniques</i> , New York: Morgan Kaufman 2005.
CHA-20	M.J.A. Berry & G.S. Linoff, <i>Data Mining Techniques. For Marketing, Sales, and Customer Relationship Management</i> , Indianapolis, IN: Wiley 2004.
CHA-21	M. Kantardzic, <i>Data Mining. Concepts, Models, Methods and Algorithms</i> , Piscataway, NJ: IEEE Press 2003.
ORAL PLEADINGS	
Exhibit	Description
Article 1(6) and 1(7) ECT	
RF-202	Expert Opinion of S.P. Kothari dated 20 October 2015.
R-55 (=RF-225)	Russian share register of Yukos Oil (bijlage R-55-1 t/m R-55-32).
RF-203	Expert Opinion of Professor Anton V. Asoskov dated 20 October 2015.
R-3 (=RF-225)	List of SP RTT Employees dated 1 September 1995.
R-4 (=RF-225)	Loans for Shares Auction Minutes No. 1 dated 8 December 1995.
R-5 (=RF-225)	Loans for Shares Auction Minutes No. 2 dated 8 December 1995.
R-6 (=RF-225)	ZAO Laguna Application dated 5 December 1995.
R-8 (=RF-225)	Pledge Agreement No. 0I-2-2761 dated 13 December 1995.
R-9 (=RF-225)	Stock Purchase Agreement Contract No 1-12-1-990 for Investment Competition between State Property Fund and ZAO Laguna dated 14 December 1995.
R-11 (=RF-225)	Stock Purchase Agreement L/T-1 dated 24 January 1996.
R-13 (=RF-225)	Assignment Agreement No. 198 13 December 1995.
R-14 (=RF-225)	Contract No TS-703 between Bank Menatep and ZAO Monblan for the sale and purchase of securities dated 24 December 1996.
R-24 (=RF-225)	Sale Agreement between Kincaid and Hulley dated 9 March 2000.
R-25 (=RF-225)	Sale Agreement between Temerain and Hulley dated 9 March 2000.

UNOFFICIAL TRANSLATION

This text is an unofficial translation of the Dutch original. In case of any discrepancies, the Dutch original shall prevail.

Exhibit	Description
R-26 (=RF-225)	Sale Agreement between Cayard and Hulley dated 9 March 2000.
R-27 (=RF-225)	Sale Agreement between Wandsworth and Hulley dated 9 March 2000.
R-28 (=RF-225)	Sale Agreement between Barion and Hulley dated 9 March 2000.
R-47 (=RF-225)	Report re Sale of Yukos Stock from Bank Menatep to Monblan dated 24 December 1996.
R-63 (=RF-225)	Hulley Enterprises Limited (Cyprus) v. Russian Federation, PCA Case No. AA 226, Final Award dated 18 July 2014.
R-88 (=RF-225)	Resolution No. 14828/12 in Case No. A40-82045/11 dated 26 March 2013.
R-261 (=RF-225)	Presidential Decree No. 889 dated 31 August 1995.
R-262 (=RF-225)	State Property Committee's Order No. 1458-R dated 10 October 1995.
R-263 (=RF-225)	P. Klebnikov, 'The Khodorkovsky Affair', <i>The Wall Street Journal</i> 17 November 2003.
R-264 (=RF-225)	A. Zhigulsky & J. Bernstein, 'Auctions End on Contentious Note', <i>Moscow Times</i> 29 December 1995.
R-265 (=RF-225)	Written Statement IV of Mr. Boris Berezovsky dated 31 May 2011.
R-266 (=RF-225)	Oral Testimony of Mr. Boris Berezovsky, Day 4 dated 6 October 2011.
R-267 (=RF-225)	Oral Testimony of Mr. Abramovich, Day 18 dated 2 November 2011.
R-268 (=RF-225)	Transcript, Mr. Abramovich's Attorney dated 4 October 2011.
R-269 (=RF-225)	Oral Testimony of Mr. Nevzlin, Day 15 dated 28 October 2011.
R-270 (=RF-225)	Berezovsky v. Abramovich Judgment dated 31 August 2012.
R-272 (=RF-225)	Civil Code of the Russian Federation (CCRF) dated 3 January 2006.
R-273 (=RF-225)	Resolution of the Presidium of the Supreme Commercial Court of the Russian Federation No. 17468/08 dated 14 April 2009.
R-274 (=RF-225)	Law No.1531-I On Privatization of the State and Municipal Enterprises in the Russian Federation dated 3 July 1991.
R-275 (=RF-225)	O.A. Belyaeva, 'Review of the dispute resolution practice, related to the recognition of trades void', <i>Commentaries to the Judicial Practice</i> 2006-13.
R-276 (=RF-225)	O.A. Belyaeva, "'Non-competitive trades": The Nature, Manifestations and Legal Implications', <i>Law and Economics</i> 2008, No.3.
R-277 (=RF-225)	Law No. 948-I on Competition and Limitation of Monopolistic Activity dated 22 March 1991.

UNOFFICIAL TRANSLATION

This text is an unofficial translation of the Dutch original. In case of any discrepancies, the Dutch original shall prevail.

Exhibit	Description
R-278 (=RF-225)	Ruling of the Constitutional Court of the Russian Federation No. 225-O dated 8 June 2004.
R-279 (=RF-225)	Information Letter of the Presidium of the Supreme Commercial Court of the Russian Federation No. 127 dated 25 November 2008.
R-280 (=RF-225)	Presidium of the Supreme Commercial Court, Case No. 3894/14 dated 24 June 2014.
R-281 (=RF-225)	Resolution of the Federal Commercial Court for the Northern Caucasus District No. F 08-346/2005 in the case Legal vs Seliverstov et al dated 10 March 2005.
R-282 (=RF-225)	Resolution of the Federal Commercial Court for the North Caucasus District No. F08-2633 dated August 2001.
R-283 (=RF-225)	Resolution of the Federal Commercial Court for the Moscow District No. KG-A40/3254-08 dated 27 May 2008.
R-284 (=RF-225)	Resolution of the State Duma of the Russian Federation No. 3331-II GD dated 4 December 1998.
R-285 (=RF-225)	Report of the Audit Chamber 61-62 dated 2004.
R-286 (=RF-225)	Law No. 208-FZ on Joint-Stock Companies dated 24 November 1995.
R-287 (=RF-225)	Resolution No. 16404/11 of the Supreme Commercial Court in Case No. A40-21127/11-98-184 dated 24 November 2012.
R-288 (=RF-225)	V.N. Anurov, 'Permissibility of Arbitration Agreement', <i>Arbitral Tribunal</i> 2005, No. 4 dated 2005.
R-289 (=RF-225)	Resolution No. 4G/2-12260/12 of the Moscow City Court 184 dated 25 December 2012.
R-290 (=RF-225)	Ruling of the Constitutional Court of RF No. 5-O dated 15 January 2015.
R-291 (=RF-225)	Ruling of the Constitutional Court of RF No. 233-O dated 5 February 2015.
R-292 (=RF-225)	Ruling of the Constitutional Court of RF in the matter No. 305-ES14-4115 dated 3 March 2015.
R-293 (=RF-225)	Expert Report of Professor Anton V. Asoskov, dated October 30, 2014 dated 30 October 2014.
Assistant of the Tribunal	
RF-215	Expert Opinion of Carole E. Chaski, Ph.D. dated 13 January 2016.
CHA-22	M. Rosselli et.al., 'Language Development across the Life Span: A Neuropsychological/Neuroimaging Perspective', <i>Neuroscience Journal</i> 2014.
CHA-23	M.A. Nippold et.al., 'Conversational versus expository discourse. A Study of Syntactic Development in Children, Adolescents, and Adults', <i>Journal of Speech, Language, and Hearing Research</i> (48) 2005, p. 1048-1064.
RF-224	Expert Opinion of Professor Pierre Lalive dated 16 July 2010.

UNOFFICIAL TRANSLATION

This text is an unofficial translation of the Dutch original. In case of any discrepancies, the Dutch original shall prevail.

DEFENCE ON APPEAL	
Exhibit	Description
Article 45 ECT	
RF-D1	Expert Opinion of Professor Aalt Willem Heringa dated 25 July 2017 with the Annexes on the USB stick.
HER-1	Note from the Ministry of Foreign Affairs for the DES (European Cooperation Department) dated 31 March 1994.
HER-2	Letter to the Head of the Parliamentary Affairs Section of the Ministry of Foreign Affairs dated 6 September 1994.
HER-3	Memorandum No. 122/94 of DVE/VV to DES/OB dated 22 April 1994.
HER-4	Letter from the Ministry of Foreign Affairs to the Permanent Representative at the EU Brussels (Foreign Affairs, Document no. 11.7) dated 24 November 1994.
HER-5	Statement of the Council, the Commission and the (former) Member States (Doc. 12165/94, Annex 1(December 14, 1994), 3 (R-352).
HER-6	Notice of the Ministry of Foreign Affairs to the Permanent Representative at the EU Brussels dated 8 December 1994 (Foreign Affairs, Document No. 11.4).
RF-D2	Expert Opinion of Professor Dr. Georg Nolte dated 22 November 2017 with the Annexes on the USB stick.
GN1	Curriculum Vitae of Professor Georg Nolte.
GN2	E-mail from Mr. Carsten Hoelscher (German Foreign Office, Treaty Section) to Georg Nolte dated 29 September 2017.
GN3	European Energy Charter, Compromise text for Article 50 based on Japans proposal. Conference Secretariat, Plenary Session Brussels dated 8 March 1994.
RF-D3	Expert Opinion of Professor Alain Pellet dated 10 November 2017.
RF-D4	Expert Opinion of Professor Alexei Avtonomov dated 6 November 2017 with the Annexes on the USB stick.
Annex A	Curriculum Vitae of Professor Alexei Avtonomov.
Annex B	Overview Annexes attached to the Expert Opinion of Professor Alexei Avtonomov.
ASA-001	C. Montesquieu, <i>The Spirit of Laws</i> , Book 11, Chapter 6, 1873.
ASA-002	M. Duverger, <i>Institutions Politiques et Droit Constitutionnel</i> , Vol. 1, 1975.
ASA-003	USSR Statute “on the Procedure for Concluding, Executing and Denouncing International Treaties of the USSR” dated 6 July 1978.
ASA-004	Presidium of the USSR Supreme Soviet Decree No. 4407-XI “on the Accession of the Union of Soviet Socialist Republics to the Vienna Convention on the Law of Treaties” dated 4 April 1986.
ASA-005	Draft Constitution of the Union of Soviet Republics of Europe and Asia by A.D. Sakharov dated 1989.
ASA-006	Declaration on the State Sovereignty of the Russian Soviet Federative Socialist Republic dated 12 June 1990.
ASA-007	O.G. Rummyantsev (red.), 'Table of Amendments to the Draft Constitution of the Russian Federation dated 2 September 1992', in: <i>From the History of Creation of the Constitution of the Russian Federation. Constitutional Committee: transcripts, materials, documents (1990 to 1993). Vol. 3: 1992. Book Two (July - December 1992)</i> , Moscow: Wolters Kluwer 2008.

UNOFFICIAL TRANSLATION

This text is an unofficial translation of the Dutch original. In case of any discrepancies, the Dutch original shall prevail.

Exhibit	Description
ASA-008	Yu.A. Tikhomirov, Letter to the Executive Secretary of the Constitution Committee O.G. Rumyantsev No. 01-15SB, in: O.G. Rumyantsev (eds.) <i>From the History of Creation of the Constitution of the Russian Federation. Constitutional Committee: transcripts, materials, documents (1990 to 1993). Vol. 3: 1992. Book One (January - June 1992)</i> , Moscow: Wolters Kluwer 2008.
ASA-009	Statute of the Russian Federation No. 2708-I “on Changes and Amendments to the Constitution (Main Law) of the Russian Soviet Federative Socialist Republic” dated 21 April 1992.
ASA-010	Legal Department of the Supreme Council Suggestions to amend and supplement the Constitution of the Russian Federation (State Archive Vol. No. 10026-4-1015, 1992-1993) dated October 1992.
ASA-011	Council of Nationalities of Russian Federation Supreme Council Hearing Transcript regarding Article 3 of the Russian Federation Constitution dated 2 November 1992.
ASA-012	Meeting of the Leaders of the Republics of the Russian Federation, Heads of Regional Administrations of Krays, Oblasts, Autonomous Units, the cities of Moscow and St. Petersburg Transcript dated 29 April 1993.
ASA-013	Presidential Decree No. 1400 “on Phased Constitutional Reform in the Russian Federation” dated 21 September 1993.
ASA-014	The Russian Federation Constitution dated 12 December 1993.
ASA-015	A.N. Talalaev, 'Correlation of International and National Law and the Constitution of the Russian Federation', <i>Moscow Journal of International Law</i> , 1994 No. 4.
ASA-016	State Duma Resolution No. 65-1 GD “on Announcing Political and Economic Amnesty” dated 23 February 1994.
ASA-017	Redactie Economie/Politiek, 'Kremlin is Going Through the Amnesty', <i>Kommersant</i> 1 March 1994 No. 036.
ASA-018	Transcript of State Duma International Affairs Committee Working Group Session (State Archive Vol. No. 10100-2-1205) dated 17 May 1994.
ASA-019	State Duma Hearing Transcript “on Draft Federal Statute ‘on International Treaties of the Russian Federation’” dated 27 May 1994.
ASA-020	Federal Constitutional Statute No. 1-FKZ “on the Constitutional Court of the Russian Federation” dated 21 July 1994.
ASA-021	Government of the Russian Federation Resolution No. 1390 “on the Execution of the Energy Charter Treaty and Related Documents” dated 16 December 1994.
ASA-022	Ministry of Foreign Affairs Certificate Authorizing Davydov to sign the ECT dated 16 December 1994.
ASA-023	Energy Charter Treaty (Lisbon) dated 17 December 1994.
ASA-024	State Duma Plenary Session Transcript on Draft Federal Statute “on International Treaties of the Russian Federation” dated 22 February 1995.
ASA-025	Federal Statute No. 101-FZ “on International Treaties of the Russian Federation” dated 15 July 1995.
ASA-026	Plenum of the Supreme Court Resolution No. 8 “on Certain Matters of Application of the Constitution of the Russian Federation by Courts in the Administration of Justice” dated 31 October 1995.

UNOFFICIAL TRANSLATION

This text is an unofficial translation of the Dutch original. In case of any discrepancies, the Dutch original shall prevail.

Exhibit	Description
ASA-027	B.I. Osminin & A.G. Khodakov, 'Provisional Application', in: V.P. Zvekov & B.I. Osminin (eds.) <i>Commentary on the Federal Law "On International Treaties of the Russian Federation"</i> , Moscow: SPARK 1996.
ASA-028	Constitutional Court Resolution No. 2-P in the Case on the Constitutionality of the Provisions of the Charter (Fundamental Law) of Altay Krai dated 18 January 1996.
ASA-029	Government of the Russian Federation Decree No. 1016 "on the approval and submission of the Energy Charter Treaty and the Energy Charter Protocol on Energy Efficiency and Related Environmental Aspects for ratification before the State Duma of the Federal Assembly of the Russian Federation" dated 26 August 1996.
ASA-030	Draft Federal Statute "on Ratification of the Energy Charter Treaty and the Energy Charter Protocol on Energy Efficiency and Related Environmental Aspects" dated 26 August 1996.
ASA-031	Explanatory Note to the Draft Federal Statute "on Ratification of the Energy Charter Treaty and the Energy Charter Protocol on Energy Efficiency and Related Environmental Aspects" dated 26 August 1996.
ASA-032	V. Chetvernin (red.), <i>Constitution of the Russian Federation. A Problematic Commentary</i> , Moscow 1997.
ASA-033	Explanatory Memorandum from State Duma Economic Policy Committee prepared to the Parliamentary Hearings on the ECT and the Energy Charter Protocol on Energy Efficiency and Related Environmental Aspects dated 19 February 1997.
ASA-034	State Duma Economic Policy Committee Transcript of the Parliamentary Hearing "on the Energy Charter Treaty and the Protocol to the Energy Charter Treaty on Energy Efficiency and Related Environmental Aspects" (State Archive Vol. No. 10100-14-3308, Mar.-June 1997) dated 17 June 1997.
ASA-035	State Duma Economic Policy Committee Draft Recommendations of the Parliamentary Hearing "on the Energy Charter Treaty and the Protocol to the Energy Charter Treaty on Energy Efficiency and Related Environmental Aspects" dated 17 June 1997.
ASA-036	Audit Chamber Report No. 0I-539/04 dated 24 June 1997.
ASA-037	Constitutional Court Resolution No. 4-P in the case on the verification of consistency with the Constitution of the Russian Federation of paragraphs 10, 12 and 21 of the Rules of Registration and De-Registration of the Nationals of the Russian Federation at Their Place of Stay and Residence within the Russian Federation, approved by Resolution of the Government of the Russian Federation (No. 713 dated 17 July 1995) dated 2 February 1998.
ASA-038	Constitutional Court Resolution No. 16-P "on the Inspection of the Constitutionality of paragraph 4 Article 28 of the Statute of the Komi Republic 'on State Service of the Komi Republic'" dated 29 May 1998.
ASA-039	State Duma Session No. 196 Transcript dated 31 August 1998.
ASA-040	State Duma Additional Session No. 199 Transcript dated 7 September 1998.
ASA-041	N.N. Isayev, 'On the Work with the Federal Laws Adopted by the State Duma and Dismissed by the President of the Russian Federation or the Federation Council', <i>Analytics and Statistics</i> , Autumn Session 1999.

UNOFFICIAL TRANSLATION

This text is an unofficial translation of the Dutch original. In case of any discrepancies, the Dutch original shall prevail.

Exhibit	Description
ASA-042	Constitutional Court Resolution No. 2-P “on Interpretation of Articles 71 (paragraph “d”), 76 (part 1) and 112 (part 1) of the Constitution of the Russian Federation” dated 27 January 1999.
ASA-043	Constitutional Court Resolution No. 15-P in the case on the interpretation of Article 84(b), 99(1), (2), and (4), and 109(1) of the Constitution of the Russian Federation dated 11 November 1999.
ASA-044	State Duma Transcript of the Parliamentary Hearings “on the Ratification of the Energy Charter Treaty (ECT) (Editorial Version)” dated 26 January 2001.
ASA-045	Constitutional Court Resolution No. 9-P in the case on the verification of consistency with the Constitution of Decree of the President of the Russian Federation No. 1709 dated 27 September 2000 “On Measures to Improve Governance of the State Pension Provision in the Russian Federation” in view of a request filed by a group of State Duma deputies dated 25 June 2001.
ASA-046	O. Ye. Kutafin, <i>Sources of the Constitutional Law of the Russian Federation</i> , Moscow: Jurist 2002.
ASA-047	Plenum of the Supreme Court Resolution No. 5 “on Application by Courts of General Jurisdiction of Generally Recognized Principles and Norms of International Law and International Treaties of the Russian Federation” dated 10 October 2003.
ASA-048	Presidential Decree No. 636 “on the Structure of the Federal Executive Authorities” dated 21 May 2012.
ASA-049	D.A. Shlyantsev, <i>Commentary to the Federal Law “On International Treaties of the Russian Federation” No. 101-FZ dated 15 July 1995 (Article-by-Article)</i> , Moscow: Justinform 2006.
ASA-050	B.R. Tuzmukhamedov, <i>International Law in the Constitutional Jurisdiction</i> , Moscow: Jurist 2006.
ASA-051	Federal Statute No. 69-FZ “On Ratification of the Agreement on the Eurasian Development Bank Establishment” dated 3 June 2006.
ASA-052	M.N. Marchenko, <i>Sources of Law</i> , Moscow: Prospect 2008.
ASA-053	O.G. Rummyantsev (red.), 'On the Work of the Constitution Committee (1990 to 1993)', in: <i>From the History of Creation of the Constitution of the Russian Federation. Constitutional Committee: transcripts, materials, documents (1990 to 1993). Vol. 1: 1990</i> , Moscow: Wolters Kluwer 2007.
ASA-054	Ministry of Finance Letter No. N 04-02-02/11745 “on Implementation of the Agreement between the Government of the Russian Federation and the EDB on the Conditions of Stay of the EDB in the Territory of the Russian Federation” dated 14 August 2009.
ASA-055	Message of the ECT Secretariat No. 826/09 dated 25 August 2009.
ASA-056	Letter No. 102 from the Embassy of the Russian Federation to the Republic of Portugal to the Ministry of Foreign Affairs of Portugal dated 20 August 2009.
ASA-057	Ministry of Foreign Affairs of Portugal Telefax to the Energy Charter Secretariat dated 24 August 2009.

UNOFFICIAL TRANSLATION

This text is an unofficial translation of the Dutch original. In case of any discrepancies, the Dutch original shall prevail.

Exhibit	Description
ASA-058	Letter from the Ministry of Foreign Affairs No. 6068/1DSKG “on the Application of Articles 9 and 13 of the Agreement between the Government of the Russian Federation and the Eurasian Development Bank on the Conditions of Presence of the Eurasian Development Bank in the Territory of the Russian Federation” dated 2 October 2009.
ASA-059	Letter of the Federal Tax Service No. ShS-17-3/189@ “on the Implementation of the Agreement between the Government of the Russian Federation and the Eurasian Development Bank on Conditions of Presence of the Eurasian Development Bank in the Territory of the Russian Federation” dated 21 October 2009.
ASA-060	Constitutional Court Ruling No. 1344-O-R “on explaining paragraph 5 of the operative part of Resolution of the Constitutional Court of the Russian Federation No. 3-P dated February 2, 1999 regarding the control of constitutionality of the provisions of Article 41 and of paragraph 3 of Article 42 of the RSFSR Criminal Procedure Code, and of paragraphs 1 and 2 of the Resolution of the Supreme Council of the Russian Federation dated July 16, 1993 concerning the entry into force of the Russian Federation Statute amending the RSFSR Statute “On the RSFSR Judicial System”, the RSFSR Criminal Procedure Code, the RSFSR Criminal Code, as well as the RSFSR Code of Administrative Offenses dated 19 November 2009.
ASA-061	Ruling of High Arbitrazh Court No. VAS-13594/09 Denying Assignment of Case to the Presidium of the Russian Federation Supreme Arbitrazh Court dated 7 December 2009.
ASA-062	Federal Statute No. 355-FZ “on Ratification of the Agreement between the Government of the Russian Federation and the Eurasian Development Bank on Conditions of Presence of the Eurasian Development Bank in the Territory of the Russian Federation” dated 27 December 2009.
ASA-063	Supreme Court of the Russian Federation Cassation Ruling No. 59-O09-35 dated 29 December 2009.
ASA-064	S.S. Alekseev, <i>Collected Writings in 10 Volumes. Vol. 4. The Line of the Law. A Concept. Writings for the years 1990 to 2009</i> , Moscow: Statut 2010.
ASA-065	S.S. Alekseev, <i>Collected Writings in 10 Volumes. Vol. 8. Textbooks and Learning Materials</i> , Moscow: Statut 2010.
ASA-066	B.L. Zimnenko, <i>International Law and Legal System of the Russian Federation. General Part: Course of Lectures</i> , Moscow: Statut 2010.
ASA-067	V.S. Ivanenko, 'International Treaties and the Constitution in Russian Legal System: “The War of Supremacies” or a Peaceful Interaction', <i>Jurisprudence</i> 2010 No. 3.
ASA-068	Agreement between the Government of the Russian Federation, the Government of the Republic of Belarus, and the Government of the Republic of Kazakhstan “on the Procedure of Transfer by Individuals of Goods for Personal Use Through the Customs Border of the Customs Union, and Customs Operations Related to Their Release” dated 18 June 2010.
ASA-069	S.Yu. Marochkin, <i>Operation and Implementation of the Norms of International Law Within the Legal System of the Russian Federation</i> , Moscow: NORMA INFRA-M 2011.

UNOFFICIAL TRANSLATION

This text is an unofficial translation of the Dutch original. In case of any discrepancies, the Dutch original shall prevail.

Exhibit	Description
ASA-070	A.Ya. Sliva, 'Commentary to Article 94 of the Constitution of the Russian Federation', in: V.D. Zorkin (eds.) <i>Commentary to the Constitution of the Russian Federation</i> , 2011.
ASA-071	T. Ya. Khabriyeva, 'Commentary to Article 115 of the Constitution of the Russian Federation', in: V.D. Zorkin (eds.) <i>Commentary to the Constitution of the Russian Federation</i> , 2011.
ASA-072	Federal Statute No. 60-FZ “on Ratification of the Agreement on the Procedure of Transfer by Individuals of Goods for Personal Use Through the Customs Border of the Customs Union, and Customs Operations Related to Their Release” dated 5 April 2011.
ASA-073	Agreement between the Federal Service for Environmental, Technological, and Nuclear Supervision of the Russian Federation and the Department of Technical Supervision of the Republic of Poland on the Cooperation in the Sphere of Supervision of Industrial Safety dated 10 November 2011.
ASA-074	Constitutional Court Resolution No. 8-P “on the Matter of the Constitutionality Test of Paragraph 1 of Article 23 of the Federal Statute ‘on International Treaties of the Russian Federation’ in Connection with a Complaint Filed by Citizen I.D. Ushakov” dated 27 March 2012.
ASA-075	Constitutional Court Ruling No. 476-O “on the Termination of Proceedings in the Case on the Verification of Conformity to the Constitution of the Russian Federation of Article 5(3), 23(1) and 30 of the Federal Statute ‘On International Treaties of the Russian Federation,’ under the Complaint of Mr. N.S. Karpov” dated 3 April 2012.
ASA-076	Constitutional Court of the Russian Federation Ruling No. 477-O-O “on the Termination of Proceedings in the Case on the Verification of Conformity to the Constitution of the Russian Federation of Article 5(3), 23(1) and 30 of the Federal Statute “On International Treaties of the Russian Federation”, under the Complaint of Mr. A.A. Gorodenko and Yu.Yu. Smirnova” dated 3 April 2012.
ASA-077	Constitutional Court Resolution No. 6-P “on the Verification of Conformity to the Constitution of the Russian Federation of the Treaty between the Russian Federation and the Republic of Crimea on the Accession to the Russian Federation of the Republic of Crimea and Formation of New Constituent Entities within the Russian Federation That Has Not Entered into Force” dated 19 March 2014.
ASA-078	Constitutional Court Decision No. 1820-O “on the Inadmissibility of the Complaint of Viciunai-Rus’ LLC Concerning the Violation of Its Constitutional Rights and Freedoms by the Provisions of Article 12.2(1) of the Federal Statute ‘On the Special Economic Zone in the Kaliningrad Region and Amendments to Certain Legislative Acts of the Russian Federation’” dated 18 September 2014.
ASA-079	G.V. Ignatenko, <i>International and National Law: Issues of Interference and Interrelation. A Collection of Publications of 1972-2011</i> , Moscow: NORMA INFRA-M 2012.
ASA-080	Zh.I. Ovsepyan, 'Theory of Federal Law (Common, or Simple, Ordinary Federal Laws) as a Source of Law in Russia during Globalization', <i>Constitutional and Municipal Law Review</i> 2015 No. 11.
ASA-081	The Hague District Court Judgment dated 20 April 2016.

UNOFFICIAL TRANSLATION

This text is an unofficial translation of the Dutch original. In case of any discrepancies, the Dutch original shall prevail.

Exhibit	Description
ASA-082	Cooperation Agreement between the Ministry of the Interior of the Russian Federation and the Ministry of the Interior of the Kingdom of Cambodia dated 17 May 2016.
ASA-083	S.M. Shakhrai, <i>Constitutional Law of the Russian Federation. Textbook for Undergraduate and Postgraduate Students</i> , Moscow: Statut 2017.
ASA-084	Expert report of Professor Mishina dated 8 March 2017.
ASA-085	Expert report of Professor Stephan dated 8 March 2017.
ASA-086	Statement of Vyatkin D.F. on behalf of the State Duma before the Constitutional Court dated 13 March 2012.
ASA-087	Constitution of the Italian Republic dated 27 December 1947.
ASA-088	Constitution of France dated 4 October 1958.
ASA-089	Constitution of the Kingdom of Spain dated 27 December 1978.
ASA-090	A.D. Sakharov, The Lyon Lecture dated 27 September 1989.
ASA-091	Treaty on the Establishment of Eurasian Development Bank dated 12 January 2006.
ASA-092	Agreement between the Government of the Russian Federation and the Eurasian Development Bank on the Conditions of Presence of the Eurasian Development Bank in the Territory of the Russian Federation dated 7 October 2008.
ASA-093	Letter from the Ministry of Finance to the Federal Tax Service dated 3 July 2009.
ASA-094	Letter from the Federal Tax Service to the Ministry of Finance dated 30 July 2009.
ASA-095	Letter from the Federal Tax Service to the Ministry of Foreign Affairs dated 2 September 2009.
ASA-096	Decision of the Supreme Court of the Russian Federation, Case No. 5-APU15-68 dated 8 September 2015.
ASA-097	Federal Statute No. 101-FZ "on International Treaties of the Russian Federation" amended as of 25 Dec. 2012 dated 15 July 1995.
ASA-098	State Duma Parliamentary Hearings Information Notes in <i>Analytics and Statistics: Spring Session of 1997</i> , Information Card No. 2.1.4.-PS-141 dated 17 June 1997.
ASA-099	State Duma Parliamentary Hearings Informational and Analytical Materials dated 26 January 2001.
ASA-100	V.Y. Kutsillo, 'General Prosecutor's Case' postponed indefinitely', <i>Kommersant</i> 8 April 1994 No. 063.
ASA-101	'Alexey Kazannik Cleared the Constitutional Field Up', <i>Kommersant</i> 9 April 1994 No. 064.
ASA-102	'Yeltsin Gets Into the Role of Chambellan Delaureau', <i>Kommersant</i> 12 April 1994 No. 013.
RF-D5	Expert Opinion of Professor Anton V. Asoskov dated 10 November 2017 with the Annexes on the USB stick.
Annex A	Overview Annexes attached to the Expert Opinion of Professor Anton V. Asoskov (RF-50 and RF-D5).
AVA1	Resolution of the Constitutional Court of the Russian Federation No. 10-P dated 26 May 2011.

UNOFFICIAL TRANSLATION

This text is an unofficial translation of the Dutch original. In case of any discrepancies, the Dutch original shall prevail.

Exhibit	Description
AVA2	Commercial [Arbitrazh] Procedural Code of the Russian Federation (Article 21) of 1992.
AVA3	Provisional Regulation on Arbitral Tribunal for Resolving Economic Disputes, approved by Resolution of the Supreme Council of the Russian Federation No. 3115-1 dated 24 June 1992.
AVA4	Commercial [Arbitrazh] Procedural Code of the Russian Federation of 1995.
AVA5	Commercial [Arbitrazh] Procedural Code of the Russian Federation (Article 4) of 2002.
AVA6	Civil Procedural Code of the Russian Federation (Article 3) of 2002.
AVA7	S.A. Kurochkin, <i>International Commercial Arbitration and Arbitral Proceedings</i> , Moscow 2013.
AVA8	V.A. Musin & O.Yu. Skvortsov (red.), <i>International Commercial Arbitration: Treatise</i> , St. Petersburg 2012.
AVA9	ET AL. Sukhanov, <i>Civil Law: Treatise</i> , Moscow: Wolter Kluwer 2008.
AVA10	Letter of the Supreme Arbitrazh Court of the Russian Federation No. VASS06/OPP-1200 dated 23 August 2007.
AVA11	O.Yu. Skvortsov, <i>Arbitration of Entrepreneurial Disputes in Russia: Problems, Tendencies, Perspectives</i> , Moscow: Wolters Kluwer 2005.
AVA12	V.N. Anurov, 'Permissibility of Arbitration Agreement', <i>Arbitral Tribunal</i> 2005, No. 4.
AVA13	Civil Code of the Russian Federation of 1994.
AVA14	Resolution of the Presidium of the Supreme Arbitrazh Court of the Russian Federation No. 11535/13 dated January 28, 2014 in the case <i>ArbatStroi vs. the State Public Health Care Institution of the City of Moscow "Industrial and Technology Association for Major Repairs and Construction of the Public Health Department of the City of Moscow"</i> .
AVA15	Resolution of the Presidium of the Supreme Arbitrazh Court of the Russian Federation No. 11059/13 in the case <i>Ministry of Natural Resources and Ecology of the Republic of Karelia vs. Forest-Group LLC</i> . dated 11 February 2014.
AVA16	Resolution of the Presidium of the Supreme Arbitrazh Court of the Russian Federation No. 3515/00 in the case <i>Property Fund of the Kaliningrad Region vs. Finvest Ltd.</i> dated 10 April 2001.
AVA17	Resolution of the Presidium of the Supreme Arbitrazh Court of the Russian Federation No. 17043/11 in the case <i>ALDEGA LLC vs. the Municipality "Town of Krasnozavodsk"</i> dated 3 April 2012.
AVA18	Federal Law No. 2118-1 "On the Fundamentals of the Tax System in the Russian Federation" dated 27 December 1991.
AVA19	Tax Code of the Russian Federation (Part one) of 1998.
AVA20	A.I. Minina, 'Objective Arbitrability in Russian Legislation, Doctrine and Arbitration Practice', <i>Relevant Issues of Russian Law</i> 2014, No. 1.
AVA21	Civil Procedural Code of the RSFSR (Article 428) dated 1964.
AVA22	Federal Law No. 118-FZ "On Court Bailiffs" dated 21 July 1997.
AVA23	Federal Law No. 229-FZ "On Enforcement Proceedings" dated 2 October 2007.
AVA24	Federal Law No. 3929-1 "On Insolvency (Bankruptcy) of Business Entities" dated 19 November 1992.
AVA25	Federal Law No. 6-FZ "On Insolvency (Bankruptcy)" dated 8 January 1995.
Exhibit	Description
AVA26	M.G. Rozenberg, <i>Contract of International Sale and Purchase. Contemporary Practice of Conclusion. Dispute Resolution</i> , Moscow 2007.

UNOFFICIAL TRANSLATION

This text is an unofficial translation of the Dutch original. In case of any discrepancies, the Dutch original shall prevail.

AVA27	O.Yu. Skvortsov, 'About Certain Matters Concerning Recovery of Damages in Arbitration Proceedings', in: M. A. Rozhkova (ed.), <i>Damages and Practice of Their Recovery: Collection of Publications</i> , Moscow 2006.
AVA28	S.I. Krupko, <i>Investment Disputes Between a State and a Foreign Investor: a Training and Practical Guide. Series "Modern legal practice"</i> , Moscow 2002.
AVA29	Fundamentals of Legislation on Foreign Investments in the USSR adopted by the Supreme Council of the USSR under No. 2302-1 dated 5 July 1991.
AVA30	Law of the RSFSR No. 1545-1 "On Foreign Investments in the RSFSR" dated 4 July 1991.
AVA31	Federal Law No. 160-FZ "On Foreign Investments in the Russian Federation" dated 9 July 1999.
AVA32	R. Nagapetyants, 'Treaties for the Promotion and Reciprocal Protection of Investments', <i>Foreign Trade</i> 1991 No. 5.
AVA33	Federal Law No. 144-FZ "On Amendments and Additions to Laws and Regulations of the Russian Federation in Connection with the Adoption of Federal Constitutional Law 'On Arbitration in the Russian Federation' and the Arbitrazh Procedure Code of the Russian Federation" dated 16 November 1997.
AVA34	S.S. Alexeev, <i>General Theory of Law: in two volumes. Vol. II</i> , Moscow 1982.
AVA35	N.I. Matuzov & A.V. Malko, <i>Theory of State and Law: Treatise</i> , Moscow 2004.
AVA36	M.N. Marchenko, <i>Issues of General Theory of State and Law: Treatise: in two volumes. Vol. 2. Law</i> , Moscow 2007.
AVA37	Federal Law No. 225-FZ "On Production-Sharing Agreements" dated 30 December 1995.
AVA38	I. Z. Farhutdinov, A.A. Danelian & M.Sh. Magomedov, 'National Regulation of Foreign Investments in Russia', <i>Zakon</i> No. 1 dated 2013.
AVA39	M.M. Boguslavsky, <i>Chapter 4</i> , in: A.S. Komarov (ed.), <i>Legal Regulation of Foreign Trade</i> , Moscow 2001.
AVA40	V.V. Silkin, <i>Direct Foreign Investments in Russia: Legal Forms of Their Attraction and Protection</i> , Moscow 2003.
AVA41	Fundamentals of Legislation on Investment Activity in the USSR, approved by Resolution of the Supreme Council of the USSR No. 1820-1 dated 10 December 1990.
AVA42	Law of the RSFSR No. 1488-1 "On Investment Activity in the RSFSR" dated 26 June 1991.
AVA43	Federal Law No. 39-FZ "On Investment Activity in the Russian Federation Performed in the Form of Capital Investments" dated 25 February 1999.
AVA44	I.Z. Farkhutdinov, <i>International Investment Law and Procedure: Treatise</i> , Moscow 2014.
AVA45	Charter of the United Nations (San Francisco) dated 26 June 1945.
AVA46	Civil Procedural Code of the RSFSR (Article 282) dated 1964.
AVA47	UN General Assembly Resolution No. A / RES / 25/2625 dated 24 October 1970.

UNOFFICIAL TRANSLATION

This text is an unofficial translation of the Dutch original. In case of any discrepancies, the Dutch original shall prevail.

Exhibit	Description
AVA48	Decree of the Supreme Council of the USSR (the Soviet Parliament) No. 1511-I dated 23 May 1990.
AVA49	Resolution of the Supreme Council of the USSR (the Soviet Parliament) No. 2202-1 dated 29 May 1991.
AVA50	Resolution of the Supreme Council of the USSR (the Soviet Parliament) No. 2205-1 dated 29 May 1991.
AVA51	I.O. Khlestova, 'Legislation and International Treaties on Protection of Foreign Investments', <i>Moscow Journal of International Law</i> 1992 No. 2.
AVA52	N.N.Voznesenskaya, Regulation of Foreign Investments in Russia, <i>The Law</i> 1992 No. 8.
AVA53	Regulation No. 395 of the Government of the Russian Federation "On the Conclusion of Agreements Between the Government of the Russian Federation and Foreign Governments on the Promotion and Reciprocal Protection of Investments" dated 11 June 1992.
AVA54	M.M. Boguslavsky & L.N. Orlov, <i>Russian Legislation on Joint Ventures. A Commentary</i> , Moscow 1993.
AVA55	S.I. Dolgov & V.V. Perskaya, <i>Investment Cooperation in the Territory of Russia. Economy, Legal Support, Organization Technique</i> , Moscow 1993.
AVA56	N.G. Doronina & N.G. Semilutina, <i>Legal Regulation of Foreign Investments in Russia and Abroad</i> , Moscow 1993.
AVA57	Law of the Russian Federation No. 5338-1 "On International Commercial Arbitration" dated 7 July 1993.
AVA58	Constitution of the Russian Federation (Article 15(4)) dated 12 December 1993.
AVA59	Agreement Between the Organization for Economic Co-Operation and Development and the Government of the Russian Federation on Privileges and Immunities Granted to the Organization in the Russian Federation (Paris) dated 8 June 1994.
AVA60	Air Services Agreement between the Government of the Russian Federation and the Government of Australia (Moscow) dated 11 July 1994.
AVA61	Energy Charter Treaty dated 17 December 1994.
AVA62	Federal Law No. 76-FZ "On the State's Foreign Borrowings of the Russian Federation and the State's Loans issued by the Russian Federation to foreign States, their legal entities and international organizations" dated 26 December 1994.
AVA63	N.G. Doronina & N.G. Semilutina, 'The Investment Disputes Settlement Procedure', <i>Legislation and Economy</i> 1995. No. 7/8.
AVA64	Federal Law No. 101-FZ "On International Treaties of the Russian Federation" dated 15 July 1995.
AVA65	Resolution of Plenum of the Supreme Court of the Russian Federation No.8 "On Certain Issues of Application of the Constitution of the Russian Federation by Courts in the Administration of Justice" dated 31 October 1995.
AVA66	N.G. Doronina, <i>Legal Regulation of Foreign Investments. Articulation of Problems and Alternate Solutions</i> (diss. Moscow), Moscow: The Institute of Legislation and Comparative Law under the Government of the Russian Federation 1996.

UNOFFICIAL TRANSLATION

This text is an unofficial translation of the Dutch original. In case of any discrepancies, the Dutch original shall prevail.

Exhibit	Description
AVA67	The Explanatory Note to the Draft Federal Law “On Ratification of the Energy Charter Treaty and the Energy Charter Protocol on Energy Efficiency and Related Environmental Aspects dated 26 August 1996.
AVA68	S.A. Sosna, 'What should the law on foreign investment be in Russia?', <i>Legislation and Economy</i> 1997. No. 13/14.
AVA69	Federal Law No. 119-FZ “On Enforcement Proceedings” dated 21 July 1997.
AVA70	Federal Law 54-FZ dated 30 March 1998.
AVA71	Yu.A. Tikhomirov, 'Implementation of international legal acts in the Russian legal system', <i>The Russian Law Journal</i> 1999 No. 3-4.
AVA72	Federal Law No. 192-FZ dated 25 October 1999.
AVA73	Explanatory Note “On Ratification of the Agreement Between the Government of the Russian Federation and the Government of the Argentine Republic on Promotion and Reciprocal Protection of Investments” dated 25 October 1999.
AVA74	A. Konoplyanik, <i>Energy Charter Treaty: Way to Investments and Trade for East and West</i> , Moscow: International Relationships 2002, p.34.
AVA75	Commercial [Arbitrazh] Procedural Code of the Russian Federation (Arts. 3, 198) dated 24 July 2002.
AVA76	Federal Law No.127-FZ “On Insolvency (Bankruptcy)” (Article 33(3)) dated 26 October 2002.
AVA77	Civil Procedural Code of the Russian Federation (Article 1) dated 14 November 2002.
AVA78	V.M. Sherstyuk, 'Grondbeginselen', in: V.M. Zhuikov, V.K. Puchinskiy & M.K. Treushnikov (red.), <i>Scientific Practical Commentary to the Civil Procedural Code of the Russian Federation</i> , Moscow: : OAO 'Izdatelskiy Dom 'Gorodez' 2003.
AVA79	Resolution of Plenum of the Supreme Court of the Russian Federation No.5 “On Application by Courts of General Jurisdiction of Generally Recognized Principles and Norms of International Law and International Treaties and Agreements of the Russian Federation” dated 10 October 2003.
AVA80	Resolution of the Constitutional Court of the Russian Federation No. 7-P dated 6 April 2004.
AVA81	Explanatory Note “On Ratification of the Agreement between the Government of the Russian Federation and the Government of the Republic of Lithuania on Promotion and Reciprocal Protection of Investments” dated 26 April 2004.
AVA82	Federal Law No. 30-FZ dated 26 April 2004.
AVA83	Resolution of the Constitutional Court of the Russian Federation No. 6-P dated 31 May 2005.
AVA84	Federal Law No. 79-FZ dated 2 July 2005.
AVA85	Federal Law No. 167-FZ dated 20 December 2005.
AVA86	G.V. Sevastyanov, 'Commentary. Section I. Article I', in: A.S. Komarov, S.N. Lebedev & V.A. Musin (red.), <i>Commentary on the Law of the Russian Federation “On International Commercial Arbitration”. An article-by-article, scientific practical commentary</i> , St. Petersburg 2007.
AVA87	Federal Law No. 122-FZ dated 30 June 2007.
AVA88	A.L. Makovskiy, 'Codification of the Civil Code and Development of National-International Private Law', in: D.A. Medvedev (ed.), <i>Codification of Russian Private Law</i> , Moscow 2008.
Exhibit	Description
AVA89	Resolution of the Federal Commercial Court for the North Caucasus Circuit in Case No. A53-7504/2008-C4-10 OOO <i>Russkiy Tranzit v. the Rostov Customs</i> dated 18

UNOFFICIAL TRANSLATION

This text is an unofficial translation of the Dutch original. In case of any discrepancies, the Dutch original shall prevail.

	March 2009.
AVA90	Resolution of the Federal Commercial Court for the North-Western Circuit in Case No. A52-5378/2008 OOO <i>Arnold Reisebusse v. the Pskov Customs</i> dated 10 August 2009.
AVA91	Resolution of the Ninth Commercial Court of Appeal dated 7 September 2009.
AVA92	Resolution of the Federal Commercial Court for the Moscow Circuit No. KG-A40/12036-09 in the Case of the Moscow City Property Department (Case No. A40-47723/09-84-216) dated 26 November 2009.
AVA93	V.V. Yarkov (ed.), <i>Commentary on the Commercial [Arbitrazh] Procedural Code of the Russian Federation (article-by-article)</i> , Moscow: Infotropik Media 2011.
AVA94	Nersesyants V.S. <i>General Theory of the Law and the State: Textbook</i> . Moscow, 2012.
AVA95	P.V. Krasheninnikov, O.A. Ruzakova & G.A. Slavinskaya, 'Commentary on the Civil Procedural Code of the Russian Federation', <i>Bulletin of the Civil Process</i> 2014.
AVA96	Ruling of the Constitutional Court of the Russian Federation No. 2531-O dated 6 November 2014.
AVA97	Ruling of the Constitutional Court of the Russian Federation No. 5-O dated 15 January 2015.
AVA98	Ruling of the Supreme Court of the Russian Federation No. 301-ES17-2749 in Case No. A82-13743 / 2015 <i>Turborus v. Zorya-Mashproekt</i> dated 14 April 2017.
AVA99	Ruling of the Supreme Court of the Russian Federation No. 305-KG17-13231 in Case No. A40-178819 / 2016 <i>Arsenal v. Moscow Customs</i> dated 29 September 2017.
RF-D6	Expert Opinion of Professor Sergei Yu. Marochkin dated 24 October 2017 with the Annexes on the USB stick.
Annex A	Curriculum Vitae of Professor Sergei Yu. Marochkin
SYM-01	A.S. Pigolkin, <i>Interpretation of Statutory Acts in the USSR</i> , Moscow: State Publishing House for Legal Literature 1962.
SYM-02	Vienna Convention on the Law of Treaties, <i>United Nations Treaty Series</i> Vol. 1155, No. 18232, Concluded at Vienna dated 23 May 1969, entered into force dated 27 January 1980.
SYM-03	Statute "on the Procedure of Conclusion, Implementation, and Denunciation of International Treaties of the USSR" dated 6 July 1978.
SYM-04	Presidium of the Supreme Soviet of the USSR Decree No. 4407-XI "on the Accession of the Union of Soviet Socialist Republics to the Vienna Convention on the Law of Treaties" dated 4 April 1986.
SYM-05	Draft Statute on Foreign Investments (State Archive Vol. No. 10026-4-2622, 1990-1991), Article 61.
SYM-06	Draft Statute on Foreign Investments (State Archive Vol. No. 10026-4-2622, 1990-1991), Article 68.

UNOFFICIAL TRANSLATION

This text is an unofficial translation of the Dutch original. In case of any discrepancies, the Dutch original shall prevail.

Exhibit	Description
SYM-07	Draft Statute on Foreign Investments (State Archive Vol. No. 10026-4-2622, 1990-1991), Article 9.
SYM-08	Conclusions by Ms. N. Marysheva on the Draft Statute on Foreign Investments of RSFSR (State Archive Vol. No. 10026-4-2624, 27 Nov. 1990-26 Dec. 1991).
SYM-09	Comments of Institutions, Banks, and Law Firms on the Draft Statute on Foreign Investments (State Archive Vol. No. 10026-4-2624, 27 Nov. 1990-26 Dec. 1991).
SYM-10	Agreement Establishing the Commonwealth of Independent States, Article 12, Minsk dated 8 December 1991, entered into force for the Russian Federation on 12 December 1991.
SYM-11	S. Tsyplakov, 'Listing a Russian Law', <i>The Stock Exchange Journal</i> [Биржевые Ведомости], 1991, No. 3.
SYM-12	Statute No. 1545-1 "on Foreign Investments in the RSFSR", Article 9, dated 4 July 1991.
SYM-13	S. Tsyplakov, Draft Article (State Archive Vol. No. 10026-4-2624, 27 Nov. 1990-26 Dec. 1991).
SYM-14	Comments by R.M. Tsyvilev to the Draft Statute "on International Treaties of the Russian Federation" (State Archive Vol. No. 10026-4-1228, 16 Feb. 1992-22 June 1993) dated 3 February 1993.
SYM-15	Energy Charter Treaty, Lisbon dated 17 December 1994.
SYM-16	Statute No. 101-Fz "on International Treaties of the Russian Federation" dated 15 July 1995.
SYM-17	Statute No. 160-FZ "on Foreign Investments in the Russian Federation" dated 9 July 1999.
SYM-18	A.P. Sergeev & Yu. K. Tolstoy, <i>Civil Law</i> , Moscow: Prospekt 2000.
SYM-19	N.I. Matuzov & A.V. Malko, <i>Theory of State and Law. Manual</i> , Moscow: Jurist 2004.
SYM-20	B.L. Zimnenko, <i>International Law and Legal Systems of the Russian Federation. General Part: Course of Lectures</i> , Moscow: Statut, 2010.
SYM-21	United Nations, <i>Treaty Handbook</i> , 2012.
SYM-22	I.Z. Farhutdinov, A.A. Danelian & M.Sh. Magomedov, 'National Regulation of Foreign Investments in Russia', <i>Zakon</i> , 2013. No. 1.
SYM-23	Expert Report of Professor Asoskov dated 30 October 2014.
SYM-24	Expert Report of Professor Asoskov dated 15 June 2015.
SYM-25	The Hague District Court Judgment dated 20 April 2016.
SYM-26	Expert Report of Professor Stephan dated 8 March 2017.
SYM-27	Decision of the Supreme Court of the Russian Federation, Case No. 5-APU15-68 dated 8 September 2015.
SYM-28	Fourth Additional Protocol to the European Convention on Extradition, CETS No. 212, Vienna dated 20 September 2012.
RF-D7	Expert Opinion of Professor Vladimir V. Yarkov dated 27 November 2017 with the Annexes on the USB stick.
Annex A	Curriculum Vitae of Professor Vladimir V. Yarkov.
Annex B	Overview Annexes attached to the Expert Opinion of Professor Vladimir V. Yarkov.

UNOFFICIAL TRANSLATION

This text is an unofficial translation of the Dutch original. In case of any discrepancies, the Dutch original shall prevail.

Exhibit	Descriptionen
VVY-01	RSFSR Statute “on Investment Activity in RSFSR” dated 26 June 1991.
VVY-02	Statute of the Russian Federation No. 1545-1 “on Foreign Investments in the RSFSR” dated 4 July 1991.
VVY-03	Civil Code of the Russian Federation (Part One) dated 30 November 1994.
VVY-04	Federal Statute No. 160-FZ “on Foreign Investments in the Russian Federation” dated 9 July 1999.
VVY-05	Commercial [Arbitrazh] Procedure Code dated 24 July 2002.
VVY-06	Civil Procedure Code of the Russian Federation dated 14 November 2002.
VVY-07	Resolution of the Federal Commercial Court of Moscow Circuit in Case No. KA-A41/8778-03 dated 14 November 2003.
VVY-08	Housing Code of the Russian Federation dated 29 December 2004.
VVY-09	<i>Hulley Enterprises Limited v. The Russian Federation</i> , UNCITRAL, Notice of Arbitration and Statement of Claim dated 3 February 2005.
VVY-10	<i>Yukos Universal Limited v. The Russian Federation</i> , UNCITRAL, Notice of Arbitration and Statement of Claim dated 3 February 2005.
VVY-11	<i>Veteran Petroleum Limited v. The Russian Federation</i> , UNCITRAL, Notice of Arbitration and Statement of Claim dated 14 February 2005.
VVY-12	Eighth Federal Commercial [Arbitrazh] Appellate Court Decision No. 08AP-2538/2008 re Case No. 46-8190/2007 dated 23 July 2008.
VVY-13	<i>Hulley Enterprises Limited (Cyprus) v. The Russian Federation</i> , PCA Case No. AA 226, Interim Award on Jurisdiction and Admissibility dated 30 November 2009.
VVY-14	<i>Veteran Petroleum Limited (Cyprus) v. The Russian Federation</i> , PCA Case No. AA 228, Interim Award on Jurisdiction and Admissibility dated 30 November 2009.
VVY-15	<i>Yukos Universal Limited (Isle of Man) v. The Russian Federation</i> , PCA Case No. AA 227, Interim Award on Jurisdiction and Admissibility dated 30 November 2009.
VVY-16	<i>Hulley Enterprises Limited (Cyprus) v. The Russian Federation</i> , PCA Case No. AA 226, Final Award dated 18 July 2014.
VVY-17	<i>Veteran Petroleum Limited (Cyprus) v. The Russian Federation</i> , PCA Case No. AA 228, Final Award dated 18 July 2014.
VVY-18	<i>Yukos Universal Limited (Isle of Man) v. The Russian Federation</i> , PCA Case No. AA 227, Final Award dated 18 July 2014.
VVY-19	Administrative Procedure Code of the Russian Federation dated 8 March 2015.
VVY-20	Commercial [Arbitrazh] Court of Western-Siberian Circuit Decision No. F04-17490/15 re Case No. A45-12828/2014 dated 20 April 2015.
VVY-21	Fourteenth Commercial [Arbitrazh] Appellate Court Decision No. 14AP-4477/15 re Case No. A13-5850/2014 dated 3 November 2015.
VVY-22	Hague District Court Judgment dated 20 April 2016.
VVY-23	Seventh Commercial [Arbitrazh] Appellate Court Decision No. 07AP-5424/16 re Case No. A45-20887/2015 dated 15 July 2016.
VVY-24	Resolution of Fifteenth Commercial [Arbitrazh] Appellate Court No. 15AP-5638/17 dated 22 May 2017.
VVY-25	Expert Report of Professor Sergey Y. Marochkin dated 24 October 2017.

UNOFFICIAL TRANSLATION

This text is an unofficial translation of the Dutch original. In case of any discrepancies, the Dutch original shall prevail.

Exhibit	Description
VVY-26	Expert Report of Professor Alexei S. Avtonomov dated 6 November 2017.
VVY-27	Expert Report of Professor Anton V. Asoskov dated 10 November 2017.
RF-D8	Expert Opinion of Dr. Wim A. Timmermans and Professor William B. Simons dated 3 November 2017.
RF-D9	Expert Opinion of Professor H.J. Snijders dated 25 November 2017.
RF-D10	Expert Opinion of Professor Y. Nouvel dated 18 March 2016.
RF-D11	Expert Opinion of Professor K. Talus dated 18 March 2016
RF-D12	Expert Opinion of Professor G. Nolte dated 18 March 2016
Background	
RF-D13	Expert Opinion of Professor Dr. Dr. h.c. Mark Pieth dated 27 January 2017.
Annex A	Curriculum Vitae of Professor Dr. Dr. h.c. Mark Pieth.
Annex B	Overview Annexes attached to the Expert Opinion of Professor Dr. Dr. h.c. Mark Pieth dated 27 January 2017.
Annex C	Charts of Service Agreements with Status Services Ltd. and Hinchley Ltd.
MP-001	B. Cheng, <i>General Principles of Law as Applied by International Courts and Tribunals</i> , London: Stevens & Sons 1953.
MP-002	G.P. Tikhonova & A.A. Bolshakov, Commentary on the 1960 Criminal Code of the RSFSR, 1962.
MP-003	B.S. Nikiforov, <i>Scientific Applied Commentary on the Criminal Code of the RSFSR</i> , 1963, pp.364-381.
MP-004	Omnibus Crime Control and Safe Streets Act of 1968, Public Law No. 90-351 dated 1968.
MP-005	ICC Case No. 3916 of 1982, <i>Journal du Droit International</i> (4)1984, p. 507.
MP-006	Plenum of the USSR Supreme Court, Resolution No. 4 dated 30 March 1990.
MP-007	Presidential Decree No. 1403 dated 17 November 1992.
MP-008	Council of Ministers Resolution No. 383-p dated 6 March 1993.
MP-009	Council of Ministers Resolution No. 354 dated 15 April 1993.
MP-010	ICC Case No. 6497.
MP-011	Protocol No. 3 of the YUKOS Board of Directors dated 27 May 1994.
MP-012	Regulation on Investment Tenders for the Sale of Shares of YUKOS Oil Company, attached to Letter No. 10/112 dated 19 June 1995, dated 15 December 1994.
MP-013	Presidential Decree No. 889 on the Procedure for Putting the Federally Owned Shares in Pledge dated 31 August 1995.
MP-014	List of RTT Employees dated 1 September 1995.
MP-015	Letter from S.V. Muravlenko to A.B. Chubais dated 27 September 1995.
MP-016	State Property Committee Order No. 1458, amended 31 Oct. 1995 dated 10 October 1995.
MP-017	Investment Program, approved by Decision of the Board of YUKOS Oil Company, Minutes No. 13 dated 12 October 1995.
MP-018	Memorandum from A.D. Golubovich to M.D. Khodorkovsky dated 2 November 1995.
MP-019	Auction Minutes No. 1 dated 8 December 1995.
MP-020	Auction Minutes No. 2 dated 8 December 1995.

UNOFFICIAL TRANSLATION

This text is an unofficial translation of the Dutch original. In case of any discrepancies, the Dutch original shall prevail.

Exhibit	Description
MP-021	Assignment Agreement N. 198 between Laguna CJSC and Bank Menatep dated 13 December 1995.
MP-022	Contract No. 2-11-2/981 between Bank Menatep and Russian Fund of Federal Property dated 13 December 1995.
MP-023	Stock Purchase Agreement No. 1-12-1-990 dated 14 December 1995.
MP-024	Investment Agreement between Mr. Muravlenko and Mr. Zakharov dated 1996.
MP-025	Schedule of Auction Events dated 1996.
MP-026	Chart of Shell Companies dated 1996.
MP-027	List Identifying OAO Moscow Food Factory as Menatep Group Company.
MP-028	Services Agreement between Tisbury Limited and V.V. Ivanenko dated 5 January 1996.
MP-029	Stock Purchase Agreement No. L/A-1 dated 24 January 1996.
MP-030	Stock Purchase Agreement No. L/T-1 dated 24 January 1996.
MP-031	Receipt of Payment from Tisbury Limited dated 15 April 1996.
MP-032	Criminal Code of the Russian Federation No. 63-Fz dated 13 June 1996.
MP-033	List of Members of the Board of Directors of Bank Menatep dated 1 November 1996.
MP-034	Report on the Sale of a Lot of Shares of Open Joint Stock Company YUKOS Oil Company dated 24 December 1996.
MP-035	S. Lukyanov, "Managed' Yukos Sale Fetches \$160M", <i>Moscow Times</i> 24 December 1996.
MP-036	Securities Purchase-Sales Agreement No. Ts-703 dated 24 December 1996.
MP-037	<i>United States v. Ellis</i> , 121 F.3d 908, 922 (4th Cir. 1997).
MP-038	GML Registration Documents 1997 - 2004.
MP-039	YUL Registration Documents 1997 - 2004.
MP-040	Stock Purchase Agreement No. U-51/97 dated 5 May 1997.
MP-041	Stock Purchase Agreement No. U-52/97 between Monblan and Yukos-Trust dated 5 May 1997.
MP-042	Registration of Status Services Limited dated 13 November 1997.
MP-043	RTT Revised JV Charter dated 8 December 1997.
MP-044	ICC Case No. 8891, J.J. Arnaldez, Y. Derains & D. Hascher, Collection of ICC Arbitral Awards 1996-2000, 2003, p. 561, Final Award dated 1998.
MP-045	Services Agreement between Laleham Limited and V.V. Ivanenko dated 12 January 1998.
MP-046	Receipt of Payment from Laleham Limited dated 28 April 1998.
MP-047	Services Agreement between Status Services Limited and V.A. Kazakov dated 7 May 1998.
MP-048	Receipt of Payment from Status Services Limited dated 11 August 1998.
MP-049	Services Agreement between Hinchley Limited and S.V. Muravlenko dated 1 October 1998.
MP-050	Survey of Court Practice of the Supreme Court of the Russian Federation for the Third Quarter of 1998 Regarding Criminal Cases, approved by Resolution of the Presidium of the Supreme Court of the Russian Federation dated 2 December 1998.

UNOFFICIAL TRANSLATION

This text is an unofficial translation of the Dutch original. In case of any discrepancies, the Dutch original shall prevail.

Exhibit	Description
MP-051	Receipt of Payment from Hinchley Limited dated 7 December 1998.
MP-052	Certificate of Fulfilment of the Activities of YUKOS Oil Company OJSC's Investment Program in Accordance with the Conditions of the Pledge Auction dated 16 December 1998.
MP-053	Council of Europe Civil Law Convention on Corruption dated 1999.
MP-054	Council of Europe Criminal Law Convention on Corruption dated 1999.
MP-055	2000 YUKOS Annual Report.
MP-056	Letter from Iain Gardiner to Isle of Man Financial Supervision Commission Chief Registrar (Hinchley) dated 9 November 2000.
MP-057	Letter from Iain Gardiner to Isle of Man Financial Supervision Commission Chief Registrar (Laleham) dated 9 November 2000.
MP-058	2001 YUKOS Annual Report.
MP-059	BVI Financial Services Commission Registry of Corporate Affairs, Report for Tempo Finance Ltd. Registration dated 14 March 2001.
MP-060	Email from Stephen Curtis & James Jacobson to Anton Drel dated 12 April 2001.
MP-061	Fax from Nicholas Keeling to Anton Drel cc James Jacobsen dated 1 June 2001.
MP-062	Letter from Iain Gardiner to Isle of Man Financial Supervision Commission Chief Registrar dated 12 June 2001.
MP-063	Fax from Victor Prokofiev to Stephen Curtis dated 11 July 2001.
MP-064	2002 YUKOS Annual Report.
MP-065	J.E. Stiglitz, <i>Globalization and its Discontents</i> , W.W. Norton & Company: New York, NY 2002 p.58.
MP-066	Bank Statements of Yukos Universal Limited 2002-2003.
MP-067	Original Agreement between Group Menatep Limited, Beneficiaries, and Tempo Finance Ltd. dated 26 March 2002.
MP-068	Schedule of Payments to Original Agreement between Group Menatep Limited, Beneficiaries, and Tempo Finance Ltd. dated 26 March 2002.
MP-069	Email from Michael Tamaev to Bruce Bean dated 12 August 2002.
MP-070	Memorandum from Clifford Chance on Privatisation of YUKOS dated 12 August 2002.
MP-071	Memorandum from Doug Miller to Bruce Misamore dated 14 August 2002.
MP-072	Email from Bruce Bean dated 15 August 2002.
MP-073	Letter from Anton V. Drel to Doug Miller dated 27 August 2002.
MP-074	Clifford Chance Email dated 30 September 2002.
MP-075	Amended and Restated Compensation Agreement between Group Menatep Limited, Beneficiaries, and Tempo Finance Ltd. dated 1 November 2002.
MP-076	Email from Bruce Misamore to Dmitry Gololobov dated 27 November 2002.
MP-077	African Union Convention on Preventing and Combating Corruption dated 2003.
MP-078	Draft F-1 Registration Statement dated 19 March 2003.
MP-079	Email from Doug Miller dated 29 April 2003.
MP-080	YUKOS Consolidated Financial Statements dated September 2003.

UNOFFICIAL TRANSLATION

This text is an unofficial translation of the Dutch original. In case of any discrepancies, the Dutch original shall prevail.

Exhibit	Description
MP-081	UN Convention Against Corruption dated 2004.
MP-082	Y. Luo, 'An Organizational Perspective of Corruption', <i>Management and Organization Review</i> January 2004, p.119.
MP-083	Government of Isle of Man Disqualification Orders dated 19 November 2004.
MP-084	U.S. Money Laundering Threat Assessment dated December 2005.
MP-085	ICC Case No. 12990, Final Award dated December 2005.
MP-086	U.S. Government Accountability Office, <i>Company Formations: Minimal Ownership Information Is Collected and Available</i> dated April 2006.
MP-087	ICC Case No. 13515, Final Award dated April 2006.
MP-088	G.T. Ware e.a., 'Corruption in Public Procurement. A Perennial Challenge', in: J.E. Campos & S. Pradhan (red.), <i>The Many Faces of Corruption. Tracking Vulnerabilities at the Sector Level</i> , Washington, D.C.: The World Bank 2007.
MP-089	M.N. Davies, 'The Role of Agents and Other Intermediaries', in: F. Heimann & F. Vincke (red.), <i>Fighting Corruption: International Corporate Integrity Handbook</i> , Paris: ICC Publisher S.A. 2008.
MP-090	ICC Case No. 13914, ICC Bulletin 2013, Final Award dated March 2008.
MP-091	Woolf Committee Report, <i>Business ethics, global companies and the defence industry: Ethical business conduct in BAE Systems plc – the way forward</i> , dated May 2008.
MP-092	OECD Money Laundering Awareness Handbook for Tax Examiners and Tax Auditors (2009).
MP-093	D. Chaikin & J.C. Sharman, <i>Corruption and Money Laundering. A Symbiotic Relationship</i> , New York, NY: Palgrave MacMillan 2009.
MP-094	<i>In re Application of Mikhail B. Khodorkovsky</i> , Case No. 09-cv-2185 (S.D. Cal.) [U.S. District Court for the Southern District of California], Deposition of Douglas Miller dated 18 December 2009.
MP-095	OECD Anti-Corruption Network for Eastern Europe and Central Asia, <i>Expert Seminar: 'Effective Means of Investigation and Prosecution of Corruption'</i> , dated October 2010.
MP-096	Financial Action Task Force, <i>Money Laundering Using Trust and Company Service Providers</i> dated October 2010.
MP-097	ICC Commission on Corporate Responsibility and Anti-Corruption, <i>ICC Guidelines on Agents, Intermediaries and Other Third Parties</i> dated 19 November 2010.
MP-098	OECD Convention on Combating Bribery of Foreign Public Officials in International Business Transactions dated 2011.
MP-099	M. Pieth, 'Contractual Freedom v. Public Policy Considerations in Arbitration', in: A. Büchler & M.Müller-Chen (red.), <i>Private Law: national-global-comparative. Festschrift für Ingeborg Schwenzer zum 60. Geburtstag</i> , 2011.
MP-100	Stolen Asset Recovery Initiative, <i>The Puppet Masters: How the Corrupt Use Legal Structures to Hide Stolen Assets and What to Do About It</i> dated 2011.
MP-101	Financial Action Task Force, <i>Laundering the Proceeds of Corruption</i> dated July 2011.

UNOFFICIAL TRANSLATION

This text is an unofficial translation of the Dutch original. In case of any discrepancies, the Dutch original shall prevail.

Exhibit	Description
MP-102	FCPA: A Resource Guide to the U.S. Foreign Corrupt Practices Act, U.S. Department of Justice and U.S. Securities and Exchange Commission dated 2012.
MP-103	OECD Working Group, Phase 1 Report on Implementing the OECD Anti-Bribery Convention in the Russian Federation dated 16 March 2012.
MP-104	<i>Jan Oostergetel and Theodora Laurentius v. Slovak Republic</i> , UNCITRAL, Award dated 23 April 2012.
MP-105	<i>Berezovsky v. Abramovich</i> , [2012] EWHC 2463 (Comm) [English Commercial Court] dated 31 August 2012.
MP-106	The World Bank, <i>Fraud and Corruption Awareness Handbook</i> , 2013.
MP-107	<i>Metal-Tech Ltd. v. Republic of Uzbekistan</i> , ICSID Case No. ARB/10/3, Award dated 4 October 2013.
MP-108	M. Pieth, 'Article 7: Money Laundering', in: M. Pieth, L.A. Low, & N. Bonucci (red.), <i>The OECD Convention on Bribery: A Commentary</i> , 2014.
MP-109	I. Zerbes, 'The Offense of Bribery of Foreign Public Officials', in: M. Pieth, L.A. Low & P.J. Cullen (eds.), <i>The OECD Convention on Bribery. A Commentary</i> , Cambridge, UK: Cambridge University Press 2014.
MP-110	<i>Fraport AG Frankfurt Airport Services Worldwide v. Philippines II</i> , ICSID Case No. ARB/11/12, Award dated 10 December 2014.
MP-111	Expert Report of S.P. Kothari dated 20 October 2015.
MP-112	S. Rose-Ackerman, <i>Corruption and Government. Causes, Consequences, and Reform</i> , New York, NY: Cambridge University Press 2016.
MP-113	Letter from Tim Osborne to <i>American Lawyer</i> dated 5 August 2016.
MP-114	Financial Action Task Force, <i>International Standards on Combating Money Laundering and the Financing of Terrorism & Proliferation: The FATF Recommendations</i> dated October 2016.
MP-115	J.E. Stiglitz & M. Pieth, <i>Overcoming the Shadow Economy</i> dated November 2006.
MP-116	Services Agreement between Mikhail B. Khodorkovsky and Hinchley Ltd. dated 10 January 1996.
MP-117	Services Agreement between Mikhail B. Khodorkovsky and Hinchley Ltd. dated 20 January 1997.
MP-118	Services Agreement between Mikhail B. Khodorkovsky and Hinchley Ltd. dated 15 August 1997.
MP-119	Services Agreement between Vasily S. Shakhnovsky and Hinchley Ltd. dated 6 October 1997.
MP-120	Services Agreement between Mikhail B. Khodorkovsky and Hinchley Ltd. dated 3 November 1997.
MP-121	Services Agreement between Mikhail B. Khodorkovsky and Hinchley Ltd. dated 20 January 1998.
MP-122	Services Agreement between Mikhail B. Khodorkovsky and Status Services Ltd. dated 2 March 1998.
MP-123	Services Agreement between Vasily S. Shakhnovsky and Status Services Ltd. dated 1 April 1998.

UNOFFICIAL TRANSLATION

This text is an unofficial translation of the Dutch original. In case of any discrepancies, the Dutch original shall prevail.

Exhibit	Description
MP-124	Services Agreement between Mikhail B. Khodorkovski and Status Services Ltd. dated 5 October 1998.
MP-125	Services Agreement between Mikhail B. Khodorkovski and Status Services Ltd. dated 30 November 1998.
MP-126	Services Agreement between Vasily S. Shakhnovsky and Status Services Ltd. dated 25 January 1999.
MP-127	Services Agreement between Mikhail B. Khodorkovski and Status Services Ltd. 20 April 1999.
MP-128	Services Agreement between Platon L. Lebedev and Status Services Ltd. 1 July 1999.
MP-129	Services Agreement between Vasily S. Shakhnovsky and Status Services Ltd. 30 August 1999.
MP-130	Services Agreement between Michael B. Brudno and Status Services Ltd. 2 September 1999.
MP-131	Services Agreement between Vasily S. Shakhnovsky and Status Services Ltd. 1 October 1999.
MP-132	Services Agreement between Leonid B. Nevzlin and Status Services Ltd. dated 27 October 1999.
RF-D14	Expert Opinion of Professor Dr. Dr. h.c. Mark Pieth dated 10 October 2017 with Annexes on the USB stick.
Annex D	Overview Annexes attached to the Expert Opinion of Professor Dr. Dr. h.c. Mark Pieth dated 10 October 2017.
Annex E	Expert Opinion of Professor Rebut dated 16 March 2017. English translation by the Russian Federation.
Annex F	Witness Statement of Dubov dated 13 March 2017. English translation by the Russian Federation.
MP-133	Council of Europe, Committee of Ministers Recommendation No. R (87) 18 of the Committee of Ministers to member States Concerning the Simplification of Criminal Justice dated 17 September 1987.
MP-134	Statute No. 948-I “on Competition and Limitation of Monopolistic Activity” dated 22 March 1991.
MP-135	Statute No.1531-I “on Privatization of the State and Municipal Enterprises in the Russian Federation” dated 3 July 1991.
MP-136	Cabinet of Ministers Resolution No. 383-r (Certified Translation “New York”) dated 6 March 1993.
MP-137	Cabinet of Ministers Resolution No. 383-r (Certified Translation “California”) dated 6 March 1993.
MP-138	Resolution No. 342-r dated 15 February 1994.
MP-139	Mikhail Khodorkovsky’s Facebook Post dated 9 June 2016.
MP-140	Yukos, RFPF and RF State Committee for Management of State Property Contract No. 2-14.2./473 dated 25 July 1994.
MP-141	First Expert Report of Professor Pieth dated 27 January 2017.
MP-142	Commercial Court of Moscow (Appellate Instance) Resolution re revision of legality and reasonableness of judgment of inferior court in Case No. 39-50 dated 30 May 1996.

UNOFFICIAL TRANSLATION

This text is an unofficial translation of the Dutch original. In case of any discrepancies, the Dutch original shall prevail.

Exhibit	Description
MP-143	State Property Committee Order 995-r dated 24 July 1995.
MP-144	Note on Yukos Annual Shareholders' Meeting (HVY Piece No. 341) dated 20 June 2001.
MP-145	Articles of Association of Group Menatep Limited.
MP-146	Resolution of State Committee for Management of State Property No. 1547-r dated 25 October 1995.
MP-147	YUKOS Investment Tender Public Notice dated 4 November 1995.
MP-148	Meeting of Tender Commission for Investment Tender in Respect of Shares of Yukos Protocol No. 1 dated 8 December 1995.
MP-149	Meeting of Tender Committee on Summary of the Investment Tender Protocol No. 2 dated 8 December 1995.
MP-150	L. Françoise, 'Concerns about the continuation of the privatization program', <i>La Monde</i> 20 December 1995.
MP-151	A. Zhigulsky & J. Bernstein, 'Auctions End on Contentious Note', <i>Moscow Times</i> 29 December 1995.
MP-152	Agreement on Fulfilment of Investment Project between AOOT Oil Company "Yukos" and ZAO Laguna (Excerpted Page 5) dated 12 January 1996.
MP-153	A. Budrys, 'Unknown Monblan Wins Third of Russia's YUKOS', <i>Reuters</i> 23 December 1996.
MP-154	Annual Report of Yukos for 1998 (Piece HVY No. 348).
MP-155	OPEC Chart of Oil Reserves 1998.
MP-156	Report of Yukos Oil Corporation "Yukos and Sibneft to Combine Operations Create World's Largest Oil Company Based on Reserves" dated 19 January 1998.
MP-157	Share Purchase Agreement No. 8 KA-KI/1 dated 24 March 1998.
MP-158	Share Purchase Agreement No. 8 EB-TE/1 dated 24 March 1998.
MP-159	Share Purchase Agreement No. 8 AV-CA/1 dated 24 March 1998.
MP-160	Share Purchase Agreement No. 8 ME-WA/1 dated 24 March 1998.
MP-161	Form of Annual Return, List of Shareholders, and List of Directors of Group Menatep Limited dated 20 September 1999.
MP-162	Ordinary and Special Resolutions of Flaymon Limited, Group Menatep Limited, and GML Limited.
MP-163	State Duma Resolution N 3331-II GD "on the Prevention of the Transfer to the Ownership of Non-residents of the Russian Federation of Shares in Joint Stock Companies that have a Strategic Importance for National Security of the State" dated 4 December 1998.
MP-164	OECD Working Group Phase 1 Review of Implementation of the Convention and 1997 Recommendation in the United States, 1999.
MP-165	Form of Annual Return, List of Shareholders, and List of Directors of Group Menatep Limited dated 30 September 1998.
MP-166	OECD Working Group Phase 1 Review of Implementation of the Convention and 1997 Recommendation in France, 2000.
MP-167	OECD Working Group Phase 1 Report on Implementing the OECD Anti-Bribery Convention and 1997 Recommendation in Switzerland, 2000.

UNOFFICIAL TRANSLATION

This text is an unofficial translation of the Dutch original. In case of any discrepancies, the Dutch original shall prevail.

Exhibit	Description
MP-168	Annual Report of Yukos for 2000 (Piece HVY No. 343) dated 2000.
MP-169	Sale Agreement between Cayard, Hulley and Avimore dated 9 March 2000.
MP-170	Sale Agreement between Temerain, Hulley, Ebon and TBH dated 9 March 2000.
MP-171	Sale Agreement between Kincaid, Hulley and Kandall dated 9 March 2000.
MP-172	Sale Agreement between Wandsworth, Hulley and Medusa dated 9 March 2000.
MP-173	Sale Agreement between Barion, Hulley, Hawksmor, Henry and MQD dated 9 March 2000.
MP-174	L. S. Wolosky, 'Putin's Plutocrat Problem', <i>Foreign Affairs</i> April 2000.
MP-175	Interview with Joseph Stiglitz, <i>Progressive.org</i> dated 16 June 2000.
MP-176	Form of Annual Return, List of Shareholders, and List of Directors of Group Menatep Limited dated 29 September 2000.
MP-177	OECD Working Group Phase 2 Report on the Application of the Convention on Combating Bribery of Foreign Public Officials in International Business Transactions and the 1997 Recommendations on Combating Bribery in International Business Transactions in the United States October 2002
MP-178	Paul Klebnikov, 'The Khodorkovsky Affair', <i>The Wall Street Journal</i> 17 november 2003.
MP-179	Decision of Commercial Court of Moscow in case of OOO Rusatommet dated 28 September 2005.
MP-180	OECD Working Group Phase 2 Report on the Application of the Convention on Combating Bribery of Foreign Public Officials in International Business Transactions and the 1997 Recommendations on Combating Bribery in International Business Transactions in the Netherlands dated 15 June 2006.
MP-181	OECD Working Group Phase 3 Report on Implementing the OECD Anti-Bribery Convention in the United States dated 15 October 2010.
MP-182	OECD Working Group Phase 3 Report on Implementing the OECD Anti-Bribery Convention in Switzerland dated 16 December 2011.
MP-183	J. Sachs, What I did in Russia, jeffsachs.org dated 14 March 2012.
MP-184	OECD Working Group Phase 1 Report on Implementing the OECD Anti-Bribery Convention in the Russian Federation dated 16 March 2012.
MP-185	OECD Working Group Phase 3 Report on Implementing the OECD Anti-Bribery Convention in France dated 12 October 2012.
MP-186	OECD Working Group Phase 3 Report on Implementing the OECD Anti-Bribery Convention in the Netherlands dated 14 December 2012.
RF-D15	Expert Opinion of Professor S.P. Kothari dated 26 November 2017 with Annexes on the USB stick.
SPK-01	Global Master Purchase Agreement between West Merchant and Bank Menatep dated 4 December 1997.
SPK-02	Russian Investors Registration Form dated 1 January 1998.
SPK-03	Press Release about the YUKOS-Sibneft Merger dated 19 January 1998.
SPK-04	Swap Transaction No. STF 98011095 between Daiwa and Bank Menatep dated 29 January 1998.
SPK-05	Hulley Unanimous Written Resolution of the General Meeting of the Company dated 20 February 1998.

UNOFFICIAL TRANSLATION

This text is an unofficial translation of the Dutch original. In case of any discrepancies, the Dutch original shall prevail.

Exhibit	Description
SPK-06	Stock Purchase Agreement between Hawksmoor and Barion dated 24 March 1998.
SPK-07	Stock Purchase Agreement between Avimore and Cayard dated 24 March 1998.
SPK-08	Purchase Agreement between Medusa and Wandsworth dated 24 March 1998.
SPK-09	Stock Purchase Agreement between Ebon Crown and Temerain dated 24 March 1998.
SPK-10	Purchase Agreement between Kandall and Kincaid dated 24 March 1998.
SPK-11	Equity Swap Transaction No. STF 98031194 between Daiwa and Bank Menatep dated 21 April 1998.
SPK-12	Letter from Daiwa to Bank Menatep and YUKOS dated 15 September 1998.
SPK-13	Menatep-West Merchant Repo Restructuring Preliminary Basic Points for the Term Sheet dated 28 November 1998.
SPK-14	Letter from West Merchant to Bank Menatep dated 30 November 1998.
SPK-15	Letter from Daiwa to Bank Menatep dated 8 December 1998.
SPK-16	Letter from YUKOS to Daiwa dated 21 December 1998.
SPK-17	Letter from YUKOS to Daiwa dated 29 December 1998.
SPK-18	Letter from YUKOS to WestLB dated 29 December 1998.
SPK-19	Letter from YUKOS to WestLB dated 18 January 1999.
SPK-20	Letter from YUKOS to WestLB dated 2 February 1999.
SPK-21	Fax from Daiwa to YUKOS dated 26 February 1999.
SPK-22	Letter from West Merchant to YUKOS dated 18 March 1999.
SPK-23	South Petroleum Agreement with TIB dated 22 March 1999.
SPK-24	Depository Agreement between Wandsworth and Russian Investors dated 29 March 1999.
SPK-25	Depository Agreement between Cayard and Russian Investors dated 29 March 1999.
SPK-26	Letter from West Merchant to YUKOS dated 31 March 1999.
SPK-27	Depository Agreement between Barion and TIB dated 1 April 1999.
SPK-28	Depository Agreement between Kincaid and TIB dated 1 April 1999.
SPK-29	Letter from SBLL to South Petroleum dated 26 May 1999.
SPK-30	Alan S. Cullison, Yukos Quietly Transfers Oil Assets Out of Russia, <i>The Wall Street Journal</i> 4 June 1999.
SPK-31	Letter from Westdeutsche to YUKOS dated 24 June 1999.
SPK-32	Letter from Daiwa to Bank Menatep dated 28 June 1999.
SPK-33	Letter from SBLL to South Petroleum dated 6 July 1999.
SPK-34	Assignment Agreement between SBLL and South Petroleum dated 6 July 1999.
SPK-35	Fax from SBLL to South Petroleum dated 7 July 1999.
SPK-36	A.S. Cullison, 'Vanishing Act: Share Shuffling Saps Oil Giant Yukos Nearly Dry', <i>The Wall Street Journal</i> 15 July 1999.
SPK-37	Fax from WestLB to YUKOS dated 15 July 1999.
SPK-38	Letter from West Merchant to Bank Menatep Bankruptcy Trustee dated 28 July 1999.
SPK-39	Letter from South Petroleum to TIB dated 2 August 1999.
SPK-40	Letter from SBLL to TIB dated 21 September 1999.

UNOFFICIAL TRANSLATION

This text is an unofficial translation of the Dutch original. In case of any discrepancies, the Dutch original shall prevail.

Exhibit	Description
SPK-41	Assignment Agreement between SBLL and TIB dated 18 October 1999.
SPK-42	Letter from SBLL to TIB dated 19 October 1999.
SPK-43	Letter from West Merchant to Bank Menatep dated 20 October 1999.
SPK-44	Letter from SBLL to TIB dated 20 October 1999.
SPK-45	Pledge Agreement between SBLL and TIB dated 20 October 1999.
SPK-46	Letter from TIB to SBLL dated 26 October 1999.
SPK-47	Contract between YUL and TIB dated 28 October 1999.
SPK-48	Assignment Agreement between TIB and Bonaterm dated 17 December 1999.
SPK-49	Assignment Agreement between Leadfair and BMSP dated 24 December 1999.
SPK-50	Letter from TIB to ZAO "M-Reestr" dated 17 January 2000.
SPK-51	Letter from BMSP to ZAO "M-Reestr" dated 19 January 2000.
SPK-52	Letter from Russian Investors to ZAO "M-Reestr" dated 20 January 2000.
SPK-53	Sale Agreement between Kincaid and Hulley dated 9 March 1999.
SPK-54	Sale Agreement between Temerain and Hulley dated 9 March 1999.
SPK-55	Sale Agreement between Cayard and Hulley dated 9 March 1999.
SPK-56	Sale Agreement between Wandsworth and Hulley dated 9 March 1999.
SPK-57	Sale Agreement between Barion and Hulley dated 9 March 1999.
SPK-58	Agreement between TIB and YUL dated 22 May 2000.
SPK-59	Novation Agreement between TIB, YUL, and SBLL dated 26 May 2000.
SPK-60	Letter from South Petroleum to SBLL dated November 2000.
SPK-61	Letter from YUKOS to SBLL dated 15 November 2000.
SPK-62	S. Johnson et al., 'Tunneling', <i>The American Economic Review</i> (Vol. 90) 2000, nr. 2.
SPK-63	Deed of Transfer between YUL and WJB Chiltern Trust Company (Jersey) Limited dated 25 April 2001.
SPK-64	Notification on Closing a Securities Account from Russian Investors to Cayard dated 20 July 2001.
SPK-65	Notification on Closing a Securities Account from Russian Investors to Wandsworth dated 24 July 2001.
SPK-66	Brunswick UBS Warburg Nominees Holding Account for VPL dated 12 May 2002.
SPK-67	YUKOS Annual Report 2002
SPK-68	YUKOS Share Registry - Translation of Relevant Transactions dated 1997-2002.
SPK-69	Email from Pavel Maliy to Andre de Cort dated 15 September 2003.
SPK-70	YUKOS Quarterly Report 2003, 3rd Quarter.
SPK-71	T. Nenova, 'The value of corporate voting rights and control: A cross-country analysis', <i>Journal of Financial Economics</i> 2003, no. 68.
SPK-72	A. Dyck & L. Zingales, 'Private Benefits of Control: An International Comparison', <i>The Journal of Finance</i> 2004, no. 59.
SPK-73	YUKOS Annual Report 2003 dated 19 January 2005.
SPK-74	Statement No. 2456 of Transactions for the Period from 27 Oct. 1999 to 3 Oct. 2006 dated 4 October 2006.

UNOFFICIAL TRANSLATION

This text is an unofficial translation of the Dutch original. In case of any discrepancies, the Dutch original shall prevail.

Exhibit	Description
SPK-75	Customer Account Statement for the period from 25 April 2001 to 11 October 2006 for VPL.
SPK-76	OECD, Joint Audit Report, Sixth Meeting of the OECD Forum on tax Administration dated 2010.
SPK-77	OECD, Global Forum on Transparency and Exchange of Information for Tax Purposes Peer Reviews: Russian Federation dated 2012.
SPK-78	R. Durrieu, <i>Rethinking Money Laundering & Financing of Terrorism in International Law. Towards a New Global Legal Order</i> , Leiden-Boston: Martinus Nijhof Publishers 2013.
SPK-79	M. Wright et al. (eds.), <i>The Oxford Handbook of Corporate Governance</i> , Oxford (UK): Oxford University Press 2013.
SPK-80	<i>Hulley Enters. v. Russian Federation</i> , PCA Case No. AA 226, Final Award, at A-6, Table T1 dated 18 July 2014.
SPK-81	Expert Report of S.P. Kothari dated 20 October 2015.
SPK-82	Expert Report of J. Christopher Racich dated 9 March 2017.
SPK-83	Letter from Eurofinance to ZAO “M-Reestr” dated 18 January 2000.
Article 1(6) and 1(7) ECT	
RF-D16	Expert Opinion of Professor Alain Pellet dated 9 November 2017.
RF-D17	Expert Opinion of Andreas Michaelides dated 26 November 2017 with Annexes on the USB stick.
Annex A	Overview Annexes attached to the Expert Opinion of Andreas Michaelidis dated 26 November 2017.
Exhibit AM-01	Curriculum Vitae of Andreas Michaelides.
Exhibit AM-02	Agreement between the Government of the Republic of Cyprus and the Government of the Russian Federation for the avoidance of double taxation with respect to taxes on income and on capital, signed on 5 December 1998 and entered into force on 17 August 1999.
Exhibit AM-03	Courts of Justice Law of 1960 (Law no.14/1960), Select Provisions.
Exhibit AM-04	<i>Theofanous v. Cosmos Insurance</i> (1988) 1 CLR 265 dated 25 April 1988.
Exhibit AM-05	<i>Salomon v. Salomon</i> [1897] A.C.22 dated 16 November 1980.
Exhibit AM-06	<i>Michaelides v. Gavrielides</i> (1980) 1 CLR 244
Exhibit AM-07	<i>Bank of Cyprus (Holdings) Ltd v. The Republic of Cyprus through the Commissioner of Income Tax</i> (1983) 3 CLR 636 dated 28 May 1983.
Exhibit AM-08	<i>Matero Limited v. The Republic of Cyprus through the Minister of Finance and the Director of the Department of Customs and Excise</i> (1986) 3 CLR 1574 dated 18 September 1986.
Exhibit AM-09	<i>Republic of Cyprus through the Minister of Communications and Works v. KEM Taxi Limited</i> (1987) 3 CLR 1057 dated 21 July 1987.
Exhibit AM-10	<i>Stereo Development Co. Ltd v. 1. The Income Tax Commissioner and 2. The Director of the Inland Revenue Department</i> (1998) 4 CLR 651 dated 5 August 1998.

UNOFFICIAL TRANSLATION

This text is an unofficial translation of the Dutch original. In case of any discrepancies, the Dutch original shall prevail.

Exhibit	Description
Exhibit AM-11	<i>Mitsios Trading Limited v. the Republic of Cyprus through the Ministry of Finance and the Commissioner of Income Tax</i> (1987) 3 CLR 1455 dated 3 October 1987.
Exhibit AM-12	<i>Othon Galanos Tax Free Shops Ltd v. the Republic of Cyprus through the Director of the Department of Civil Aviation</i> (1990) 3 CLR 2234 dated 27 June 1990.
Exhibit AM-13	<i>Apostolou v. Ioannou</i> (2012) 1 CLR 604 dated 3 April 2012.
Exhibit AM-14	<i>Ben Hashem v. Al Shayif & Anor</i> [2008] EWHC 2380 dated 22 September 2008.
Exhibit AM-15	Russian Tax Service Forms (Form 1013DT) filed by Hulley dated 2000-2001.
Exhibit AM-16	Russian Tax Service Forms (Form 1013DT) by Veteran dated 2000-2001.
Exhibit AM-17	Criminal Code of Cyprus, Select Provisions.
Exhibit AM-18	G. Babiniotis – Dictionary of the Modern Greek Language, 2nd edition, 2002, Excerpts
Exhibit AM-19	T. R. F. Butler & M. Garsia, <i>Archbold Pleadings, Evidence and Practice in Criminal Cases</i> , London: Sweet&Maxwell 1966.
Exhibit AM-20	<i>Lennard's Carrying Co Ltd v. Asiatic Petroleum Co Ltd</i> [1915] AC 705 dated 8 March 1915.
Exhibit AM-21	<i>Tesco Supermarkets Ltd v Natrass</i> [1972] AC 153 dated 1972.
Exhibit AM-22	Companies' Law of Cyprus, Select Provisions.
Exhibit AM-23	Confirmation and Collection of Taxes Law of 1978 (Law 4/1978), Select Provisions dated 1978.
Exhibit AM-24	The Concealment, Search and Confiscation of Proceeds from Certain Criminal Acts Law of 1996 (61(I)/1996) dated 1975.
Exhibit AM-25	A.N. Loizou & G.M. Piki, <i>Criminal Procedure in Cyprus</i> , Nicosia: Proodos Press 1975.
Exhibit AM-26	European Convention for the Protection of Human Rights and Fundamental Freedoms, Select Provisions dated 3 September 1953.
Exhibit AM-27	Constitution of the Republic of Cyprus dated 16 August 1960.
Exhibit AM-28	<i>Attorney General v. Vasili Vasou</i> (2005) 2 CLR 653 dated 16 December 2005.
Exhibit AM-29	Criminal Procedure Law 1959.
Damages	
RF-D18	Expert Opinion of Professor James Dow dated 28 November 2017.
RF-D19	Expert Opinion of Hermes Advisory dated 27 November 2017.

UNOFFICIAL TRANSLATION

This text is an unofficial translation of the Dutch original. In case of any discrepancies, the Dutch original shall prevail.

Assistant of the Tribunal	
RF-D20	Expert Opinion of Carole E. Chaski, Ph.D. dated 17 November 2017 with Annexes on the USB stick.
Annex A	Details regarding Dr. Carole Chaski's Publications.
Annex B	Comparison of Citations of Publications used as Authorities.
Annex C	Overview of the Tests that were run (In Chronological Order).
Annex D	Note on DFA Assumptions.
Annex E	List of Publications where the Comparison Documents were featured.
Annex F	Testing Prof. Coulthard's original and edited texts using ALIAS SynAID.
Annex G	List of Publications and other Authorities cited in the Chaski Report.
Annex H	List of Cases in which Dr. Carole Chaski has provided Expert Reports, Expert Analysis or Investigation services.
RF-D21	Expert Opinion of Professor Dr. W. Daelemans dated 22 November 2017. (First Daelemans Report)
RF-D22	Expert Opinion of Professor Dr. W. Daelemans dated 22 November 2017. (Second Daelemans Report)

UNOFFICIAL TRANSLATION

This text is an unofficial translation of the Dutch original. In case of any discrepancies, the Dutch original shall prevail.

D. Overview of witness statements in First Instance and Defence on Appeal [with annexes]

ORAL PLEADINGS	
Exhibit	Description
Article 1(6) and 1(7) ECT	
RF-200	Witness Statement of Gitas Povilo Anilionis dated 16 October 2015.
R-1 (=RF-225)	RTT Certificate of Registration dated 24 September 1992.
R-2 (=RF-225)	RTT Joint Venture Charter §§ 1.11, 3.1 dated 8 December 1997.
R-3 (=RF-225)	List of RTT Employees dated 1 September 1995.
R-4 (=RF-225)	Loans for Shares Auction Minutes No. 1 dated 8 December 1995.
R-5 (=RF-225)	Loans for Shares Auction Minutes No. 2 dated 8 December 1995.
R-6 (=RF-225)	ZAO Laguna Application dated 5 December 1995.
R-7 (=RF-225)	Commission Agreement No. 2-11-2-981 dated 13 December 1995.
R-8 (=RF-225)	Pledge Agreement No. 0I-2-2761 dated 13 December 1995.
R-9 (=RF-225)	Stock Purchase Agreement No. 1-12-1-990 dated 14 December 1995.
R-10 (=RF-225)	Stock Purchase Agreement L/A-1 dated 24 January 1996.
R-11 (=RF-225)	Stock Purchase Agreement L/T-1 dated 24 January 1996.
R-12 (=RF-225)	Stock Purchase Agreement No. Y-51/97 dated 5 May 1997.
R-13 (=RF-225)	Assignment Agreement No. 198 dated 13 December 1995.
R-14 (=RF-225)	Stock Purchase Agreement Ts-703 dated 24 December 1996.
R-15 (=RF-225)	Stock Purchase Agreement No. Y-52/97 dated 5 May 1997.
R-16 (=RF-225)	Securities Purchase Agreement No. S/15/99 dated 10 February 1999.
R-17 (=RF-225)	Securities Purchase Agreement No. 01/Y dated 17 November 1998.
R-18 (=RF-225)	Stock Purchase Agreement No. KA-KI/1 dated 24 March 1998.
R-19 (=RF-225)	Stock Purchase Agreement No. EB-TE/1 dated 24 March 1998.
R-20 (=RF-225)	Stock Purchase Agreement No. AV-CA/1 dated 24 March 1998.

UNOFFICIAL TRANSLATION

This text is an unofficial translation of the Dutch original. In case of any discrepancies, the Dutch original shall prevail.

Exhibit	Description
R-21 (=RF-225)	Stock Purchase Agreement No. ME-WA/1 dated 24 March 1998.
R-22 (=RF-225)	Stock Purchase Agreement No. HA-BA/1 dated 24 March 1998.
R-23 (=RF-225)	Stock Purchase Agreement No. DK-1012/1 dated 17 June 1998.
R-24 (=RF-225)	Sale Agreement between Kincaid and Hulley dated 9 March 2000.
R-25 (=RF-225)	Sale Agreement between Temerein and Hulley dated 9 March 2000.
R-26 (=RF-225)	Sale Agreement between Cayard and Hulley dated 9 March 2000.
R-27 (=RF-225)	Sale Agreement between Wandsworth and Hulley dated 9 March 2000.
R-28 (=RF-225)	Sale Agreement between Barion and Hulley dated 9 March 2000.
R-29 (=RF-225)	Foundation Agreement of OOO Business-Oil dated 23 December 1997.
R-30 (=RF-225)	Foundation Agreement of OOO Mitra dated 10 December 1997.
R-31 (=RF-225)	Foundation Agreement of OOO Wald-Oil dated 24 December 1997.
R-32 (=RF-225)	Foundation Agreement of OOO Forest-Oil dated 22 December 1997.
R-33 (=RF-225)	Foundation Agreement of OOO Kverkus dated 14 July 1997.
R-34 (=RF-225)	Foundation Agreement of OOO Alebra dated 16 July 1997.
R-35 (=RF-225)	Foundation Agreement of OOO Grace dated 16 July 1997.
R-36 (=RF-225)	Foundation Agreement of OOO Nortex dated 18 July 1997.
R-37 (=RF-225)	Pre-2000 Yukos Shares Transfers dated 16 October 2015.
RF-201	Witness Statement of Arkady Vitalyevich Zakharov dated 14 October 2015.
R-3 (=RF-225)	List of RTT Employees dated 1 September 1995.
R-4 (=RF-225)	Loans for Shares Auction Minutes No. 1 dated 8 December 1995.
R-5 (=RF-225)	Loans for Shares Auction Minutes No. 2 dated 8 December 1995.
R-6 (=RF-225)	ZAO Laguna Application dated 5 December 1995.
R-9 (=RF-225)	Stock Purchase Agreement No. 1-12-1-990 dated 14 December 1995.

UNOFFICIAL TRANSLATION

This text is an unofficial translation of the Dutch original. In case of any discrepancies, the Dutch original shall prevail.

Exhibit	Description
R-10 (=RF-225)	Stock Purchase Agreement L/A-1 dated 24 January 1996.
R-11 (=RF-225)	Stock Purchase Agreement L/T-1 dated 24 January 1996.
R-12 (=RF-225)	Stock Purchase Agreement No. Y-51/97 dated 5 May 1997.
R-13 (=RF-225)	Assignment Agreement No. 198 dated 13 December 1995.
R-14 (=RF-225)	Stock Purchase Agreement Ts-703 dated 24 December 1996.
R-15 (=RF-225)	Stock Purchase Agreement No. Y-52/97 dated 5 May 1997.
R-18 (=RF-225)	Stock Purchase Agreement No. KA-KI/1 dated 24 March 1998.
R-19 (=RF-225)	Stock Purchase Agreement No. EB-TE/1 dated 24 March 1998.
R-20 (=RF-225)	Stock Purchase Agreement No. AV-CA/1 dated 24 March 1998.
R-21 (=RF-225)	Stock Purchase Agreement No. ME-WA/1 dated 24 March 1998.
R-22 (=RF-225)	Stock Purchase Agreement No. HA-BA/1 dated 24 March 1998.
R-24 (=RF-225)	Sale Agreement between Kincaid and Hulley dated 9 March 2000.
R-25 (=RF-225)	Sale Agreement between Temerein and Hulley dated 9 March 2000.
R-26 (=RF-225)	Sale Agreement between Cayard and Hulley dated 9 March 2000.
R-27 (=RF-225)	Sale Agreement between Wandsworth and Hulley dated 9 March 2000.
R-28 (=RF-225)	Sale Agreement between Barion and Hulley dated 9 March 2000.
R-29 (=RF-225)	Foundation Agreement of OOO Business-Oil dated 23 December 1997.
R-30 (=RF-225)	Foundation Agreement of OOO Mitra dated 10 December 1997.
R-31 (=RF-225)	Foundation Agreement of OOO Wald-Oil dated 24 December 1997.
R-32 (=RF-225)	Foundation Agreement of OOO Forest-Oil dated 22 December 1997.
R-33 (=RF-225)	Foundation Agreement of OOO Kverkus dated 14 July 1997.
R-34 (=RF-225)	Foundation Agreement of OOO Alebra dated 16 July 1997.

UNOFFICIAL TRANSLATION

This text is an unofficial translation of the Dutch original. In case of any discrepancies, the Dutch original shall prevail.

Exhibit	Description
R-35 (=RF-225)	Foundation Agreement of OOO Grace dated 16 July 1997.
R-36 (=RF-225)	Foundation Agreement of OOO Nortex dated 18 July 1997.
R-55 (=RF-225)	Sale Agreement between Yukos Universal Limited and Hulley Enterprises Limited dated 10 January 2000.
R-56 (=RF-225)	Option Agreement between Yukos Universal Limited and Hulley Enterprises Limited dated 11 January 2000.
R-57 (=RF-225)	Notice under the Option Agreement of 11 January 2000 dated 11 May 2000.
R-58 (=RF-225)	Notice under the Option Agreement of 11 January 2000 dated 30 October 2000.
R-60 (=RF-225)	Report regarding the Sale of Shares of OAO Yukos Oil Company dated 24 December 1995.
R-61 (=RF-225)	Securities Purchase Agreement between MQD and Barion dated 17 November 1998.
Background	
RF-222	Witness Statement of A.G. Burutin dated 15 January 2016.

UNOFFICIAL TRANSLATION

This text is an unofficial translation of the Dutch original. In case of any discrepancies, the Dutch original shall prevail.

DEFENCE ON APPEAL	
Exhibit	Description
Article 45 ECT	
RF-G1	Witness Statement of V.S. Katrenko dated 21 November 2017 with Annexes on the USB stick.
VSK-01	The Constitution of the Russian Federation, Article 15 dated 12 December 1993.
VSK-02	Government of the Russian Federation Resolution No. 1390 “on the Execution of the Energy Charter Treaty and Related Documents” dated 16 December 1994.
VSK-03	Energy Charter Treaty dated 17 December 1994.
VSK-04	Federal Statute No. 101-FZ “on International Treaties of the Russian Federation”, Article 17 dated 15 July 1995.
VSK-05	Government of the Russian Federation Decree No. 1016 “on the Approval and Submission of the Energy Charter Treaty and the Energy Charter Protocol on Energy Efficiency and Related Environmental Aspects for Ratification before the State Duma of the Federal Assembly of the Russian Federation” dated 26 August 1996.
VSK-06	Government of the Russian Federation Explanatory Note to the Draft Federal Statute “on Ratification of the Energy Charter Treaty and the Energy Charter Protocol on Energy Efficiency and Related Environmental Aspects” dated 26 August 1996.
VSK-07	State Duma Council Administrative Hearing Record No. 44 dated 17 October 1996.
VSK-08	State Duma Committee on Economic Policy Explanatory Note prepared for the Parliamentary Hearing on the Energy Charter Treaty and the Energy Charter Protocol on Energy Efficiency and Related Environmental Aspects dated 19 February 1997.
VSK-09	State Duma Parliamentary Hearings Information Notes in <i>Analytics and Statistics</i> : Spring Session of 1997 dated 17 June 1997.
VSK-10	State Duma Committee on Economic Policy Parliamentary Hearing Transcript “on the Energy Charter Treaty and the Energy Charter Protocol on Energy Efficiency and Related Environmental Aspects” dated 17 June 1997.
VSK-11	State Duma Committee on Economic Policy Parliamentary Hearing Recommendations “on the Energy Charter Treaty and the Energy Charter Protocol on Energy Efficiency and Related Environmental Aspects” dated 17 June 1997.
VSK-12	State Duma Parliamentary Hearings Informational and Analytical Materials dated 26 January 2001.
VSK-13	State Duma Energy Committee Parliamentary Hearing Transcript “on the Ratification of the Energy Charter Treaty (ECT)” (Editorial Version) dated 26 janurari 2001.
VSK-14	State Duma Energy Committee Hearing Recommendations “on Ratification of the Energy Charter Treaty” dated 26 January 2001.
VSK-15	State Duma Council Administrative Hearing Record No. 269, Agenda Item 112 (Excerpt) dated 21 March 2011.

UNOFFICIAL TRANSLATION

This text is an unofficial translation of the Dutch original. In case of any discrepancies, the Dutch original shall prevail.

Exhibit	Description
Background	
RF-G2	Witness Statement of Dmitri Gololobov dated 26 July 2016.
DG-001	RTT Certificate of Registration dated 24 September 1992.
DG-002	RTT Joint Venture Charter dated 8 December 1997.
DG-003	List of RTT Employees dated 1 September 1995.
DG-004	Loans for Shares Auction Minutes No. 1 dated 8 December 1995.
DG-005	Loans for Shares Auction Minutes No. 2 dated 8 December 1995.
DG-006	Pledge Agreement No. 0I-2-2761 dated 13 December 1995.
DG-007	Stock Purchase Agreement No. 1-12-1-990 dated 14 December 1995.
DG-008	Stock Purchase Agreement L/A-1 dated 24 January 1996.
DG-009	Stock Purchase Agreement L/T-1 dated 24 January 1996.
DG-010	Stock Purchase Agreement No. U-51/97 dated 5 May 1997.
DG-011	Stock Purchase Agreement Ts-703 dated 24 December 1996.
DG-012	Stock Purchase Agreement No. Y-52/97 dated 5 May 1997.
DG-013	Stock Purchase Agreement No. 8 KA-KI/1 dated 24 March 1998.
DG-014	Stock Purchase Agreement No. 8 EB-TE/1 dated 24 March 1998.
DG-015	Stock Purchase Agreement No. 8 AV-CA/1 dated 24 March 1998.
DG-016	Stock Purchase Agreement No. 8 ME-WA/1 dated 24 March 1998.
DG-017	Stock Purchase Agreement No. 8 NA-VA/1 dated 24 March 1998.
DG-018	Stock Purchase Agreement No. DK-1012/98 dated 17 June 1998.
DG-019	Sale Agreement between Kincaid and Hulley dated 9 March 2000.
DG-020	Sale Agreement between Temerain and Hulley dated 9 March 2000.
DG-021	Sale Agreement between Cayard and Hulley dated 9 March 2000.
DG-022	Sale Agreement between Wandsworth and Hulley dated 9 March 2000.
DG-023	Sale Agreement between Barion and Hulley dated 9 March 2000.
DG-024	Letter from Mr. Muravlenko to Mr. Chubais dated 27 September 1995.
DG-025	Report re: Sale of Yukos Stock from Bank Menatep to Monblan dated 24 December 1996.
DG-026	Mr. P.N. Maly's Memorandum to Mr. O.V. Sheyko dated 14 May 2002.
DG-027	Complete Registry of Shares for OAO Yukos Oil Company dated 22 April 1996.
DG-028	Presidential Decree No. 889 dated 31 August 1995.
DG-029	State Property Committee's Order No. 1458-R dated 10 October 1995.
DG-030	Civil Code of the Russian Federation (CCRF) (Updated) dated 3 January 2006.
DG-031	Resolution of the State Duma of the Russian Federation No. 3331-II GD dated 4 December 1998.
DG-032	S. Lukianov, "Managed' Yukos Sale Fetches \$160M', <i>Moscow Times</i> 24 December 1996.
DG-033	Updated Schedule (ADR Listing) for "Project Voyage" dated 7 August 2002.
DG-034	Project "Voyage" Working Group List dated 4 November 2002.
DG-035	Business Proposal: "Project Voyage" dated 8 August 2002.
DG-036	Restated Compensation Agreement dated 1 November 2002.
DG-037	Email from Bruce Misamore to Dmitry Gololobov dated 27 November 2002.
DG-038	Email from Daniel Walsh to Doug Miller dated 19 September 2002.
DG-039	Memo re: Veteran Managers' Plan and Agreement dated 14 August 2002.
DG-040	Email from Mr. Khodorkovsky to Mr. Sheyko dated 20 February 2003.

UNOFFICIAL TRANSLATION

This text is an unofficial translation of the Dutch original. In case of any discrepancies, the Dutch original shall prevail.

Exhibit	Description
DG-041	Draft F-1 Statement dated 19 March 2003.
DG-042	D. Skorobogatko, D. Butrin, 'The Best Defence Is Non-Ownership', <i>Kommersant</i> 13 January 2005.
DG-043	Clifford Chance Memo 1-90646-06.
DG-044	U.S. Securities and Exchange Commission, EDGAR Search Results for YUKOS OIL CO CIK# 0001223005.
DG-045	<i>Yukos Review</i> , Issue 13(2) dated June 2003.
DG-046	Email attaching Conclusion on Wages Remuneration dated 14 April 2000.
DG-047	Interview with Mikhail Khodorkovsky, <i>Spiegel</i> 9 August 2010.
DG-048	Dmitry Gololobov and Svetlana Bakhmina, 'Perevenutaya Stranitsa', <i>Vedomosti</i> 19 August 2010.
DG-049	F -6 Statement dated 17 March 2003.
DG-050	Curriculum Vitae of Dmitry Gololobov.
DG-051	Letter from West Deutsche Landesbank to Mr. Mikhail Khodorkovsky dated 24 June 1999.
DG-052	Letter from Mr. Alexey Golubovich to West Deutsche Landesbank dated 1 July 1999.
DG-053	A.S. Cullison, 'Vanishing Act: How Oil Giant Yukos Came to Resemble an Empty Cupboard', <i>The Wall Street Journal</i> 15 July 1999.
DG-054	A.S. Cullison, 'Yukos Quietly Transfers Two Oil Assets Out of Russia', <i>The Wall Street Journal</i> 4 June 1999.
DG-055	OAO Yuganskneftegaz Board of Directors, Materials for the Board Meeting dated 26 February 1999.
DG-056	Minutes No. 1, Extraordinary Shareholders Meeting OAO Samaraneftgaz dated 23 March 1999.
DG-057	Minutes of the Meeting of the Board of Directors of OAO Tomskneft dated 25 February 1999.
DG-058	Press Release, Misoki Enterprises Limited, Major Russia Assets are Seized Illegally dated 30 March 1999.
DG-059	Dart sells his shares in units of YUKOS dated 20 December 1999.
DG-060	Dow Jones Newswires (Redactie), 'Russia Seeks to Liquidate Menatep, Appoints Temporary Bank Adviser', <i>The Wall Street Journal</i> 20 May 1999.
DG-061	C. Belton, 'Menatep Creditors Vote to Close Bank', <i>The Moscow Times</i> 22 September 1999.
DG-062	M. Reynolds, 'An "Oligarch's" U-Turn Toward Probity', <i>Los Angeles Times</i> 26 December 2001.
DG-063	'Menatep Papers Sink', <i>The Moscow Times</i> 18 May 1999.
DG-064	S. Tavernise, 'Fortune in Hand, Russia Tries to Polish Image', <i>The New York Times</i> 18 August 2001.
DG-065	'No Traces Will Be Left Behind: Menatep's Documents Lie at the Bottom of the Dubna', <i>Kommersant</i> 29 May 1999.
DG-066	Mikhail Khodorkovsky Facebook Post dated 26 March 2016.
DG-067	S. Pirani, 'Making the grade for investment', <i>Financial News</i> 18 November 2002.

UNOFFICIAL TRANSLATION

This text is an unofficial translation of the Dutch original. In case of any discrepancies, the Dutch original shall prevail.

Exhibit	Description
DG-068	Memo from P.N. Maliy to Oleg Sheiko dated 30 July 2002.
DG-069	Memo from P.N. Maliy to Oleg Sheiko dated 14 May 2012.
DG-070	Email from M.B. Khodorkovsky to S.N. Gorkov and O.V. Sheiko dated 14 May 2012.
DG-071	Chart Showing Moscow Food Factory Ownership.
DG-072	D. Gololobov, 'General Obvious: Did Khodorkovsky steal YUKOS?' dated 28 March 2016.
DG-073	P. Finn, 'Ex-Yukos Executive Calls Russian Probe "Retaliation"', <i>The Washington Post</i> 23 August 2016.
DG-074	'Slovakia buys back oil pipeline firm Transpetrol', <i>Reuters</i> 26 March 2009.
DG-075	B. James, 'Dutch Ruling Hands Yukos Creditor Moravel \$848M', <i>Law360</i> 27 March 2008.
DG-076	C. Belton, 'Court Declares Menatep Bankrupt', <i>The Moscow Times</i> 30 September 1999.
DG-077	GML 2011 Agreement dated June 2011.
DG-078	<i>Yukos Capital SaRL v. Feldman</i> , No. 15-cv-4964-LAK, Amended Complaint dated 15 March 2016.
DG-079	<i>Yukos Capital SaRL v. Feldman</i> , No. 15-cv-4964-LAK, Second Amended Counterclaims, and Third-Party Complaint dated 24 March 2016.
DG-080	BNP Paribas v. Yukos - Dutch Judgment dated 19 September 2005.
DG-081	English Judgment in BNP Paribas v. Yukos Oil Company dated 29 September 2005.
DG-082	2002 Yukos Annual Report
DG-083	Corporate Governance Charter of AO Yukos, OAO NK YUKOS, Resolution of the Board of Directors on Good Corporate Governance dated 3 June 2000.
DG-084	Stichting YI Board Meeting Minutes (ECF No 62-7 in Case 1:15-cv-04964-LAK) dated 18 March 2008.
DG-085	Stichting FPH Board Meeting Minutes (ECF No 62-5 in Case 1:15-cv-04964-LAK) dated 11 December 2008.
DG-086	B. Balogova, 'Transpetrol Shares Return to Slovakia', <i>The Slovak Spectator</i> 6 April 2009.
DG-087	Directive 154 7-R of the State Property Committee dated 25 October 1995.
DG-088	Note by Golubovich re: "Negotiations" with Yukos Managers in October dated 2 November 1995.
DG-089	Bank Statements of Yukos Universal Ltd. 2002-2003.
DG-090	Email from Bruce Bean to Andrei Dontsov re YUL- Tempo Agreement dated 15 August 2002.
DG-091	Original Agreement between Yukos Universal Ltd. and Group Menatep re: Tempo Finance dated 26 March 2002.
DG-092	Certification of Fulfilment of Investment Program by Viktor Kazakov dated 16 December 1998.
DG-093	Laguna's Investment Program 1995.
DG-094	Agreements with Yukos Managers' Shell Companies 1996-1998.

UNOFFICIAL TRANSLATION

This text is an unofficial translation of the Dutch original. In case of any discrepancies, the Dutch original shall prevail.

Exhibit	Description
DG-095	Schedule 1 to the Agreement of March 26, 2002 between Group Menatep Limited and Beneficiaries and Company Temp Finance Ltd dated 26 March 2002.
DG-096	Clifford Chance Emails re: Muravlenko dated 30 September 2002.
DG-097	Eric Wolf Email Copying Leonid Nevzlin dated 28 September 2015
DG-098	Eric Wolf Email to Tim Osborne dated 23 June 2015.
DG-099	Regulation on Investment Tenders for the Sale of Shares of the Yukos Oil Co. OJSC dated 15 December 1994.
DG-100	Letters of Approval from the Ministry on Antimonopoly Policy dated 17 December 1998.
DG-101	Contract No. 001-Yu-R between ZAO Rosprom and OAO Yukos Oil Company dated 20 February 1997.
DG-102	Contract between OAO Yuganskneftegaz and ZAO Yukos EP dated 23 September 1998.
DG-103	Contract between OAO Samaraneftgaz and ZAO Yukos EP dated 23 September 1998.
DG-104	Contract between OAO Tomskneft and ZAO Yukos EP dated 29 September 1998.
DG-105	Contract between OAO Samaraneftgaz and OAO Yukos Oil Company dated 7 July 1998.
DG-106	Protocol No. 1 of Extraordinary Shareholders Meeting of OAO Yuganskneftegaz dated 20 March 1999.
DG-107	Table of Yukos Guarantees dated 1 January 2001.
DG-108	Notices re: Yukos Guarantees.
DG-109	Minutes of Meeting re: Bank Menatep Assets and Liabilities dated 31 May 2000.
DG-110	Yukos Financial Statement dated 24 May 2002.
DG-111	Letter from PricewaterhouseCoopers dated 10 April 2003.
DG-112	Email from Chris Santis to Doug Miller dated 14 February 2005.
DG-113	Maruev Scheme dated 4 December 2000.
DG-114	Letter from Mr. Gololobov to Chief Bailiff A.T. Melnikov dated 6 August 2004.
DG-115	Letter from Mr. Sazanov, Deputy Head of the Bailiffs Department to Mr. Gololobov dated 9 September 2004.
RF-G3	Witness Statement of Yevgeny L. Rybin dated 24 November 2017 with Annexes on the USB stick.
YLR-01	Russian Fund of Federal Property Protocol No. 8052 dated 8 December 1997.
YLR-02	M. Puchkov, 'New Oil Giant is Created', <i>Kommersant</i> 9 December 1997 No. 213.
YLR-03	A. Belyaev, 'Khodorkovsky and Berezovsky Are Looking for a Third One', <i>Kommersant</i> 18 December 1997 No. 218.
YLR-04	Share Exchange Agreement No. 772/98 between Eastern Oil and Sagiman Holding Limited dated 6 November 1998.
YLR-05	Share Exchange Agreement No. 773/98 between Eastern Oil and Montekito Holding Limited dated 6 November 1998.
YLR-06	Share Exchange Agreement No. 774/98 between Eastern Oil and Chellita Limited dated 6 November 1998.

UNOFFICIAL TRANSLATION

This text is an unofficial translation of the Dutch original. In case of any discrepancies, the Dutch original shall prevail.

Exhibit	Description
YLR-09	O. Lurie, 'Festive 'Order'', <i>Sovershenno Sekretno</i> , 1 March 1999 No. 3/119.
YLR-10	Y. Latynina, 'Mikhail Khodorkovsky: Chemistry and Life', <i>Sovershenno Sekretno</i> 1 August 1999 No. 8/124.
YLR-11	A. Baranov, 'Oil of Russia: Is there gunpowder in the powder flasks? The Second Biggest Oil Holding of Russia Activates its Operations', <i>Company's Business</i> November 1999-11.
YLR-12	Judgement in Criminal Case No. 2/350-2000 dated 13 November 2000.
YLR-13	K. Yacheistov, 'There is no MENATEP Any More. But its brand will live for a while', <i>Kommersant</i> 9 December 2002 No. 223.
YLR-14	<i>The Court Convicted A Former Employee Of The Security Service of The Yukos Oil Company</i> , A. Pichugin, General Prosecutor's Office Press Release dated 17 August 2006.
YLR-15	<i>Ex-Yukos Employee A. Pichugin Convicted for 24 Years</i> , <i>Vremya Novostey</i> , Edition No. 148 dated 18 August 2006.
YLR-16	'The Court Found Alexey Pichugin Guilty of Murder', <i>Kommersant</i> 6 August 2007.
YLR-17	E. Zapodinskaya, 'YUKOS Reached the Top Punishment. Leonid Nevzlin received a life sentence, Mikhail Khodorkovsky Faces a Threat of Accusation of Murders', <i>Kommersant</i> 2 August 2008.
YLR-18	Decision on Terminating Proceedings in Criminal Case No. 1-23/10 dated 27 December 2010.
Article 1(6) and 1(7) ECT	
RF-G4	Witness Statement of S.A. Mikhailov dated 24 November 2017.
RF-G5	Witness Statement of Achilles Achilleos dated 17 November 2017 with Annexes on the USB stick.
Exhibit 1	The listing for Hulley's registered office in the Cypriot Registrar of Companies.
Exhibit 2	Photo of the front entrance to the building.
Exhibit 3	Photo of a sign outside the front entrance to the building, which identifies the occupant of office 301 as DCWI.T. Consulting Limited.
Exhibit 4	Photo of a sign inside the building on the ground floor which identifies the occupant of office 301 as AccordServe Business Services.
Exhibit 5	Photo of a sign on the third floor, at the entrance of office 301, for AccordServe Business Services Reception.
Exhibit 6	Open Corporates - Hulley's registered office address.
Exhibit 7	IPAC website Accordserve Business Services Ltd.

UNOFFICIAL TRANSLATION

This text is an unofficial translation of the Dutch original. In case of any discrepancies, the Dutch original shall prevail.

XIV. OVERVIEW OF EXHIBITS

WRIT	
Exhibit	Description
RF-1.	Interim Awards On Jurisdiction And Admissibility, 30 November 2009 in (i) PCA Case No. 226 <i>Hulley Enterprises Limited v. The Russian Federation</i> (ii) PCA Case No. 227 <i>Yukos Universal Limited v. The Russian Federation</i> (iii) PCA Case No. 228 <i>Veteran Petroleum Limited v. The Russian Federation</i> .
RF-2.	Final Awards, 18 July 2014 in (i) PCA Case No. 226 <i>Hulley Enterprises Limited v. The Russian Federation</i> (ii) PCA Case No. 227 <i>Yukos Universal Limited v. The Russian Federation</i> (iii) PCA Case No. 228 <i>Veteran Petroleum Limited v. The Russian Federation</i> .
RF-3.	Case file of (i) PCA Case No. 226 <i>Hulley Enterprises Limited v. The Russian Federation</i> (ii) PCA Case No. 227 <i>Yukos Universal Limited v. The Russian Federation</i> (iii) PCA Case No. 228 <i>Veteran Petroleum Limited v. The Russian Federation</i> .
RF-4.	<i>Khodorkovskiy and Lebedev v. Russia</i> , ECtHR, Appls. Nos. 11082/06 and 13772/05, Judgment dated 25 July 2013.
RF-5.	Communication from the EC Commission on European Energy Charter, COM(91) 36 dated 14 February 1991.
RF-6.	<i>Occidental Petroleum Corp. v. Republic of Ecuador</i> , ICSID Case No. ARB/06/11, Award dated 5 October 2012.
RF-7.	Electronic Registration Card for draft Law No. 96043844-2 on Ratification of the Energy Charter Treaty and the Protocol to the Energy Charter on Energy Efficiency and Related Environmental Aspects.
RF-8.	J. Doré, "The Negotiating History of the European Energy Charter Treaty", in: T.W. Wälde & K.M. Christie (red.), <i>Energy Charter Treaty: Selected Topics</i> Dundee: Centre for Petroleum and Mineral Law and Policy 1995.
RF-9.	United Nations, General Assembly, Statement by the Hellenic Republic during meeting of the Sixth Committee dated 4 November 2013.
RF-10.	United Nations, General Assembly, Statement by the United Kingdom of Great Britain and Northern Ireland during meeting of the Sixth Committee dated 6 November 2012.
RF-11.	United Nations, General Assembly, Statement by New Zealand during meeting of the Sixth Committee dated 4 November 2013.
RF-12.	United Nations, General Assembly, Statement by the Federal Republic of Germany during meeting of the Sixth Committee dated 5 November 2012.
RF-13.	United Nations, General Assembly, Written Statement by the Kingdom of the Netherlands during meeting of the Sixth Committee dated 5 November 2012.
RF-14.	1995 Food Aid Convention, Art. XIX.
RF-15.	1962 Protocol Relating to the Provisional Application of the Protocol Concerning the Establishment of European Schools, Sole Article.
RF-16.	1949 General Agreement on Privileges and Immunities of the Council of Europe.
RF-17.	1964 Convention on the Elaboration of a European Pharmacopoeia.

UNOFFICIAL TRANSLATION

This text is an unofficial translation of the Dutch original. In case of any discrepancies, the Dutch original shall prevail.

Exhibit	Description
RF-18.	1954 Agreement Concerning the International Institute of Refrigeration Replacing the Convention of 21 st June 1920 as modified on 31 st May 1937.
RF-19.	1921 Agreement Between the Government of the French Republic and the Government of the Republic of Czechoslovakia on the Settlement of Questions of Properties, Rights And Interests of Their Nationals in Their Respective Countries.
RF-20.	2008 Economic Partnership Agreement between CARIFORUM States, of the One Part, and the European Community and Its Member States, of the Other Part.
RF-21.	M.H. Arsanjani and W.M. Reisman, Provisional Application of Treaties in International Law: The Energy Charter Treaty Awards, in <i>The Law of Treaties Beyond the Vienna Convention</i> (2011).
RF-22.	United Nations, General Assembly, Statement by China during meeting of the Sixth Committee dated 5 November 2013.
RF-23.	United Nations, General Assembly, Statement by Austria during meeting of the Sixth Committee dated 4 November 2013.
RF-24.	United Nations, General Assembly, Statement by the Kingdom of Belgium during meeting of the Sixth Committee dated 5 November 2013.
RF-25.	United Nations, General Assembly, Statement by Chile during meeting of the Sixth Committee dated 4 November 2013.
RF-26.	United Nations, General Assembly, Statement by South Africa during meeting of the Sixth Committee dated 5 November 2012.
RF-27.	R. Lefeber, "The Provisional Application Of Treaties", in: J. Klabbers & R. Lefeber (eds.) <i>Essays On The Law Of Treaties: A Collection Of Essays In Honour Of Bert Vierdag</i> Utrecht: Martinus Nijhoff Publishers 1998.
RF-28.	H. Krieger, "Article 25: Provisional Application", in: O. Dörr & K. Schmalenbach (red.), <i>Vienna Convention On The Law Of Treaties: A Commentary</i> , New York: Springer 2012.
RF-29.	Auswärtiges Amt, Richtlinien für die Behandlung völkerrechtlicher Verträge – Entwurf 2014 (German Federal Foreign Office, Guidelines on the Treatment of International Treaties – Draft 2014).
RF-30.	Auswärtiges Amt, Richtlinien für die Behandlung völkerrechtlicher Verträge – Neufassung 2004 (German Federal Foreign Office, Guidelines on the Treatment of International Treaties – New Version 2004).
RF-31.	Finnish Government Proposal to the Parliament regarding the ratification of the ECT.
RF-32.	Finnish Ministry of Foreign Affairs Memorandum dated 22 November 1994.
RF-33.	European Commission, Communication from the Commission to the Council and the European Parliament on the signing and provisional application by the European Communities of the European Energy Charter Treaty dated 21 September 1994, Annex.
RF-34.	Council Decision of July 13, 1998 approving the text of the amendment to the trade-related provisions of the Energy Charter Treaty and its provisional application agreed by the Energy Charter Conference and the International Conference of the Signatories of the Energy Charter Treaty, 98/537/EC, L 252/21.
RF-35.	P. Eeckhout, <i>External Relations Of The European Union – Legal And Constitutional Foundations</i> (2004).
Exhibit	Description
RF-36.	ECJ, Ruling 1/78 delivered pursuant to the third paragraph of Article 103 of the EAEC Treaty dated 14 November 1978.
RF-37.	Hermes International v. FHT Marketing, ECJ Case C-53/96, Opinion of Advocate

UNOFFICIAL TRANSLATION

This text is an unofficial translation of the Dutch original. In case of any discrepancies, the Dutch original shall prevail.

	General Tesauro, [1998] ECR I-3603.
RF-38.	C. S. Bamberger, "Epilogue", in: T. Wälde (red.), <i>The Energy Charter Treaty as a Work in Progress, reprinted in The Energy Charter Treaty – An East-West Gateway for Investment and Trade</i> , Alphen aan den Rijn: Kluwer Law International 1996.
RF-39.	1976 Arbitration Rules of the United Nations Commission on International Trade Law.
RF-40.	Rules of Procedure of the Provisional Energy Charter Conference of February 28, 1996 (CC 53 Corr. 2) zoals geciteerd in Decision of the Energy Charter Conference of November 22-23, 1995 (CCDEC 1995 30 GEN).
RF-41.	Rules of Procedure of the Provisional Energy Charter Conference of February 28, 1996 (CC 53 Corr. 2) as cited in Decision of the Energy Charter Conference of November 22-23, 1995 (CCDEC 1995 30 GEN).
RF-42.	Energy Charter Treaty Website, "Members and Observers"™.
RF-43.	Decision of the Energy Charter Conference of December 6, 2013 (CCDEC 2013 24 APP).
RF-44.	L.A. Okunkov (ed.), Commentary to Constitution of the Russian Federation (Article-By-Article) (1996).
RF-45.	Y.A. Dmitriev, The Constitution Of The Russian Federation. Doctrinal Commentary (ed. 2013).
RF-46.	E.Y. Barkhatova, Commentary re Constitution of the Russian Federation (2010).
RF-47.	1995 Law On International Treaties dated 15 July 1995.
RF-48.	Federal laws on ratification of BITs by the State Duma.
RF-49.	Resolution No. 8-P of the Constitutional Court dated 27 March 2012.
RF-50.	Expert Report of Professor Anton V. Asoskov (with Annexes), dated October 30, 2014.
RF-51.	1990 Agreement Between the Government of the People's Republic of China and the Government of the Union of Soviet Socialist Republics Concerning the Promotion and Reciprocal Protection of Investments.
RF-52.	1989 Agreement Between the Kingdom of Belgium and the Grand Duchy of Luxembourg and the Government of the Union of Soviet Socialist Republics Concerning the Promotion and Reciprocal Protection of Investments.
RF-53.	1989 Agreement Between the Government of Finland and the Government of the Union of Soviet Socialist Republics Concerning the Promotion and Reciprocal Protection of Investments.
RF-54.	1989 Agreement Between the Government of the Republic of Italy and the Government of the Union of Soviet Socialist Republics Concerning the Promotion and Reciprocal Protection of Investments.
RF-55.	1990 Agreement Between the Government of the Kingdom of Spain and the Government of the Union of Soviet Socialist Republics Concerning the Promotion and Reciprocal Protection of Investments.
Exhibit	Description
RF-56.	1990 Agreement Between the Government of the Republic of Austria and the Government of the Union of Soviet Socialist Republics Regarding the Promotion and Reciprocal Protection of Investments.
RF-57.	1989 Agreement Between the Federal Republic of Germany and the Government of the Union of Soviet Socialist Republics Concerning the Promotion and Reciprocal Protection of Investments.
RF-58.	1990 Agreement Between the Swiss Federal Council and the Government of the Union of Soviet Socialist Republics Concerning the Promotion and Reciprocal Protection of Investments.

UNOFFICIAL TRANSLATION

This text is an unofficial translation of the Dutch original. In case of any discrepancies, the Dutch original shall prevail.

RF-59.	1990 Agreement Between the Government of the Republic of Turkey and the Government of the Union of Soviet Socialist Republics Concerning the Promotion and Reciprocal Protection of Investments.
RF-60.	1990 Agreement Between the Government of the Republic of Korea and the Government of the Union of Soviet Socialist Republics Concerning the Promotion and Reciprocal Protection of Investments.
RF-61.	S. Ripinsky, "Chapter 14: Russia", in C. Brown (red.), <i>Commentaries On Selected Model Investment Treaties</i> , Oxford: Oxford University Press 2013.
RF-62.	Explanatory Note Regarding the Draft Federal Law "On Ratification of the Agreement between the Government of the Russian Federation and the Government of the Republic of Macedonia on Encouragement and Reciprocal Protection of Investments" (30 May 1998).
RF-63.	Explanatory Note on the Issue of Ratification of the Agreement between the Government of the Russian Federation and the Government of the Arab Republic of Egypt on Promotion and Reciprocal Protection of Investments (8 April 2000).
RF-64.	Explanatory Note on the Issue of Ratification of the Agreement between the Government of the Russian Federation and the Government of Japan for the Promotion and Protection of Investments (29 February 2000).
RF-65.	Explanatory Note Regarding the Draft Federal Law "On Ratification of the Bilateral Investment Treaty between the Government of the Russian Federation and the Government of the Syrian Arab Republic" (30 June 2007).
RF-66.	Certified Translation of Explanatory Note to the Draft Law On Ratification of the Energy Charter Treaty originally submitted as C-143.
RF-67.	Radio Free Europe, Former Yukos Official Satisfied With Court Award, (29 July 2014).
RF-68.	Financial Times, Leonid Nevzlin is biggest winner from Yukos ruling at The Hague, (28 July, 2014).
RF-69.	Reuters, Nevzlin 'very pleased' with Hague court ruling on Yukos, (28 July 2014) .
RF-70.	I. Brownlie, <i>Principles Of Public International Law</i> (7 th ed. 2008).
RF-71.	Nasser Esphahanian v. Bank Tejarat, Award No. 31-157-2 of March 29, 1983, 2 IUSCTR 157.
RF-72.	ST-AD GmbH v. Republic of Bulgaria, UNCITRAL, PCA Case No. 2011-06, Award on Jurisdiction dated 18 July 2013.
RF-73.	National Gas S.A.E. v. Arab Republic of Egypt, ICSID Case No. ARB/11/7/, Award dated 3 April 2014 .
RF-74.	TSA Spectrum De Argentina S.A. v. Argentine Republic, ICSID Case No. ARB/05/5, Award dated 19 December 2008.
Exhibit	Description
RF-75.	Competence of Assembly regarding admission to the United Nations, Advisory Opinion of March 3 rd 1950, 1950 I.C.J. Rep., 4.
RF-76.	Judgment of the Svea Court of Appeal, The Russian Federation v. RosInvestCo UK Ltd., Case No. T 10060-10 (5 September 2013).
RF-77.	OECD, Action Plan on Base Erosion and Profit Shifting (19 July 2013).
RF-78.	Garanti Koza LLP v. Turkmenistan, ICSID Case No. ARB/11/20, Decision on the Objection to Jurisdiction for Lack of Consent dated 3 July 2013.
RF-79.	Urbaser S.A. and Consorcio de Aguas Bilbao Biskaia, Bilbao Biskaia Ur Partzuergoa v. Argentine Republic, ICSID Case No. ARB/07/26, Decision on Jurisdiction dated 19 December 2012.
RF-80.	ICS Inspection and Control Services Limited v. The Argentine Republic, Award on Jurisdiction of 10 February 2012.

UNOFFICIAL TRANSLATION

This text is an unofficial translation of the Dutch original. In case of any discrepancies, the Dutch original shall prevail.

RF-81.	Daimler Financial Services AG v. Argentine Republic, ICSID Case No. ARB/05/1, Award of August 22, 2012.
RF-82.	Ambiente Ufficio S.P.A. and Others v. Argentine Republic, ICSID Case No. ARB/08/9, Decision on Jurisdiction and Admissibility of February 8, 2013.
RF-83.	1992 Agreement on Encouragement and Reciprocal Protection of Investments Between the Kingdom of the Netherlands and the Argentine Republic.
RF-84.	Report of the International Law Commission (2006), Suppl. No. 10 (A/61/10).
RF-85.	Expert Report Of Professor James Dow, dated 8 November 2014.
RF-86.	Sergey Ripinsky & Kevin Williams, Damages in International Investment Law, (British Institute of International and Comparative Law 2008).
RF-87.	J. Waincymer, Procedure And Evidence In International Arbitration (2012).
RF-88.	C. Partasides, The Fourth Arbitrator? The Role of Secretaries to Tribunals in International Arbitration, 2002, Kluwer Law International, nummer 2, p. 147-163.
RF-89.	IBA Rules of Ethics for International Arbitrators.
RF-90.	G. Born, International Commercial Arbitration, Alphen aan de Rijn: Kluwer Law International 2014.
RF-91.	UNCITRAL Notes on Organizing Arbitral Proceedings 1996, ¶¶ 26-27.
RF-92.	Note from the Secretariat of the ICC Court Concerning the Appointment of Administrative Secretaries by Arbitral Tribunals 1995; ICC Note on the Appointment, Duties and Remuneration of Administrative Secretaries 2012.
RF-93.	Young ICCA Guide on Arbitral Secretaries.
RF-94.	White & Case, International Arbitration Survey: Current and Preferred Practices in the Arbitral Process, 2012
RF-95.	Redfern, Hunter e.a., Redfern and Hunter on International Arbitration, Oxford University Press, 2009.
STATEMENT OF REPLY	
Background	
RF-96.	Expert report Reinier Kraakman dated 1 April 2011.
RF-97.	Lucy Komisar, Yukos Kingpin on Trial, CorpWatch (10 May2005).
Article 45 ECT	
RF-98.	Robert E. Dalton, Provisional Application Of Treaties, in: Duncan B. Hollis (red.), The Oxford Guide to Treaties, Oxford: Oxford University Press 2012, p. 228-229.
Exhibit	Description
RF-99.	First Report By The Special Rapporteur On The Provisional Application Of Treaties, Sixty-Fifth Session of the International Law Commission, A/CN.4/664 (3 June 2013), § 7.
RF-100.	Ambatielos Case (Greece v. United Kingdom), Preliminary Objection, Judgment (1 July 1952), 1952 I.C.J. Rep. 28, 43.
RF-101.	René Lefeber, Treaties, Provisional Application, in Max Planck Encyclopedia Of Public International Law (2011)).
RF-102.	Report Of The International Law Commission On The Work Of Its Sixty-Third And Sixty-Fourth Session, A/CN.4/657 (18 January 2013), § 42.
RF-103.	Second Report By The Special Rapporteur On The Provisional Application Of Treaties, Sixty-Sixth Session Of The International Law Commission, A/CN.4/675 dated 9 June 2014.
RF-104.	Chapter XXIII, Law of Treaties, Vienna Convention on the Law of Treaties.

UNOFFICIAL TRANSLATION

This text is an unofficial translation of the Dutch original. In case of any discrepancies, the Dutch original shall prevail.

RF-105.	Austrian Government Bill to the Vienna Convention.
RF-106.	Convention For European Economic Cooperation (16 April 1948).
RF-107.	Case Concerning a Dispute between Argentina and Chile Concerning the Beagle Channel, Award (18 February 1977), XXI U.N.R.I.A.A. (2006).
RF-108.	The Republic of Ecuador v. Occidental Exploration & Production Company, Judgment (4 July 2007), [2007] EWCA Civ 656.
RF-109.	Provisional Summary Record Of The 3233 rd Meeting, Sixty-Sixth Session (Second Part) Of The International Law Commission, A/CN.4/SR.3233 dated 10 October 2014.
RF-110.	European Energy Charter Conference Secretariat, Document 8/91 – BP 2, Art. 41 (Sept. 11, 1991).
RF-111.	European Energy Charter Conference Secretariat, Document 21/91 – Annex I – BA 4, Draft (Oct. 31, 1991).
RF-112.	European Energy Charter Conference Secretariat, Document 14/91 – BP 3, (Oct. 11, 1991).
RF-113.	Facsimile van het U.S. Department of State aan het Secretariaat van de Conferentie van het Europese Energiehandveset dated 24 February 1994.
RF-114.	Statement On Behalf Of The European Union By Eglantine Cujo, Legal Adviser, Delegation Of The European Union To The United Nations, At The 68 th United Nations General Assembly Sixth Committee On Agenda Item 81 On Provisional Application Of Treaties (4 November 2013).
RF-115.	Delano Verwey, The European Community, The European Union and the International Law of Treaties (2004).
RF-116.	Case Concerning Rights Of Nationals Of The United States Of America In Morocco (France v. United States of America), Judgment (27 August 1952).
RF-117.	Francis G. Jacobs, Varieties Of Approach To Treaty Interpretation: With Special Reference To The Draft Convention On The Law Of Treaties Before The Vienna Diplomatic Conference, 18 ICLQ (1969).
RF-118.	Sempra Energy International v. The Argentine Republic, ICSID Case No. ARB/02/16, Decision on Objections to Jurisdiction (11 May 2005).
RF-119.	Libananco Holdings Co. Limited v. Republic of Turkey, ICSID Case No. ARB/06/8, Decision on Annulment (22 May 2013).
Exhibit	Description
RF-120.	T.M. Pryakhina, Constitutional Law Status Of International Treaties Of The Russian Federation That Have Not Entered Into Force, 6 Constitutional and Municipal Law (2010).
RF-121.	Anneliese Quast Mertsch, Provisionally Applied Treaties: Their Binding Force And Legal Nature (2012).
RF-122.	Resolution No. 8 of the Plenum of the Supreme Court of the Russian Federation “On Certain Issues of Application by Courts of the Constitution of the Russian Federation in Administering Justice” (31 October 1995).

UNOFFICIAL TRANSLATION

This text is an unofficial translation of the Dutch original. In case of any discrepancies, the Dutch original shall prevail.

RF-123.	Resolution No. 5 of the Plenum of the Supreme Court of the Russian Federation “On Application by Courts of General Jurisdiction of Generally Recognized Principles and Rules of International Law and International Treaties of the Russian Federation” (10 October 2003).
RF-124.	Ruling No. 2531-O of the Constitutional Court of the Russian Federation (6 November 2014).
RF-125.	Cassation Ruling No. 59-O09-35 of the Supreme Court of the Russian Federation (29 December 2009).
RF-126.	D.A. Shlyantsev, Commentary To The Federal Law On International Treaties Of The Russian Federation (Article-By-Article) (2006).
RF-127.	K.A. Bekyashev, International Public Law, Treatise (2001).
RF-128.	N.A. Ageshkina, Academic and Practical Commentary to Federal Law No. 101-Fz “On International Treaties of The Russian Federation” Dated July 15, 1995 (2013).
RF-129.	V.D. Zorkin (red.), Commentary To The Constitution Of The Russian Federation (2 nd Ed. 2011).
RF-130.	S.B. Balkhaeva, Types Of Entry Into Force Of International Treaties Of The Russian Federation, 8 <i>Journal of Russian Law</i> (2011).
RF-131.	Federal Law No. 119-FZ “On Enforcement Proceedings” (21 July 1997).
RF-132.	Arbitrazh Procedure Code of the Russian Federation (2002).
RF-133.	Civil Procedure Code of the Russian Federation (2002).
RF-134.	Facsimile from Mr. Sydney Fremantle to Mr. Charles Rutten (3 August 1994).
RF-135.	Ruling of the Constitutional Court of the Russian Federation No. 5-O (15 January 2015).
RF-136.	1991 Fundamentals of Legislation, Art. 1.
RF-137.	Resolution of the Constitutional Court No. 6-P (31 May 2005).
Article 1(6) and 1(7) ECT	
RF-138.	Nova Scotia Power Incorporated v. Bolivarian Republic of Venezuela, ICSID Case No. ARB(AF)/11/1, Award (30 April 2014).
RF-139.	Alapli Elektrik B.V. v. Republic of Turkey, ICSID Case No. ARB/08/13, Award (16 July 2012).
RF-140.	D. Carreau And P. Juillard, Droit International Economique, Parijs: Dalloz 2013.

UNOFFICIAL TRANSLATION

This text is an unofficial translation of the Dutch original. In case of any discrepancies, the Dutch original shall prevail.

Exhibit	Description
RF-141.	Bruno Poulain, L'investissement international: Définition ou Définitions? in: Thomax W. Wälde and Philippe Kahn (red.), <i>New Aspects of International Investment Law</i> , 2004.
RF-142.	José Enrique Alvarez, <i>The Public International Law Regime Governing International Investment</i> , 344 <i>Collected Courses of the Hague Academy of International Law</i> (2011).
RF-143.	Philip C. Jessup, <i>A Modern Law of Nations: An Introduction</i> , New York: Macmillan 1948.
RF-144.	Barcelona Traction, Light and Power Company, Limited, <i>Separate Opinion of Judge Jessup</i> (5 February 1970, 1970 I.C.J. Rep. 161).
RF-145.	Venoklim Holding B.V. v. Bolivarian Republic of Venezuela, ICSID Case No. ARB/12/22, Award (3 April 2015).
RF-146.	Venezuelan Law on the Promotion and Protection of Investments.
RF-147.	Fraport AG Frankfurt Airport Services Worldwide v. Republic of the Philippines, ICSID Case No. ARB/11/12, Award (10 December 2014).
Article 21 ECT	
RF-148.	Legal Status of Eastern Greenland (Den. v. Nor.), 1933 P.C.I.J. (ser. A/B) No. 53 (5 April 1933).
RF-149.	Anthony Aust, <i>Modern Treaty Law And Practice</i> , Cambridge: Cambridge University Press 2007.
RF-150.	J. Romesh Weeramantry, <i>Treaty Interpretation in Investment Arbitration</i> , Oxford: Oxford University Press 2012.
RF-151.	ConocoPhillips Petrozuata B.V., ConocoPhillips Hamaca B.V. and ConocoPhillips Gulf of Paria B.V. v. Bolivarian Republic of Venezuela, ICSID Case No. ARB/07/30, Award (3 September 2013).
RF-152.	Cargill, Incorporated v. United Mexican States, ICSID Case No. ARB(AF)/05/2, Award (18 September 2009).
RF-153.	R.K. Gardiner, <i>Treaty Interpretation</i> , Oxford: Oxford University Press 2008
RF-154.	Case concerning Oil Platforms (Islamic Republic of Iran v. United States of America), Judgment, 2006 I.C.J. Rep. 225 (6 November 2003), <i>Separate Opinion of Judge Higgins</i> .
RF-155.	K. Pilkov, <i>Evidence in International Arbitration: Criteria for Admission and Evaluation</i> , <i>Arbitration</i> 2014.
RF-156.	Articles on Responsibility of States for Internationally Wrongful Acts with commentaries (Text adopted by the International Law Commission at its fifty-third session, in 2001), <i>Yearbook of the International Law Commission</i> , 2001, vol. II, Part Two.
RF-157.	Draft Articles on Diplomatic Protection (Text adopted by the International Law Commission at its fifty-eight session, in 2006), <i>Yearbook of the International Law Commission</i> , 2006, vol. II, Part Two.

UNOFFICIAL TRANSLATION

This text is an unofficial translation of the Dutch original. In case of any discrepancies, the Dutch original shall prevail.

RF-158.	ILC Commentary on Article 15, Yearbook of the International Law Commission, 2006, vol. II, Part Two.
RF-159.	J. Paulsson, <i>Denial of Justice in International Law</i> , Cambridge: Cambridge University Press 2011.
Exhibit	Description
RF-160.	Abaclat and Others (Case formerly known as Giovanna a Beccara and Others) v. Argentine Republic, ICSID Case No. ARB/07/5, Decision on Jurisdiction and Admissibility (4 August 2011).
Damages and Annex I	
RF-161.	E. Tjong Tjin Tai, Verrassingsbeslissingen door de civiele rechter, <i>NJB</i> 2000.
RF-162.	R. Richardson Pettit, Dividend Announcements, Security Performance, and Capital Market Efficiency, <i>The Journal of Finance</i> 27 (1972).
RF-163.	Steve Schaefer, Apple Slides Despite Huge Profit, Massive Cash Pile: It's All About The iPhone, <i>Forbes.com</i> (21 jli 2015).
RF-164.	Jonathan Berk and Peter De Marzo, <i>Corporate Finance</i> , New York: Pearson 2014
RF-165.	Agustino Fontevicchia, Qualcomm Profit Up 32%, Stock Tanks: First Victim Of Apple Setting The Bar Too High?, <i>Forbes.Com</i> (20 July 2011).
RF-166.	Richard Saintvilus, "Helmerich & Payne Stock Falls on Outlook Despite Earnings Beat," <i>TheStreet</i> (29 January 2015).
RF-167.	Paul Ausick, Pacific Ethanol Faces Tougher Quarter After Beating Q3 Estimates, (29 October 2014).
RF-168.	Krishna Palepu, Et Al., <i>Business Analysis And Valuation: Using Financial Statements</i> , Boston: Cengage 2000.
RF-169.	Zvi Bodie, Alex Kane and Alan Marcus, <i>Investments</i> , New York: Mcgraw-Hill 2005.
RF-170.	David Hillier et al., <i>Corporate Finance 2d European Edition</i> (2013).
RF-171.	Marcus Taylor, A Visual Comparison of Google, Yahoo and Bing's Revenue, Profit, Market Share & More, <i>VentureHarbour</i> , available at https://www.ventureharbour.com/visualising-size-google-bing-yahoo .
RF-172.	Mark Mahaney, GOOG: Far and Away The Best Fundies On The Net, <i>Citigroup</i> dated 21 July 2005.
RF-173.	RTS Oil & Gas Index Daily Constituents and Weights, entry for June 30, 2014, available at http://moex.com/en/index/MICEXO%26G/constituents .
RF-174.	Euronext, <i>Index Rule Book, AEX® Family</i> .
RF-175.	S&P Dow Jones Indices, <i>S&P U.S. Indices Methodology</i> .
RF-176.	Investopedia, "Total Return Index", available at http://www.investopedia.com/terms/t/total_return_index.asp .
Valuation Date	
RF-177.	R. Dolzer en M. Stevens, <i>Bilateral Investment Treaties</i> , Alphen aan den Rijn: Kluwer Law International 1995 .

UNOFFICIAL TRANSLATION

This text is an unofficial translation of the Dutch original. In case of any discrepancies, the Dutch original shall prevail.

RF-178.	Sedco, Inc. and National Iranian Oil Company, et al., Interlocutory Award No. ITL 59-129-3 (Mar. 27, 1986), 10 Iran-U.S. C.T.R. 189, Separate Opinion of Judge Brower.
RF-179.	1975 Agreement between the Government of the United Kingdom of Great Britain and Northern Ireland and the Government of the Arab Republic of Egypt for the Promotion and Protection of Investments.
Exhibit	Description
RF-180.	1993 Agreement between the Hellenic Republic and the Arab Republic of Egypt for the Promotion and Reciprocal Promotion of Investments.
RF-181.	Audley Sheppard, The Distinction between Lawful and Unlawful Expropriation, in INVESTMENT ARBITRATION AND THE ENERGY CHARTER TREATY (Clarisse Ribeiro, ed., 2006).
RF-182.	British Caribbean Bank Limited v. The Government of Belize, UNCITRAL, Award dated 19 December 2014.
RF-183.	Thomas T. Wälde and Borzu Sabahi, Compensation, Damages and Valuation in THE OXFORD HANDBOOK OF INTERNATIONAL INVESTMENT LAW (P. Muchlinski, F. Ortino and C. Schreuer eds., 2008).
RF-184.	1995 Agreement between the Kingdom of Spain and the United Mexican States on the Reciprocal Promotion and Protection of Investments.
RF-185.	Sola Tiles, Inc. and The Government of the Islamic Republic of Iran, Award No. 298-317-1 (22 April 1987), 14 Iran-U.S. C.T.R. 223.
RF-186.	1982 Agreement between the Government of the United Kingdom of Great Britain and Northern Ireland and the Government of Belize for the Promotion and Protection of Investments.
Assistent of the Tribunal	
RF-187.	Overview of news articles on the role of Mr Valasek.
RF-188.	Chronology of Mr Fortier's Appointment as Arbitrator between 21 July 2005 and 18 July 2014.
RF-189.	Expert Report Regarding Authorship of the Final Awards, Carole E. Chaski, Ph.D. including Annexes., dated 11 September 2015.
RF-190.	Fed. R. Evid. 702.
RF-191.	Daubert v. Merrell Dow Pharmaceuticals, Inc, 509 U.S. 579 (1993).
RF-192.	Raskin v. Wyatt Co., 125 F.3d 55, 66 (2d Cir. 1997).
RF-193.	Amorgianos v. Nat'l R.R. Passenger Corp., 303 F.3d 256, 267 (2d Cir. 2002).
RF-194.	Ga. Code Ann. § 24-9-67.1(b)(1)-(3) (f) (effective Feb. 16, 2005 to June 30, 2009).
RF-195.	'Decision on the Proposal to Disqualify a Majority of the Tribunal', dated 1 July 2015, ICSID Case No. ARB/07/30 (incl. Annex B).
RF-196.	S.L. Buruma, 'Capita selecta ter zake van de beslechting van geschillen door de Raad van Arbitrage voor de Bouwbedrijven in Nederland, en andere arbitrage-instituten en de overheidsrechter' in <i>Bouwarbitrage en civiele rechter, preadvies voor de</i>

UNOFFICIAL TRANSLATION

This text is an unofficial translation of the Dutch original. In case of any discrepancies, the Dutch original shall prevail.

	<i>Vereniging voor Bouwrecht</i> , Kluwer:Deventer 1995, p. 79-103, p. 90-95.
RF-197.	H.J. Snijders, 'Rond de arbitrage met name in bouwzaken' in <i>Bouwarbitrage en civiele rechter</i> , preadvies voor de Vereniging voor Bouwrecht, Kluwer:Deventer 1995, p. 3-78.
International Criticism	
RF-198.	OAo Neftyanaya Kompaniya Yukos v. Russia, ECtHR, Appl. No. 14902/04, Judgment (Just Satisfaction) dated 31 July 2014).
RF-199.	The Supreme council of the USSR Resolution, no. 2303-1 on the enactment of fundamentals of legislation on foreign investments in the USSR dated 5 July 1991.
DOCUMENT CONTAINING EXHIBITS (22-1-2016)	
Article 1(6) and 1(7) ECT	
Exhibits	Description
RF-200.	Statement by Gitas Povilo Anilionis dated 16 October 2015.
RF-201.	Statement by Arkady Vitalyevich Zakharov dated 14 October 2015.
RF-202.	Expert Report S.P. Kothari dated 20 October 2015.
RF-203.	Expert Report van Professor Anton V. Asoskov dated 20 October 2015
RF-204.	Iton.TV, Interview van Leonid Nevzlin dated 23 August 2014, 10:45.
RF-205.	Bloomberg, Yukos Owners Win \$50 Billion in 10-Year Fight With Russia, 28 July 2014.
RF-206.	<i>Hulley Enterprises Ltd, Yukos Universal Ltd and Vetal Petroleum Ltd v. The Russian Federation</i> , District Court of Columbia, Case No. 1:14-cv-01996-ABJ, Motion to deny confirmation of Arbitration Awards pursuant to New York Convention, 20 October 2015.
RF-207.	<i>A.J. van den Berg, 'The Role of Dissenting Opinions, Tokios Tokelès v. Ukraine, ICSID Case No. ARB/02/18, Dissenting Opinion of Prosper Weil', Building International Investment Law; The First 50 Years of ICSID, p. 585 e.v.</i>
Article 21(5) ECT	
RF-208.	<i>S. Nappert, 'The Yukos Awards - A Comment', The Journal of Damages in International Arbitration, Vol. 2, 2015, No. 2.</i>
RF-209.	<i>S. Nappert, 'Square Pegs and Round Holes: The Taxation Provision of the Energy Charter Treaty and the Yukos Awards', in: Cahiers de l'arbitrage, 1 January 2015, no. 1, p. 7 e.v.</i>
Damages	
RF-210.	P. Bienvenu & M.J. Valasek, 'Compensation for Unlawful Expropriation, and Other Recent Manifestations of the Principle of Full Reparation in International Investment Law', in A.J. van den Berg (red.), 50 Years of the New York Convention: ICCA International Arbitration Conference, ICCA Congress Series, 2009 Dublin Volume 14 (Kluwer Law International 2009) pp. 231-281.
RF-211.	Cour d'Appel de Paris, nr. 08/23901, Commercial Caribbean Niquel v. Overseas Mining Investments Ltd. dated 25 March 2010.
RF-212.	Cour de Cassation, Eerste Civiele Kamer, arrest nr. 785, Overseas Mining Investments Ltd v. Commercial Caribbean Niquel dated 29 June 2011.
RF-213.	Court of Cassation confirms setting aside of award for lack of due process where a tribunal had based its finding on a principle of law not discussed during the hearing dated 13 July 2011, (http://hsfnotes.com/arbitration/2011/07/13/court-of-cassation-confirms-setting-aside-of-award-for-lack-of-due-process-where-a-tribunal-had-based-its-finding-on-a-

UNOFFICIAL TRANSLATION

This text is an unofficial translation of the Dutch original. In case of any discrepancies, the Dutch original shall prevail.

	principle-of-law-not-discussed-during-the-hearing..- geraadpleegd op 3 July 2015).
RF-214.	Kathleen Paisley, Yukos v. Russian Federation, powerpoint presentatie voor Juris Damages Conferentie in Wenen dated 2 October 2015.
Assistent to the Tribunal	
RF-215.	Expert Report Carole E. Chaski, Ph.D., 13 January 2016, inclusief: <ul style="list-style-type: none"> • bijlage CHA-22; en • bijlage CHA-23.
RF-216.	A. Ross, 'BLP puts secretaries under scrutiny', Global Arbitration Review, 6 January 2016 (www.globalarbitrationreview.com – geraadpleegd op 7 jan. 2016).
Exhibits	Description
RF-217.	BLP International Arbitration; Research based report on the use of tribunal secretaries in international commercial arbitration, Survey 2015.
Background	
RF-218.	Russian Federation v GBI 9000 SIVA S.A., ALOS 34 S.L., Orgor de Valores SICAV S.A. and Quasar de Valors SICAV S.A., Svea Court of Appeal, Case No. T9128-14, dated 18 January 2016.
RF-219.	Occidental Petroleum Corporation and Occidental Exploration and Production Company v The Republic of Ecuador, ICSID Case No. ARB/06/11, Award dated 5 October 2012 (first page only) and Decision on Annulment of the Award, 2 November 2015.
RF-220.	Fraport AG Frankfurt Airport Services Worldwide v The Republic of the Philippines, ICSID Case No. ARB/03/25, Award dated 16 August 2007 (first page only) and Decision on the Application for Annulment of Fraport AG Frankfurt Airport Services Worldwide, 23 December 2010.
RF-221.	F. Mulder, E. Schrtam & Adriana Homolova, 'Grote David tegen kleine Goliath; ISDS. Investeerders dagen overheden', De Groene Amsterdammer, 25 November 2015, week 48.
RF-222.	Getuigenverklaring van A.G. Burutin dated 15 January 2016.
SUPPLEMENTARY DOCUMENT CONTAINING EXHIBITS (25-1-2016)	
RF-223.	'Swedish court rules Paulsson tribunal should not have heard Yukos claims...', Global Arbitration Review, 22 January 2016 (www.globalarbitrationreview.com – geraadpleegd op 22 January 2016).
RF-224.	Expert Report Professor Pierre Lalive dated 16 July 2010.
RF-225.	USB-stick with documents as stated on page 35 and onwards of the Expert Opinion of prof. A.V. Asoskov dated 20 October 2015 (RF-203) and Annex R-0055 as stated in the report of Mr. Kothari (RF-202).
SUPPLEMENTARY DOCUMENT CONTAINING EXHIBITS (27-1-2016)	
RF-225	Replacement USB-stick (as partially already submitted on 25 January 2016 in relation to the Asoskov annexes) with files that are referred to in the following exhibits submitted earlier (on 22 January 2016): RF-200 (Anilionis) RF-201 (Zakharov) RF-202 (Kothari) RF-203 (Asoskov)
RF-226	Letter from S.V. Muravlenko, dated 27 September 1995.

UNOFFICIAL TRANSLATION

This text is an unofficial translation of the Dutch original. In case of any discrepancies, the Dutch original shall prevail.

DEFENCE ON APPEAL	
Article 45 ECT	
Exhibits	Description
RF-227	M. Polkinghorn en L. Gouiffes, <i>Provisional application of the Energy Charter Treaty: the conundrum</i> , in: Graham Coop (ed.) <i>Energy Dispute Resolution: Investment Protection, Transit and the Energy Charter Treaty</i> , 2011.
RF-228	Fax from Weis to Hungary, Romania and Norway regarding the provisional application dated 18 January 1993.
RF-229	Fax from Weis to Tanja, Houttuin en Young on alternative wordings dated 10 January 1994.
RF-230	S. Pritzkow, <i>Das völkerrechtliche Verhältnis zwischen der EU und Russland im Energiesektor</i> , Springer, 2011.
RF-231	Ministry of Economic Affairs, Memo: State of affairs regarding CT articles which have not been addressed yet dated 13 August 1993.
RF-232	T. Gazzini, 'Yukos Universal Limited (Isle of Man) v. The Russian Federation, Provisional Application of the ECT in the Yukos Case', <i>ICSID Review</i> 2015, Vol. 30/2.
RF-233	T. Gazzini, <i>Interpretation of International Treaties</i> , Chapter 4, Hart Publishing 2016.
RF-234	European Energy Charter Conference Secretariat, 6/91, CONF 4 Restricted Note from Secretariat (United States).
RF-235	Fax from Italy to the European Energy Conference Secretariat, regarding inclusion of Italy in Annex PA dated 27 July 1994.
RF-236	European Energy Charter, Room doc. 15, remarks of the Japanese delegation to Article 45 ECT dated 8 March 1994.
RF-237	Memorandum of Pierson to Steeg regarding European Energy Charter Treaty Negotiations dated 20 December 1993.
RF-238	Memorandum from Bamberger to Steeg and Ferriter regarding European Energy Charter Plenary of 7-11 March, dated 15 March 1994.
RF-239	Fax from Bamberger to Weis regarding Clive's Draft Memo on Provisional Application dated 10 November 1994.
RF-240	Letter from Weis to Jones dated 21 October 1994.
RF-241	Letter from Jones (ECT Secretariat) to Shatalov (Deputy Minister of the Ministry of Fuel and Energy of the Russian Federation) dated 20 October 1994.
RF-242	Letter from Ivanov (Deputy Minister of the Ministry of Foreign Affairs of the Russian Federation) to Shatalov (Deputy Minister of the Ministry of Fuel and Energy of the Russian Federation) dated 30 March 1995.
RF-243	Letter from Sorokin (ECT Secretariat) to Shatalov (Minister of the Russian Federation) dated 17 May 1995.
RF-244	Approval of the Russian translation of the ECT Treaty dated 1 June 1995.
RF-245	Memorandum of the ECT Secretariat on the final text of the Treaty dated 29 June 1995.
RF-246	Letter from Sorokin (ECT Secretariat) to Shatalov (Deputy Minister of the Ministry of Fuel and Energy of the Russian Federation) about the authenticity of the translation dated 28 August 1995.
RF-247	Union Européenne le conseil, Projet de Procès-Verbal, (session 1817) dated 19 January 1994.
RF-248	Union Européenne le conseil, Addendum 1 a la liste des points a dated 15-16 December 1994.
RF-249	Fax from Weis to Bamberger regarding provisional application dated 10 November

UNOFFICIAL TRANSLATION

This text is an unofficial translation of the Dutch original. In case of any discrepancies, the Dutch original shall prevail.

	1994.
RF-250	Y. Banifatemi, <i>Provisional application of the Energy Charter Treaty: the negotiation history of Article 45</i> , in: Graham Coop (ed.) <i>Energy Dispute Resolution: Investment Protection, Transit and the Energy Charter Treaty</i> , 2011.
RF-251	J. Crawford, <i>Introductory Remarks</i> , in: Graham Coop (ed.) <i>Energy Dispute Resolution: Investment Protection, Transit and the Energy Charter Treaty</i> , 2011.
RF-252	U. Klaus, 'The Gate to Arbitration, The Yukos Case and the Provisional Application of the Energy Charter Treaty in the Russian Federation', <i>Transnational Dispute Management</i> 2005, Vol 2(3).
RF-253	T. Roe en M. Happold, <i>Settlement of Investment Disputes under the Energy Charter Treaty</i> , Cambridge University Press 2011.
RF-254	Letter regarding the signing of the Treaty by the Kingdom of the Netherlands dated 13 December 1994.
RF-255	Letter from Larson (USA) to Rutten (Chairman) dated 28 July 1994.
RF-256	Letter from Fremantle to Rutten (Chairman) on the sovereignty of the United States of America regarding tax disputes dated 2 August 1994.
RF-257	Fax from Larson (USA) to Rutten (Chairman) dated 2 September 1994.
RF-258	Letter from Donnaly (USA) to Rutten (ECT Chairman) dated 7 September 1994.
RF-259	Press release by Ambassador Eizenstat dated 13 October 1994.
RF-260	Letter from the Canadian delegation to the Energy Charter Conference Secretariat dated 19 March 1992.
RF-261	European Energy Charter Conference Secretariat, Note from the Secretariat 15/93, BA-35 Restricted, regarding Basic Agreement (Article 23) dated 9 February 1993.
RF-262	Memorandum (IEA/OLC(93)26 from Bamberger to Steeg and Ferriter on negotiations of 1-6 February 1993 dated 9 February 1993.
RF-263	Ministry of Economic Affairs, regarding the Report of working group 2 Basic Agreement 22-27 February 1993 (Request made under the Dutch Government Information (Public Access) Act (Wob), Part 4, no. 4[b]) dated 2 March 1993.
RF-264	Yu.A. Tikhomirov, 'The Implementation of International Legal Acts in the Russian Legal System', <i>Russian Law Journal</i> 1999, Nos. 3-4.
RF-265	European Energy Charter Conference Secretariat, report of Clive Jones (Secretary General), Note for the file, subject: visit to Moscow 15-17 June 1993, dated 18 June 1993.
RF-266	Report of (unofficial) negotiations between the Russian Federation and the European Commission.
RF-267	European Energy Charter Conference Secretariat, Message No. 174, Charter Seminar For Parliamentarians September 1993, dated 1 July 1993.
RF-268	Message of Shatalov (Deputy Minister of the Ministry of Fuel and Energy of the Russian Federation) to Maniatopoulos dated 10 October 1994.
RF-269	V. Khvalei, 'Constitutional Grounds for Arbitration and Arbitrability of Disputes in Russia and other CIS Countries', <i>Journal of Eurasian Law</i> 2014.
RF-270	Decision of the Russian Supreme Court in Commercial Matters, No. 11535/13, A40-148581/12 in Case Nos. A40-160147/12, A40-148581/12-25-702 dated 28 January 2014.
RF-271	Resolution of the Seventeenth Commercial Court of Appeal, No. 17AP-4510/11 dated 29 December 2012.
RF-272	Fax from Jones to (i.a.) Weis, Bamberger regarding draft provisional application dated 9 November 1994.
RF-273	T. Gazzini, 'Provisional Application of the Energy Charter Treaty: A Short Analysis of Article 45', <i>Transnational Dispute Management</i> 2010, Vol. 7(1).

UNOFFICIAL TRANSLATION

This text is an unofficial translation of the Dutch original. In case of any discrepancies, the Dutch original shall prevail.

RF-274	Letter from Bamberger (European Energy Charter) to Weis regarding provisional application dated 18 February 1994.
RF-275	Fax from Borek to Weis on provisional application dated 25 February 1994.
RF-276	Letter from Brown (US) to Jones (European Energy Charter) with the subject Conversation with Andrey Konoplyanik, Russian Deputy Minister of Fuels & Energy for internationale zaken) dated 29 April 1992.
RF-277	'Rusland vertraagt energiegemeenschap', <i>Financieele Dagblad</i> dated 11 April 1992.
RF-278	Letter from Jones to Rutten with the subject: Russia Nuclear Trade dated 11 May 1994.
RF-279	letter from Jones to Demarty with the subject: President's meeting with Energy Charter Conference Chairman - 1st June 1993, dated 28 May 1993.
RF-280	'Ook Rusland tekent Energie Handvest', <i>Algemeen Dagblad</i> dated 19 December 1994.
RF-281	'Rusland toch akkoord met energie-pact', <i>Volkskrant</i> , dated 19 December 1994.
RF-282	'Mixed reception awaits Energy Charter in Russia, <i>Financial Times</i> dated 25 November 1994.
RF-283	T. Westerwoudt, 'Russen twijfelen over aangaan vergaande verplichtingen; Ondertekening Energie Handvest', <i>NRC Handelsblad</i> dated 16 December 1994.
RF-284	ECT Draft Annexes T, List of countries' specific transitional measures (version 2) Russia dated 1 May 1993.
RF-285	ECT Draft Annexes T, List of countries' specific transitional measures (List of Countries eligible for Transnational Arrangements)(version 2) dated 1 May 1993.
RF-286	ECT Draft Annexes A, Existing barriers to national treatment (version 2) Russia dated 1 May 1993.
RF-287	ECT Draft Annexes A, Existing barriers to national treatment (List of Countries)(version 2) dated 1 May 1993.
RF-288	European Energy Charter Conference Secretariat, Annexes T (version 4) dated 24 September 1993.
RF-289	European Energy Charter Room document 10 on existing trade barriers - RF Annexes A dated 28 January 1993.
RF-290	Letter from Kemper to Gavrin regarding Request for clarification and advice concerning potential transit dispute with Ukraine, dated 28 June 2000.
RF-291	A.de Gramont en E. M. Alban, <i>The sun never sets: provisional application and the Energy Charter Treaty</i> , in: Graham Coop (ed.) <i>Energy Dispute Resolution: Investment Protection, Transit and the Energy Charter Treaty</i> , 2011.
RF-292	Resolution No. 8 by the Plenum of the Russian Supreme Court in Commercial Matters dated 11 June 1999 (as revised per 27 June 2017).
RF-293	Decision of the Russian Supreme Court, Case No. 5-APU15-68 dated 8 September 2015.
RF-294	<i>Hulley, Yukos Universal and Veteran Petroleum v. Baker Botts</i> , United States District Court for the District of Columbia, Case No. 1:17-mc-01466-BAH dated 18 August 2017.
RF-295	Statement by Godfrey dated 7 June 2016.
RF-296	Judgment of the Brussels Court dated 8 June 2017.
RF-297	'British lawyer hatched Putin smears', <i>Sunday Times</i> dated 14 May 2016.
RF-298	European Energy Charter Conference Secretariat, Room doc. 4 Working Group II, Basic Agreement dated 13 October 1992.
Background	
RF-299	Transcript of the witness statement of Golubovich (first) dated 15 September 2015.
RF-300	Transcript of the witness statement of Golubovich (second) dated 22 September

UNOFFICIAL TRANSLATION

This text is an unofficial translation of the Dutch original. In case of any discrepancies, the Dutch original shall prevail.

	2015.
RF-301	Transcript of the witness statement of Golubovich Muravlenko dated 14 May 2007.
RF-302	United States District court Southern District of New York, <i>Yukos Capital S.A.R.L. v. Daniel Feldman</i> , Case No. 15 Civ. 4964 (LAK) dated 28 September 2016.
RF-303	J. E. Stiglitz, <i>Globalization and Its Discontents</i> , New York: W.W. Norton & Company 2002.
RF-304	B. Gertz, 'Most of Russia's biggest banks linked to mob, CIA report says. Illegal activities spread to District', <i>The Washington Times</i> 1994.
RF-305	'Murder of Petukhov', <i>Kommersant</i> dated 27 June 1998. 'Murder of Petukhov', <i>Moscow Times</i> dated 30 May 1998. 'Petukhov Strike Against Yukos', <i>Moscow Times</i> dated 30 May 1998.
RF-306	Satter's statement on the U.S. Commission on Security and Cooperation in Europe dated 15 January 1999.
RF-307	A. Wierzbicki & P. Rudenko, 'The oil was distilled in real estate. Trust ex-partners in Yukos Khodorkovsky, Lebedev, Dubov and Brudno share capital by \$ 2 billion', <i>Forbes</i> dated 1 April 2015.
RF-308	Press Release, 'Cube Capital. Cube to Focus on Core Hedge Fund Business', dated 13 December 2013.
RF-309	'Russia's 200 Wealthiest Businessmen', <i>Forbes.ru</i> dated 14 April 2016.
RF-310	G. Tanenbaum, 'Quadrum Global Denies Mikhail Khodorkovsky Is One of Its Owners', <i>Jewish Business News</i> dated 22 April 2015.
RF-311	'Investment Group denies Khodorkovsky's Connection with Tbilisi Projects worth \$ 200 Million', <i>Georgian Day</i> dated 22 April 2015.
RF-312	Revised registration Form of the City of Miami Beach Lobbyist dated 6 April 2015.
RF-313	Second revised registration Form of the City of Miami Beach Lobbyist dated 23 December 2015.
RF-314	<i>Bridgewater v. Quadrum</i> , Joint Notice of Removal dated 2 June 2016.
RF-315	NYC Department of Finance Office of the City Register, Filed Deed for 15 E 26th St Unit 20C dated 13 April 2010.
RF-316	Letter from K. Hudson to Shearman & Sterling LLP dated 19 December 2006.
RF-317	Letter from HVY to Fortier, Schwebel and Price dated 3 November 2006.
RF-318	Portfolio, Quadrum Global dated 5 July 2017.
RF-319	'Quadrum Global acquires 32.5-acre property in Fort Myers, FLA.', Press Release of Quadrum Global dated 4 August 2015.
RF-320	SEC Registration Form ADV of Cube Capital LLL dated 26 March 2015.
RF-321	GML Agreement dated 2011.
RF-322	Deposition of Wolf regarding Settlement Negotiations with annex 1, 5 and 6 dated 5 October 2015.
RF-323	<i>Hulley Enterprises Limited, Yukos Universal Limited and Veteran Petroleum Limited v. The Russian Federation</i> , Respondent's First Merits Request For Documents dated 17 June 2011.
RF-324	Declaration of Osborne regarding Foundations minutes dated 21 October 2015.
RF-325	Foundation minutes (San Francisco) (Feldman ECF nr. 62-6) dated 11 September 2008.
RF-326	Foundation minutes (New York) (Feldman ECF nr. 62-5) dated 18 March 2008.
RF-327	Foundation minutes (Houston) (Feldman ECF nr. 62-4) dated 9 March 2010.
RF-328	Foundation minutes (New York) (Feldman ECF nr. 62-2) dated 28 June 2011.
Article 1(6) and 1(7) ECT	
RF-329	E. van der Does de Willebois e.a., Stolen Asset Recovery Initiative, <i>The Puppet</i>

UNOFFICIAL TRANSLATION

This text is an unofficial translation of the Dutch original. In case of any discrepancies, the Dutch original shall prevail.

	<i>Masters: How the Corrupt Use Legal Structures to Hide Stolen Assets and What to Do About It</i> , 2011.
RF-330	Shima Baradaran e.a., <i>Funding Terror</i> , Pennsylvania Law Review 2014, Vol. 162 No. 3.
RF-331	D. H. Fater, <i>Essentials of Corporate and Capital Formation</i> , John Wiley & Sons, Inc. 2010.
RF-332	M. Findley & D.L. Nielson eds. , <i>Global Shell Games: Experiments in Transnational Relations, Crime, and Terrorism</i> , Cambridge University Press 2014.
RF-333	U.S. Money Laundering Threat Assessment, Working Group, December 2005.
RF-334	U.S. Government Accountability Office, <i>Company Formations: Minimal Ownership Information Is Collected and Available</i> , 2006.
RF-335	R. Thorn & J. Doucleff, 'Disregarding the Corporate Veil and Denial of Benefits Clauses: Testing Treaty Language and the Concept of 'Investor'', in: M. Waibel e.a. (eds.), <i>The Backlash Against Investment Arbitration. Perceptions and Reality</i> , Kluwer Law International 2010.
RF-336	A. Alibekova & R. Carrow (eds.), <i>International Arbitration and Mediation – From The Professional's Perspective</i> , Yorkhill Law Publishing 2007.
RF-337	A. Rajput, 'India and investment protection', in: C.L. Lim, <i>Alternative visions of the international law on foreign investment</i> , Cambridge University Press 2016.
RF-338	Anglo-Iranian Oil Co. (<i>United Kingdom v. Iran</i>), Judgment of 22 July 1952, I.C.J. Reports, Advisory Opinions and Orders 1952.
RF-339	<i>Cem Cengiz Uzan v. Republic of Turkey</i> , SCC Case No. V 2014/023, Award on Respondent's Bifurcated Preliminary Objection dated 20 April 2016.
RF-340	<i>Lemire v. Ukraine</i> , ICSID Case No. ARB/06/18, Award dated 28 March 2011.
RF-341	<i>Mihaly International Corporation v. Democratic Socialist Republic of Sri Lanka</i> , ICSID Case No. ARB/00/2, Award dated 15 March 2002.
RF-342	<i>Noble Ventures Inc. v. Romania</i> , ICSID Case No. ARB/01/11, Award dated 12 October 2005.
RF-343	<i>European American Investment Bank AG (Austria) v. The Slovak Republic</i> , PCA Case No. 2010-17, Award on Jurisdiction dated 22 October 2012.
RF-344	<i>Salini Construttori S.P.A. et al. v. Kingdom of Morocco</i> , ICSID Case No. ARB/00/4, Decision on Jurisdiction dated 23 July 2001.
RF-345	<i>Joy Mining Machinery Limited v. The Arab Republic of Egypt</i> , ICSID Case no. ARB/03/11, Award on Jurisdiction dated 6 August 2004.
RF-346	<i>Patrick Mitchell v. The Democratic Republic of Congo</i> , ICSID Case No. ARB/99/7, Decision on the Application for Annulment of the Award dated 1 November 2006.
RF-347	<i>Saba Fakes v. Republic of Turkey</i> , ICSID case no. ARB/07/20, Award dated 14 July 2010.
RF-348	<i>KT Asia Investment Group B.V. v. Republic of Kazakhstan</i> , ICSID Case No. ARB/09/8, Award dated 17 October 2013.
RF-349	<i>MNSS B.V. v. Montenegro</i> , ICSID Case No. ARB(AF)/12/8, Award dated 4 May 2016.
RF-350	E. Gaillard & Y. Banifatemi, 'The Long March towards a Jurisprudence Constante on the Notion of Investment', in: M. Kinneer e.a. (eds.), <i>Building International Investment Law – The First 50 Years of ICSID</i> , Kluwer Law International 2015.
RF-351	<i>Capital Financial Holdings Luxembourg S.A. v. Republic du Cameroun</i> , ICSID Case No. ARB/15/18, Judgment dated 22 June 2017.
RF-352	<i>Energoalliance v. Republic of Moldova</i> , UNCITRAL, Dissenting Opinion of the presiding arbiter Dominic Pellew dated 23 October 2013.
RF-353	<i>Energoalliance v. Republic of Moldova</i> , UNCITRAL, Award dated 23 October

UNOFFICIAL TRANSLATION

This text is an unofficial translation of the Dutch original. In case of any discrepancies, the Dutch original shall prevail.

	2013.
RF-354	<i>Republic of Moldavia v. Komstroy</i> , Cour d'Appel de Paris (Pôle 1, Chambre 1), Ruling dated 12 April 2016.
RF-355	M. Burgstaller, 'Nationality of Corporate Investors and International Claims against the Investor's Own State', 7 <i>The Journal of World Investment and Trade</i> 2006.
RF-356	E.C. Schlemmer, 'Investment, Investor, Nationality, and Shareholders', in: Muchlinski, Ortino & Schreuer (eds.), <i>Oxford Handbook of International Investment Law</i> 2008.
RF-357	<i>Woman v. IOTA Violet and others</i> , High Court of Justice of the Isle of Man - Staff of Government (Appeal Division), Judgment dated 19 August 2016.
RF-358	<i>Logan T/A Hugh Logan Architects v Bent Ham Ltd.</i> , High Court of Justice of the (Isle of Man) Civil Division, Judgment dated 10 August 2011.
RF-359	<i>Kakay v. Frearson & The Dunkled Foundation</i> , High Court of Justice of the Isle of Man - Common Law Division Superior Business, Judgment dated 20 June 2008.
RF-360	V. Djanic, 'In newly unearthed Uzbekistan ruling, exorbitant fees promised to consultants on eve of tender process are viewed by tribunal as evidence of corruption, leading to dismissal of all claims under Dutch BIT', <i>Investment Arbitration Reporter</i> dated 22 June 2017.
RF-361	<i>Metal-Tech Ltd. v. The Republic of Uzbekistan</i> , ICSID Case No. ARB/10/3, Award dated 4 October 2013.
RF-362	<i>Ampal-American Israel Corporation and others v. Arab Republic of Egypt</i> , ICSID Case No. ARB/12/11, Decision on Jurisdiction dated 1 February 2016.
RF-363	<i>David Minnotte and Robert Lewis v. Republic of Poland</i> , ICSID Case No. ARB(AF)/10/1, Award dated 16 May 2014.
RF-364	<i>Oxus Gold plc v. Republic of Uzbekistan</i> , UNCITRAL, Final Award dated 17 December 2015.
RF-365	<i>World Duty Free Co. Ltd. v. The Republic of Kenya</i> , ICSID Case No. ARB/00/7, Award dated 4 October 2006.
RF-366	<i>Société d'Investigation de Recherche et d'Exploitation Minière (SIREXM) v. Burkina Faso</i> , ICSID Case No. ARB/97/1, Award dated 19 January 2000.
RF-367	<i>Teinver S.A., Transportes de Cercanías S.A. and Autobuses Urbanos del Sur S.A. v. The Argentine Republic</i> , ICSID Case No. ARB/09/1, Decision on Jurisdiction dated 21 December 2012.
RF-368	<i>Gustav F W Hamester v. Republic of Ghana</i> , ICSID Case No. ARB/07/24, Award dated 18 June 2010.
RF-369	C.M. Lopez & L. Martinez, 'Corruption, Fraud and Abuse of Process in Investment Treaty Arbitration', in: B. Legum (eds.), <i>The Investment Treaty Arbitration Review. Second Edition</i> . Law Business Research 2017.
RF-370	<i>Mamidoil Jetoil Greek Petroleum Products Societe S.A. v. Republic of Albania</i> , ICSID Case No. ARB/11/24, Award dated 30 March 2015.
RF-371	<i>Blusun S.A., Jean-Pierre Lecorcier and Michael Stein v. Italian Republic</i> , ICSID case no. ARB/14/3, Award dated 27 December 2016.
RF-372	C. Aptel, 'Prosecutorial Discretion at the ICC and Victims' Right to Remedy. Narrowing the Impunity Gap', 10 <i>Journal of International Criminal Justice</i> 1375, 2012.
RF-373	John Ashcroft, Prepared Remarks for the US Mayors Conference dated 25 October 2001.
RF-374	T.E. Zeno, 'A Prosecutor's View of the Sentencing Guidelines', 55 <i>Federal Probation</i> 1991.
RF-375	<i>Fraport AG Frankfurt Airport Services Worldwide v. Republic of the Philippines</i> ,

UNOFFICIAL TRANSLATION

This text is an unofficial translation of the Dutch original. In case of any discrepancies, the Dutch original shall prevail.

	ICSID Case No. ARB/11/12, Award dated 10 December 2014.
RF-376	<i>Armed Activities on the Territory of the Congo (Democratic Republic of the Congo v. Uganda)</i> , Judgment dated 19 December 2005, I.C.J. Reports 2005.
RF-377	<i>The "Kronprins Gustaf Adolf" (Sweden/United States of America)</i> , Award dated 18 July 1932, R.I.A.A. Vol. 2.
RF-378	I. Feichtner, 'Waiver', in: <i>Max Planck Encyclopedia of Public International Law</i> 2006.
RF-379	<i>Certain Phosphate Lands in Nauru (Nauru v. Australia)</i> , Preliminary Objections, Judgment dated 26 June 1992, I.C.J. Reports 1992.
RF-380	<i>Waste Management Inc. v. United Mexican States I</i> , ICSID Case No. ARB(AF)/98/2, Arbitral Award dated 2 June 2000.
RF-381	<i>Island of Palmas Case (Netherlands v. U.S.A.)</i> , Award dated 4 April 1928, R.I.A.A. Vol. II, pp.
RF-382	<i>Case of Certain Norwegian Loans (France v. Norway)</i> , Judgment dated 6 July 1957, I.C.J. Reports 1957.
RF-383	<i>Russian Claim for Interest on Indemnities (Russia v. Turkey)</i> , PCA, Award dated 11 November 1912, Scott's Hague Court Reports.
RF-384	B. Cheng, <i>General Principles of law. As applied by International Courts and Tribunals</i> , Cambridge University Press 2006.
RF-385	<i>United States v. La Abra Silver Mining Co</i> , 32 United States Court of Claims 462, Decision dated 24 June 1897.
RF-386	<i>United States v. Weil</i> , 32 United States Court of Claims 42, Decision dated 3 January 1900.
RF-387	<i>La Abra Silver Mining Co. V. United States</i> , 175 Supreme Court of the United States 423, Decision dated 11 December 1899.
RF-388	<i>Lehigh Valley Railroad Company, Agency of Canadian Car and Foundry Company, Limited, and Various Underwriters (United States) v. Germany (Sabotage Cases)</i> , Opinion dated 15 June 1939, R.I.A.A. Vol. VIII.
RF-389	<i>Ram International Industries v. Air Force of Iran</i> , Iran-United States Claims Tribunal Reports 1993, Vol. 29.
RF-390	<i>Anatolie Stati and others v. The Republic of Kazakhstan</i> , EWHC 1348 (Comm), Decision dated 6 June 2017.
RF-391	<i>République du Kirghizistan v. M. Valriy Belokon</i> , Cour d'Appel de Paris (Pôle 1, Chambre 1), Judgment dated 21 February 2017.
RF-392	<i>Inceysa Vallisoletana, S.L. v. Republic of El Salvador</i> , ICSID Case No. ARB/03/26, Award dated 2 August 2006.
RF-393	<i>Koza Limited, Hamdi Akin Ipek v. Koza Altin</i> , EWHC 2889 (Ch) 2017, Judgment dated 16 November 2017.
Assistant of the Tribunal	
RF-394	Letter from Fortier (Explanations) dated 20 November 2015.
RF-395	Queen Mary en White & Case International Arbitration Survey 2015.
RF-396	T. Giovannini, 'Le Nouveau Reglement Suisse d'arbitrage international', <i>Gazette du Palais</i> , 2004, No. 2004/2.
RF-397	C. Thomas, 'Le secrétaire arbitral', <i>Revue de l'Arbitrage</i> 2005, Issue 4.
RF-398	'Joint Report of the International Commercial Disputes Committee and the Committee of Arbitration of the New York Bar association', <i>The American Review of International Arbitration</i> , 2006/Vol. 17, No. 4.
RF-399	G. Keutgen en G.A. Dal, 'L'Arbitrage et Droit Belge et international', 2006.
RF-400	F. Schwarz & C. Konrad, 'The Vienna Rules: A commentary on International Arbitration in Austria', <i>Kluwer Law International</i> 2009.

UNOFFICIAL TRANSLATION

This text is an unofficial translation of the Dutch original. In case of any discrepancies, the Dutch original shall prevail.

RF-401	J. Menz, 'Miss Moneypenny vs. The Fourth Musketeer: The Role of Arbitral 'Secretaries'', <i>Kluwer Arbitration Blog</i> dated 9 July 2013.
RF-402	M. Fontaine, 'L'arbitre et ses collaborateurs', <i>b-Arbitra</i> 2013/1.
RF-403	Z. Douglas, 'The Secretary to the Arbitral Tribunal', in: <i>Inside the Black Box: How Arbitral Tribunals Operate and Reach Their Decisions</i> , <i>ASA Special Series</i> No. 42, 2014.
RF-404	K.P. Berger, Part III, 27th Scenario: 'Deliberation of the tribunal and Rendering of the Award', <i>Private Dispute Resolution in International Business, Negotiation, Mediation, Arbitration (Third Edition)</i> , Third Revised Edition, <i>Kluwer Law International</i> 2015.
RF-405	R. Gerbay & L. Richman et al., 'Arbitrating under the 2014 LCIA Rules: A User's Guide', <i>Kluwer Law International</i> 2015.
Public Policy	
RF-406	<i>République de Madagascar v. De Sutter</i> , Cour D'Appel de Paris (Pôle 1, Chambre 1), Judgment dated 15 March 2016.
RF-407	<i>République de Madagascar v. De Sutter</i> , Cour de Cassation, Judgment dated 20 June 2017.
RF-408	<i>République de Guinée Equatoriale v. Orange Middle East and Africa</i> , Cour d'Appel de Paris, Judgment dated 22 September 2015.
RF-409	<i>Soleimany v. Soleimany</i> , <i>Arbitration, Practice & Procedure Law Reports</i> , 02/19 dated 19 February 1998.
RF-410	<i>Belokon v. Kyrgyzstan</i> , UNCITRAL, Judgment dated 24 October 2014.
Miscellaneous topics	
RF-411	'Former Vice-President of YUKOS Vasily Aleksanyan was buried in Khovanskoye Cemetery', <i>Obshchaya Gazeta</i> dated 7 October 2011.
RF-412	'Aleksanyan is discharged from Hospital', <i>BBC Russian.com</i> dated 16 January 2009.
RF-413	<i>BC Group Plc v. Republic of Argentina</i> , 572 U.S. Supreme Court, Decision dated 5 March 2014.
RF-414	<i>NML Capital v. Republic of Argentina</i> , Supreme Court of Ghana, Decision dated 20 June 2013.
RF-415	Letter from GML Limited International Advisory Board to Khamovniki District Court of Moscow dated 3 November 2009.